



# TOOLS

## ACID & FLUID BOTTLES

### Acid & Fluid Glass Bottles

#### Acid Bottle (Round) with Dipper

Round Acid Glass Bottle with Dipper

Has a sealable plastic lid incorporating a paddle applicator. Ideal for storing/testing your testing solutions.

- Ø22mm
- With Acid Proof Dipper

Code	Description	UOM	Price
A31884	Acid Bottle (Round) with Dipper	EACH	£1.50



#### Acid Bottle (Round) with Applicator

Round Acid Testing Glass Bottle

Completely made from glass with applicator included in the closing cap. Ideal for storing/testing your testing solutions

- Round acid bottle with dipper
- Weight 50gms
- Capacity 20ml
- Ø32mm

Code	Description	UOM	Price
S39266	Acid Bottle (Round) with Applicator	EACH	£1.25



#### Acid Bottle (Square) with Applicator

Square Acid Testing Glass Bottle

Completely made from glass with applicator included in the closing cap. Traditional acid bottle, ideal for storing/testing your testing solutions.

- Square acid bottle with dipper
- Weight 50gms
- Capacity 20ml
- 24 x 24mm

Code	Description	UOM	Price
B19163	Acid Bottle (Square) with Applicator	EACH	£1.50



#### Fluid Bottle with Cork (50 x Ø25mm)

Glass Bottles with Corks

Perfect for storing beads or small objects and innocuous fluids.

- Ø25 x 50mm

Code	Description	UOM	Price
B45694	Fluid Bottle with Cork (50 x Ø25mm)	EACH	£1.50



#### Fluid Bottle with Cork (75 x Ø25mm)

Glass Bottles with Corks

Perfect for storing beads or small objects and innocuous fluids.

- Ø25 x 75mm

Code	Description	UOM	Price
B45695	Fluid Bottle with Cork (75 x Ø25mm)	EACH	£1.75



## ALLEN KEYS AND NUT (SOCKET) DRIVERS

#### Allen (Hex) Keys, Individuals



Allen (Hex) Keys - Individuals

- Swiss Made
- Chromed handle with knurled grip
- Hole for tommy bar

Code	Description	UOM	Price
A0003	Ø1.50mm, Mauve Male Allen Key	EACH	£5.85
A0004	Ø2.00mm, Green Male Allen Key	EACH	£5.85
A0005	Ø2.50mm, Blue Male Allen Key	EACH	£5.85
A0006	Ø3.00mm, Brown Male Allen Key	EACH	£5.85

#### Allen (Hex) Keys, Set



Allen (Hex) Keys - Male - Sets

This quality Eklind Fold-Up Key Set is the Industry Standard and manufactured using fine quality alloy steel. It is hardened, tempered and finished to resist rust. All Eklind keys meet or exceed ANISI B18, 3 ABD Fed. Spec GGG-k-275D.

Sizes:

Set of 7 keys sizes: 1.5mm, 2.0mm, 2.5mm, 3mm, 4mm, 5mm & 6mm

Weight: 140g

Code	Description	UOM	Price
K33519	Hexagonal Key Set	PACK*7	£4.85

#### Nutdriver (Socket) Set



Allen (Hex) Keys - Female (Nutdrivers)

- A\*F Swiss
- Chromed handle with knurled grip
- Hole for tommy bar

Set Includes:

- Grey = Ø3.00mm
- Mauve = Ø3.50mm
- Green = Ø4.00mm
- Blue = Ø4.50mm
- Brown = Ø5.00mm

Code	Description	UOM	Price
A0007	Female Allen Key Set	PACK*5	£29.25
A40291	Ø3.00mm (Grey)	EACH	£6.75
A40292	Ø3.50mm (Mauve)	EACH	£6.75
A40293	Ø4.00mm (Green)	EACH	£6.75
A40294	Ø4.50mm (Blue)	EACH	£6.75
A40295	Ø5.00mm (Brown)	EACH	£6.75



### WORLDWIDE DELIVERY



### Online Discounts

## BANGLE & BRACELET TOOLS

In recent years the public interest in bangle and bracelet fashions has glamorously resurged, particular with the growth of the Pandora and Chamilia brands. Bangles and bracelets can come in variable shapes and sizes and we stock a wide selection of tools and equipment for all sizing, manufacturing, wholesaling and retailing needs.

Take this opportunity to design and manufacture your own Churi range to capitalise on a rapidly growing industry.

### Sizing:

We also have a selection of bangle & bracelet gauges for measuring customer's wrists. We also stock two types of internal measuring bangle / bracelet gauges, for measuring a bangle when a customer supplies a sample.

There are two styles of gauges available for measuring bangle sizes, the adjustable band gauge the 'belt gauges and a set of individual measuring bands, similar to a ring gauge. When sizing a customer's bangle size have them touch thumb to little finger and then size, this contracts the human hand smaller thus allowing the gauge to slip over the wrist easily.

### Diameter Gauge, Acrylic

Bangle & Bracelet Measuring Gauge

- Place bangle/bracelet over the gauge to find out its diameter
- Acrylic
- Flat strip, easy storage and use
- Inches and millimetres
- Overall size 155 x 80mm

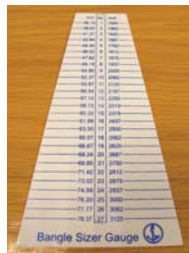

Code	Description	UOM	Price
G45828	Bangle Diameter Gauge, Acrylic	EACH	£1.95

### Diameter Gauge, Steel



Bangle & Bracelet Measuring Gauge

- Place bangle/bracelet over the gauge to find out its diameter
- Steel
- Flat strip, easy storage and use
- Inches

- Overall size 95 x 80mm

Code	Description	UOM	Price
G45827	Bangle Diameter Gauge, Steel	EACH	£2.95

### Diameter & Circumference Gauge, Aluminum

Bangle & Bracelet Measuring Gauge

Very popular, simply place the item on and read off the sizes marked on the unit. Scale on one side indicates the diameter of the bracelet / bangle and on the other, the corresponding circumference.

- In aluminum with grey anodised body.
- Total height 270mm
- Waist diameter 100mm
- Diameter Ø38 to 70mm
- Circumference 120 to 220mm
- O.M.O Italy



Code	Description	UOM	Price
G6529	Bangle Diameter & Circumference Gauge, Aluminum	EACH	£49.95

### Diameter & Circumference Gauge, Steel

Bangle & Bracelet Measuring Gauge

- Will measure both the circumference and diameters of bracelets & bangles in millimetres
- Sits on your workbench
- Has a hollow cavity for storage and easy access to tools
- Overall height 110mm



Code	Description	UOM	Price
G45826	Bangle Diameter & Circumference Gauge, Steel	EACH	£16.95

### Diameter & Circumference Gauge, Plastic Paper



Bangle & Bracelet Measuring Gauge

- Allows the measurement of bangles / bracelets of different forms
- Plastic coated paper sheet
- Supplied flat, but when rolled and stuck with adhesive strip forms cone on which bracelets are placed and measured
- Capacity 120 to 220mm
- Overall height 255mm

- Bergeon 6466

Code	Description	UOM	Price
G6992	Bangle Diameter & Circumference Gauge, Plastic Paper	EACH	£8.25

### Wrist Measuring (Band) Gauge, Imperial



Bangle belt measurements are marked on the gauge in imperial circumferences.

- Bangle Gauge Imperial Sizes
- In nicked steel
- Width: 16mm
- For adults and children's measurements
- 16 size marked slots: 5, 5¼, 5½, 5¾, 6, 6¼, 6½, 6¾, 7, 7¼, 7½, 7¾, 8, 8¼, 8½ & 8¾"

Code	Description	UOM	Price
G5349	Wrist Measuring (Band) Gauge, Imperial	EACH	£4.95

### Wrist Measuring (Band) Gauge, Metric



Bangle belt measurements are marked on the gauge in metric circumferences.

- Bangle Gauge Metric Sizes
- In nicked steel
- Width 16mm
- For adults and children's measurements
- 9 size marked slots: 15, 16, 17, 18, 19, 20, 21, 22 and 23cm

Code	Description	UOM	Price
G5350	Wrist Measuring (Band) Gauge, Metric	EACH	£4.40

### Wrist Measuring (Rings) Gauge, Metal



This Bangle gauge has 27 individual bangle rings marked with numbers 1 to 27. Try the different bangles

## BANGLE & BRACELET TOOLS

until the suitable size is found, measure across the inner diameter of the metal bangle size and multiply by 3.14 which will give the circumference. For example the number 27 gauge is 79mm diameter multiplied by 3.14 gives the circumference as approximately 248mm.

Each ring has a number marked on it, below are the corresponding sizes, diameter (Ø) and circumference (C):

1. Ø38, C119mm, 2. Ø39, C122mm
3. Ø40, C125mm, 4. Ø42, C131mm
5. Ø44, C138mm, 6. Ø45, C141mm
7. Ø47, C147mm, 8. Ø48, C150mm
9. Ø50, C157mm, 10. Ø51, C160mm
11. Ø53, C166mm, 12. Ø54, C169mm
13. Ø56, C175mm, 14. Ø58, C182mm
15. Ø59, C185mm, 16. Ø61, C191mm
17. Ø63, C197mm, 18. Ø65, C204mm
19. Ø66, C207mm, 20. Ø67, C210mm
21. Ø69, C216mm, 22. Ø70, C219mm
23. Ø72, C226mm, 24. Ø74, C232mm
25. Ø75, C235mm, 26. Ø77, C241mm
27. Ø79, C248mm

Code	Description	UOM	Price
G20125	Wrist Measuring (Rings) Gauge, Metal	EACH	£14.95

### Wrist Measuring (Rings) Gauge, Plastic



An inexpensive plastic coated bracelet gauge for travelling sales people or to give out to customers to determine their own sizes. Calculating this helps during the making or ordering process particularly with postal orders.

- Plastic
- Inexpensive if lost or stolen
- Inch size on each band
- From 2" to 2.7"
- 15 sizes

How to size:

Bangle size is measured around the largest part of a closed hand. This measurement can be in inches or centimetres. Cuff, soft and I.D type bracelets' measurements are taken from around the wrist, which ensures they fit comfortably.

Code	Description	UOM	Price
G39464	Bangle Gauge, Plastic	EACH	£3.95

**PRICE PROMISE  
GUARANTEE**



### Bangle & Bracelet Gauges

See Page 772



### Bangle/Bracelet Holders

Working with bangles and bracelets need not to be awkward while your mounting stone setting engraving texturing and polishing.

- Handy holding devices are excellent for the manufacturing workshop
- Available in light weight wooden and sturdy aluminium

#### Bangle & Bracelet Holder, Aluminium



Aluminium light weight sturdy holder for bracelets/bangles

- Undo the 6 Hex screws and secure your work ready for polishing, diamond milling, engraving, texturing etc.
- Have complete control while polishing giving you a uniform finish and no chance of bracelet twisting or knotting.
- No need to melt shellac to secure items, fasten your production rate saving money and time.
- Holds up to 8mm thick bracelets/bangles
- Ø90mm overall width
- With Hex key

Size: Ø90mm x 20mm  
Weight: 220 grams

Code	Description	UOM	Price
B34940	Bangle & Bracelet Holder, Aluminium	EACH	£8.95

#### Bangle & Bracelet Rotation Wooden Holder



Bangle and Bracelet rotation wooden holder is lightweight and easily controllable.

Secure in a vice and unscrew the wing nut and remove the washer, take the wooden wheel from the handle, melts some shellac (S31924) on the wheel and secure the item to be polished.

Once the shellac has solidified around the bracelet or chain the user can tighten and loosen the wing nut to turn the piece allowing a concentrated, safer and easier way of polishing. Simply apply low heat to melt the Shellac once finished polishing.

You can also use this tool to secure your stone setting with shellac so it is easier to work on.

- Size: 240mm x 75mm x 40mm
- Diameter of rotation disc holder 80mm
- Weight: 190g

Code	Description	UOM	Price
B20861	Bangle & Bracelet Rotation Wooden Holder	EACH	£4.35

### Wooden Holder for Bracelets and Chains



Wooden Holder for Bracelets and Chains is made from lightweight wood and makes polishing safer and easier. Place your item in the special cut out groove and hold the Wooden Holder through the centre hole. The tool enables a uniform polish safely and easily with no twisting and knotting as well as giving complete control.

Handy tip...

You can also hold you're your bracelet so you can repair or make intricate stone settings.

Melt some shellac (S31924) into the groove and secure your bracelet ready to work on.

- Size: 85mm x 55mm x 20mm
- Weight: 40g

Code	Description	UOM	Price
H31869	Wooden Holder for Bracelets and Chains	EACH	£5.95

### Stretcher (Bangles) - Indian



This is a well-engineered bangle stretcher, and fantastic value for the price.

- Sturdy steel construction
- Easy action smooth 4 lever rotating base head
- Fine size increments embossed on the unit giving accuracy whilst bangle stretching
- Seven parallel stretching steps with twenty six separate openings giving an extremely accurate and even opening action
- Cast iron base with 3 locating bolt/screw mounting holes (bolts/screws not supplied)

Step sizes:

- Step 1 Ø40 to 45mm
- Step 2 Ø50 to 55mm
- Step 3 Ø55 to 60mm
- Step 4 Ø65 to 70mm
- Step 5 Ø70 to 75mm
- Step 6 Ø75 to 80mm
- Step 7 Ø80 to 85mm

Overall size: 500 x 230mm

Weight: 20kg

Code	Description	UOM	Price
B36313	Stretcher (Bangles) - Indian	EACH	£230.00



**SAME DAY DISPATCH**

**Stretcher (Bangles) - Italian**



Made in Italy (O.M.O)

Like our Wedding Ring Enlarging Tool (R5193/R31945) this tool comprises an essential part of both retail and manufacturing environments, allowing the user to stretch a bangle up to one size. Pre-made bangles can be stretched quickly and easily without any technical knowledge and while the customer waits. This tool is often used to alter a bangle prior to sale to an individual customer and further as a walk in service.

This unit comes complete with a set of six round dies. Additionally oval dies (B5195) are available to buy separately which are just as popular. Do remember the human wrist is oval in shape hence the ergonomic benefits of this set.

- Strong robust cast iron body construction can last a life time with the correct maintenance;
- Save time and money by not remaking or reordering;
- Easily interchangeable set of six round dies, with wooden stand;
- Each die has six segments giving an even stretch.

Size:

Bangle stretcher - 360mm x 130mm x 180mm  
Round die formers on stand - 100mm x 150mm x 250mm

Sizes of enlargers: Top Ø x Bottom Ø  
45mm x 40mm, 50mm x 45mm  
55mm x 50mm, 60mm x 55mm  
65mm x 60mm, 70mm x 65mm

Weight: 14kg

Code	Description	UOM	Price
B5194	Stretcher (Bangles) with 6 Round Formers	EACH	£495.00
B5195	Oval Formers Set	PACK*6	£395.00

**BEADING, STRINGING & THREADING TOOLS**

**Beading Needles**



A handy tool which is great for knotting cord, picking, probing, and wax carving/detailing

- This tool is used to help slide a knot into place when knotting between your beads
- It can also help knotting down into the cup of a bead tip. It is very difficult to coax a knot to fit snugly into position
- Without the aid of this tool the task can be nearly impossible
- This tool is great for untying knots, picking thread and other stuff out of bead holes, knotting pearls, making holes in leather and cloth
- Also great for wax work and detailing

N34926

- Quality steel construction
- Knurled centre grip
- Fine pointed
- Length 160mm
- Weight 22g

B39056

- Fine, steel point
- Comfortable wooden handle
- Length 150mm
- Weight 20g

Code	Description	UOM	Price
N34926	Beading Needle	EACH	£0.95
B39056	Beading Needle, Wooden Handle	EACH	£0.95

**Bead Clamp Levers, Wooden**



Hold beads & rings easily with these wooden bead clamp levers. Featuring 5 different diameter holes or clamps for holding your beads and rings. Made from wood to prevent any damage to your delicate items, these levers make your beads easy to handle, move and work with.

- 3 hole diameters: Ø4, 8, 12mm
- 2 clamp diameters: Ø8 & 12mm
- Spring loaded
- Wooden

Code	Description	UOM	Price
P39565	Bead Clamp Levers, Wooden	EACH	£3.95

**Bead Opener Awl**



Ever had a problem trying to cover a crimp with a bead? Then look no further. The Designer Bead Opener Awl is specifically made to ream out beads, so the opening is wide enough to cover the crimp inside it.

All you have to do is place the awl into your bead, place it into the clear acrylic block, push/ream to open the bead.

Remove, flip, and insert into the other bead hole to fully open the bead.

Cover a crimped connection with the opened base and carefully close with chain nosed (code P4780) or bead crimping pliers (code P35078).

Once covered the connection disappears into your jewellery designs

- Steel construction with soft comfortable plastic handle

Length: 150mm - acrylic block size 25mm square  
Weight: 55 grams

Code	Description	UOM	Price
B34928	Bead Opener Awl	EACH	£5.95

**Bead Organising Sieves**



Excellent tool for quickly and easily sorting your beads into sizes

- Tough, transparent acrylic material
- 8 size sieves
- Box shaped, easy to store and transport
- 350g

Sieve size diameters:

• Ø2.5 - 3.5 - 4.5 - 5.5 - 6.5 - 7.5 - 8.5 - 9.5mm

Code	Description	UOM	Price
B39054	Bead Sorting Box	EACH	£18.95

**3 Groove Bead Stringing Board**



Great organisational and practical tools. They serve to organise your beads as well as aligning them prior to stringing.

- Wooden, black finish
- 3 Bead grooves, Ø13mm
- 1 groove for storing needles etc
- 390 x 95 x 15mm

Code	Description	UOM	Price
B39052	3 Groove Bead Stringing Board	EACH	£5.95

**6 Groove Bead Stringing Board**



Great organisational and practical tools. They serve to organise your beads as well as aligning them prior to stringing.

- Wooden, gloss finish
- 6 Bead grooves, up to Ø9mm
- 520 x 105 x 15mm

Code	Description	UOM	Price
B39053	6 Groove Bead Stringing Board	EACH	£6.95

**Bead Tray for Size 2 to 3mm**



- Capacity 100 Beads
- Size: 160mm x 80mm x 25mm
- Weight 80grms
- Light weight nylon plastic
- Lift up carry handle included no chance of beads getting mixed up when Beading Boards Organizers are put into storage
- Full range of sizes available
- Available in white

Code	Description	UOM	Price
T31253	Bead Tray for Size 2 to 3mm	EACH	£14.95

**Bead Tray for Size 4 to 5mm**



- Capacity 100 Beads
- Size: 110mm x 80mm x 25mm
- Weight 80grms
- Light weight nylon plastic
- Lift up carry handle included no chance of beads getting mixed up when Beading Boards Organizers are put into storage
- Full range of sizes available
- Available in white

Code	Description	UOM	Price
T31254	Bead Tray for Size 4 to 5mm	EACH	£14.95

**Bead Tray for Size 6 to 7mm**

- Capacity 50 Beads
- Size: 110mm x 80mm x 25mm
- Weight 80grms
- Light weight nylon plastic
- Lift up carry handle included no chance of beads getting mixed up when Beading Boards Organizers are put into storage
- Full range of sizes available
- Available in white

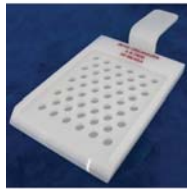

- 330mm x 245mm
- Radiuses Bead Organising Tray
- Flocked Designer Beading Board
- Lay out up to 3 strands
- Maximum length 34 inches on this flocked plastic board
- The high quality grey flocking reduces eyestrain and keeps your beads in place
- Marked in 1/2 inch and 1 inch increments
- 6 compartments useful for storing beads and small tools
- Weight: 90gms

Code	Description	UOM	Price
T31875	Bead Organising Tray 6 Compartments 3 Strands	EACH	£4.15

**Bead Organising Plastic Board**



**Bead Tray for Size 8 to 10mm**

- Capacity 50 Beads
- Size: 210mm x 90mm x 25mm
- Weight 120grms
- Light weight nylon plastic
- Lift up carry handle included no chance of beads getting mixed up when Beading Boards Organizers are put into storage
- Full range of sizes available
- Available in white



Code	Description	UOM	Price
T31255	Bead Tray for Size 6 to 7mm	EACH	£14.95

**Bead Organising Tray 6 Squares & 4 Grooves**



- 540mm x 205mm
- Flocked Designer Beading Board
- Design multi strand necklaces up to 20inch long with this four row board
- Flocked grey surface reduces eye strain
- Marked in 1/2 inch increments
- Six compartments useful for storing beads and small tools
- Weight 135gms

Code	Description	UOM	Price
T31874	Bead Organising Tray 6 Squares & 4 Grooves	EACH	£6.20

**Bead Organising Tray 6 Compartments 3 Strands**



- Flock Velvet

- Black Plastic
- 330mm x 220mm
- Radiuses Bead Organising Tray
- Lay out one strand
- Maximum length 24 inches
- High quality black plastic so you can see those coloured beads clearly
- Marked in 1/2 inch and 1 inch increments,
- 5 compartments useful for storing beads and small tools
- Weight: 150gms

Code	Description	UOM	Price
B31873	Bead Organising Plastic Board	EACH	£4.10

**Tray for Sorting Beads and Gemstones**



Sorting tray is used to sort stones, diamonds and pearls etc. It has various shapes of grooves and lines to aid efficient sorting.

Code	Description	UOM	Price
T20121	Tray for Sorting Beads and Gemstones	EACH	£3.05

***Bead Reamers, Diamond Impregnated***

Not all bead holes are produced equal because, believe it or not, most of them are manually drilled. Everybody has had the perfect bead for the project, but the hole is either too small, or there is debris stopping your stringing material from passing through. These reamer sets are ideal tools to combat this problem saving you time and money.

- Available in high quality A\*F Swiss or Indian made which for the price is exceptional value
- Smoothens and standardizes holes for ceramic beads, pearls, glass, stone and metal
- For reaming stones and beads always use water as a lubricant with diamond instruments

**Diamond Coated Reamer Set**



- Set of 3 diamond coated bead reamers
- Small reaming point
  - Large reaming point
  - 45 degree edging point
  - Shank Ø3mm
  - Made in India

Code	Description	UOM	Price
R34925	Diamond Coated Reamer Set	PACK*3	£3.95

**Diamond Coated Reamer Set, with Handle**



- Set of 4 diamond coated burrs
- Flat Reaming Pillar
- Small Reaming Point
- Large Reaming Point
- 45 Degree Edging Point
- Shank Ø3mm
- Handle Ø10mm
- Made in India

For reaming stones and beads, always use water as a lubricant with diamond instruments

Code	Description	UOM	Price
B20120	Diamond Coated Reamer Set, with Handle	PACK*4	£11.35



**Balls, Beads and Decorative Items**

See Page 10

**Bead Sorter/ Diamond Sieve**

See Page 925

**Diamond Coated Reamer Set, with Handle - A\*F Swiss**



- A\*F Swiss  
Set of 3 diamond coated burrs
- Small Reaming Point
  - Large Reaming Point
  - 45 Degree Edging Point
  - Shank Ø3mm
  - Handle Ø16mm

For reaming stones and beads, always use water as a lubricant with diamond instruments.

Code	Description	UOM	Price
B4382	Diamond Coated Reamer Set, with Handle - A*F Swiss	PACK*3	£10.85

**Diamond Coated Reamer Set, with Handle - Wooden**



- Set of 2 diamond coated burrs
- Reaming Point
- 45 Degree Edging Point
- Shank Ø3mm
- Handle Ø30mm
- Made in India

For reaming stones and beads, always use water as a lubricant with diamond instruments.

Code	Description	UOM	Price
R39057	Diamond Coated Reamer Set, with Handle - Wooden	PACK*2	£4.95

**Bead Reamer, Electric**



Let the reamer do the work!

- Effortlessly smooth the rough edges of beads
- Perfect for easily enlarging holes in beads and pearls
- Compact & lightweight design
- Includes 3 diamond coated reamers; small, large & 45° reamer
- Variable speed control, 1000 to 20,000 RPM (rotations per minute)
- 240 Volt, mains operated
- Pro Electric Bead Reamer

Code	Description	UOM	Price
B48830	Bead Reamer, Electric	EACH	£16.95

**Bead Scoop**



- Easily pick up and move beads of all sizes
- Particularly effective at picking up tiny beads and putting them into a tube
- Pointed, concave end for ease of use
- Stainless steel
- 16cm long

Code	Description	UOM	Price
B45693	Bead Scoop	EACH	£1.25

**Bead Spinner**



This simple yet ingenious tool is excellent for mixing and threading your seed beads into amazing and bright colours without the long task of threading each individual bead.

This little bead spinner saves a lot of hand and eye strain as well as time!

How to use:

- Place your selected colour(s) of seed bead into the basin of the spinner.
- If you are using different colours they will mix together when the basin is spun.
- Now take your beading wire or memory wire and make a slight bend in the end to mimic the contour of the inside of the basin.
- Now using the grip at the end of the spinner shaft, spin the basin round in an anti-clock wise direction.
- Keep doing this to keep the basin spinning at a regular medium pace.
- As the basin is spinning insert the curved end of your wire into the spinning beads.
- You will notice the beads start to jump onto the end of your wire!
- Quickly you will find that you have threaded the whole wire in no time at all, forming eye catching random bead patterns!.
- Saving time and eye strain this a must for all seed beaders!

Weight: 251g

Basin opening: 80mm

Code	Description	UOM	Price
B35077	Bead Spinner	EACH	£7.95

**Bead Stoppers**



These spring or bead stoppers grip the end of pretty much any thread and stops your beads from falling off. This gadget works with all types of thread like stretch

magic, beadalon and nymo and it hasn't affected the thread in anyway (like kinking or weakening the thread at the point where it grips).

These bead stoppers are easy to use, just pinch the two wing loops together to expand the spring to enable you to place your thread/threads between the springs. No more messing around with stopper beads or using sticky tape.

- Pack 12
- With rubber handles for better grip and protection
- Spring length: 12mm
- Spring overall diameter: Ø10mm
- Spring wire diameter: Ø1.10mm
- Wing size: 15 x 12mm

Dimensions are approximate

Code	Description	UOM	Price
B45692	Bead Stopper Springs	PACK*12	£6.95

**Bead Stringing Spiral Needles**



Eye Beading & Stringing Spiral Needles for Beads, Pearls etc.

- These collapsible eye needles are flexible and are particularly nice for stringing beads that have very small holes or for stringing beads onto ribbon.
- Extra-spring wire is kink-resistant and has a specially designed eye that automatically collapses and instantly reshapes when it is pulled through the bead.
- The eye makes it easy to thread and accommodates many sizes of thread cord wire etc.
- Depending on the tightness of the bead leading hole, lock the thread wire or cord and tighten with a pair of pliers; knot the thread in the eye or thread and push the malleable needle in through the bead thus locking the thread in the eye, continue to bead.

In bags of 25pcs available in Various diameters.

- Fine, medium & thick
- Diameter is the wire twisted together

Code	Description	UOM	Price
J9771A	Ø0.25mm Fine Needles, A*F Swiss	PACK*25	£8.95
J33129	Ø0.25mm Fine Needles, Non EU	PACK*25	£3.95
J9771B	Ø0.35mm Medium Needles, A*F Swiss	PACK*25	£8.95
J33130	Ø0.40mm Medium Needles, Non EU	PACK*25	£3.95
J9771C	Ø0.50mm Thick Needles, A*F Swiss	PACK*25	£8.95
J33131	Ø0.60mm Thick Needles, Non EU	PACK*25	£3.95

**Beading Wire End Rounder**



The Designer Wire Rounder has a small cup burr at its tip that rounds wire ends.

- Place the end of any size coloured wire, silver, gold copper brass etc. into the cup, push the two firmly together moving left to right twist the tool against the wire for a smooth round end.
- With traditional wooden handle
- Maximum size wire can be rounded Ø1.20mm
- Length 140mm

Code	Description	UOM	Price
W34930	Wire End Rounder Tool	EACH	£3.95

## BEAT SETTING, PIVOT & HAIRSPRING TOOLS, CLOCK

### Beat Setting (Clock) Tool, Horolovar



- For 400 day anniversary clocks

With this tool, the final and most important operation in a 400 day clock repair, is putting the pendulum in beat.

This becomes simple, quick, accurate and permanent, moreover it can be used on any model 400 day clock suspension saddle, old or new.

This precision tool is expressly designed to make the day to day life of a clock repairer easier and more profitable.

Code	Description	UOM	Price
T5058	Horolovar Beat Setting Tool	EACH	£16.95

### Clock Hairspring Holder

Clock Hairspring Holder

- Simple basic tool for holding hairspring whilst adjusting or amending
- Weight 10g



Code	Description	UOM	Price
H31258	Clock Hairspring Holder	EACH	£3.75

### Large Clock Pivot Locating Tool



- Clock Pivot Locating Tool
- 190mm (7½") Overall Length (including wooden handle)
- Reach for larger stubborn pinions

Code	Description	UOM	Price
P8784	Large Clock Pivot Locating Tool	EACH	£2.90

### Standard Clock Pivot Locating Tool



- Clock Pivot Locating Tool
- 160mm (6¼") Length
- Reach for general use throughout the clock train

Code	Description	UOM	Price
P8783	Standard Clock Pivot Locating Tool	EACH	£2.65

### Pivot Rounding Tool

- Bergeon 5482
- For dressing pivot tips on balance staffs



Code	Description	UOM	Price
P1227	Pivot Rounding Tool	EACH	£37.95

## BLOWERS & VACUUM PUMP

*Dust Blowers are an essential tool when repairing or changing watch batteries and movements. By squeezing or pressing the dust blower natural air is recycled and blown into small areas to disperse dust particles from the watch. Always avoid blowing onto the movement yourself, this can deposit moisture into the watch and cause problems later.*

*There is always a chance fine particles or dust can get into the watch movement so it is always essential to use a Dust Blower. We have a large selection of dust blowers comprised of various shapes and materials.*

- Rubber blowers hold more natural air and when pressed will push out air faster with very little pressure.
- The Bakelite is finer and smaller for more accurate cleaning to enter awkward areas and clean.

### Compressed Air, 5 Star



Dust Blower - Compressed Air

- Compressed Air Cleaner
- Made UK
- Supplied with special long nozzle for reaching parts normally inaccessible
- An ecological and ozone friendly product
- Contains no CFC or HCFC and is a none toxic, non carcinogenic and recyclable
- Contains: 400ml
- Weight: 350g

Compressed Air is an excellent medium to clean mechanical and quartz watches. Practically suitable for cleaning digital displays, dials, glasses and difficult to reach areas. It is also ideal for computers, optics, precision, instruments, audio-visual and laboratories.

Instructions for use:

Hold vertically during use. Do not shake. Position the nozzle approximately 10cm from the object.

Code	Description	UOM	Price
A38766	Air Cleaner, Compressed Air	EACH	£3.25

### Bakelite, Bergeon



Dust Blower - Bergeon Swiss - Bakelite

- Bergeon 30540
- Will not roll around on your bench
- Ø35mm

Code	Description	UOM	Price
B0089	Bergeon Bakelite Dust Blower	EACH	£21.95

### Pen (Dust Blower), Bergeon Swiss



Dust Blowing Handpiece - Bergeon Swiss

- Handheld
- Ergonomic design
- To be used with a compressor or attached to an already existing pump network
- Air flow controlled with the push of a button
- Bergeon 6809
- Compressor connector C41895 will connect the pen to our Bambi compressors
- Brush connectors available, see our codes V45930, V45931 & V45932

Code	Description	UOM	Price
B40225	Dust Blower Pen	EACH	£74.95
B40226	Connection tube for Pen to Compressor	2 METRES	£6.15

### Rubber, A\*F Swiss



Dust Blower - A\*F Swiss

- A\*F Swiss
- Sleeved nozzle
- Ø58 x 125mm overall

Code	Description	UOM	Price
B0088	A&F Rubber Dust Blower	EACH	£7.50

### Rubber, Bergeon 4657



Dust Blower - Bergeon Swiss

- Bergeon 4657
- Metal nozzle with plastic protection
- Length 100mm
- Ø58mm

Code	Description	UOM	Price
B0090	Bergeon Rubber Dust Blower Bergeon 4657	EACH	£7.95

PRICE PROMISE GUARANTEE

**Rubber, Bergeon 5733**



Dust Blower - Bergeon Swiss - Pear

- Bergeon 5733
- Pear shape
- Metal nozzle with plastic protection
- Length 100mm
- Ø60mm

Code	Description	UOM	Price
<b>B0091</b>	Bergeon Rubber Dust Blower Bergeon 5733	EACH	<b>£8.75</b>

**Rubber, E.U Made**



Dust Blower - Made in E.U

- Metal nozzle
- Length 130mm
- Ø55mm
- Made in the E.U

Code	Description	UOM	Price
<b>R38208</b>	European Rubber Dust Blower	EACH	<b>£4.75</b>

**Vacuum Pens**

Vacuum Pens - Standard and Mini

Low-cost alternative to tweezers for the pickup and placement of delicate parts

- Pick up metal, plastic, surface mount resistors, or any other item having a smooth - nonporous surface that the rubber vacuum tip can seal against
- Extra soft silicone suction cups won't scratch or damage sensitive parts

How to use:

1. Install the suction header on suction pencil
2. Place the suction header level on component
3. Press down the button for the standard or press the body for the mini on the suction pencil to let out the air within the vacuum unit, then release the button to produce vacuum suction force to pick up part
4. Place the part on an appropriate place, press down the button/body, the vacuum unit discharges air to let the part fall off the suction header

**Ø12.3 x 155mm Manual Vacuum Pen**



- 1 x Vacuum sucking soft comfortable rubber coated Pen 130mm
  - 1 x Straight probe 30mm
  - 1 x Bent probe 30mm
  - 2 x 3mm suction head
  - 2 x 7 mm Suction Headers
  - 2 x 10 mm Suction Headers
- Weight: 40 grams

Code	Description	UOM	Price
<b>V33907</b>	Ø12.3 x 155mm Manual Vacuum Pen	EACH	<b>£13.95</b>

**Ø13 x 90mm Manual Vacuum Pen**



- 1 x Vacuum sucking soft rubber Pen 75mm
  - 3 x Bent probes suction head 7mm
  - 3 x Straight probes suction head 3mm
- Weight: 55 grams

Code	Description	UOM	Price
<b>V33906</b>	Ø13 x 90mm Manual Vacuum Pen	EACH	<b>£12.95</b>

**Vacuum Pen, Bergeon Swiss**



Vacuum Handpiece - Bergeon Swiss

- Handheld
- Ergonomic design
- To be used with a compressor or attached to an already existing pump network
- Air flow controlled with the push of a button
- Bergeon 8809
- 45° fitting for ease of use
- Compressor connector C41895 will connect the pen to our Bambi compressors
- Compressor connection lead is our reference B40226
- Brush connectors will also fit the Bergeon dust blower pen, our code B0225

• Bergeon 8809-R45

Code	Description	UOM	Price
<b>V45929</b>	Vacuum Pen, Bergeon Swiss	EACH	<b>£64.95</b>
<b>V45930</b>	Very Soft Brush for Vacuum Pen	EACH	<b>£12.50</b>
<b>V45931</b>	Soft Brush for Vacuum Pen	EACH	<b>£12.50</b>
<b>V45932</b>	Coarse Brush for Vacuum Pen	EACH	<b>£12.50</b>

**Vacuum Pump, A\*F Swiss**

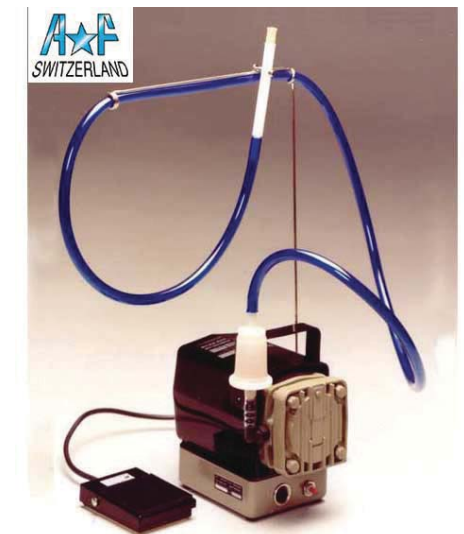

Vacuum Pump Dust Remover - A\*F Swiss

Used by the Top Swiss Watch Houses

- Suction debit: 1.2 cubic metres / hour
- Vacuum up to 150mbar
- Width 100 x Depth 170 x Height 165mm
- Weight: 4.3Kg
- 220 to 240 volt

Click website "More Information" for full specification.

Code	Description	UOM	Price
<b>E19466</b>	Dust Remover Vacuum Pump	EACH	<b>£1,250.00</b>
<b>E20296</b>	Dust Remover Vacuum Pump Spare Brush	EACH	<b>£15.95</b>

**Vacuum Pump, Roxer Swiss**

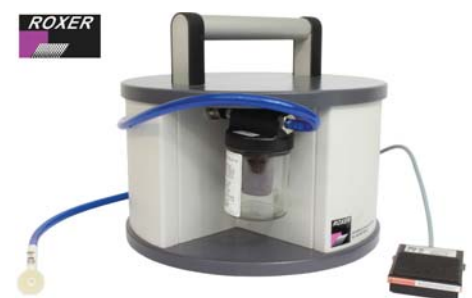

Vacuum Pump Dust Remover - Roxer

An Elite vacuum pump brought to you from Roxer Switzerland. This high class pump is at the top of the range in its field and its quality is evident.

- Available with one or two work stations
- Requires no servicing
- Long life span
- 230V

One complete unit contains:

- 1 Vacuum pump, suction at 4.1m<sup>3</sup> per hour
- 1 inlet filter
- 1 foot switch (E37065)
- 1 vacuum pen (E37070)
- 1 vacuum pen stand (E37071)
- 2 RX14 white bristle brushes (E37067)
- 2 RX15 blue nylon brushes (E37069)
- 3 metres of tubing (E37072)

(Pump for two workstations comes with double the accessories mentioned above, except the pump and inlet filter)



- Dimensions:
- Ø310 x 262mm
  - 13.5Kg

Click website "More Information" & "PDF's" for full specification.

Code	Description	UOM	Price
E37063	Vacuum Pump, 1 Operator	EACH	£1,985.00
E37064	Vacuum Pump, 2 Operators	EACH	£2,150.00
E37066	Accessories Set for Vacuum pump	EACH	£134.50
E37069	Brushes, Blue Nylon	PACK*2	£17.45
E37067	Brushes, White Bristle	PACK*2	£17.45
E37065	Foot Switch for Vacuum Pump	EACH	£149.95
E37072	Tubing for Vacum Pump	3 METRES	£9.95
E37070	Vacuum Pen	EACH	£44.95
E37071	Vacuum Pen Stand	EACH	£32.95

- Comes with five acid testing bottles complete with application paddle
- Gold testing touchstone included
- Compartments Ø23mm

Size: 115 x 90 x 70mm  
Weight: 450g

Code	Description	UOM	Price
T36077	5 Compartment (4 Acid Bottles & Touchstone)	EACH	£14.50

## 5 Compartment (Various)

Put your acid testing bottles and touch stone in this unit for safe storage and transportation.



- Easy open and close magnetic lid
- Dimensions: 95 x 70 x 100mm

Compartments:

- 27 x 27mm (8 compartments)
- 42 x 21mm (1 compartment)

Code	Description	UOM	Price
B22159	5 Compartment (Various)	EACH	£5.95

## 9 Compartment (Various)

Put your acid testing bottles and touch stone in this unit for safe storage and transportation.



- Easy open and close magnetic lid
- Dimensions: 195 x 90 x 100mm

Compartments:

- 33 x 33mm (8 compartments)
- 70 x 33mm (1 compartment)

Code	Description	UOM	Price
S39268	9 Compartment (Various)	EACH	£8.95

## TOOL BOXES, RACKS & STANDS

### 36 Hole Burr Box



- Size: 125 x 75 x 60mm
- Lacquered light wood
- Hinge lid with catch

- Holds burs with Ø2.35mm shank

Code	Description	UOM	Price
B9470	Burr Box, 36 Hole	EACH	£6.95

### 36 Hole Burr Stand

- 3 Tier
- Height 65mm
- Diameter 55mm
- Plastic
- Lid
- Holds burs with Ø2.35mm shank



Code	Description	UOM	Price
B8681	Burr Stand 36 Holes, 3 Tier	EACH	£2.20

### 40 Hole Burr Stand

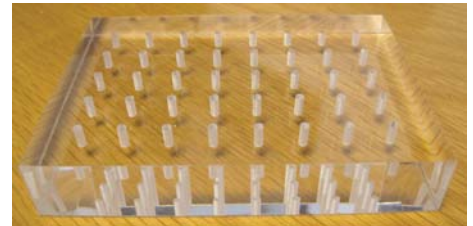

- Size: 110 x 75 x 20mm
- Clear acrylic material
- Capable of holding 40 burs
- Holds burs with Ø2.35mm shank

Code	Description	UOM	Price
B42905	40 Hole Acrylic Burr Stand	EACH	£6.95

### 88 Hole Burr Stand



Multi purpose for burs, drills, mini mops, buffs & brushes. Keep your bench tidy and tools easy to find and access.

- Size: 155 x 95 x 45mm (25mm lowest point)
- Weight: 300g

Code	Description	UOM	Price
S34936	Wooden Burr Stand, 88 Hole	EACH	£5.95

### Benches & Bench Accessories

See Page 648



### Mandrels

See Page 1138



## BOXES, CONTAINERS, JUGS, FUNNELS, STANDS AND TRAYS

## ACID BOTTLE WOODEN BOXES

### 2 Compartment (2 Acid Bottles Ø35mm)

- Holds 2 gold testing acid bottles
- Hole diameter Ø35mm
- 100 x 45 x 30mm



Code	Description	UOM	Price
S39267	2 Compartment (2 Acid Bottles Ø35mm)	EACH	£1.95

### 4 Compartment (3 Acid Bottles & Touchstone)

- Fill your acid testing solutions in this unit for safe storage and transportation
- Easy open and close magnetic lid
- Comes with three acid testing bottles complete with application paddle
- Gold testing touchstone included
- Compartments Ø23mm



Size: 110 x 65 x 70mm  
Weight: 300g

Code	Description	UOM	Price
T36078	4 Compartment (3 Acid Bottles & Touchstone)	EACH	£12.50

### 5 Compartment (4 Acid Bottles & Touchstone)

- Fill your acid testing solutions in this unit for safe storage and transportation
- Easy open and close magnetic lid



### 100 Hole Burr Box



- Size: 145 x 145 x 60mm
- Lacquered light, hard wood
- Hinge lid with magnet catch
- Holds burrs with Ø2.35mm shank

Code	Description	UOM	Price
B9469	Burr Box, 100 Hole	EACH	£11.85

### 200 Hole Burr Box



- Size: 250 x 150 x 60mm
- Lacquered hard wood box
- Hinge lid with magnet catch
- Holds burrs with Ø2.35mm shank

Code	Description	UOM	Price
B41171	Burr Box, 200 Hole	EACH	£15.95

### Magnetic Revolving Burr Stand

- Can hold up to 40 burrs
- Height: 50mm
- Diameter: 60mm



Code	Description	UOM	Price
S34937	Magnetic Burr Rotary Stand	EACH	£4.95

### Multi-Positional Burr Stand, A\*F Swiss

A\*F Swiss

Small stand in plastic, ideal for holding and preventing loss or damage to burrs, drills, midjet brushes etc. Keeps tools within easy reach of the jeweller.

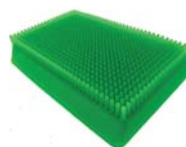

- Multi-positional synthetic base
- Spiked to hold shanks
- Size: 130 x 80 x 25mm

Code	Description	UOM	Price
S4269	Multi Burr Stand	EACH	£10.95

### Multi-Positional Burr Stand, Indian

Made in Indian

Small stand in plastic, ideal for holding and preventing loss or damage to burrs, drills, midjet brushes etc. Keeps tools within easy reach of the jeweller.

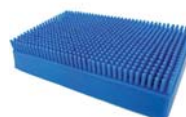

- Multi-positional synthetic base
- Spiked to hold shanks
- Size: 120 x 70 x 25mm

Code	Description	UOM	Price
S35086	Multi Burr Stand	EACH	£3.95

### Revolving Burr Stand, Foredom

Rotating stand with quality steel ball bearings. Ideal for for burrs & drills with a centre space for tools.

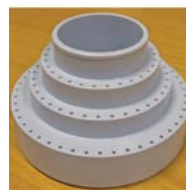

- 3 Tier
- Holds 114 burrs
- Ø170 x 105mm (diameter at base x height)
- Ø70mm x 75mm deep internal centre to hold tools
- Foredom FD10081
- Made in USA

Code	Description	UOM	Price
FD10081	Burr Stand, Made in USA	EACH	£12.95

### Revolving Burr Stand, Indian

Rotating stand with quality steel ball bearings. Ideal for for burrs & drills with a centre space for tools.



- 3 Tier
- Holds 114 burrs
- Ø170 x 105mm (diameter at base x height)
- Ø70mm x 70mm deep internal centre to hold tools
- Made in India

Code	Description	UOM	Price
B19400	Burr Stand, Revolving, 3 Tier	EACH	£9.95

### Burr Cleaning "Pen Type" Brush

See Page 797



### Repair Job Envelope Stand



Repair Job Envelope Stand

Organise your repair job envelopes with this simple and efficient stand. Made from sturdy clear plastic, it has 3 removable divisions, allowing you to create up to 4 compartments or just the size space you need.

- Clear plastic
- 3 removable separations
- 280 x 90 x 90mm (Height x width x depth)

Code	Description	UOM	Price
S39271	Repair Job Envelope Stand	EACH	£7.95

### Saw (Piercing) Blade Stand

- Keeps your piercing saw blades organised and easy to access
- With markings for easy identification
- Swivel base
- Wooden
- Ø95mm base
- Overall height 120mm



Code	Description	UOM	Price
S47022	Saw Blade Stand, Piercing	EACH	£8.95

### Tool Box Padlock

- Perfect for fitting with our tool box range
- 32mm
- Hardened Steel shackle
- Self locking action
- Brass body
- Supplied with 3 keys



### Catches & Clasps

See Page 13



### Burrs or Fraises - All Types

See Page 806



Code	Description	UOM	Price
P33526	32mm Brass Padlock	EACH	£3.60

**Tool Box Tidy**



- For storing pliers, files, tweezers and hand tools
- Lacquered wood
- With draw
- Size: 190 x 165 x 100mm

Code	Description	UOM	Price
B9477	Tool Box Tidy	EACH	£12.95

**Tool Box with Tray**



Very convenient for storing or transporting tools when travelling to a customers premises etc.

Whitefurze or Stanley Toolboxes

Whitefurze;

- Light weight sturdy design
- Top cover compartment see through lid 4 separate handy compartments
- Convenient middle removable inner tray for in main tool box
- Hinged up / down carry handle
- Build in pad lock tab for extra security (pad lock not included)
- Cobalt Blue
- Made in UK

Stanley:

- Robust metal latches
- Soft grip handle that folds flat into box
- Top cover compartment with 2 separate handy compartments
- Removable tray inside
- Built in padlock eye
- Made in UK

Code	Description	UOM	Price
B8692	32cm Tool Box, Whitefurze (popular with students)	EACH	£6.95
T46050	41cm Tool Box, Stanley	EACH	£10.50
T46051	51cm Tool Box, Stanley	EACH	£11.95
T46052	65cm Tool Box, Stanley	EACH	£18.95

**Tool Case (Pliers & Cutters)**



Plier Case - Leather

- Leather plier case
- Holds 4 pliers
- Zip locked
- Great for transportation and storage
- 160 x 170mm

Code	Description	UOM	Price
P39499	Leather Case for Pliers	EACH	£4.95

**Tool Rack Organiser**



- Wooden tool rack organiser
- Sits on your workbench
- Exactly what you need to organise your workbench/ workshop
- Draws, racks, hanging stations, open storage bins and burr holes
- 460 x 115 x 185mm (width x depth x height)

Features

- 4 draws
- 6 rack slots (top left)
- 48 holes for burrs & drills
- 2 racks for pliers & cutters
- 3 open spaces

Code	Description	UOM	Price
T45704	Tool Organiser	EACH	£29.95

**Tool Rack Tidy**



- Plier rack
- Burr stand
- File stand
- Sturdy yet lightweight acrylic
- 560g

Code	Description	UOM	Price
P41188	Tool Rack Tidy	EACH	£19.95

**Tool Rack, Plastic (Pliers & Cutters)**

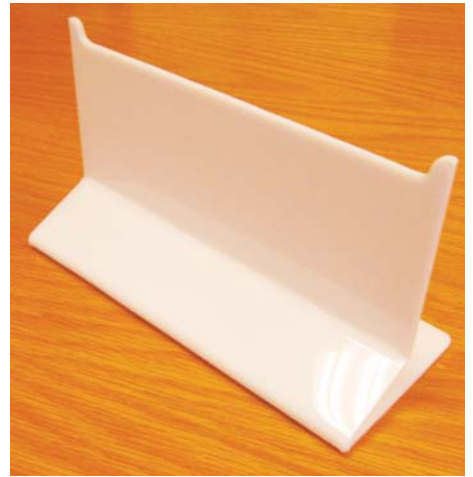

Plier Rack - Plastic

- Very handy for organizing pliers on work bench
- Holds up to 12 pliers
- White Plastic
- Length 230mm
- Width 100mm
- Height 130mm

Code	Description	UOM	Price
P19162	Plastic Plier Rack	EACH	£5.50

**Tool Rack, Plastic & Steel (Pliers & Cutters)**



Plier Rack - Plastic & Steel

- Very handy for organizing pliers on work bench
- Plastic ends with steel rack
- 3 Point structure, hard to knock over
- New age, modern look

Dimensions:

- Length 200mm
- Width 85mm
- Height 100mm

Code	Description	UOM	Price
P37129	Plier Rack	EACH	£7.95

**Drill Bits - HSS**

See Page 836



**Files**

See Page 869



**Tool Rack, Wooden (Pliers & Cutters)**



Plier Rack - Wooden

- Very handy for organizing pliers on work bench
- Holds up to 10 pliers
- Smooth wood
- Length 185mm
- Width 90mm
- Height 125mm

Code	Description	UOM	Price
P39501	Wooden Plier Rack	EACH	£5.95

**Tool Stand, Wooden (Pliers & Cutters)**



Plier Stand - Wooden Base

- Hard wood varnished
- Keeps your work bench tidy
- Stores 6 or 3 pairs of pliers upright

P39500:

- 75 x 95 x 25mm
- Holes are 12mm apart
- Hole diameter Ø14mm

P7985:

- 75 x 160 x 25mm
- Holes are 33.50mm apart
- Hole diameter Ø14mm

Code	Description	UOM	Price
P39500	3 Pliers Stand	EACH	£2.50
P7985	6 Pliers Stand	EACH	£3.65

**Tool Rack (Wall Mounted)**



Wooden jewellery tool storage rack

This superb rack is a fantastic way to store your workshop tools. The ability to mount this item to the wall can not only save space in a busy workshop, but allows quick and easy access to all your tools.

- Simply secure on to your wall (screws and wall plugs not provided)
- Store up to ten hammers (depending on the size of the head)
- Space for up to nine average size triblets/ring sticks, stopping them from rolling loosely around your work area
- Located on the left hand side are two magnetic tool strips, ideal to attach your pliers, tweezers etc.
- Traditional dark brown finish

Dimensions: 460 x 170 x 165mm

- Wood thickness: 18mm (approx.)
- Ring stick holes: Ø21mm
- Magnetic tool holder strips: 160 & 140mm
- Weight: 1.8Kg

Code	Description	UOM	Price
S36086	Wall Mounted Tool Rack	EACH	£19.50

**COMPARTMENT BOXES, POTS & TUBES**

*We have a great variety of storage and transportation boxes, catering to all your horological, jewellery and gemmology needs. From professional gemstone display cases to sturdy gold testing acid bottle storage, as well as safe and secure small parts compartment storage, you really don't need to look anywhere else!*

*The sizes displayed are only the overall sizes, many of our boxes are compartmentalised, either containing many small removable compartments, or have fixed or removable dividers. Drop down the headings to see our full range of products.*

**Aluminium Pots in Aluminium Box**



- Multiple, removable compartments
- Inserts have removable, glass lids
- Aluminium inserts
- In aluminium case
- With foam in lid for noise reduction

Dimensions - overall size, (Insert size):

- B39609: 165 x 135 x 20mm, (Ø40 x 20mm)
- B39607: 165 x 135 x 20mm, (Ø30 x 17mm)
- B39608: 165 x 135 x 20mm, (Ø25 x 18mm)
- B39610: 165 x 110 x 20mm, (Ø15 x 20mm)

Code	Description	UOM	Price
B39609	12 Round Compartments, 165 x 135 x 20mm	EACH	£4.50
B39607	24 Round Compartments, 165 x 135 x 20mm	EACH	£4.50
B39608	20 Round Compartments, 165 x 135 x 20mm	EACH	£4.95
B39610	54 Round Compartments, 160 x 110 x 20mm	EACH	£8.75

**Aluminium Pots in Cardboard Box**



Handy storage containers to keep watch/pocket watch movements or jewellery casting wax models safe

- Aluminium with see through glass lids
- Supplied in cardboard box
- Pack\*12, pack\*6 (B39611) or pack\*24 (B39616)

Dimensions:

- Individual container diameter x height

Code	Description	UOM	Price
B39616	Ø20mm x 20mm Aluminium Tins	PACK*24	£3.95
B39615	Ø30mm x 15mm Aluminium Tins	PACK*12	£2.95
B39614	Ø35mm x 20mm Aluminium Tins	PACK*12	£2.95
B39613	Ø45mm x 20mm Aluminium Tins	PACK*12	£3.95
B39612	Ø55mm x 25mm Aluminium Tins	PACK*12	£3.95
B39611	Ø75mm x 25mm Aluminium Tins	PACK*6	£4.95



**Hand Held Micro Torch**



See Page 656

**Marking & Scoring**



See Page 921

**Display Turntables**

See Page 658



**Aluminium Pots in Wooden Box**



- Multiple, removable compartments
- Aluminium tubs
- Classy wooden storage & transportation box
- Inserts have removable, glass lids
- Magnetic lid
- See additional information for full specification

Code	Description	UOM	Price
B42961	18 Round Compartments, Multi Size	EACH	£10.50
B39619	18 x Ø45mm Round Compartments	EACH	£12.95
B39618	24 x Ø22mm Round Compartments	EACH	£7.95
B39617	36 x Ø22mm Round Compartments	EACH	£9.95

**Compartment Boxes with Divides**

- For spare parts, beads any small items
  - Removable or hinged lid
  - Plastic
- Dimensions - overall size (compartment size):
- B47257: 130 x 70 x 20mm (25 x 30 x 20mm)
  - B5593: 67 x 51 x 10mm (10 x 25 x 10mm)
  - B8744: 110 x 65 x 14mm (10 x 30 x 14mm)
  - B9831: 210 x 110 x 30mm (34 x 34 x 30mm)

**10 Compartments, 130 x 70 x 20mm**



- For spare parts
- 10 Sections with hinged lid
- Compartment sizes: 25 x 30 x 20mm
- 130 x 70 x 20mm

Code	Description	UOM	Price
B47257	10 Compartments, 130 x 70 x 20mm	EACH	£1.50

**12 Compartment Storage Box**



- For spare parts
- 12 Sections with lid
- Compartment sizes: 10 x 25 x 10mm
- 67 x 51 x 10mm

Code	Description	UOM	Price
B5593	12 Compartment Storage Box	EACH	£0.95

**18 Compartment Storage Box**



- For spare parts
- Plastic
- 18 Sections with lid
- Compartment sizes: 10 x 30 x 14mm
- 110 x 65 x 14mm

Code	Description	UOM	Price
B8744	18 Compartment Storage Box	EACH	£1.25

**18 Compartment Storage Box**



- Plastic
- With lid
- Compartment sizes: 34 x 34 x 30mm
- 210 x 110 x 30mm

Code	Description	UOM	Price
B9831	18 Compartment Storage Box	EACH	£3.75
Price breaks available, see website			

**Compartment Boxes with Divides, Bergeon**



- Bergeon 2968
- Hinged Lid
- Clear Transparent Plastic
- 6 Different Compartment Configurations
- Outer dimensions: 195 (L) x 90 (W) x 21mm (D)

Code	Description	UOM	Price
B6677	1 Compartment Storage Box	EACH	£18.95
B0135	3 Compartment Storage Box	EACH	£18.95
B6678	6 Compartment Storage Box	EACH	£18.95
B0136	12 Compartment Storage Box	EACH	£18.95
B0137	18 Compartment Storage Box	EACH	£18.95
B0138	36 Compartment Storage Box	EACH	£18.95

**Compartment Boxes with Divides, Round**



- Five compartment trays
- Stackable
- Ideal for movements, dismantled and ready for repair
- Ø75mm

Code	Description	UOM	Price
P7986	5 Compartment Storage Box	EACH	£1.35
Price breaks available, see website			

**Compartment Boxes with Divides, Slide Lid**

- For spare parts, beads any small/medium items
- Completely removable, clear plastic slide lid
- Plastic base

- Dimensions - overall size (compartment size):
- B39605: 190 x 145 x 20mm (Various)
  - B47052: 190 x 100 x 20mm (30 x 30 x 15mm)
  - B39606: 265 x 170 x 45mm (42 x 55 x 36mm)
  - B39604: 195 x 125 x 20mm (30 x 30 x 15mm)
  - B48656: 195 x 125 x 20mm (30 x 30 x 15mm)

**Tie on Tags x1000**

**See Page 1199**



**250g Watch Parts Assortd**  
**See Page 210**

**11 Compartments, 190 x 145 x 20mm**



- Overall size: 190 x 145 x 20mm
- Compartment size: Various
- Black

Code	Description	UOM	Price
<b>B39605</b>	11 Compartments, 190 x 145 x 20mm	EACH	<b>£2.95</b>

**18 Compartments, 190 x 100 x 20mm**



- Overall size: 190 x 100 x 20mm
- Compartment size: 30 x 30 x 15mm
- Black

Code	Description	UOM	Price
<b>B47052</b>	18 Compartments, 190 x 100 x 20mm	EACH	<b>£2.95</b>

**18 Compartments, 265 x 170 x 45mm**



- Overall size: 265 x 170 x 45mm
- Compartment size: 42 x 55 x 36mm
- Blue

Code	Description	UOM	Price
<b>B39606</b>	18 Compartments, 265 x 170 x 45mm	EACH	<b>£5.95</b>

**24 Compartments, 195 x 125 x 20mm**



- Overall size: 195 x 125 x 20mm
- Compartment size: 30 x 30 x 15mm
- Blue

Code	Description	UOM	Price
<b>B39604</b>	24 Compartments, 195 x 125 x 20mm	EACH	<b>£2.95</b>

**18 Compartments, 190 x 100 x 20mm**



- Overall size: 195 x 125 x 20mm
- Compartment size: 30 x 30 x 15mm
- White

Code	Description	UOM	Price
<b>B48656</b>	18 Compartments, 190 x 100 x 20mm	EACH	<b>£2.95</b>

**Compartment Boxes with Divides, XL**

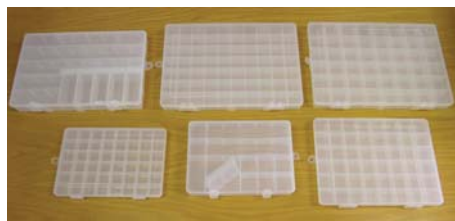

Working away in your in a busy workshop, retail, arts/craft, model making home environment there is nothing like been frustrated finding an item.

Our range of sturdy see through polyethylene compartment boxes provides easy storage of small components.

- Sturdy see-through polyethylene construction
- With click lock lid, integral hinges sealing the compartments to avoid spillage and cross section mixing.
- Our compartment boxes come in two type's fixed or flexible removable dividers and a variety of sizes
- hang your compartment boxes on a wall space with the integrated hanging hook

Code	Description	UOM	Price
<b>B33898</b>	260 x 175 x 30mm, 48 Compartment	EACH	<b>£3.25</b>
<b>B33832</b>	260 x 175 x 50mm with Removeable Dividers	EACH	<b>£4.45</b>
<b>B33897</b>	300 x 220 x 35mm, 48 Compartment	EACH	<b>£6.50</b>
<b>B33833</b>	350 x 230 x 50mm with Removeable Dividers	EACH	<b>£7.95</b>
<b>B33900</b>	375 x 260 x 40mm, 48 Compartment	EACH	<b>£8.75</b>
<b>B33899</b>	375 x 260 x 40mm, 72 Compartment	EACH	<b>£8.75</b>

**Compartment Tray, Revolving**



- Revolving plastic compartment tray
- Transparent lid with one opening so only one compartment is open at a time
- Ensures parts are accessible and visible but will not fall out or mix
- 11 or 22 compartments
- Overall diameter Ø90 or 190mm

Code	Description	UOM	Price
<b>T47054</b>	11 Compartments, Ø90mm	EACH	<b>£1.25</b>
<b>T47055</b>	22 Compartments, Ø190mm	EACH	<b>£2.50</b>

**Plastic Boxes, Extendable**



Plastic extendable boxes, excellent for storing delicate tools & items

- Strong plastic
- Extendable
- Great for files, gravers etc

Dimensions:

- Width x Height (Shortest length x Longest length)

Code	Description	UOM	Price
<b>B47564</b>	10 x 10mm (120 x 205mm) Box	PACK*5	<b>£1.50</b>
<b>B47563</b>	12 x 12mm (75 x 130mm) Box	PACK*5	<b>£1.80</b>
<b>B47565</b>	25 x 25mm (125 x 215mm) Box	PACK*5	<b>£2.95</b>
<b>B47566</b>	25 x 25mm (200 x 365mm) Box	PACK*3	<b>£2.95</b>

**Plastic Pot (Square)**



Sturdy square container to store or send delicate parts, including dials, movements and small castings

- Square
- Plastic
- Strong construction
- Hinged or removable lid

Code	Description	UOM	Price
<b>B47051</b>	41 x 32 x 12mm Box (Removable Lid)	PACK*10	<b>£2.25</b>
<b>B41749</b>	45 x 45 x 13mm Box (Hinged Lid)	PACK*10	<b>£2.00</b>

Price breaks available, see website

**Plastic Pots (Round)**



Sturdy round container to store or send delicate parts, including dials, movements and small castings

- Round
- Screw rim
- Multiple sizes
- Plastic
- Hard plastic

Dimensions:

- Diameter x Overall height

Code	Description	UOM	Price
<b>B47253</b>	Ø30 x 15mm Pot	EACH	<b>£0.25</b>
<b>B47254</b>	Ø38 x 20mm Pot	EACH	<b>£0.35</b>
<b>B47255</b>	Ø50 x 20mm Pot	EACH	<b>£0.60</b>
<b>B47256</b>	Ø70 x 35mm Pot	EACH	<b>£0.75</b>

Price breaks available, see website

**Watch Case Back Screws**  
See Page 258

**Plastic Pots in Box**



- Multiple, removable compartments
- Inserts have thread action lids
- High quality
- Plastic
- See through for maximum visibility

Dimensions- overall size, (Insert size):

- B35514: 125 x 95 x 20mm, (Ø30 x 15mm)
- B35515: 160 x 120 x 25mm, (Ø38 x 20mm)
- B47053: 160 x 135 x 25mm (Ø30 x 19mm) (non thread action lids)

Code	Description	UOM	Price
B35514	12 Round Compartments, 125 x 95 x 20mm	EACH	£6.95
B35515	12 Round Compartments, 160 x 120 x 25mm	EACH	£7.50
B47053	20 Round Compartments, 160 x 135 x 25mm	EACH	£2.95

**Plastic Pots in Box**



- Multiple, removable compartments
- Plastic
- Compartments have clear lids

Dimensions - overall size, (Insert size):

- B32995: 165 x 140 x 25mm, (60 x 50 x 15mm)
- B32394: 165 x 140 x 25mm, (Ø30 x 17mm)

Code	Description	UOM	Price
B32995	6 Rectangular Boxes, 165 x 140 x 25mm	EACH	£2.45
B32394	20 Round Compartments, 165 x 140 x 25mm	EACH	£2.95

**Plastic Pots in Box, Swiss Made**



- Plastic pots in box
- For spare parts
- 260 x 105 x 24mm
- Bergeon Swiss or Swiss made

Comprising:

- 21 x Ø21mm Round Boxes
- 2 x Ø40mm Round Boxes

Code	Description	UOM	Price
B0134	23 Round Compartment Storage Box, Bergeon 6088D	EACH	£23.50

B41943	23 Round Compartment Storage Box, Swiss Made	EACH	£17.95
--------	--	------	--------

**Membrane Boxes**

These patented boxes are transparent and allow the arrangement, packing and shipment of fragile items, of every shape, for the jewellery, horological & electronic industries etc.

- Elastic membrane boxes
- Individual size: 39 x 39 x 17.8mm
- Supplied individually, pack\*6, pack\*12 or a pack\*100
- The items are suspended between the membranes of the box and the cover.

**Membrane Box, Individual, Non Swiss**



- Elastic Membrane Box
- Indian
- 39 x39 x17.8mm

Code	Description	UOM	Price
B5592	Membrane Box, Individual, Non Swiss	PACK*100	£29.95

**Membrane Box, Individual, Bergeon 6799.01**



- High Quality
- Elastic Membrane Box
- Bergeon 6799.01
- 39 x39 x17.8mm

Code	Description	UOM	Price
B32287	Membrane Box, Individual, Bergeon 6799.01	EACH	£2.45

**Membrane Box, Set of 6, Bergeon 6799.06**



- High Quality
- Elastic Membrane Box
- Bergeon 6799.06
- 120 x 79 x 17.8mm

Code	Description	UOM	Price
B32288	Membrane Box, Set of 6, Bergeon 6799.06	PACK*6	£14.50

**Membrane Box, Set of 12, Bergeon 6799.12**



- High Quality
- Elastic Membrane Box
- Bergeon 6799.12
- 240 x 79 x 17.8mm

Code	Description	UOM	Price
B32289	Membrane Box, Set of 12, Bergeon 6799.12	PACK*12	£22.95

**Tubes & Watch Part Containers**

- Excellent for storing fine parts, crowns, watch hands, stems, gemstones etc
- Use the tubes in conjunction with B8744 to truly keep your parts organised and accessible

**Box for Watch Parts**



- External Diameter Ø17mm
- 50 pieces

Code	Description	UOM	Price
B31092	Box for Watch Parts	PACK*50	£4.25



**Tubes for Watch Parts, Cylinder**



External: 8 x 27mm (Including Lid)  
Internal: 6mm  
(Red Lid)  
100 pieces

Code	Description	UOM	Price
T31091	Tubes for Watch Parts, Cylinder	PACK*100	£4.95

**Tubes for Watch Parts, Rectangle**



- External: 7.5 x 7.5 x 23mm
- Internal: 5 x 5 x 19mm
- Lid colour may vary
- 100 pieces each lids & tubes

Code	Description	UOM	Price
T47707	Tubes for Watch Parts, Rectangle	PACK*100	£6.95

**Tubes for Watch Parts, Rectangle, Horotec Swiss**



- External: 9 x 9 x 23mm
- Internal: 6 x 6 x 19mm
- Lid colour may vary
- 100 pieces each lids & tubes

Code	Description	UOM	Price
T1723	Tubes for Watch Parts, Rectangle, Horotec Swiss	PACK*100	£12.95

• 250 x 120 x 370mm (L x W x H)

Code	Description	UOM	Price
T28776	Acrylic Glass Thimbles Machine	EACH	£79.95

**DISPLAY & TRANSPORT BOXES & PRESENTATION TRAYS**

**Gemstone Display & Protection Boxes**



Used by gemstone dealers, jewellers, watch and clock part makers/repairs, electronic components industry and collectors.

- Light weight plastic
- Glass top for crystal clear viewing
- Soft foam padding inside
- Padding is reversible, can be either black or white
- The special padding is accurately cut to ensure rattle reduction of gem stones and components
- The glass lens is very useful for viewing items without opening the protection box for display, excellent for display and protection purposes
- A range of compact sizes available for easy transportation (please see below)

Sizes available (External) height x width x depth:

- 25 x 25 x 20mm
- 40 x 40 x 20mm
- 50 x 50 x 20mm
- 100 x 75 x 25mm

Code	Description	UOM	Price
B31448	25 x 25mm White Box	EACH	£0.80
B31452	25 x 25mm Black Box	EACH	£0.80
B31449	40 x 40mm White Box	EACH	£0.95
B31453	40 x 40mm Black Box	EACH	£0.95
B31450	50 x 50mm White Box	EACH	£1.35
B31454	50 x 50mm Black Box	EACH	£1.35
B31451	100 x 75mm White Box	EACH	£2.65
B31455	100 x 75mm Black Box	EACH	£2.65

Price breaks available, see website

**Gemstone Display & Protection Boxes in Cases**

Used by gemstone dealers & jewellers, watch and clock part makers/repairs, electronic components industry and collectors.

- Clear viewing
- Soft white foam padding inside
- The special padding is accurately cut to ensure rattle reduction of gem stones and components
- The glass lens is very useful for viewing items without opening the protection box for display, excellent for display and protection purposes

**Case with 24 Boxes (Ø30mm)**



- Contains 24 removable thread action, round, plastic chrome style finish gem boxes with glass window
- Diameter of window Ø20mm
- Lockable catch lid
- Stylish chrome and black dotted finish
- Suede finish compartment holders and top lid giving you the professional look

Overall size: 230 x 165 x 30mm  
Individual gemstone box size: Ø30 x 15mm  
Weight: 550g

Code	Description	UOM	Price
C36091	Case with 24 Boxes (Ø30mm)	EACH	£22.95

**Case with 25 Boxes (25 x 25mm)**



- Gemstone Leather Box with Clear Glass Top.
- Holds 25 square smaller white gem boxes of size 1" x 1" (Included)
- 185 x 185mm overall size
- Weight 500g

Code	Description	UOM	Price
G31314	Case with 25 Boxes (25 x 25mm)	EACH	£15.95

**Case with 25 Boxes (25 x 25mm)**



- Gemstone Leather Box with Clear Glass Top
- Holds 25 square smaller black gem boxes of size 1" x 1" (Included)
- 185 x 185mm overall size

**DISPENSERS**

**Dispenser, Bergeon Swiss**

Dispenser - Bergeon Swiss

- Great for storing and dispensing finger cots, tags & labels or any small items
- Provides easy access & storage for regularly used items
- Solid, transparent acrylic
- Hinged access lid
- Can be filled from the top
- Two or more can be screwed together
- Bergeon 7872





- Weight 500g

Code	Description	UOM	Price
G43013	Case with 25 Boxes (25 x 25mm)	EACH	£17.65

**Tray with 16 Boxes (45 x 60mm)**



- 16 clear plastic removable boxes (45 x 60mm)
- Faux leather case with felt insert
- Without lid for ease of access & better visual display
- 300 x 230mm overall size

Code	Description	UOM	Price
G47698	Tray with 16 Boxes (45 x 60mm)	EACH	£17.95

**Tray with 24 Boxes (35 x 35mm)**



- Contains 24 removable boxes
- Removable boxes size 35 x 35mm
- Faux leather case with felt insert
- Without lid for ease of access & better visual display
- 300 x 230mm overall size

Code	Description	UOM	Price
B46148	Tray with 24 Boxes (35 x 35mm)	EACH	£15.95

**Tray with 24 Boxes (45 x 45mm)**



- 24 clear plastic removable boxes (35 x 35mm)
- Faux leather case with felt insert
- Without lid for ease of access & better visual display
- 300 x 230mm overall size

Code	Description	UOM	Price
G47699	Tray with 24 Boxes (45 x 45mm)	EACH	£17.95

**Tray with 35 Boxes (25 x 25mm)**



- Contains 35 removable boxes
- Removable boxes size 25 x 25mm

- Faux leather case with felt insert
- Without lid for ease of access & better visual display
- 300 x 230mm overall size

Code	Description	UOM	Price
B46147	Tray with 35 Boxes (25 x 25mm)	EACH	£15.95

**Gemstone Storage & Transportation Boxes**

**Box 5 Groove (Diamond Testing & Transportation)**

Used to examine diamonds. The white background enables you to spot with a loupe flaws easier.



Ideal for short term transportation and storage.

- Dimensions: Width 64mm x Depth 40mm x Height 25mm

Code	Description	UOM	Price
T31263	Box 5 Groove (Diamond Testing & Transportation)	EACH	£2.95

**Box 10 Groove (Diamond Testing & Transportation)**

Used to examine diamonds. The white background enables you to spot with a loupe flaws easier.



Ideal for short term transportation and storage.

- Dimensions: Width 64mm x Depth 40mm x Height 25mm

Code	Description	UOM	Price
T31264	Box 10 Groove (Diamond Testing & Transportation)	EACH	£3.20

**Display Stand for Gemstones**

Ideal for retailers to show their loose stones.

- 4 prong
- Heavy Metal Base
- Weight 10gm
- Height 85mm
- Base Ø22mm



Code	Description	UOM	Price
G31315	Display Stand for Gemstones	EACH	£2.35

**Diamond Wrapping Papers**

See Page 1187



**Display Holder for Gemstones, Gold Colour**

The essential and most effortless crutch for selling diamonds!!



It has a spring loaded shank to flexibly open and close the claws to hold variously sized stones.

After the customer has chosen a gemstone, place the gemstone into the holder and place on the customer's finger, giving the customer the optimum idea of how their ring will look. Essential in any jewellers, this Gem Stone Holder gives you and your sales assistants an impressive and incomparable selling edge.

Why not display all gemstones to encourage impulsive purchases using this tool?

Code	Description	UOM	Price
S12165	Display Holder for Gemstones, Gold Colour	EACH	£1.35

**Display Holder for Gemstones, Silver Colour**

The essential and most effortless crutch for selling diamonds!!



It has a spring loaded shank to flexibly open and close the claws to hold variously sized stones.

After the customer has chosen a gemstone, place the gemstone into the holder and place on the customer's finger, giving the customer the optimum idea of how their ring will look. Essential in any jewellers, this Gem Stone Holder gives you and your sales assistants an impressive and incomparable selling edge.

Why not display all gemstones to encourage impulsive purchases using this tool?

Code	Description	UOM	Price
S12164	Display Holder for Gemstones, Silver Colour	EACH	£1.35

**Holder for 20 Gemstones, Plastic**



Very useful to put inside parcel papers to avoid stones from falling out.

Code	Description	UOM	Price
S31304	Holder for 20 Gemstones, Plastic	EACH	£0.75

**Glass Paste Stones**

See Page 53



### Holder for 55 Gemstones, Plastic

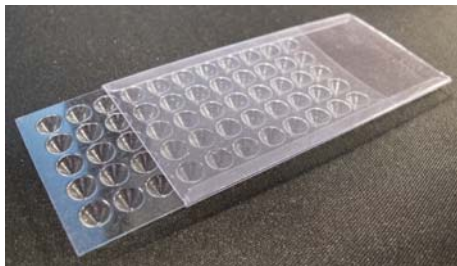

Code	Description	UOM	Price
S31305	Holder for 55 Gemstones, Plastic	EACH	£0.75

### Holder for 72 Gemstones, Plastic



Very useful to put inside parcel papers to avoid stones from falling out.

For small diamonds 0.15ct

Code	Description	UOM	Price
S31306	Holder for 72 Gemstones, Plastic	EACH	£0.95

### Gemstone Storage & Transportation Pouch



- Traditional gemstone pouch
- Leatherette
- Close with a drawstring
- 105 x 75mm (height x width)
- Black or brown

Code	Description	UOM	Price
P42902	Black Pouch for Precious Stones	EACH	£0.95
P44207	Brown Pouch for Precious Stones	EACH	£0.95

### Presentation or Displaying Tray



- Bergeon 2962
- Swiss
- Perfect Finish
- Velvet Covered
- Size: 320 x 220 x 14mm

Velvet covered, perfect finish presentation tray for the most prestigious of retail environments.

Code	Description	UOM	Price
T32992	Displaying Tray / Showing Plate	EACH	£23.95

### Watch Display Cases

Watch Display Cases

- Excellent for window or counter displays
- 5 different colours
- Transparent lid
- Plastic base and lid
- Great value
- Base 45 x 80mm
- Height 85mm

### Maroon Watch Display



Code	Description	UOM	Price
B47570	Maroon Watch Display	EACH	£0.95

### Red Watch Display



Code	Description	UOM	Price
B47567	Red Watch Display	EACH	£0.95

Price breaks available, see website

### Watch Display & Storage Case



Watch Display & Storage Cases

- Single watch display or storage case
- Flat, stackable cases
- Rectangular so fit easily in draws or cabinets
- Excellent for window or counter displays
- Transparent lid
- Plastic base and lid
- Great value
- 115 x 45mm

Code	Description	UOM	Price
B47700	Watch Display & Storage Case	EACH	£0.75

Price breaks available, see website

## DISPLAY DOMES & STANDS

### Display Dome

Display Dome & Base

Ideal for displaying watches & collectibles etc. under an acrylic dome and synthetic base.

- Clear acrylic
- Dark textured synthetic base
- Weighted base for extra stability
- Rigid internal metal hook (colour may vary between gilt and chrome)
- Popular Model



Dimensions: Ø75mm x Height 100mm

Code	Description	UOM	Price
D0428	Ø75mm x 100mm Dome & Base	EACH	£6.25

Price breaks available, see website

### Pocket Watch Display Holders



- Brass
- Opening to Ø55mm

**TODAY** SAME DAY DISPATCH

• Weight 200g

Code	Description	UOM	Price
C31301	1 Arm Brass Case Holder	EACH	£13.65
C31302	2 Arm Brass Case Holder	EACH	£13.65

**Pocket Watch Stands**

Pocket Watch Stands

Let your pocket-watch take pride of place on display in your shop window, on your desk, or even on your mantle piece

- Gold plated & chrome
- Multiple designs
- Free standing

**Half Arch, Chrome**

- Half arch
- Chrome
- 120mm height
- Ø55mm base
- 50mm arm



Code	Description	UOM	Price
P39716	Half Arch, Chrome	EACH	£9.95

**Half Arch, GP**

- Half arch
- Gold plated
- 120mm height
- Ø55mm base
- 50mm arm



Code	Description	UOM	Price
P39717	Half Arch, GP	EACH	£10.95

**Full Arch, Chrome**

- Chrome
- 140 x 100 x 25mm (Height x width x depth)



Code	Description	UOM	Price
P39718	Full Arch, Chrome	EACH	£13.50

**Full Arch, GP**

- Full arch
- Gold plated
- 140 x 100 x 25mm (Height x width x depth)



Code	Description	UOM	Price
P39719	Full Arch, GP	EACH	£13.50

**Straight Arm, Chrome**

- Straight arm
- Chrome
- 95mm height
- Ø55mm base
- 30mm arm



Code	Description	UOM	Price
P39720	Straight Arm, Chrome	EACH	£8.50

**Straight Arm, GP**

- Straight arm
- Gold plated
- 95mm height
- Ø55mm base
- 30mm arm



Code	Description	UOM	Price
P39721	Straight Arm, GP	EACH	£8.50

**DUST COVERS & TRAYS**

*There is nothing more frustrating in your busy workshop than not being organised enough to store and access your parts, components or apparatus. Many a watchmaker, repairer or jeweller have lost or misplaced vital parts, proving costly in both time and monetary value to replace if forever lost.*

*Take a look at our comprehensive range of small parts storage solutions which have the capability to save you a lot of time and money in your workshop. Available we have storage compartment containers with lids, in sections, different colours and even stackable trays.*

**Dust Cover on Divider Tray**

- Ø100mm base
- Plastic cover with knob
- Plastic partitioned tray
- Spare tray or cover available separately
- Bergeon Swiss or unbranded

**Dust Cover, Bergeon Swiss**



- Bergeon 30097C
- Fits Ø100mm base
- Plastic cover with knob

Code	Description	UOM	Price
D0457	Dust Cover, Bergeon Swiss	EACH	£10.25

**Dust Cover with Tray**



- Ø100mm
- Plastic cover with knob
- Plastic partitioned tray

Code	Description	UOM	Price
D6114	Dust Cover with Tray	EACH	£2.30

**Dust Cover with Two Trays**



- Ø100mm
- Plastic cover with knob
- 1 x partitioned tray

**ONLINE F.A.Q.**



• 1 x tray with no partitions

Code	Description	UOM	Price
D47500	Dust Cover with Two Trays	EACH	£3.15

**Dust Cover with Tray, Swiss**



- Bergeon 30097BC
- Ø100mm
- Plastic cover with knob
- Plastic partitioned tray

Code	Description	UOM	Price
D4772	Dust Cover with Tray, Swiss	EACH	£13.25

**Multi Tray Extension, Bergeon Swiss**



- Stack multiple dust cover trays with this extension, giving even more storage on a busy work bench
- Make your dust cover capable of holding larger items
- Bergeon 300097-RH

Code	Description	UOM	Price
D45569	Multi Tray Extension, Bergeon Swiss	EACH	£10.50

**PRICE PROMISE  
GUARANTEE** ✓

**Bead Scoop**  
See Page 775

**Tray with Divisions, Bergeon Swiss**



- Bergeon 30097B
- Ø100mm
- Plastic partitioned tray

Code	Description	UOM	Price
T1719	Tray with Divisions, Bergeon Swiss	EACH	£5.85

**Dust Cover on Divider  
Tray, Extra Large**

**Dust Cover with Tray, Extra Large**



- Ø155mm base
- 150mm overall height
- Plastic cover with knob
- Plastic partitioned tray
- Bergeon 30097-XL-BC

Code	Description	UOM	Price
D45747	Dust Cover with Tray, Extra Large	EACH	£29.95

**Trays, Small Rectangular**

Multi-purpose rectangular utility trays which are very handy in a busy workshop or retail environment

- Plastic
- Rectangular
- Black or white
- Great for watch parts or small components
- Dimensions: Length x width x depth

**Case Cushion with  
Dust Cover**  
See Page 1086

**100 x 60 x 15mm, Black**



- 100 x 60 x 15mm
- Black

Code	Description	UOM	Price
T39049	100 x 60 x 15mm, Black	EACH	£0.95

**100 x 60 x 15mm, White**



- 100 x 60 x 15mm
- White

Code	Description	UOM	Price
T39048	100 x 60 x 15mm, White	EACH	£0.95

**150 x 105 x 25mm, White**



- 150 x 105 x 25mm
- White

Code	Description	UOM	Price
T39051	150 x 105 x 25mm, White	EACH	£1.50

**Trays, Small Square**



- Stackable
- Choice of colours
- Choice of sizes
- Bergeon Swiss

Square Size x Depth:  
• 30mm x 9mm - Bergeon 2362  
• 50mm x 10mm - Bergeon 2378

• 70mm x 13mm - Bergeon 2379

Code	Description	UOM	Price
T1715	Beige (50mm x 10mm) Tray	EACH	£9.95
T1716	Beige (70mm x 13mm) Tray	EACH	£10.50
T1715A	Black (50mm x 10mm) Tray	EACH	£9.95
T1716A	Black (70mm x 13mm) Tray	EACH	£10.50
T1714B	Blue (30mm x 9mm) Tray	EACH	£17.95
T1715B	Blue (50mm x 10mm) Tray	EACH	£9.95
T1716B	Blue (70mm x 13mm) Tray	EACH	£10.50
T1714C	Green (30mm x 9mm) Tray	EACH	£17.95
T1715C	Green (50mm x 10mm) Tray	EACH	£9.95
T1716C	Green (70mm x 13mm) Tray	EACH	£10.50
T1715D	Orange (50mm x 10mm) Tray	EACH	£9.95
T1716D	Orange (70mm x 13mm) Tray	EACH	£10.50
T1714E	Red (30mm x 9mm) Tray	EACH	£17.95
T1715E	Red (50mm x 10mm) Tray	EACH	£9.95
T1716E	Red (70mm x 13mm) Tray	EACH	£10.50
T1714F	White (30mm x 9mm) Tray	EACH	£17.95
T1715F	White (50mm x 10mm) Tray	EACH	£9.95
T1716F	White (70mm x 13mm) Tray	EACH	£10.50
T1714G	Yellow (30mm x 9mm) Tray	EACH	£17.95
T1715G	Yellow (50mm x 10mm) Tray	EACH	£9.95
T1716G	Yellow (70mm x 13mm) Tray	EACH	£10.50

## Trays, Small Weighing

Lightweight weighing trays suitable for diamond or precious metal scales.

- Lightweight
- Aluminium
- Black & white
- Handles & spout make it easy to pour, tip or place gold and gemstones
- Pack\*2

Dimensions:

- 130 x 80 x 30mm
- Weight: 12g

## Diamond & Gold Weighing Cups



- Lightweight
- Aluminium
- Black & white
- Handles & spout make it easy to pour, tip or place gold and gemstones
- Pack\*2

Code	Description	UOM	Price
G39602	Diamond & Gold Weighing Cups	PACK*2	£4.95

## Trays, Watch Disassembly / Assembly

Stackable Plastic Compartment Trays with Stackable Lids for Watch Disassembly & Assembly

- Various colours
- 2 Different Compartment Formats
- Overall Size 245 x 115 x 20mm
- Small Compartment Cavities: 49 x 45 x 16mm
- Large Compartment Cavities: 234 x 42 x 16mm
- Lids Sold Separately
- Weight 110g (Trays)
- Weight 90g (Lid)
- Made in Switzerland

## Blue 6 Compartment Tray



Code	Description	UOM	Price
B34425	Blue 6 Compartment Tray	EACH	£2.75

## Blue 10 Compartment Tray



Code	Description	UOM	Price
B34429	Blue 10 Compartment Tray	EACH	£2.95

## Green 6 Compartment Tray



Code	Description	UOM	Price
B34428	Green 6 Compartment Tray	EACH	£2.75

## Green 10 Compartment Tray



Code	Description	UOM	Price
B34432	Green 10 Compartment Tray	EACH	£2.95

## Red 6 Compartment Tray



Code	Description	UOM	Price
B34427	Red 6 Compartment Tray	EACH	£2.75

## Red 10 Compartment Tray



Code	Description	UOM	Price
B34431	Red 10 Compartment Tray	EACH	£2.95

## Yellow 6 Compartment Tray



Code	Description	UOM	Price
B34426	Yellow 6 Compartment Tray	EACH	£2.75

## Trays, Small Triangular

### Triangular Tray, Aluminium



- 90 x 90 x 90mm
- Aluminium
- Great for watch parts or small components

Code	Description	UOM	Price
T39050	Triangular Tray, Aluminium	EACH	£0.95

### Triangular Tray, Plastic



- 90 x 90 x 90mm
- Plastic
- White
- Great for watch parts or small components

Code	Description	UOM	Price
T1718	Triangular Tray, Plastic	EACH	£0.95

Finger Cots -  
Latex

See Page 720



Latex Disposable  
Gloves

See Page 722



**Yellow 10 Compartment Tray**



Code	Description	UOM	Price
B34430	Yellow 10 Compartment Tray	EACH	£2.95

**Transparent Compartment Lid**



Code	Description	UOM	Price
B34433	Transparent Compartment Lid	EACH	£2.25

**Plastic Key (Black) for 1 Lid & 1 Tray**

- To lock one lid to one tray



Code	Description	UOM	Price
T34439	Plastic Key (Black) for 1 Lid & 1 Tray	EACH	£0.95

**Plastic Key (Yellow) 1 Lid & 2 Trays**

- To lock one lid to two trays



Code	Description	UOM	Price
T34440	Plastic Key (Yellow) 1 Lid & 2 Trays	EACH	£0.95

**Plastic Key (Red) 1 Lid & 3 Trays**

- To lock one lid to three trays



Code	Description	UOM	Price
T34441	Plastic Key (Red) 1 Lid & 3 Trays	EACH	£0.95

**Plastic Key (Green) 1 Lid & 4 Trays**

- To lock one lid to four trays



Code	Description	UOM	Price
T34442	Plastic Key (Green) 1 Lid & 4 Trays	EACH	£0.95

**Plastic Key (Blue) 1 Lid & 5 Trays**

- To lock one lid to five trays



Code	Description	UOM	Price
T34443	Plastic Key (Blue) 1 Lid & 5 Trays	EACH	£0.95

**Foam Insert for Small Compartment Cavities**

- For Small Compartment Cavities: 49 x 45 x 16mm



Code	Description	UOM	Price
T34444	Foam Insert for Small Compartment Cavities	PACK*5	£0.80

**Foam Insert for Large Compartment Cavities**



- For Large Compartment Cavities: 234 x 42 x 16mm

Code	Description	UOM	Price
T34445	Foam Insert for Large Compartment Cavities	EACH	£0.55

**FUNNELS, JUGS & LIQUID DISPENSERS**

**Funnels**



Ideal for avoiding spillages when filling and emptying fluids or grains within the workshop

- Ideal for transferring liquid or fine-grained substances
- 3 different diameters available

Code	Description	UOM	Price
F32077	Ø8cm Funnel	EACH	£1.45
F32076	Ø14cm Funnel	EACH	£1.65
F32075	Ø18cm Funnel	EACH	£1.95

**Jugs**



Measuring Jug - Imperial

Ideal for many filling and emptying application within the workshop

- Quality product with easy to read measurements
- Well designed spout for easy pouring
- Suitable for measuring all liquids

Code	Description	UOM	Price
J32080	0.57 Litres (1 Pint) Measuring Jug	EACH	£1.45
J32079	1.14 Litres (2 Pints) Measuring Jug	EACH	£1.85

**Liquid Dispenser**



Liquid Dispenser (popular for soldering flux)

Loss of solutions due to knocking over, evaporation, contamination, etc is an ever present and costly problem when jobbing, this liquid dispenser is ideal for eradicating these issues.

Fill the bottle with the chemical of your choice. The lid flips open to expose a reservoir, press down to dispense a small quantity of the solution. To fill the reservoir completely press it between four and six times, (although this is not necessary), this process restricts solution exposed as well as wastage. Apply the solution using an applicable brush such as a fine flux brush when applying Auflux to solder joints.

- The liquid dispenser holds up to 150ml of solution.
- The reservoir holds up to 15ml of solution.
- Allows the user to work with unpleasant odours confidently making it unnecessary to distribute large amounts of solution in other containers.

Some Chemicals Cousins supplies used in the Liquid Dispenser

- Auflux Soldering Flux Liquid (C4354)
- Hair Spring Degreaser Cleaning Fluid (F2811)
- Aging Chemicals (C20952)
- Lacomit and Lacomit Remover (C4366 & C4369)

Size and Weight:  
110mm x 50mm x 50mm - 80g

Code	Description	UOM	Price
D32989	Liquid Dispenser	EACH	£6.95

**+ Contact & Services** Your direct line to our **Management Team**

**Liquid Dispenser, Fine Tipped**

Excellent for dispensing solder flux for wetting small to large joints with accuracy

Capacity: 100ml



Code	Description	UOM	Price
D34941	Liquid Dispenser, Fine tipped	EACH	£0.99

**LEMEL CONTAINERS**

**Lemel Storage and Sorting Boxes**



A traditional lemle storage and sorting box kit ideal for your jewellers workshop.

- Lemle Storage Cans and Boxes allow you to control small filings, sweeps and pieces of precious metal in individual carats
- Keeping your lemle sweeps will be efficient with this ideal Four jeweller lemle Storage and Storage Boxes
- Simply hand your lemle cups containers to your jewellers when they finished end of the day. Pour your lemle sweep in to Lemle sieve holder shake and find your precious metal sweeps below.

B8346

Kit contains

1 Outer thick gauge steel hammertoe finish case with pad lock facility

All made for light weight in aluminium

2 x Square holding cup trays

4 x Lemle sweep cups

2 x Lemle sieve holders with lid containers

2 x fine hole lemle sieves

B8347

Kit contains

1 Outer thick gauge steel hammertoe finish case with pad lock facility

All made for light weight in aluminium

4 x Square holding cup trays

8 x Lemle sweep cups

4 x Lemle sieve holders with lid containers

4 x Fine hole lemle sieves

Code	Description	UOM	Price
B8346	Small Lemle Storage and Sorting Box	EACH	£79.95
B8347	Large Lemle Storage and Sorting Box	EACH	£139.95

**STORAGE CABINETS (MULTI DRAWER)**

**Storage Cabinets (Multi Drawer)**

Why buy Raaco?

Raaco has developed and manufactured a unique range of quality storage systems for small items, tools and accessories since 1957. The whole range is based on the same basic values: quality, versatility, functionality and environmental awareness.

All the components in Raaco's storage systems are designed to work together and to save time, space and money. The systems almost unlimited versatility means that it offers an efficient solution for every need. Raaco has long been an international market leader in the development and production of storage systems to the highest professional standards.

Raaco - Enamelled Steel Body & Polypropylene Drawers

Robust steel cabinets with a choice of different drawer combinations manufactured in impact proof plastic.

Can stand alone or be wall mounted

**30 Draw Steel Cabinet**



Dimensions:

- Height 375mm
- Width 306mm
- Depth 147mm

Raaco 30 drawers steel cabinet with drawers

- Robust steel cabinet with 30 drawers of impact proof plastic
- Can stand alone or be hung on a wall

Drawers comprise of:

- 25 small size 135mm x 50mm x 35mm
- 3 medium size 135mm x 85mm x 55mm
- 2 large 135mm x 135mm x 55mm

Weight: 2.5kg

Code	Description	UOM	Price
C47818	30 Draw Steel Cabinet	EACH	£19.95

**PRICE PROMISE GUARANTEE**

**44 Drawer Steel Cabinet**



Dimensions:

- Height 510mm
- Width 306mm
- Depth 147mm

Raaco 44 drawers Steel cabinet

- Robust steel cabinet with 44 drawers of impact proof plastic.
- Can stand alone or be hung on a wall.

Drawers comprise of:

- 40 small size 150mm x 65mm x 35mm
- 3 medium size 150mm x 85mm x 60mm
- 1 extra large 300mm x 135mm x 60mm

Weight: 3 kg

Code	Description	UOM	Price
C33830	44 Drawer Steel Cabinet	EACH	£19.95

**BROACHES, CUTTING & SMOOTHING**

**BROACHES, CUTTING**

For the jeweller, silversmith, arts craft, contemporary jeweller, model maker, watch & clock repairer.

Use broaches like a hand file to enlarge and align holes in brass, gold, silver & copper etc. Use cutting broaches after drilling to open up slightly the holes and smoothing broaches to create a burnished inside the hole finish.

Ideal whether you're a clock maker fitting bushes or jewellery making needing a tight fit for precious metal wires for beads, earrings, bracelets, bangles or decorative finishing.

**Individuals Ø3.75 to Ø10.49mm**



Bergeon 1962 series - Cutting Broaches

- Swiss Made

- Top quality precision ground broaches for accurate work
- Size stated is the maximum cutting diameter

Code	Description	UOM	Price
B48340	Ø3.75mm Bergeon 1962-26	EACH	£4.75
B48339	Ø4.00mm Bergeon 1962-22	EACH	£4.95
B48338	Ø4.25mm Bergeon 1962-18	EACH	£5.65
B48336	Ø4.75mm Bergeon 1962-12	EACH	£6.95
B48335	Ø5.00mm Bergeon 1962-08	EACH	£7.65
B48333	Ø5.50mm Bergeon 1962-02	EACH	£8.75
B0182	Ø5.97mm Bergeon 1962A	EACH	£9.50
B0184	Ø6.15mm Bergeon 1962C	EACH	£9.50
B0186	Ø6.35mm Bergeon 1962E	EACH	£9.95
B0189	Ø6.76mm Bergeon 1962H	EACH	£9.95
B0190	Ø6.91mm Bergeon 1962I	EACH	£10.95
B0192	Ø7.14mm Bergeon 1962K	EACH	£12.60
B0193	Ø7.37mm Bergeon 1962L	EACH	£12.95
B0195	Ø7.67mm Bergeon 1962N	EACH	£12.95
B0196	Ø8.03mm Bergeon 1962O	EACH	£14.75
B0197	Ø8.20mm Bergeon 1962P	EACH	£15.95
B0198	Ø8.43mm Bergeon 1962Q	EACH	£16.50
B0199	Ø8.61mm Bergeon 1962R	EACH	£16.95
B0200	Ø8.89mm Bergeon 1962S	EACH	£17.95
B0202	Ø9.35mm Bergeon 1962U	EACH	£17.95
B0203	Ø9.58mm Bergeon 1962V	EACH	£18.95
B0206	Ø10.26mm Bergeon 1962Y	EACH	£21.95
B0207	Ø10.49mm Bergeon 1962Z	EACH	£24.25

**Ø0.05 to 0.30mm, Bergeon**



- Bergeon 1896G
- Swiss Made
- 1 tube of 12 assorted cutting broaches
- Ø0.05 to 0.30mm
- Pivot cutting broaches

Code	Description	UOM	Price
B0171	Ø0.05 to 0.30mm Cutting Broaches, Bergeon 1896G	EACH	£20.25

Includes:

- Bergeon 1896G - Ø0.05 to 0.30mm
- Bergeon 1896F - Ø0.20 to 0.80mm
- Bergeon 1896E - Ø0.20 to 1.00mm
- Bergeon 1896C - Ø0.33 to 1.04mm
- Bergeon 1896A - Ø1.14 to 2.75mm

Code	Description	UOM	Price
B0177	Ø0.05 to Ø2.75mm Cutting Broaches, Bergeon 30046	EACH	£119.95

**Ø0.20 to 0.80mm, Bergeon**



- Bergeon 1896F
- Swiss Made
- 1 Tube of 12 assorted cutting broaches
- Ø0.20 to 0.80mm

Code	Description	UOM	Price
B0170	Ø0.20mm to 0.80mm Cutting Broaches, Bergeon 1896F	EACH	£23.95

**Ø0.20 to 1.00mm, Bergeon**



- Bergeon 1896E
- Swiss Made
- 1 Tube of 12 assorted cutting broaches
- Ø0.20 to 1.00mm

Code	Description	UOM	Price
B0169	Ø0.20mm to 1.00mm Cutting Broaches, Bergeon 1896E	EACH	£23.75

**Ø0.33 to 0.69mm, Bergeon**

- Bergeon 4251
- Swiss Made
- 1 pack of 12 assorted cutting broaches
- Ø0.33 to 0.69mm



Code	Description	UOM	Price
B0173	Ø0.33 to 0.69mm Cutting Broaches, Bergeon 4251	EACH	£22.25

**Ø0.05 to 0.30mm, A\*F Swiss**



A\*F Swiss

Popular pivot broaches with each tube containing 12 broaches comprising of 4 different sizes and 3 of each size. Ideal for broaching pivot holes and well as hand collets etc.

- Sizes:
- B47545: Ø0.05 - 0.10 - 0.12 - 0.15mm

Code	Description	UOM	Price
B47545	Ø0.05 to Ø0.15mm Pivot Broach Set	PACK*12	£16.95

**Ø0.05 to 0.20mm, Bergeon**

Bergeon 3008

- Swiss Made
- 1 pack of 12 assorted cutting broaches
- Ø0.05 to 0.20mm
- Pivot cutting broaches



Code	Description	UOM	Price
B0174	Ø0.05 to 0.20mm Pivot Cutting Broaches, Bergeon 3008	EACH	£19.95

**Ø0.05 to 2.75mm, Bergeon**



- Bergeon 5310
- Swiss Made
- 3 Tubes of 12 assorted cutting broaches

- Includes:
- Bergeon 1896G - Ø0.05 to 0.30mm
  - Bergeon 1896C - Ø0.33 to 1.04mm
  - Bergeon 1896A - Ø1.14 to 2.75mm

Code	Description	UOM	Price
B0208	Ø0.05 to 2.75mm Cutting Broaches, Bergeon 1896A, C & G	EACH	£79.95

**Ø0.05 to 2.75mm, Bergeon**



- Bergeon 30046
- Swiss Made
- 5 Tubes of 12 assorted cutting broaches





## Ø0.33 to 1.04mm, Bergeon



- Bergeon 1896C
- Swiss Made
- 1 Tube of 12 assorted cutting broaches
- Ø0.33 to 1.04mm

Code	Description	UOM	Price
B0167	Ø0.33 to 1.04mm Cutting Broaches, Bergeon 1896C	EACH	£17.50

## Ø0.45 to 1.40mm, German



- German manufacture
- 1 Pack of 6 assorted cutting broaches with plastic handles
- Ø0.45 to 1.40mm

Code	Description	UOM	Price
B36682	Ø0.45 to 1.40mm Cutting Broach Set	PACK*6	£8.75

## Ø0.46 to 1.90mm, Bergeon

- Bergeon 4338
- Swiss Made
- 1 pack of 12 assorted cutting broaches
- Ø0.46 to 1.90mm



Code	Description	UOM	Price
B0175	Ø0.46 to 1.90mm Cutting Broaches, Bergeon 4338	EACH	£26.35

## Ø0.60 to 2.00mm, German



- German manufacture
- 1 Pack of 6 assorted cutting broaches with plastic handles
- Ø0.60 to 2.00mm

Code	Description	UOM	Price
B36683	Ø0.60 to 2.00mm Cutting Broach Set	PACK*6	£9.25

## Ø0.61 to 1.90mm, Bergeon



- with Pin Vice
- Bergeon 4982
- Swiss Made
- Includes Bergeon 1842-18A Pin Vice with 2 chucks
- 1 Tube of 12 assorted cutting broaches with PVC Handles
- Ø0.61 to 1.90mm

Code	Description	UOM	Price
B0180	Ø0.61 to 1.90mm Cutting Broaches with Pin Vice, Bergeon 4982	EACH	£28.50

## Ø0.70 to 2.90mm, Bergeon



- Bergeon 30544AP
- Swiss Made
- 1 box of 7 assorted cutting broaches with knurled handles
- Ø0.70 to 2.90mm

Code	Description	UOM	Price
B0176	Ø0.70 to 2.90mm Cutting Broaches, Bergeon 30544A	EACH	£51.95

## Ø0.70 to 3.00mm, German



- German manufacture
- 1 Pack of 6 assorted cutting broaches with plastic handles
- Ø0.70 to 3.00mm

Code	Description	UOM	Price
B36684	Ø0.70 to 3.00mm Cutting Broach Set	PACK*6	£10.65

## Ø0.80 to 2.30mm, Indian



- 1 Wallet of 6 assorted cutting broaches with handle
- Ø0.80mm
- Ø1.00mm
- Ø1.30mm
- Ø1.60mm
- Ø2.00mm
- Ø2.80mm

Size stated is the maximum cutting diameter (approx.)

Made in India

Code	Description	UOM	Price
B34933	0.80-2.30mm Cutting Broaches with Handle,	EACH	£5.95

## Ø1.14 to 2.75mm, Bergeon



- Bergeon 1896A
- Swiss Made
- 1 Tube of 12 assorted cutting broaches
- Ø1.14 to 2.75mm

Code	Description	UOM	Price
B0165	Ø1.14 to 2.75mm Cutting Broaches, Bergeon 1896A	EACH	£26.25

### Deburring Tool

See Page 903



- Bergeon 30544AP
- Swiss Made
- 1 box of 7 assorted cutting broaches with knurled handles
- Ø0.70 to 2.90mm

Code	Description	UOM	Price
B0176	Ø0.70 to 2.90mm Cutting Broaches, Bergeon 30544A	EACH	£51.95

### Mechanics Scrapers

See Page 905



**Ø1.20 to 3.00mm, German**



- German manufacture
- 1 Pack of 6 assorted cutting broaches with plastic handles
- Ø1.20 to 3.00mm

Code	Description	UOM	Price
B36685	Ø1.20 to 3.00mm Cutting Broach Set	PACK*6	£13.25

**Ø2.20 to 6.00mm, German**



- German manufacture
- 1 Pack of 6 assorted cutting broaches with plastic handles
- Ø2.20 to 6.00mm

Code	Description	UOM	Price
B0179	Ø2.20 to 6.00mm Cutting Broaches, German	PACK*6	£37.95

**Ø2.40 to 6.20mm, Indian**



- 1 Wallet of 6 assorted cutting broaches with handle.
- Ø2.40mm
  - Ø2.70mm
  - Ø3.20mm
  - Ø4.20mm
  - Ø5.00mm
  - Ø6.20mm

Size stated is the maximum cutting diameter (approx.)  
Made in India

Code	Description	UOM	Price
B34934	Ø2.40-6.20mm Cutting Broaches with Handle	EACH	£12.25

**Ø2.69 to 5.97mm, Bergeon**



- Bergeon 6013
- Swiss Made
- 1 Tube of 6 assorted cutting broaches
- Ø2.69 to 5.97mm

Code	Description	UOM	Price
B0178	Ø2.69 to 5.97mm Cutting Broaches, Bergeon 6013	EACH	£33.65

**BROACHES, SMOOTHING**



*For the jeweller, silversmith, arts craft, contemporary jeweller, model maker, watch & clock repairer.*

*Use broaches like a hand file to enlarge and align holes in brass, gold, silver & copper etc. Use cutting broaches after drilling to open up slightly the holes and smoothing broaches to create a burnished inside the hole finish.*

*Ideal whether you're a clock maker fitting bushes or jewellery making needing a tight fit for precious metal wires for beads, earrings, bracelets, bangles or decorative finishing.*

**Ø0.05 to 0.30mm, Bergeon**



- Bergeon 1896H
- Swiss Made
- 1 Tube of 12 assorted smoothing broaches
- Ø0.05 to 0.30mm

Code	Description	UOM	Price
B0172	Ø0.05 to 0.30mm Smoothing Broaches, Bergeon 1896H	EACH	£21.95

**Hand Held Vice**

See Page 1048

**Large Pin Vice**  
jaws open to 7mm

See Page 939

**Ø0.05 to 2.75mm, Bergeon**



- Bergeon 30075
- Swiss Made
- 3 Tubes of 12 assorted smoothing broaches

Includes:

- Bergeon 1896H: Ø0.05 to 0.30mm
- Bergeon 1896D: Ø0.33 to 1.04mm
- Bergeon 1896B: Ø1.14 to 2.75mm

Code	Description	UOM	Price
B4861	Ø0.05 to 2.75mm Smoothing Broaches, Bergeon 30075	EACH	£79.95

**Ø0.33 to 1.04mm, Bergeon**



- Bergeon 1896D
- Swiss Made
- 1 Tube of 12 assorted smoothing broaches
- Ø0.33 to 1.04mm

Code	Description	UOM	Price
B0168	Ø0.33 to 1.04mm Smoothing Broaches, Bergeon 1896D	EACH	£16.75

**Ø0.40 to 1.40mm, German**



- German manufacture
- 1 Pack of 6 assorted smoothing broaches with plastic handles
- Ø0.40 to 1.40mm

Code	Description	UOM	Price
B36686	Ø0.40 to 1.40mm Smoothing Broach Set	PACK*6	£9.50

**PRICE PROMISE GUARANTEE**

## Ø0.60 to 2.00mm, German



- German manufacture
- 1 Pack of 6 assorted smoothing broaches with plastic handles
- Ø0.60 to 2.00mm

Code	Description	UOM	Price
B36687	Ø0.60 to 2.00mm Smoothing Broach Set	PACK*6	£10.95

## Ø0.70 to 2.90mm, Bergeon



- Bergeon 30543A
- Swiss Made
- 1 box of 7 assorted smoothing broaches with knurled handles
- Ø0.70 to 2.90mm

Code	Description	UOM	Price
B0209	Ø0.70 to 2.90mm Smoothing Broaches, Bergeon 30543A	EACH	£46.75

## Ø0.70 to 3.00mm, German



- German manufacture
- 1 Pack of 6 assorted smoothing broaches with plastic handles
- Ø0.70 to 3.00mm

Code	Description	UOM	Price
B36688	Ø0.70 to 3.00mm Smoothing Broach Set	PACK*6	£15.50

## Ø1.14 to 2.75mm, Bergeon



- Bergeon 1896B
- Swiss Made
- 1 Tube of 12 assorted smoothing broaches
- Ø1.14 to 2.75mm

Code	Description	UOM	Price
B0166	Ø1.14 to 2.75mm Smoothing Broaches, Bergeon 1896B	EACH	£26.95

## Ø1.20 to 3.00mm, German



- German manufacture
- 1 Pack of 6 assorted smoothing broaches
- Ø1.20 to 3.00mm

Code	Description	UOM	Price
B36689	Ø1.20 to 3.00mm Smoothing Broach Set	PACK*6	£12.50

## Ø2.20 to 6.00mm, German



- German manufacture
- 1 Pack of 6 assorted smoothing broaches
- Ø2.20 to 6.00mm

Code	Description	UOM	Price
B0210	Ø2.20 to 6.00mm Smoothing Broaches, German	PACK*6	£27.50

# BRUSHES

## ART BRUSHES

### Cousins Range of artist brushes

- These brushes contain the finest natural horse/bristle hair quality.
- Wood handles are made from selected timbers.
- Used by jewellers, silversmiths, model makers, arts/crafts light engineer's sculptors and artists.
- Use these high quality brushes to apply flux or fire coating.
- Durable natural-hair makes the application of flux and other liquids extremely easy and smooth.

### Art Brushes



- Pencil Brush ('Polysset')
- Red Lacquered handles
- Soft Hair brush

#### Dimensions:

- Brush thickness, overall length x brush diameter at ferrule

Code	Description	UOM	Price
B9625A	00 (Extra Fine) 170 x Ø1.50mm	EACH	£1.10
B9625	2 (Fine) 170 x Ø2.40mm	EACH	£1.15
B9624	4 (Medium) 180 x Ø2.50mm	EACH	£1.25
B9623	6 (Thick) 180 x Ø4.00mm	EACH	£1.45

Price breaks available, see website

### Hiqual Art Brushes



Superior quality for fine and delicate work.

- Hiqual Pencil Brush
- Black Lacquered handles
- Gold Synthetic Hair

#### Dimensions:

- Brush thickness, overall length x brush diameter at ferrule

Code	Description	UOM	Price
B9627	0 (Extra Fine) 160 x Ø2.00mm	EACH	£2.95
B9628	2 (Fine) 160 x Ø2.40mm	EACH	£3.45
B9629	4 (Medium) 170 x Ø2.80mm	EACH	£3.95

Price breaks available, see website

### Sable Hair Art Brush



- Pencil Brush
- Wooden Handles
- Genuine sable hair

#### Dimensions:

- Brush thickness, overall length x brush diameter at ferrule

Code	Description	UOM	Price
B45714	1 (Fine) 190 x Ø2.00mm	EACH	£0.95
B45715	5 (Medium) 200 x Ø3.30mm	EACH	£0.95
B45716	12 (Large) 220 x Ø6.00mm	EACH	£0.95

## BRASS BRUSHES

Brass is a softer wire than stainless steel, and brass brushes are ideal for applications where you do not want to scratch other surfaces. Our brass brushes are made with finest alloy used, and are resistant to rust and corrosion.

### Brass Brush Applications

- Satin or lustre finishing
- Surface cleaning
- Burnishing
- Polishing
- Debarring
- Material removal

### Brass Scratch Brush



Ideal for cleaning battery contacts, jewellery burrs, drills, taps & dies.

#### Refills

- B5010 = B0231
- B31640 = Non Refillable

Code	Description	UOM	Price
B5010	Brass Scratch Brush	EACH	£1.95
B31640	Metal Pen Brass Scratch Brush	EACH	£21.95
Price breaks available, see website			

### Brass Scratch Brush Refills

- Pack\*10
- 44mm long
- 4.30mm neck



Code	Description	UOM	Price
B41137	Brass Scratch Brush Refills	PACK*10	£2.90

### Brass Scratch Brush Refills, German

- 24pcs
- 44mm long
- 4.30mm neck
- Made in Germany



Code	Description	UOM	Price
B0231	Brass Scratch Brush Refills	PACK*24	£11.75

### Brass Scratch Brush, Flat Style

#### B4819:

- Made in UK
- Crimped brass
- Sliding neck
- 70 x 25 x 2mm



#### B6690:

- Bergeon 2272
- Crimped brass
- Sliding neck
- 70 x 25 x 2mm

Code	Description	UOM	Price
B4819	Brass Scratch Brush, Flat Style - Made in UK	EACH	£1.20
B6690	Brass Scratch Brush, Flat Style - Bergeon Swiss	EACH	£8.95
Price breaks available, see website			

## Hand Held Brass Brushes



Brass Brushes hand held are excellent for pre-polishing an item, removing excess solder from a piece after it has cooled and to achieve a satin "brushed" metal look.

- It is advised that you use the brush with water and soap as a lubricant when polishing your precious metals to avoid the risk of small parts of brass being deposited from the brush which may give your metal a dull appearance.
- Use fine grade abrasive paper for this type of work also to avoid shiny scratch marks getting a pleasant looking soft shine effect
- Available in a variety of sizes, fine wire grade

Code	Description	UOM	Price
B34949	3 Row Brass Brush	EACH	£1.95
B0219	4 Row Brass Brush, German	EACH	£4.95
B34948	5 Row Brass Brush, Indian	EACH	£1.95
B36655	5 Row Brass Brush, UK	EACH	£4.95
B0220	6 Row Brass Brush, UK	EACH	£7.95
B36656	6 Row Brass Brush, UK	EACH	£4.95
Price breaks available, see website			

## BRISTLE BRUSHES

We have an ideal range of bristle brushes that will cater for all your cleaning, hand polishing and adhesive applying needs, as well as any other application you can think of!

Available in various shapes/grades, carefully selected for you from all over the globe.

### Bench Brush

CousinsUK traditional bench sweeping brushes. Comprising of soft nylon or natural bristles mounted on a light weight wooden handle, ideal for sweeping your precious metal.

### Bench Brush, Natural Bristles

- 7 rows
- Natural bristles
- Bristle length 35mm
- Made in India



Code	Description	UOM	Price
S39279	Bench Brush, Natural Bristles	EACH	£2.75

### Bench Brush, Nylon Bristles

- 4 rows
- Nylon bristles
- Bristle length 35mm
- Made in India



Code	Description	UOM	Price
B35085	Bench Brush, Nylon Bristles	EACH	£3.40

### Bench Brush, Nylon Bristles - Without Handle



- 11 rows
- Nylon bristles
- Bristle length 25mm
- "Shoe shine" type
- Made in India

Code	Description	UOM	Price
S39278	Bench Brush, Nylon Bristles - Without Handle	EACH	£2.75

### Borax Brush



Jewellery/Silversmith natural horse hair flux brushes.

- Short, light weighted brush specifically made for applying flux when soldering gold, silver, brass, copper etc.
- Completely metal free so no chance of contaminating your solder joints. Often you can find borax brushes with metal crimps holding the hairs, thus causing rust deposits to contaminate the item you are soldering.

Code	Description	UOM	Price
B9630	50mm Borax Brush, Small	EACH	£0.75
B9633	70mm Borax Brush, Medium	EACH	£0.80
Price breaks available, see website			

### Cleaning Brush

General use cleaning brushes

- Natural or Nylon Bristles
- Plastic or Wooden Handles
- Various Lengths

### Natural Bristles, Wooden Handle - Vertical



- Natural bristles
- Vertical
- Overall length 145mm

Code	Description	UOM	Price
S39289	Natural Bristles, Wooden Handle - Vertical	EACH	£1.50

### Nylon Bristles, Plastic Handle



- Nylon bristles
- Plastic handle
- Overall length 115mm

Code	Description	UOM	Price
S39290	Nylon Bristles, Plastic Handle	EACH	£0.95

IMPROVED  
SPEED SEARCH

SECURE  
ONLINE ORDERING

## Nylon Bristles, Wooden Handle



- Nylon Bristles
- Wooden handle
- Overall length 145mm

Code	Description	UOM	Price
S39291	Nylon Bristles, Wooden Handle	EACH	£1.50

## Dust Off Brush



- Medium bristle

Code	Description	UOM	Price
B9636	Ø10mm Medium Bristle Dust Off Brush	EACH	£1.50
B9637	Ø18mm Medium Bristle Dust Off Brush	EACH	£1.75

## Natural Bristle Brushes, Handheld



Wide section of white natural bristle brushes available in different grades, mounted on natural wooden handle.

- Very soft, soft, medium & hard bristles all available
- 4, 5 or 6 row
- A\*F Swiss

Code	Description	UOM	Price
B0215	Very Soft, A*F Swiss - 4 Row	EACH	£5.50
B0214	Soft, A*F Swiss - 4 Row	EACH	£5.65
B45713	Soft, Inidan - 4 Row	EACH	£2.75
B0213	Medium Hard, A*F Swiss - 4 Row	EACH	£6.15
B0212	Hard, A*F Swiss - 4 Row	EACH	£6.85
B0217	Hard, A*F Swiss - 5 Row	EACH	£7.95
B0216	Hard, A*F Swiss - 6 Row	EACH	£6.95

## Nylon Bristle Brushes, Handheld



Wide section of white nylon bristle brushes available in different grades, mounted on natural wooden handle.

- Soft, medium and stiff nylon all available

- 4, 5 or 6 row
- Made in India

Code	Description	UOM	Price
B34944	Soft, 4 Row	EACH	£1.50
B35075	Medium, 6 Row	EACH	£1.50
S39286	Hard, 4 Row	EACH	£1.50
S39287	Hard, 6 Row	EACH	£1.50

## Nylon Bristle Brush, Flat Style

- Flat style
- Nylon
- Sliding neck
- 70 x 25 x 2 mm



Code	Description	UOM	Price
B31643	Nylon Scratch Brush Flat Style	EACH	£1.60
Price breaks available, see website			

## Palate Brush

With moulded plastic unbreakable stocks, they are 9 knot 3/4" diameter brushes with stiff black bristles capable of reaching into the deepest palate.

- Also very useful for finishing cylinders, vases, cups etc.
- Not only you can mount on a normal polishing motor spindles, you can mount it on pendant/flexi cable spindles.
- Use a threaded taper mandrel for pendant drills (code P1345M) and for flexible drive shafts use a pigtail spindle code (C3350).



Dimensions:

- Overall length 55mm
- Bristle length 20mm
- Shank diameter Ø10mm
- Mounting hole diameter Ø4.50mm

Code	Description	UOM	Price
P31641	Ø14mm Palate Brush Black Bristle Extra Stiff	EACH	£1.95
Price breaks available, see website			

## Sash Bristle Brushes



- America's Salmon Products soft bristle brushes are tapered and finished smoothly whilst comprising a comfortable wooden handle.
- Suitable for fluxing, soldering, applying adhesives, watch and clock cleaning fluids.

Code	Description	UOM	Price
B34118	Ø18mm Sash Brush (Number 10)	EACH	£2.40
B34119	Ø22mm Sash Brush (Number 12)	EACH	£2.95
B34120	Ø30mm Sash Brush (Number 16)	EACH	£3.35
Price breaks available, see website			

**TODAY** SAME DAY DISPATCH

## Surgeon's Hand Scrub Brush

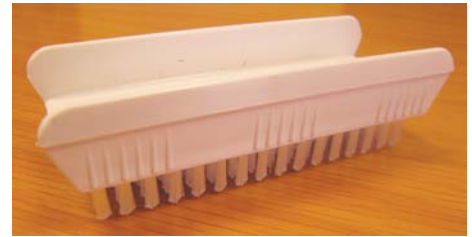

A very handy cleaning brush to thoroughly clean your hands, fingers and whatever you dare after a hard day at work in your workshop. Particularly excellent to clean out the dirt from under your fingernails.

- White nylon bristles
- Size: 104 x 40 x 32mm
- Autoclavable

Code	Description	UOM	Price
B31642	Surgeon's Hand Scrub Brush	EACH	£1.10
Price breaks available, see website			

## Wash Out Brushes

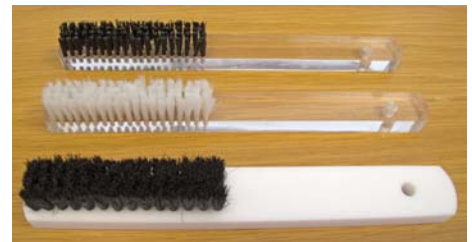

Very useful for cleaning ultrasonic tanks and other equipment and tools.

Also Ideal for cleaning out polishing composition and second hand jewellery/watches, particularly behind a stone set piece if one does not have an ultrasonic at hand. Simply run water from your tap over your item and because of the unique stiff bristles, it will clean into the most intricate spaces.

- Hand held
- Plexi glass handles (clear or white)
- Nylon bristles
- Hard or soft bristles
- 4 or 3 rows
- Washout
- Mad in India

Code	Description	UOM	Price
B35076	Hard Bristle Brush (4 Row), Clear Handle	EACH	£3.50
S39288	Soft Bristle Brush (4 Row), Clear Handle	EACH	£3.95
B46143	Soft Bristle Brush (3 Row), White Handle	EACH	£3.95

## FIBREGLASS SCRATCH BRUSHES

Fibre Glass Scratch Brushes are very useful in your workshop and have a wide number of applications:

- Available in many shapes & styles with refills readily available.
- Ideal for surface cleaning and removing corrosion on watch battery contacts.
- Can use before precious metal acid testing, removing suspected plate metal.
- Create a unique texturing effect, just like many contemporary artists and jewellery makers do.
- A quick test for diamonds, if the brush scratches it, then it isn't real.
- Please note one should take care when

using not to run on skin as fine hairs may penetrate causing discomfort.

## Scratch Brush, Cousins Set



This is an excellent set consisting of the 3 main brushes any watch or clock maker or jeweller could need. All with a comfortable plastic body, colour coded for ease of use.

- Fibreglass scratch brush: A wide range of uses, including removing suspected plate metal before acid testing, creating a unique texturing effect or a quick test for checking if a diamond is real
  - Brass scratch brush: Ideal for cleaning battery contacts, jewellery burrs, drills, taps & dies
  - Steel scratch brush: Excellent for removing oxidation marks off harder metals
  - 120mm long
- Refills:
- Brass: Code B41137
  - Fibreglass: Code B41136
  - Steel: Code B41138

Code	Description	UOM	Price
B35083	Scratch Brush Set	PACK*3	£5.45

## Scratch Brush, Cousins



Fibreglass Scratch Brush - Cousins

- Popular Pen Type
- 12cm Length
- Refill Pack B0230

Propelling pencil action exposes more of the glass fibres.

The shorter the fibres showing the more abrasive the action.

Code	Description	UOM	Price
B0226	Fibreglass Scratch Brush	EACH	£1.40

## Scratch Brush, Bergeon



Fibreglass Scratch Brush - Bergeon 2834C

- Bergeon Swiss
- Popular Pen Type
- 12cm Length
- Refill Pack B0230

Code	Description	UOM	Price
B0225	Bergeon 2834C Fibreglass Scratch Brush	EACH	£8.75

## Scratch Brush Refills

- 10 pieces
- Popular Pen Type
- 40mm Long x 4.3mm Neck
- Standard Type



Code	Description	UOM	Price
B41136	Glass Scratch Brush Refills	PACK*10	£3.50

## Scratch Brush Refills, German

- 24 pieces
- Popular Pen Type
- 40mm Long x 4.3mm Neck
- Standard Type
- Made in Germany



Code	Description	UOM	Price
B0230	Glass Scratch Brush Refills	PACK*24	£8.85

## Scratch Brush, Narrow, Cousins



- Pen Type Ø7mm
- 2mm Nib
- 5cm Long
- Refills = B0224

Same applications as larger brushes but for use on smaller and less accessible areas.

Code	Description	UOM	Price
B0223	Fibreglass Scratch Brush, Narrow	EACH	£4.50

## Scratch Brush, Narrow Refills, Cousins



- 12 pieces
- Ø2mm
- Narrow Pen Type

Code	Description	UOM	Price
B0224	Glass Scratch Brush Refills Ø2.0mm	PACK*12	£7.75

## Scratch Brush, Roped



These 180mm long brushes are for use on larger areas. To expose more fibres, simply pull back the string. We recommend that you use insulation tape around the brush to avoid getting fibre glass splinters.

- Various diameters available.

Code	Description	UOM	Price
B0228	Ø10mm Glass Fibre Scratch Brush	EACH	£6.95

B36962	Ø17mm Glass Fibre Scratch Brush	EACH	£7.95
--------	---------------------------------	------	-------

## FILE CLEANING BRUSH

### File Cleaning Brush



Used for cleaning metal and wooden files, removes embedded filings far more effectively than an ordinary wire brush.

- Quality
- Faithful file cleaning brush
- Fine wire bristles sit on a traditional wooden handle

Size and weight:

- Overall size 240mm x 40mm x 20mm
- 76g

Code	Description	UOM	Price
B33137	Brush for Cleaning Files	EACH	£2.90

## STEEL BRUSHES

### Medium Steel Cleaning Brush



- Crimped medium firm
- 14cm long overall

Code	Description	UOM	Price
B9635	Steel Cleaning Brush Crimped Medium Firm	EACH	£5.90

### Hard Steel Cleaning Brush



- 4 Row
- Firm Tines
- 31cm long overall

Code	Description	UOM	Price
B9634	Steel Wire Brush 4 Row Firm Tines	EACH	£3.30

### Steel Scratch Brush Refills

- Pack\*10
- Popular Pen Type
- 40mm Long x 4.3mm Neck
- Standard Type



Code	Description	UOM	Price
B41138	Steel Scratch Brush Refills	PACK*10	£2.90



Online  
Discounts

**BURRS (FRAISES) & FLY CUTTERS**

A\*F and Bush burrs are made in the EU which embrace exceptional quality and cutting shape edge superiority, expect only the best

- Some of the popular style stone steel burr shapes are used for setting
- We stock a wide variety of sizes and shapes which cater for all your stone settings needs
- See the associated links for an excellent choice of practical stone setting books and equipment. We also recommend if you have not stone set before attend a course
- Various courses are available around the country at various colleges and universities. Remember practice is essential to become a quality stone setter
- Burrs are also popular for use when engraving, texturing and grinding.
- We have put some popular styles of setting/working practices when they use Cousins Material House steel burrs.

*Ball Burrs: the most popular steel burrs used in jewellery stone setting, with its all round shape*  
*Bearing Cutter 90° Burrs: the angle of this burr reflects the popular cut diamonds' right angle*  
*Bud tapered burrs: very popular for forming channel setting grooves, particularly on wedding rings.*

*Concave Cutter Cup Burrs: to round off end points of various sizes of metal, for example on a claw set ring.*

*Flame burrs: very useful to open out casting flash (a slight film of metal over a whole/crevice).*

*Knife Edge Cutting Burr: perfectly textures deep grooves on jewellery.*

Some basic diamond terms:

- **Facet:** a small surface side of a gemstone.
- **Table:** the large flat top facet. It has an octagonal shape on a round brilliant diamond.
- **Crown:** the upper part of the diamond above the girdle.
- **Girdle:** the narrow rim around the diamond. The girdle plane is parallel to the table and is the largest diameter of any part of the stone.
- **Pavilion:** the lower part of the diamond below the girdle. It has a cone shape on round diamonds.
- **Culet:** the tiny facet on the pointed bottom of the pavilion, parallel to the table.

**BURR LUBRICANT**

**Burr Lubricant Wax**

Burr Lubricant Wax



- Extends the life of burrs, saw blades, drills, gravers, taps & dies & diamond tools etc.
- Eliminates burr chatter to give smooth stone seats on settings
- Cleaner and easier to use than oils etc.
- Supplied in handy pad

Code	Description	UOM	Price
<b>O45554</b>	Burr Lubricant Wax	EACH	<b>£2.95</b>

**Burr Lubricant Wax, USA**

Burr "Cut-Lube" Lubricant Wax



Unique lubricant in a handy stick dispenser for use with burrs, drills, gravers, saw blades etc. to reduce pull and drag. Adds life to your tools by reducing friction and is much easier and cleaner to use than messy oils.

The non-petroleum formula also helps prevent Burr chatter and ensures a smooth, even stone seat on your setting. Also good for diamond tools.

- An amazing space-age lubricant which reduces pull and drag by reducing friction
- Extends the life of burrs, saw blades, drills, gravers, taps & dies & diamond tools etc.
- Eliminates burr chatter to give smooth stone seats on settings
- Cleaner and easier to use than oils etc.
- Supplied in handy stick dispenser
- Made in USA

Code	Description	UOM	Price
<b>B4181</b>	Burr Cut-Lube Lubricant Wax, A*F Swiss	EACH	<b>£3.95</b>

**ROTARY BURNISHERS (POROSITY REMOVERS)**

**Rotary Burnisher, A\*F Swiss**



- A\*F Swiss
- Porosity removers for platinum, gold and silver
- These cylindrical burnishers are a remarkably rapid and efficient way of removing porosity, scratches and fire scale from precious metal castings
- Extremely long-lasting, excellent value
- Made from highly polished tungsten carbide, the burnishers have either 12, 18 or 36 facets on the sides to eliminate pores and produce the desired effect
- Mounted on standard shanks 2.35mm (3/32") – Maximum working speed 10,000rpm

Code	Description	UOM	Price
<b>B9579C</b>	Fine (36 facets) Rotary Burnisher	EACH	<b>£56.50</b>
<b>B9579B</b>	Medium (18 facets) Rotary Burnisher	EACH	<b>£56.50</b>
<b>B9579A</b>	Coarse (12 facets) Rotary Burnisher	EACH	<b>£56.50</b>

**Freedom Micromotors**  
 See Page 684

**DIAMOND FLY CUTTERS**

**Diamond Fly Cutters**



These high quality tools are designed to create beautiful designs on jewellery, especially charms, bangles, earrings etc. Made for the professional craftsman to produce bright facets, backgrounds, cuts for setting stones etc., in gold and other precious metals.

The cutting edge is a chip produced from top grade, industrial diamond set in steel. Available in several angles and two shank diameters, popular 3mm & 4mm. Best used in handpieces at speeds between 30,000 & 35,000 rpm.

- American made
- Length 32mm
- Shaft Ø3mm or 4mm

Due to the nature of these tools the manufacturer does not offer a warranty.

Code	Description	UOM	Price
<b>F47553</b>	90° Diamond Fly Wheel (3mm Shank)	EACH	<b>£48.95</b>
<b>F47558</b>	90° Diamond Fly Wheel (4mm Shank)	EACH	<b>£48.95</b>
<b>F47554</b>	120° Diamond Fly Wheel (3mm Shank)	EACH	<b>£48.95</b>
<b>F47559</b>	120° Diamond Fly Wheel (4mm Shank)	EACH	<b>£48.95</b>
<b>F47555</b>	130° Diamond Fly Wheel (3mm Shank)	EACH	<b>£48.95</b>
<b>F47560</b>	130° Diamond Fly Wheel (4mm Shank)	EACH	<b>£48.95</b>
<b>F47556</b>	150° Diamond Fly Wheel (3mm Shank)	EACH	<b>£48.95</b>
<b>F47561</b>	150° Diamond Fly Wheel (4mm Shank)	EACH	<b>£48.95</b>
<b>F47557</b>	180° Diamond Fly Wheel (3mm Shank)	EACH	<b>£48.95</b>
<b>F47562</b>	180° Diamond Fly Wheel (4mm Shank)	EACH	<b>£48.95</b>

**DIAMOND BURRS**



- A\*F Swiss diamond impregnated burrs are a world favourite for generations excellent high quality and very durable.
- Cousins diamond impregnated burr sets

also available singularly. Exceptional value, durable & long life usage.

- Value diamond burrs give a super and smooth finish on metal, glass and stone. Several shapes and sizes organised in a plastic container.

A wide variety of sets and singular diamond burrs are available. Electroplated diamond particles are the ultimate material for all metal removing/texturing. Add a fine fantastic texturing effect on jewellery. When texturing with these burrs the unique diamond particles will transfer the effect onto the piece leaving the same glittering finish on the jewellery as is on the burr. i.e. The finish looks like glitter has been sprinkled onto the piece. This style is one of the most popular texturing effects in Asian Jewellery before the diamond milling process known as the Shubnum effect.

- Grinds/smoothes away excess metal such as solder
- Used in the glass, engraving and sculpture industry puts a misty / frosty effect on glass
- 140/170 grits
- Shank body size Ø2.35mm or 3/32", which can be used in micromotors and standard quick release hand pieces, (making it easy to change burrs quickly and easily) as well as conventional chuck hand pieces
- Are very popular with jewellers, silversmiths, watch makers/repairers, light engineers, model makers plastic fabricators and in arts and crafts
- Can be used on a whole range of materials such as gold, silver, platinum, copper, brass, pewter, bronze, glass and aluminium
- Finest quality for reliability, long life and satisfaction guaranteed

For glass engraving / texturing & reaming stones and beads, always use water as a lubricant with diamond tools / instruments. No lubrication required for texturing on metal.

**A\*F Swiss Spherical, Cylindrical and Points Set**

**Set (01 to 12), A\*F Swiss**



- Ø2.35mm shank
- Total length 44.5mm
- Set of 12 pieces
- A\*F Swiss 119351.01 to 119351.12
- Excellent set for specific accurate work, very good variety
- Multi-use set comes with a wide variety of burrs, including:

Shapes:

- (01) Cone
- (02) Flame Small
- (03) Flame Medium
- (04) Inverted Cylinder Cone
- (05) Tapered Cylinder Large
- (06) Cylinder Medium
- (07) Cylinder Small

- (08) Ball Small
- (09) Ball Medium
- (10) Ball Large
- (11) Ball Extra Large
- (12) Knife Edge Fine

Code	Description	UOM	Price
119351	Set (01 to 12), A*F Swiss	PACK*12	£45.95

**(01) Cone**



- Cone
- 3.5mm x 6.5mm

Code	Description	UOM	Price
11935101	(01) Cone	EACH	£6.25

**(02) Small Flame**



- Small Flame
- 0.9mm x 4.5mm

Code	Description	UOM	Price
11935102	(02) Small Flame	EACH	£4.25

**(03) Medium Flame**



- Medium Flame
- 1.4mm x 10mm

Code	Description	UOM	Price
11935103	(03) Medium Flame	EACH	£4.25

**(04) Inverted Cylinder Cone**



- Inverted Cylinder Cone
- 1.7mm x 5mm

Code	Description	UOM	Price
11935104	(04) Inverted Cylinder Cone	EACH	£4.25

**(05) Large Tapered Cylinder**



- Large Tapered Cylinder
- 6mm x 10mm

Code	Description	UOM	Price
11935105	(05) Large Tapered Cylinder	EACH	£9.09

**(06) Medium Cylinder**



- Medium Cylinder
- 2.5mm x 7mm

Code	Description	UOM	Price
11935106	(06) Medium Cylinder	EACH	£5.25

**(07) Small Cylinder**



- Small Cylinder
- 1.9mm x 7mm

Code	Description	UOM	Price
11935107	(07) Small Cylinder	EACH	£4.25

**(08) Small Ball**



- Small Ball
- Ø1mm

Code	Description	UOM	Price
11935108	(08) Small Ball	EACH	£4.25

**(09) Medium Ball**



- Medium Ball
- Ø2mm

Code	Description	UOM	Price
11935109	(09) Medium Ball	EACH	£4.25

**(10) Large Ball**



- Large Ball
- Ø3mm

Code	Description	UOM	Price
11935110	(10) Large Ball	EACH	£4.50

**(11) Extra Large Ball**



- Extra Large Ball
- Ø4mm

Code	Description	UOM	Price
11935111	(11) Extra Large Ball	EACH	£5.65

**(12) Fine Knife Edge**



- Fine Knife Edge
- 3.8mm x 5mm

Code	Description	UOM	Price
11935112	(12) Fine Knife Edge	EACH	£4.90

**Micromotor, Variable Speed, Marathon**



**See Page 688**



***A\*F Swiss Tapers, Cones and Inverts Set***

**Set (01 to 12), A\*F Swiss**



Tapers, Cones & Inverts

- Ø2.35mm shank
- Total length 44.5mm
- Set of 12 pieces
- A\*F Swiss 119350.01 to 119350.12
- Excellent set for precise accurate work, very good variety
- Versatile set comes with a wide selection of burrs

Shapes:

- (01) Cylinder Round Nose
- (02) Cylinder Round Nose Small
- (03) Tapered Fine Point
- (04) Cylinder Extra Large
- (05) Tapered Cylinder Round Nose Extra Large
- (06) Parallel
- (07) Tapered Point Medium
- (08) Tapered Point Small
- (09) Inverted Cone Shallow
- (10) Inverted Cone Shallow Small
- (11) Inverted Cone Medium
- (12) Inverted Cone Small

Code	Description	UOM	Price
119350	Set (01 to 12), A*F Swiss	PACK*12	£54.95

**(01) Round Nose Cylinder**



- Round Nose Cylinder
- 3mm x 12mm

Code	Description	UOM	Price
11935001	(01) Round Nose Cylinder	EACH	£5.35

**(02) Small Round Nose Cylinder**



- Small Round Nose Cylinder
- 2mm x 12mm

Code	Description	UOM	Price
11935002	(02) Small Round Nose Cylinder	EACH	£4.50

**(03) Fine Tapered Point**



- Fine Tapered Point
- 1.5mm x 10mm

Code	Description	UOM	Price
11935003	(03) Fine Tapered Point	EACH	£4.75

**(04) Large Cylinder**



- Extra Large Cylinder
- 6mm x 11mm

Code	Description	UOM	Price
11935004	(04) Large Cylinder	EACH	£9.10

**(05) Round Nose Large Tapered Cylinder**



- Round Nose Extra Large Tapered Cylinder
- 7mm x 12mm

Code	Description	UOM	Price
11935005	(05) Round Nose Large Tapered Cylinder	EACH	£12.20

**(06) Parallel**



- Parallel
- 3mm x 10mm

Code	Description	UOM	Price
11935006	(06) Parallel	EACH	£5.25

**(07) Medium Tapered Point**



- Medium Tapered Point
- 2mm x 8mm

Code	Description	UOM	Price
11935007	(07) Medium Tapered Point	EACH	£4.50

**(08) Small Tapered Point**



- Small Tapered Point
- 1.5mm x 4.5mm

Code	Description	UOM	Price
11935008	(08) Small Tapered Point	EACH	£5.10

**(09) Shallow Inverted Cone**



- Shallow Inverted Cone
- 6mm x 1.6mm

Code	Description	UOM	Price
11935009	(09) Shallow Inverted Cone	EACH	£5.45

**(10) Small Shallow Inverted Cone**



- Small Shallow Inverted Cone
- 4mm x 0.8mm

Code	Description	UOM	Price
11935010	(10) Small Shallow Inverted Cone	EACH	£4.95

**(11) Medium Inverted Cone**



- Medium Inverted Cone
- 2.5mm x 2mm

Code	Description	UOM	Price
11935011	(11) Medium Inverted Cone	EACH	£4.50

**(12) Small Inverted Cone**



- Small Inverted Cone
- 2mm x 1.6mm

Code	Description	UOM	Price
11935012	(12) Small Inverted Cone	EACH	£4.50

***Cousins Assorted Shapes Set***

**Regular Size Diamond Impregnated Burr Set**

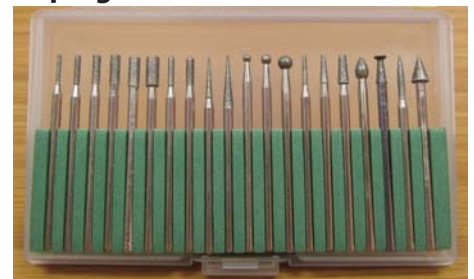

- Ø2.35mm Shank
- Set of 20 Individually Smaller Burrs
- Diamond Engraving
- Best set for medium work pieces, very good variety
- Multi-purpose set comes with a wide variety of burrs

Shapes:

- 6 x Cylinders
- 2 x Parallel Domed End
- 2 x Points
- 3 x Ball
- 3 x Taper Cylinder
- 1 x Bud
- 1 x Inverted Cone
- 1 x Flame
- 1 x Cone

Weight of set D33871: 50grams

Code	Description	UOM	Price
D33871	Regular Size Diamond Impregnated Burr Set	PACK*20	£9.95

**(01) Cylinder**



- Cylinder



• Ø1.1mm x 7.5mm

Code	Description	UOM	Price
D33872	(01) Cylinder	EACH	£1.25

**(02) Cylinder**



• Cylinder  
• Ø1.5mm x 7mm

Code	Description	UOM	Price
D33873	(02) Cylinder	EACH	£1.25

**(03) Cylinder**



• Cylinder  
• Ø2.0mm x 7.5mm

Code	Description	UOM	Price
D33874	(03) Cylinder	EACH	£1.25

**(04) Cylinder**



• Cylinder  
• Ø2.4mm x 7mm

Code	Description	UOM	Price
D33875	(04) Cylinder	EACH	£1.25

**(05) Cylinder**



• Cylinder  
• Ø2.7mm x 7mm

Code	Description	UOM	Price
D33876	(05) Cylinder	EACH	£1.25

**(06) Cylinder**



• Cylinder  
• Ø3.2mm x 7mm

Code	Description	UOM	Price
D33877	(06) Cylinder	EACH	£1.25

**(07) Parallel Domed End**



• Parallel Domed End  
• Ø1.4mm x 7mm

Code	Description	UOM	Price
D33878	(07) Parallel Domed End	EACH	£1.25

**(08) Parallel Domed End**



• Parallel Domed End

• Ø1.9mm x 7mm

Code	Description	UOM	Price
D33879	(08) Parallel Domed End	EACH	£1.25

**(09) Point**



• Point  
• Ø2.0mm x 9.5mm

Code	Description	UOM	Price
D33880	(09) Point	EACH	£1.25

**(10) Point**



• Point  
• Ø2.4mm x 13mm

Code	Description	UOM	Price
D33881	(10) Point	EACH	£1.25

**(11) Ball**



• Ball  
• Ø2.0mm

Code	Description	UOM	Price
D33882	(11) Ball	EACH	£1.25

**(12) Ball**



• Ball  
• Ø2.4mm

Code	Description	UOM	Price
D33883	(12) Ball	EACH	£1.25

**(13) Ball**



• Ball  
• Ø3.5mm

Code	Description	UOM	Price
D33884	(13) Ball	EACH	£1.25

**(14) Taper Cylinder**



• Taper Cylinder  
• Ø1.4mm x 7.5mm

Code	Description	UOM	Price
D33885	(14) Taper Cylinder	EACH	£1.25

**(15) Taper Cylinder**



• Taper Cylinder

• Ø1.9mm x 7mm

Code	Description	UOM	Price
D33886	(15) Taper Cylinder	EACH	£1.25

**(16) Taper Cylinder**



• Taper Cylinder  
• Ø2.7mm x 7mm

Code	Description	UOM	Price
D33887	(16) Taper Cylinder	EACH	£1.25

**(17) Bud**



• Bud  
• Ø4.0mm x 5mm

Code	Description	UOM	Price
D33888	(17) Bud	EACH	£1.25

**(18) Inverted Cone**



• Inverted Cone  
• Ø3.0mm x 7.5mm

Code	Description	UOM	Price
D33889	(18) Inverted Cone	EACH	£1.25

**(19) Flame**



• Flame  
• Ø1.7mm x 10mm

Code	Description	UOM	Price
D33890	(19) Flame	EACH	£1.25

**(20) Cone**



• Cone  
• Ø4.2mm x 6mm

Code	Description	UOM	Price
D33891	(20) Cone	EACH	£1.25

**PRICE PROMISE  
GUARANTEE**

Mounted Roll & Drum Sanders

See Page 1130



***Cousins Assorted Shapes Set, XL***

**Large Diamond Impregnated Burr Set**



- Set of large Diamond Impregnated Burrs
- Ø2.35mm Shank
- 10 Individually Different Burrs
- Diamond Engraving
- Ideal set for larger work pieces remarkable variety
- Each multi-purpose set comes with a wide variety of burrs
- Includes convenient plastic storage case

Shapes:

- (01) Disc
- (02) Barrel
- (03) Cone Large
- (04) Cylinder Plain
- (05) Parallel Twist
- (06) Flame Large
- (07) Flame Medium
- (08) Inverted Cone Small
- (09) Tapered Point Fine
- (10) Ball Small

Weight of set D33860: 50 grams

Code	Description	UOM	Price
D33860	Large Diamond Impregnated Burr Set	PACK*10	£19.95

**(01) Disc**



- Disc
- Ø16.0mm x 0.4mm

Code	Description	UOM	Price
D33861	(01) Disc	EACH	£5.75

**(02) Barrel**



- Barrel
- Ø6mm x 10mm

Code	Description	UOM	Price
D33862	(02) Barrel	EACH	£1.95

**(03) Large Cone**



- Large Cone
- Large Ø3.0mm to Ø6.0mm x 13.5mm

Code	Description	UOM	Price
D33863	(03) Large Cone	EACH	£1.95

**(04) Plain Cylinder**



- Plain Cylinder
- Ø3.0mm x 15mm

Code	Description	UOM	Price
D33864	(04) Plain Cylinder	EACH	£1.75

**(05) Parallel Twist**



- Parallel Twist
- Ø2.5mm x 10mm

Code	Description	UOM	Price
D33865	(05) Parallel Twist	EACH	£1.75

**(06) Large Flame**



- Large Flame
- Ø2.5mm x 10mm

Code	Description	UOM	Price
D33866	(06) Large Flame	EACH	£1.75

**(07) Medium Flame**



- Medium Flame
- Ø2.5mm x 6.5mm

Code	Description	UOM	Price
D33867	(07) Medium Flame	EACH	£1.75

**(08) Small Inverted Cone**



- Small Inverted Cone
- Ø3.0mm x 6.5mm

Code	Description	UOM	Price
D33868	(08) Small Inverted Cone	EACH	£1.75

**(09) Fine Tapered Point**



- Fine Tapered Point
- Ø1.5mm x 10mm

Code	Description	UOM	Price
D33869	(09) Fine Tapered Point	EACH	£1.75

**(10) Small Ball**



- Small Ball
- Ø1.0mm

Code	Description	UOM	Price
D33870	(10) Small Ball	EACH	£1.75

***Value Assorted Shapes Sets***

- Ø2.35mm Shank
- Set of 20 or 30 burrs
- Diamond impregnated
- Best set for medium work pieces, very good variety
- Multi-purpose set comes with a wide variety of burrs
- Includes cylinders, cones, balls and tapers
- Supplied in plastic case

**Diamond Burr Set, Pack\*20**



- Pack\*20

Code	Description	UOM	Price
D39203	Diamond Burr Set, Pack*20	PACK*20	£4.95

**Diamond Burr Set, Pack\*30**



- Pack\*30

Code	Description	UOM	Price
D39024	Diamond Burr Set, Pack*30	PACK*30	£5.95

**Online Discounts**

**Diamond Coated Jewellery Drills**

See Page 834



**Cutting Disk Wheels**

See Page 1129



**STEEL BURRS, A\*F SWISS & BUSCH**



A\*F Swiss Made and Busch (German) embrace exceptional quality and cutting shape edge superiority, expect only the best.

Finest Quality, in hardened alloy steel for reliability, long life and accuracy. Satisfaction guaranteed. Shaft size is a standard diameter of 2.35mm (3/32").

- Some of the popular style stone steel burr shapes are used for setting
- We stock a wide variety of sizes and shapes which cater for all your stone settings needs
- See the associated links for an excellent choice of practical stone setting books and equipment. We also recommend if you have not stone set before attend a course
- Various courses are available around the country at various colleges and universities. Remember practice is essential to become a quality stone setter
- Burrs are also popular for use when engraving, texturing and grinding.
- We have put some popular styles of setting/working practices when they use Cousins Material House steel burrs.

**Ball Burrs:** the most popular steel burrs used in jewellery stone setting, with its all round shape

**Bearing Cutter 90° Burrs:** the angle of this burr reflects the popular cut diamonds' right angle

**Bud tapered burrs:** very popular for forming channel setting grooves, particularly on wedding rings.

**Concave Cutter Cup Burrs:** to round off end points of various sizes of metal, for example on a claw set ring.

**Flame burrs:** very useful to open out casting flash (a slight film of metal over a whole/crevice).

**Knife Edge Cutting Burr:** perfectly textures deep grooves on jewellery.

**Ball (A\*F 119.300) Most Popular**



- A\*F 119.300
- Ø2.35mm Shank
- Most popular
- Coarse serrations

Equivalent:  
 • Busch 1  
 • Maillefer 23

Ball burrs are the most popular steel burrs used in jewellery stone setting, with its all round shape you can open out stone setting mounts accurately and with speed. Use ball drills on round gemstones, particularly ideal for diamond setting. The gemstone culet and girdle sit well within the bored hole ready for the stone to be secured using gravers/burnishers.

Smaller size ball drills are very useful for claw and channel setting, grooving on the prongs is recommended so the girdle slots and ready to push over. When channel setting, groove the side walls ready for the girdle to sit into the setting.

Code	Description	UOM	Price
119300003	Ø0.30mm Burr, A*F Swiss	EACH	£0.78
119300004	Ø0.40mm Burr, A*F Swiss	EACH	£0.78
119300005	Ø0.50mm Burr, A*F Swiss	EACH	£0.65
119300006	Ø0.60mm Burr, A*F Swiss	EACH	£0.65
119300007	Ø0.70mm Burr, A*F Swiss	EACH	£0.65
119300008	Ø0.80mm Burr, A*F Swiss	EACH	£0.65
119300009	Ø0.90mm Burr, A*F Swiss	EACH	£0.65
119300010	Ø1.00mm Burr, A*F Swiss	EACH	£0.65
119300011	Ø1.10mm Burr, A*F Swiss	EACH	£0.65
119300012	Ø1.20mm Burr, A*F Swiss	EACH	£0.65
119300013	Ø1.30mm Burr, A*F Swiss	EACH	£0.65
119300014	Ø1.40mm Burr, A*F Swiss	EACH	£0.65
119300015	Ø1.50mm Burr, A*F Swiss	EACH	£0.65
119300016	Ø1.60mm Burr, A*F Swiss	EACH	£0.65
119300017	Ø1.70mm Burr, A*F Swiss	EACH	£0.65
119300018	Ø1.80mm Burr, A*F Swiss	EACH	£0.65
119300019	Ø1.90mm Burr, A*F Swiss	EACH	£0.65
119300020	Ø2.00mm Burr, A*F Swiss	EACH	£0.65
119300021	Ø2.10mm Burr, A*F Swiss	EACH	£0.65
119300022	Ø2.20mm Burr, A*F Swiss	EACH	£0.65
119300023	Ø2.30mm Burr, A*F Swiss	EACH	£0.65
119300024	Ø2.40mm Burr, A*F Swiss	EACH	£1.35
119300025	Ø2.50mm Burr, A*F Swiss	EACH	£1.35
119300026	Ø2.60mm Burr, A*F Swiss	EACH	£1.35
119300027	Ø2.70mm Burr, A*F Swiss	EACH	£1.35
119300028	Ø2.80mm Burr, A*F Swiss	EACH	£1.35
119300029	Ø2.90mm Burr, A*F Swiss	EACH	£1.35
119300030	Ø3.00mm Burr, A*F Swiss	EACH	£1.55
119300031	Ø3.10mm Burr, A*F Swiss	EACH	£1.55
119300033	Ø3.30mm Burr, A*F Swiss	EACH	£1.55
119300035	Ø3.50mm Burr, A*F Swiss	EACH	£1.55
119300040	Ø4.00mm Burr, A*F Swiss	EACH	£1.55
119300042	Ø4.20mm Burr, A*F Swiss	EACH	£1.55
119300045	Ø4.50mm Burr, A*F Swiss	EACH	£2.75
119300047	Ø4.70mm Burr, A*F Swiss	EACH	£2.75
119300050	Ø5.00mm Burr, A*F Swiss	EACH	£2.75
119300055	Ø5.50mm Burr, A*F Swiss	EACH	£4.50
119300060	Ø6.00mm Burr, A*F Swiss	EACH	£4.50
119300065	Ø6.50mm Burr, A*F Swiss	EACH	£4.50
119300070	Ø7.00mm Burr, A*F Swiss	EACH	£4.50
119300075	Ø7.50mm Burr, A*F Swiss	EACH	£4.50
119300080	Ø8.00mm Burr, A*F Swiss	EACH	£5.95
119300085	Ø8.50mm Burr, A*F Swiss	EACH	£5.95
119300090	Ø9.00mm Burr, A*F Swiss	EACH	£5.95
119300095	Ø9.50mm Burr, A*F Swiss	EACH	£5.95
119300100	Ø10.00mm Burr, A*F Swiss	EACH	£8.95

Price breaks available, see website

**Bearing Cutter 70° Stone Setting (A\*F 119.257S)**



- A\*F Swiss 119.257
- Ø2.35mm Shank
- 70° bearing cutter, Stone Setting
- Popular for stone setting

Equivalent:  
 • Busch 446  
 • Maillefer HB

Code	Description	UOM	Price
1192575005	Ø0.50mm Burr, A*F Swiss	EACH	£1.60
1192575006	Ø0.60mm Burr, A*F Swiss	EACH	£1.60
1192575007	Ø0.70mm Burr, A*F Swiss	EACH	£1.60
1192575008	Ø0.80mm Burr, A*F Swiss	EACH	£1.60
1192575009	Ø0.90mm Burr, A*F Swiss	EACH	£1.60
1192575010	Ø1.00mm Burr, A*F Swiss	EACH	£1.60
1192575011	Ø1.10mm Burr, A*F Swiss	EACH	£1.60
1192575012	Ø1.20mm Burr, A*F Swiss	EACH	£1.60
1192575013	Ø1.30mm Burr, A*F Swiss	EACH	£1.60
1192575014	Ø1.40mm Burr, A*F Swiss	EACH	£1.60
1192575015	Ø1.50mm Burr, A*F Swiss	EACH	£1.60
1192575016	Ø1.60mm Burr, A*F Swiss	EACH	£1.60
1192575017	Ø1.70mm Burr, A*F Swiss	EACH	£1.60
1192575018	Ø1.80mm Burr, A*F Swiss	EACH	£1.60
1192575019	Ø1.90mm Burr, A*F Swiss	EACH	£1.60
1192575020	Ø2.00mm Burr, A*F Swiss	EACH	£2.05
1192575021	Ø2.10mm Burr, A*F Swiss	EACH	£2.05
1192575022	Ø2.20mm Burr, A*F Swiss	EACH	£2.05
1192575023	Ø2.30mm Burr, A*F Swiss	EACH	£2.05
1192575025	Ø2.50mm Burr, A*F Swiss	EACH	£2.75
1192575027	Ø2.70mm Burr, A*F Swiss	EACH	£2.75
1192575029	Ø2.90mm Burr, A*F Swiss	EACH	£2.75
1192575031	Ø3.10mm Burr, A*F Swiss	EACH	£2.75
1192575033	Ø3.30mm Burr, A*F Swiss	EACH	£2.75
1192575035	Ø3.50mm Burr, A*F Swiss	EACH	£2.75
1192575037	Ø3.70mm Burr, A*F Swiss	EACH	£3.95

Price breaks available, see website

**Bearing Cutter 90° Stone Setting (A\*F 119.257)**

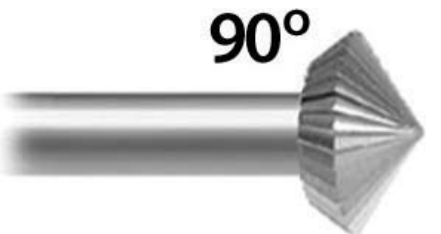

- A\*F Swiss 119.257
- Ø2.35mm Shank
- 90° bearing cutter, Stone Setting
- Popular for stone setting

The bearing cutter is a popular stone setting burr, also known to stone setters as the stone setting burr. Notice the shape is a round diamond with which makes it unique for the higher quality stone settings as the sits perfectly in the setting.

The 90° angle of this burr reflects the popular cut diamonds' right angle. When using this burr the girdle part of the burr will grove excellent results for channel and peg settings. These burrs make setting fast and accurate.

Equivalent:

**Foredom Brushless Micromotor**



**See Page 684**

- Busch 414
- Maillefer HD

Code	Description	UOM	Price
119257005	Ø0.50mm Burr, A*F Swiss	EACH	£1.50
119257006	Ø0.60mm Burr, A*F Swiss	EACH	£1.50
119257007	Ø0.70mm Burr, A*F Swiss	EACH	£1.50
119257008	Ø0.80mm Burr, A*F Swiss	EACH	£1.50
119257009	Ø0.90mm Burr, A*F Swiss	EACH	£1.50
119257010	Ø1.00mm Burr, A*F Swiss	EACH	£1.50
119257011	Ø1.10mm Burr, A*F Swiss	EACH	£1.50
119257012	Ø1.20mm Burr, A*F Swiss	EACH	£1.50
119257013	Ø1.30mm Burr, A*F Swiss	EACH	£1.50
119257014	Ø1.40mm Burr, A*F Swiss	EACH	£1.50
119257015	Ø1.50mm Burr, A*F Swiss	EACH	£1.50
119257016	Ø1.60mm Burr, A*F Swiss	EACH	£1.50
119257017	Ø1.70mm Burr, A*F Swiss	EACH	£1.50
119257018	Ø1.80mm Burr, A*F Swiss	EACH	£1.50
119257019	Ø1.90mm Burr, A*F Swiss	EACH	£1.50
119257020	Ø2.00mm Burr, A*F Swiss	EACH	£1.50
119257021	Ø2.10mm Burr, A*F Swiss	EACH	£1.50
119257022	Ø2.20mm Burr, A*F Swiss	EACH	£1.50
119257023	Ø2.30mm Burr, A*F Swiss	EACH	£1.50
119257024	Ø2.40mm Burr, A*F Swiss	EACH	£2.25
119257025	Ø2.50mm Burr, A*F Swiss	EACH	£2.25
119257026	Ø2.60mm Burr, A*F Swiss	EACH	£2.25
119257027	Ø2.70mm Burr, A*F Swiss	EACH	£2.25
119257028	Ø2.80mm Burr, A*F Swiss	EACH	£2.25
119257029	Ø2.90mm Burr, A*F Swiss	EACH	£2.25
119257030	Ø3.00mm Burr, A*F Swiss	EACH	£2.65
119257031	Ø3.10mm Burr, A*F Swiss	EACH	£2.65
119257033	Ø3.30mm Burr, A*F Swiss	EACH	£2.65
119257035	Ø3.50mm Burr, A*F Swiss	EACH	£2.65
119257037	Ø3.70mm Burr, A*F Swiss	EACH	£2.85
119257040	Ø4.00mm Burr, A*F Swiss	EACH	£2.85
119257042	Ø4.20mm Burr, A*F Swiss	EACH	£2.85
119257045	Ø4.50mm Burr, A*F Swiss	EACH	£2.85
119257047	Ø4.70mm Burr, A*F Swiss	EACH	£2.85
119257050	Ø5.00mm Burr, A*F Swiss	EACH	£3.00

Price breaks available, see website

## Bearing Cutter 120° Stone Setting (A\*F 119.272)

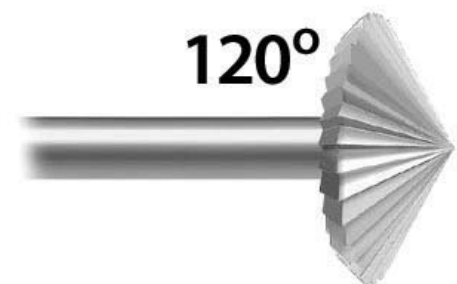

- A\*F Swiss 119.272
- Ø2.35mm Shank
- 120° bearing cutter, Stone Setting
- Fine serrations

Equivalent:  
• Maillefer H

Code	Description	UOM	Price
119272009	Ø0.90mm Burr, A*F Swiss	EACH	£2.10
119272010	Ø1.00mm Burr, A*F Swiss	EACH	£2.10
119272012	Ø1.20mm Burr, A*F Swiss	EACH	£2.10
119272013	Ø1.30mm Burr, A*F Swiss	EACH	£2.10
119272014	Ø1.40mm Burr, A*F Swiss	EACH	£2.10
119272015	Ø1.50mm Burr, A*F Swiss	EACH	£2.10
119272017	Ø1.70mm Burr, A*F Swiss	EACH	£2.10
119272018	Ø1.80mm Burr, A*F Swiss	EACH	£2.10
119272020	Ø2.00mm Burr, A*F Swiss	EACH	£2.10
119272021	Ø2.10mm Burr, A*F Swiss	EACH	£2.10
119272022	Ø2.20mm Burr, A*F Swiss	EACH	£2.10
119272023	Ø2.30mm Burr, A*F Swiss	EACH	£2.10
119272024	Ø2.40mm Burr, A*F Swiss	EACH	£2.95

119272025	Ø2.50mm Burr, A*F Swiss	EACH	£2.95
119272026	Ø2.60mm Burr, A*F Swiss	EACH	£2.95
119272027	Ø2.70mm Burr, A*F Swiss	EACH	£2.95
119272028	Ø2.80mm Burr, A*F Swiss	EACH	£2.95
119272029	Ø2.90mm Burr, A*F Swiss	EACH	£2.95
119272030	Ø3.00mm Burr, A*F Swiss	EACH	£2.95
119272035	Ø3.50mm Burr, A*F Swiss	EACH	£2.95
119272040	Ø4.00mm Burr, A*F Swiss	EACH	£3.95
119272050	Ø5.00mm Burr, A*F Swiss	EACH	£3.95
119272600	Ø6.00mm Burr, A*F Swiss	EACH	£3.95

Price breaks available, see website

## Bud (A\*F 119.262) Popular



- A\*F Swiss 119.262
- Ø2.35mm Shank
- Bud
- Most popular bud shape

Equivalent:  
• Busch 6  
• Maillefer Z

Code	Description	UOM	Price
119262006	Ø0.60mm Burr, A*F Swiss	EACH	£0.80
119262008	Ø0.80mm Burr, A*F Swiss	EACH	£0.80
119262009	Ø0.90mm Burr, A*F Swiss	EACH	£0.80
119262010	Ø1.00mm Burr, A*F Swiss	EACH	£0.80
119262012	Ø1.20mm Burr, A*F Swiss	EACH	£0.80
119262014	Ø1.40mm Burr, A*F Swiss	EACH	£0.80
119262015	Ø1.50mm Burr, A*F Swiss	EACH	£0.80
119262016	Ø1.60mm Burr, A*F Swiss	EACH	£0.80
119262018	Ø1.80mm Burr, A*F Swiss	EACH	£0.80
119262021	Ø2.10mm Burr, A*F Swiss	EACH	£0.80
119262023	Ø2.30mm Burr, A*F Swiss	EACH	£0.80
119262025	Ø2.50mm Burr, A*F Swiss	EACH	£1.50
119262027	Ø2.70mm Burr, A*F Swiss	EACH	£1.50
119262029	Ø2.90mm Burr, A*F Swiss	EACH	£1.50
119262031	Ø3.10mm Burr, A*F Swiss	EACH	£1.50
119262033	Ø3.30mm Burr, A*F Swiss	EACH	£1.50
119262035	Ø3.50mm Burr, A*F Swiss	EACH	£1.50
119262037	Ø3.70mm Burr, A*F Swiss	EACH	£1.50
119262040	Ø4.00mm Burr, A*F Swiss	EACH	£2.60
119262042	Ø4.20mm Burr, A*F Swiss	EACH	£2.75
119262045	Ø4.50mm Burr, A*F Swiss	EACH	£2.75
119262047	Ø4.70mm Burr, A*F Swiss	EACH	£2.75
119262050	Ø5.00mm Burr, A*F Swiss	EACH	£2.75

Price breaks available, see website

## Bud (A\*F 119.294) Fine Serrations



- A\*F Swiss 119.294
- Ø2.35mm Shank
- Bud
- Fine serrations

Code	Description	UOM	Price
119294010	Ø1.00mm Burr, A*F Swiss	EACH	£1.35
119294014	Ø1.40mm Burr, A*F Swiss	EACH	£1.35
119294016	Ø1.60mm Burr, A*F Swiss	EACH	£1.35
119294018	Ø1.80mm Burr, A*F Swiss	EACH	£1.35
119294021	Ø2.10mm Burr, A*F Swiss	EACH	£1.35
119294023	Ø2.30mm Burr, A*F Swiss	EACH	£1.35
119294025	Ø2.50mm Burr, A*F Swiss	EACH	£2.52

Price breaks available, see website

## Bud (A\*F 119.293) Coarse Serrations



- A\*F Swiss 119.293
- Ø2.35mm Shank
- Bud
- Coarse serrations

Equivalent:  
• Maillefer 83

Code	Description	UOM	Price
119293050	Ø5.00mm Burr, A*F Swiss	EACH	£5.25
119293060	Ø6.00mm Burr, A*F Swiss	EACH	£6.20
119293070	Ø7.00mm Burr, A*F Swiss	EACH	£6.20
119293080	Ø8.00mm Burr, A*F Swiss	EACH	£6.20

Price breaks available, see website

## Cone, Inverted (A\*F 119.310) Coarse Serrations, Popular



- A\*F Swiss 119.310
- Ø2.35mm Shank
- Inverted cone
- Coarse serrations
- Very popular

Equivalent:  
• Busch 2  
• Maillefer 24

Code	Description	UOM	Price
119310006	Ø0.60mm Burr, A*F Swiss	EACH	£0.55
119310007	Ø0.70mm Burr, A*F Swiss	EACH	£0.55
119310008	Ø0.80mm Burr, A*F Swiss	EACH	£0.55
119310009	Ø0.90mm Burr, A*F Swiss	EACH	£0.55
119310010	Ø1.00mm Burr, A*F Swiss	EACH	£0.55
119310012	Ø1.20mm Burr, A*F Swiss	EACH	£0.55
119310014	Ø1.40mm Burr, A*F Swiss	EACH	£0.55
119310016	Ø1.60mm Burr, A*F Swiss	EACH	£0.55
119310018	Ø1.80mm Burr, A*F Swiss	EACH	£0.55
119310021	Ø2.10mm Burr, A*F Swiss	EACH	£0.55
119310023	Ø2.30mm Burr, A*F Swiss	EACH	£0.55
119310025	Ø2.50mm Burr, A*F Swiss	EACH	£1.25
119310029	Ø2.90mm Burr, A*F Swiss	EACH	£1.25

Price breaks available, see website

## Cone 30° Stone Setting (A\*F 119.253)



- A\*F Swiss 119.253
- Ø2.35mm Shank
- Cone 30° Stone Setting
- Fine serrations

Equivalent:  
• Maillefer N

Code	Description	UOM	Price
119253010	Ø1.00mm Burr, A*F Swiss	EACH	£2.10
119253015	Ø1.50mm Burr, A*F Swiss	EACH	£2.10
119253020	Ø2.00mm Burr, A*F Swiss	EACH	£2.10
119253025	Ø2.50mm Burr, A*F Swiss	EACH	£2.96
119253030	Ø3.00mm Burr, A*F Swiss	EACH	£2.96

119253035	Ø3.50mm Burr, A*F Swiss	EACH	£2.96
119253040	Ø4.00mm Burr, A*F Swiss	EACH	£4.22
119253050	Ø5.00mm Burr, A*F Swiss	EACH	£4.22
119253060	Ø6.00mm Burr, A*F Swiss	EACH	£4.22
119253070	Ø7.00mm Burr, A*F Swiss	EACH	£5.44
119253080	Ø8.00mm Burr, A*F Swiss	EACH	£5.44
119253090	Ø9.00mm Burr, A*F Swiss	EACH	£8.80
Price breaks available, see website			

**Cone 45° Stone Setting (A\*F 119.280) Medium Serrations**

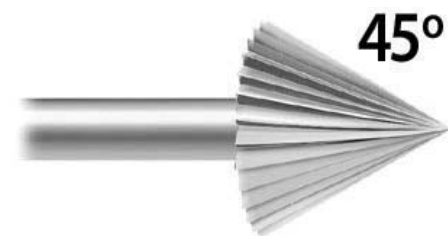

- A\*F Swiss 119.280
- Ø2.35mm Shank
- Cone 45° Stone Setting
- Medium serrations

Equivalent:  
• Maillefer NN

Code	Description	UOM	Price
119280010	Ø1.00mm Burr, A*F Swiss	EACH	£2.10
119280015	Ø1.50mm Burr, A*F Swiss	EACH	£2.10
119280020	Ø2.00mm Burr, A*F Swiss	EACH	£2.10
119280025	Ø2.50mm Burr, A*F Swiss	EACH	£3.20
119280030	Ø3.00mm Burr, A*F Swiss	EACH	£3.20
119280035	Ø3.50mm Burr, A*F Swiss	EACH	£3.20
119280040	Ø4.00mm Burr, A*F Swiss	EACH	£3.50
119280045	Ø4.50mm Burr, A*F Swiss	EACH	£3.50
119280050	Ø5.00mm Burr, A*F Swiss	EACH	£3.50
119280055	Ø5.50mm Burr, A*F Swiss	EACH	£4.95
119280600	Ø60.00mm Burr, A*F Swiss	EACH	£4.95
Price breaks available, see website			

**Cone 45° Stone Setting (A\*F 119.288) Coarse Serrations, Popular**



- A\*F Swiss 119.288
- Ø2.35mm Shank
- Cone 45° Stone Setting
- Coarse serrations
- Very Popular

Equivalent:  
• Busch 5  
• Maillefer NN

Code	Description	UOM	Price
119288008	Ø0.80mm Burr, A*F Swiss	EACH	£0.90
119288010	Ø1.00mm Burr, A*F Swiss	EACH	£0.95
119288012	Ø1.20mm Burr, A*F Swiss	EACH	£0.95
119288015	Ø1.50mm Burr, A*F Swiss	EACH	£0.95
119288016	Ø1.60mm Burr, A*F Swiss	EACH	£0.95
119288018	Ø1.80mm Burr, A*F Swiss	EACH	£0.95
119288020	Ø2.00mm Burr, A*F Swiss	EACH	£1.60
119288025	Ø2.50mm Burr, A*F Swiss	EACH	£1.70
119288030	Ø3.00mm Burr, A*F Swiss	EACH	£2.95
119288040	Ø4.00mm Burr, A*F Swiss	EACH	£2.95
119288050	Ø5.00mm Burr, A*F Swiss	EACH	£2.95
119288080	Ø8.00mm Burr, A*F Swiss	EACH	£4.40
Price breaks available, see website			

**Cone 60° Stone Setting (A\*F 119.282)**

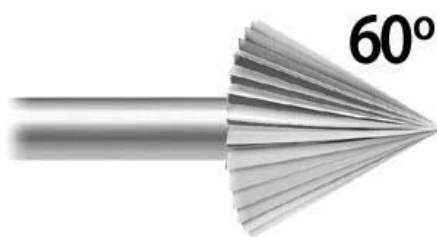

- A\*F Swiss 119.282
- Ø2.35mm Shank
- Cone 60° Stone Setting

Equivalent:  
• Maillefer O

Code	Description	UOM	Price
119282010	Ø1.00mm Burr, A*F Swiss	EACH	£1.65
119282015	Ø1.50mm Burr, A*F Swiss	EACH	£1.65
119282020	Ø2.00mm Burr, A*F Swiss	EACH	£1.65
119282030	Ø3.00mm Burr, A*F Swiss	EACH	£2.35
119282350	Ø3.50mm Burr, A*F Swiss	EACH	£3.85
119282040	Ø4.00mm Burr, A*F Swiss	EACH	£3.85
119282060	Ø6.00mm Burr, A*F Swiss	EACH	£3.95
119282700	Ø7.00mm Burr, A*F Swiss	EACH	£4.50
Price breaks available, see website			

**Cone 90° Stone Setting (A\*F 119.260)**

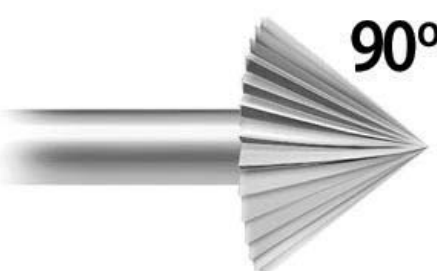

- A\*F Swiss 119.260
- Ø2.35mm Shank
- Cone 90° Stone Setting

Equivalent:  
• Maillefer P

Code	Description	UOM	Price
119260010	Ø1.00mm Burr, A*F Swiss	EACH	£2.20
119260012	Ø1.20mm Burr, A*F Swiss	EACH	£2.20
119260125	Ø1.25mm Burr, A*F Swiss	EACH	£2.20
119260015	Ø1.50mm Burr, A*F Swiss	EACH	£2.20
119260017	Ø1.70mm Burr, A*F Swiss	EACH	£2.20
119260020	Ø2.00mm Burr, A*F Swiss	EACH	£2.20
119260025	Ø2.50mm Burr, A*F Swiss	EACH	£2.75
119260030	Ø3.00mm Burr, A*F Swiss	EACH	£2.75
119260035	Ø3.50mm Burr, A*F Swiss	EACH	£2.75
119260040	Ø4.00mm Burr, A*F Swiss	EACH	£3.90
119260045	Ø4.50mm Burr, A*F Swiss	EACH	£4.05
119260050	Ø5.00mm Burr, A*F Swiss	EACH	£4.05
119260060	Ø6.00mm Burr, A*F Swiss	EACH	£4.60
119260700	Ø7.00mm Burr, A*F Swiss	EACH	£4.60
119260800	Ø8.00mm Burr, A*F Swiss	EACH	£4.60
Price breaks available, see website			

**Cone 90° Stone Setting (A\*F 119.254) with parallel**



- A\*F Swiss 119.254
- Ø2.35mm Shank
- Cone 90° Stone setting
- With Parallel

Equivalent:  
• Busch 413  
• Maillefer Q

Code	Description	UOM	Price
119254009	Ø0.90mm Burr, A*F Swiss	EACH	£1.95
119254010	Ø1.00mm Burr, A*F Swiss	EACH	£1.95
119254011	Ø1.10mm Burr, A*F Swiss	EACH	£1.95
119254012	Ø1.20mm Burr, A*F Swiss	EACH	£1.95
119254013	Ø1.30mm Burr, A*F Swiss	EACH	£1.95
119254014	Ø1.40mm Burr, A*F Swiss	EACH	£1.95
119254015	Ø1.50mm Burr, A*F Swiss	EACH	£1.95
119254016	Ø1.60mm Burr, A*F Swiss	EACH	£1.95
119254017	Ø1.70mm Burr, A*F Swiss	EACH	£1.95
119254018	Ø1.80mm Burr, A*F Swiss	EACH	£1.95
119254019	Ø1.90mm Burr, A*F Swiss	EACH	£1.95
119254020	Ø2.00mm Burr, A*F Swiss	EACH	£1.95
119254021	Ø2.10mm Burr, A*F Swiss	EACH	£1.95
119254022	Ø2.20mm Burr, A*F Swiss	EACH	£1.95
119254023	Ø2.30mm Burr, A*F Swiss	EACH	£1.95
119254024	Ø2.40mm Burr, A*F Swiss	EACH	£2.55
119254025	Ø2.50mm Burr, A*F Swiss	EACH	£2.55
119254027	Ø2.70mm Burr, A*F Swiss	EACH	£2.55
119254029	Ø2.90mm Burr, A*F Swiss	EACH	£2.55
119254030	Ø3.00mm Burr, A*F Swiss	EACH	£2.55
119254031	Ø3.10mm Burr, A*F Swiss	EACH	£2.55
119254033	Ø3.30mm Burr, A*F Swiss	EACH	£2.55
119254035	Ø3.50mm Burr, A*F Swiss	EACH	£2.55
119254037	Ø3.70mm Burr, A*F Swiss	EACH	£3.45
119254040	Ø4.00mm Burr, A*F Swiss	EACH	£3.45
119254042	Ø4.20mm Burr, A*F Swiss	EACH	£3.75
119254045	Ø4.50mm Burr, A*F Swiss	EACH	£3.75
119254047	Ø4.70mm Burr, A*F Swiss	EACH	£3.75
119254050	Ø5.00mm Burr, A*F Swiss	EACH	£3.75
119254060	Ø6.00mm Burr, A*F Swiss	EACH	£4.50
119254650	Ø6.50mm Burr, A*F Swiss	EACH	£4.50
119254070	Ø7.00mm Burr, A*F Swiss	EACH	£4.50
119254080	Ø8.00mm Burr, A*F Swiss	EACH	£4.50
Price breaks available, see website			

**Cup, Concave Cutter (A\*F 119.256)**



- A\*F Swiss 119.256
- Ø2.35mm Shank
- Cup drills
- Concave cutter cup
- Medium serrations

Cup burrs are used to round off end points of various sizes of metal, for example on a claw set ring the end of the claw holding the stone is domed, this has been rounded off with this type of burr.

**Burr Lubricating Wax**



**See Page 800**

This classic claw cluster finisher ensures jewellery will not catch items of clothing when worn. A good example of this is if a customer wears a peg cluster and it has not been finished with a cup burr, when they take off their coat/cardigan it could catch and possibly tear their clothing.

Equivalent:

- Busch 411
- Maillefer S

Code	Description	UOM	Price
119256008	Ø0.80mm Burr, A*F Swiss	EACH	£1.55
119256009	Ø0.90mm Burr, A*F Swiss	EACH	£1.55
119256010	Ø1.00mm Burr, A*F Swiss	EACH	£1.55
119256011	Ø1.10mm Burr, A*F Swiss	EACH	£1.55
119256012	Ø1.20mm Burr, A*F Swiss	EACH	£1.55
119256013	Ø1.30mm Burr, A*F Swiss	EACH	£1.55
119256014	Ø1.40mm Burr, A*F Swiss	EACH	£1.55
119256015	Ø1.50mm Burr, A*F Swiss	EACH	£1.55
119256016	Ø1.60mm Burr, A*F Swiss	EACH	£1.55
119256165	Ø1.65mm Burr, A*F Swiss	EACH	£1.55
119256017	Ø1.70mm Burr, A*F Swiss	EACH	£1.55
119256018	Ø1.80mm Burr, A*F Swiss	EACH	£1.55
119256019	Ø1.90mm Burr, A*F Swiss	EACH	£1.55
119256020	Ø2.00mm Burr, A*F Swiss	EACH	£1.55
119256021	Ø2.10mm Burr, A*F Swiss	EACH	£1.55
119256022	Ø2.20mm Burr, A*F Swiss	EACH	£1.55
119256023	Ø2.30mm Burr, A*F Swiss	EACH	£1.55
119256025	Ø2.50mm Burr, A*F Swiss	EACH	£2.50
119256027	Ø2.70mm Burr, A*F Swiss	EACH	£2.50
119256029	Ø2.90mm Burr, A*F Swiss	EACH	£2.50
119256030	Ø3.00mm Burr, A*F Swiss	EACH	£2.50
119256035	Ø3.50mm Burr, A*F Swiss	EACH	£3.10
119256040	Ø4.00mm Burr, A*F Swiss	EACH	£3.95
119256045	Ø4.50mm Burr, A*F Swiss	EACH	£3.95
119256050	Ø5.00mm Burr, A*F Swiss	EACH	£3.95
119256055	Ø5.50mm Burr, A*F Swiss	EACH	£4.15
119256060	Ø6.00mm Burr, A*F Swiss	EACH	£4.15
119256065	Ø6.50mm Burr, A*F Swiss	EACH	£4.75
119256070	Ø7.00mm Burr, A*F Swiss	EACH	£4.75
119256075	Ø7.50mm Burr, A*F Swiss	EACH	£4.75
119256080	Ø8.00mm Burr, A*F Swiss	EACH	£4.75
119256085	Ø8.50mm Burr, A*F Swiss	EACH	£7.95
119256090	Ø9.00mm Burr, A*F Swiss	EACH	£7.95
119256095	Ø9.50mm Burr, A*F Swiss	EACH	£7.95
119256100	Ø10.00mm Burr, A*F Swiss	EACH	£11.95
Price breaks available, see website			

## Cup, Concave Cutter (A\*F 119.256SC) Super Cut



- A\*F Swiss 119.256SC
- Super Cut
- also known as "S Cut"
- Ø2.35mm Shank
- Cup drills
- Concave cutter cup
- Coarse serrations

Cup burrs are used to round off end points of various sizes of metal, for example on a claw set ring the end of the claw holding the stone is domed, this has been rounded off with this type of burr.

This classic claw cluster finisher ensures jewellery will not catch items of clothing when worn. A good example of this is if a customer wears a peg cluster and it has not been finished with a cup burr, when they take off their coat/cardigan it could catch and possibly tear their clothing.

Equivalent:

• Maillefer S Cut

Code	Description	UOM	Price
119256SC008	Ø0.80mm Burr, A*F Swiss	EACH	£1.75
119256SC009	Ø0.90mm Burr, A*F Swiss	EACH	£1.75
119256SC010	Ø1.00mm Burr, A*F Swiss	EACH	£1.75
119256SC011	Ø1.10mm Burr, A*F Swiss	EACH	£1.75
119256SC012	Ø1.20mm Burr, A*F Swiss	EACH	£1.75
119256SC013	Ø1.30mm Burr, A*F Swiss	EACH	£1.75
119256SC014	Ø1.40mm Burr, A*F Swiss	EACH	£1.75
119256SC015	Ø1.50mm Burr, A*F Swiss	EACH	£1.75
119256SC016	Ø1.60mm Burr, A*F Swiss	EACH	£1.75
119256SC017	Ø1.70mm Burr, A*F Swiss	EACH	£1.75
119256SC018	Ø1.80mm Burr, A*F Swiss	EACH	£1.75
119256SC019	Ø1.90mm Burr, A*F Swiss	EACH	£1.75
119256SC020	Ø2.00mm Burr, A*F Swiss	EACH	£1.75
119256SC021	Ø2.10mm Burr, A*F Swiss	EACH	£1.95
119256SC022	Ø2.20mm Burr, A*F Swiss	EACH	£1.95
119256SC023	Ø2.30mm Burr, A*F Swiss	EACH	£1.95
Price breaks available, see website			

## Cylinder Cross Cut, parallel (A\*F 119.315)



- A\*F Swiss 119.315
- Ø2.35mm Shank
- Cylinder cross cut
- Coarse serrations

Equivalent:

- Maillefer 34

Code	Description	UOM	Price
119315006	Ø0.60mm Burr, A*F Swiss	EACH	£0.90
119315007	Ø0.70mm Burr, A*F Swiss	EACH	£0.90
119315008	Ø0.80mm Burr, A*F Swiss	EACH	£0.90
119315009	Ø0.90mm Burr, A*F Swiss	EACH	£0.90
119315010	Ø1.00mm Burr, A*F Swiss	EACH	£0.90
119315012	Ø1.20mm Burr, A*F Swiss	EACH	£0.90
119315014	Ø1.40mm Burr, A*F Swiss	EACH	£0.90
119315016	Ø1.60mm Burr, A*F Swiss	EACH	£0.90
119315018	Ø1.80mm Burr, A*F Swiss	EACH	£0.90
119315021	Ø2.10mm Burr, A*F Swiss	EACH	£0.95
119315023	Ø2.30mm Burr, A*F Swiss	EACH	£0.88
119315025	Ø2.50mm Burr, A*F Swiss	EACH	£1.84
119315027	Ø2.70mm Burr, A*F Swiss	EACH	£1.84
Price breaks available, see website			

## Cylinder Cross Cut, tapered (A\*F 119.320)



- A\*F Swiss 119.320
- Ø2.35mm Shank
- Cylinder tapered cross cut
- Coarse serrations

Open out holes left over from casting flashing and are popular for engraving name plates.

Equivalent:

- Maillefer 38

Code	Description	UOM	Price
119320006	Ø0.60mm Burr, A*F Swiss	EACH	£0.90
119320007	Ø0.70mm Burr, A*F Swiss	EACH	£0.90
119320008	Ø0.80mm Burr, A*F Swiss	EACH	£0.90
119320009	Ø0.90mm Burr, A*F Swiss	EACH	£0.90
119320010	Ø1.00mm Burr, A*F Swiss	EACH	£0.90
119320011	Ø1.10mm Burr, A*F Swiss	EACH	£0.90
119320012	Ø1.20mm Burr, A*F Swiss	EACH	£0.90
119320013	Ø1.30mm Burr, A*F Swiss	EACH	£0.90
119320014	Ø1.40mm Burr, A*F Swiss	EACH	£0.90
119320015	Ø1.50mm Burr, A*F Swiss	EACH	£0.90

119320016	Ø1.60mm Burr, A*F Swiss	EACH	£0.90
119320018	Ø1.80mm Burr, A*F Swiss	EACH	£0.90
119320021	Ø2.10mm Burr, A*F Swiss	EACH	£0.90
119320023	Ø2.30mm Burr, A*F Swiss	EACH	£0.90
119320025	Ø2.50mm Burr, A*F Swiss	EACH	£1.85
Price breaks available, see website			

## Cylinder Parallel (A\*F 119.255) Fine Serrations

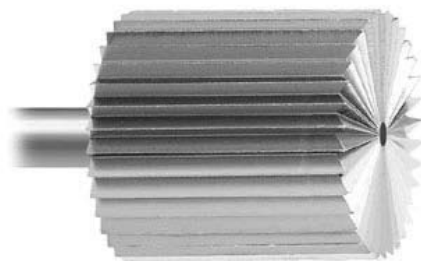

- A\*F Swiss 119.255
- Ø2.35mm Shank
- Cylinder
- Fine serrations

Equivalent:

- Maillefer R

Code	Description	UOM	Price
119255010	Ø1.00mm Burr, A*F Swiss	EACH	£2.10
119255015	Ø1.50mm Burr, A*F Swiss	EACH	£2.10
119255020	Ø2.00mm Burr, A*F Swiss	EACH	£2.10
119255025	Ø2.50mm Burr, A*F Swiss	EACH	£2.65
119255030	Ø3.00mm Burr, A*F Swiss	EACH	£2.65
119255035	Ø3.50mm Burr, A*F Swiss	EACH	£2.65
119255040	Ø4.00mm Burr, A*F Swiss	EACH	£3.15
119255045	Ø4.50mm Burr, A*F Swiss	EACH	£3.75
119255050	Ø5.00mm Burr, A*F Swiss	EACH	£4.00
119255060	Ø6.00mm Burr, A*F Swiss	EACH	£4.37
119255070	Ø7.00mm Burr, A*F Swiss	EACH	£4.95
119255080	Ø8.00mm Burr, A*F Swiss	EACH	£4.95
119255090	Ø9.00mm Burr, A*F Swiss	EACH	£7.96
119255100	Ø10.00mm Burr, A*F Swiss	EACH	£10.25
Price breaks available, see website			

## Cylinder Parallel (A\*F 119.325) Coarse Serrations



- A\*F Swiss 119.325
- Ø2.35mm Shank
- Cylinder parallel
- Coarse serrations

Equivalent:

- Busch 21
- Maillefer 26

Code	Description	UOM	Price
119325007	Ø0.70mm Burr, A*F Swiss	EACH	£0.85
119325008	Ø0.80mm Burr, A*F Swiss	EACH	£0.85
119325009	Ø0.90mm Burr, A*F Swiss	EACH	£0.85
119325010	Ø1.00mm Burr, A*F Swiss	EACH	£0.85
119325012	Ø1.20mm Burr, A*F Swiss	EACH	£0.85
119325014	Ø1.40mm Burr, A*F Swiss	EACH	£0.85
119325016	Ø1.60mm Burr, A*F Swiss	EACH	£0.85
119325018	Ø1.80mm Burr, A*F Swiss	EACH	£0.85
119325021	Ø2.10mm Burr, A*F Swiss	EACH	£0.85
119325023	Ø2.30mm Burr, A*F Swiss	EACH	£0.85
119325025	Ø2.50mm Burr, A*F Swiss	EACH	£1.55
119325027	Ø2.70mm Burr, A*F Swiss	EACH	£1.65
Price breaks available, see website			

**WORLDWIDE DELIVERY**

**Cylinder Parallel (A\*F 119.329) Twisted**



- A\*F Swiss 119.329
- Ø2.35mm Shank
- Cylinder parallel
- Twister serrations

Equivalent:  
• Maillefer 29

Code	Description	UOM	Price
119329007	Ø0.70mm Burr, A*F Swiss	EACH	£0.90
119329008	Ø0.80mm Burr, A*F Swiss	EACH	£0.90
119329009	Ø0.90mm Burr, A*F Swiss	EACH	£0.90
119329010	Ø1.00mm Burr, A*F Swiss	EACH	£0.90
119329012	Ø1.20mm Burr, A*F Swiss	EACH	£0.90
119329014	Ø1.40mm Burr, A*F Swiss	EACH	£0.90
119329016	Ø1.60mm Burr, A*F Swiss	EACH	£0.90
119329018	Ø1.80mm Burr, A*F Swiss	EACH	£0.90
119329021	Ø2.10mm Burr, A*F Swiss	EACH	£0.90
119329023	Ø2.30mm Burr, A*F Swiss	EACH	£0.90
119329025	Ø2.50mm Burr, A*F Swiss	EACH	£1.65
119329027	Ø2.70mm Burr, A*F Swiss	EACH	£1.65

Price breaks available, see website

**Cylinder Rounded (A\*F 119.285) Coarse Serrations**



- A\*F Swiss 119.285
- Ø2.35mm Shank
- Cylinder
- Coarse serrations

Equivalent:  
• Busch 72  
• Maillefer 78

Code	Description	UOM	Price
119285050	Ø5.00mm Burr, A*F Swiss	EACH	£4.15
119285060	Ø6.00mm Burr, A*F Swiss	EACH	£4.15
119285070	Ø7.00mm Burr, A*F Swiss	EACH	£4.95
119285080	Ø8.00mm Burr, A*F Swiss	EACH	£6.50

Price breaks available, see website

**Cylinder Tapered (A\*F 119.330) Coarse Serrations**



- A\*F Swiss 119.330
- Ø2.35mm Shank
- Cylinder tapered
- Coarse serrations

Equivalent:  
• Maillefer 30

Code	Description	UOM	Price
119330009	Ø0.90mm Burr, A*F Swiss	EACH	£0.90
119330010	Ø1.00mm Burr, A*F Swiss	EACH	£0.90
119330012	Ø1.20mm Burr, A*F Swiss	EACH	£0.90
119330014	Ø1.40mm Burr, A*F Swiss	EACH	£0.90
119330016	Ø1.60mm Burr, A*F Swiss	EACH	£0.90
119330018	Ø1.80mm Burr, A*F Swiss	EACH	£0.90
119330021	Ø2.10mm Burr, A*F Swiss	EACH	£0.90
119330023	Ø2.30mm Burr, A*F Swiss	EACH	£0.90

119330025	Ø2.50mm Burr, A*F Swiss	EACH	£1.77
-----------	-------------------------	------	-------

Price breaks available, see website

**Egg (A\*F 119.292)**

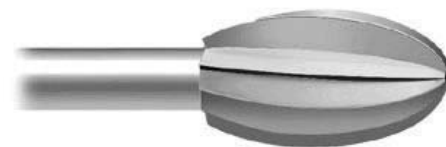

- A\*F Swiss 119.292
- Ø2.35mm shank
- Egg
- Coarse serrations

Equivalent:  
• Maillefer 79

Code	Description	UOM	Price
119292050	Ø5.00mm Burr, A*F Swiss	EACH	£4.85
119292060	Ø6.00mm Burr, A*F Swiss	EACH	£5.70
119292070	Ø7.00mm Burr, A*F Swiss	EACH	£5.70
119292080	Ø8.00mm Burr, A*F Swiss	EACH	£6.65

Price breaks available, see website

**Flame (A\*F 119.286)**



- A\*F Swiss 119.286
- Ø2.35mm shank
- Flame
- Coarse serrations

Flame or Bud tapered burrs are very popular burrs for forming channel setting grooves, particularly on wedding rings. The smaller sizes are ideal to open out holes if you have castings with blocked holes.

Equivalent:  
• Busch 4  
• Maillefer 81

Code	Description	UOM	Price
119286450	Ø4.50mm Burr, A*F Swiss	EACH	£3.95
119286050	Ø5.00mm Burr, A*F Swiss	EACH	£3.95
119286060	Ø6.00mm Burr, A*F Swiss	EACH	£3.95
119286070	Ø7.00mm Burr, A*F Swiss	EACH	£4.95
119286080	Ø8.00mm Burr, A*F Swiss	EACH	£5.55

Price breaks available, see website

**Flame (Busch 4)**



- Busch 4
- 2.35mm shank
- Flame

Flame burrs are very useful to open out casting flash (a slight film of metal over a whole/crevice) as they are finely pointed and get into awkward areas.

Equivalent:  
• A\*F 119.286  
• Maillefer 81

Code	Description	UOM	Price
B008009	Ø0.90mm Burr, Busch	EACH	£0.65
B008010	Ø1.00mm Burr, Busch	EACH	£0.65
B008012	Ø1.20mm Burr, Busch	EACH	£0.65
B008014	Ø1.40mm Burr, Busch	EACH	£0.65
B008016	Ø1.60mm Burr, Busch	EACH	£0.65
B008018	Ø1.80mm Burr, Busch	EACH	£0.65

B008021	Ø2.10mm Burr, Busch	EACH	£0.65
---------	---------------------	------	-------

Price breaks available, see website

**Flame Cross Cut, Krause (A\*F 119.289)**



- A\*F Swiss 119.289
- Ø2.35mm Shank
- Fine flame point
- Cross serrations

Ideal for forming and shaping openings, used for fine detail and cleaning small hard to access places.

Equivalent:  
• Busch 194  
• Maillefer FK

Code	Description	UOM	Price
119289010	Ø1.00mm Burr, A*F Swiss	EACH	£1.95
119289012	Ø1.20mm Burr, A*F Swiss	EACH	£1.95

Price breaks available, see website

**Knife Edge (or Lens) Cutter (A\*F 119.251)**



- A\*F Swiss 119.251
- Ø2.35mm Shank
- Knife edge (or Lens) cutter
- Medium serrations

This Knife Edge Cutting Burr perfectly textures deep grooves on jewellery; this effect looks like the bark of a tree and gives a proud contrast on your piece which will not wear off.

Equivalent:  
• Busch 234  
• Maillefer HH

Code	Description	UOM	Price
119251009	Ø0.90mm Burr, A*F Swiss	EACH	£1.95
119251010	Ø1.00mm Burr, A*F Swiss	EACH	£1.95
119251011	Ø1.10mm Burr, A*F Swiss	EACH	£1.95
119251012	Ø1.20mm Burr, A*F Swiss	EACH	£1.95
119251013	Ø1.30mm Burr, A*F Swiss	EACH	£1.95
119251014	Ø1.40mm Burr, A*F Swiss	EACH	£1.95
119251015	Ø1.50mm Burr, A*F Swiss	EACH	£2.10
119251016	Ø1.60mm Burr, A*F Swiss	EACH	£2.10
119251017	Ø1.70mm Burr, A*F Swiss	EACH	£2.10
119251018	Ø1.80mm Burr, A*F Swiss	EACH	£2.10
119251019	Ø1.90mm Burr, A*F Swiss	EACH	£2.10
119251020	Ø2.00mm Burr, A*F Swiss	EACH	£2.10
119251021	Ø2.10mm Burr, A*F Swiss	EACH	£2.10
119251022	Ø2.20mm Burr, A*F Swiss	EACH	£2.10
119251023	Ø2.30mm Burr, A*F Swiss	EACH	£2.10
119251024	Ø2.40mm Burr, A*F Swiss	EACH	£3.10
119251025	Ø2.50mm Burr, A*F Swiss	EACH	£3.10
119251027	Ø2.70mm Burr, A*F Swiss	EACH	£3.10
119251029	Ø2.90mm Burr, A*F Swiss	EACH	£3.10
119251030	Ø3.00mm Burr, A*F Swiss	EACH	£3.10
119251031	Ø3.10mm Burr, A*F Swiss	EACH	£3.10
119251033	Ø3.30mm Burr, A*F Swiss	EACH	£3.10
119251035	Ø3.50mm Burr, A*F Swiss	EACH	£3.10
119251037	Ø3.70mm Burr, A*F Swiss	EACH	£4.25



119251040	Ø4.00mm Burr, A*F Swiss	EACH	£4.25
119251042	Ø4.20mm Burr, A*F Swiss	EACH	£4.25
119251045	Ø4.50mm Burr, A*F Swiss	EACH	£4.25
119251047	Ø4.70mm Burr, A*F Swiss	EACH	£4.25
119251050	Ø5.00mm Burr, A*F Swiss	EACH	£4.50
119251060	Ø6.00mm Burr, A*F Swiss	EACH	£4.25
119251070	Ø7.00mm Burr, A*F Swiss	EACH	£4.50
119251080	Ø8.00mm Burr, A*F Swiss	EACH	£4.50
119251090	Ø9.00mm Burr, A*F Swiss	EACH	£7.85
119251100	Ø10.00mm Burr, A*F Swiss	EACH	£7.85

Price breaks available, see website

- Ø2.35mm Shank
  - Pear
  - Coarse serrations
- Equivalent:
- Busch 77
  - Maillefer 80

Code	Description	UOM	Price
119290050	Ø5.00mm Burr, A*F Swiss	EACH	£3.39
119290060	Ø6.00mm Burr, A*F Swiss	EACH	£4.14
119290070	Ø7.00mm Burr, A*F Swiss	EACH	£4.89
119290080	Ø8.00mm Burr, A*F Swiss	EACH	£4.89

Price breaks available, see website

## Oval (A\*F 119.278) Medium Serrations



- A\*F Swiss 119.278
- Ø2.35mm Shank
- Oval
- Medium serrations

Equivalent:

- Maillefer Y

Code	Description	UOM	Price
119278010	Ø1.00mm Burr, A*F Swiss	EACH	£2.25
1192780125	Ø1.25mm Burr, A*F Swiss	EACH	£2.25
119278015	Ø1.50mm Burr, A*F Swiss	EACH	£2.25
119278020	Ø2.00mm Burr, A*F Swiss	EACH	£2.60
119278030	Ø3.00mm Burr, A*F Swiss	EACH	£2.95
119278040	Ø4.00mm Burr, A*F Swiss	EACH	£3.95
119278050	Ø5.00mm Burr, A*F Swiss	EACH	£3.95
119278060	Ø6.00mm Burr, A*F Swiss	EACH	£5.70
119278070	Ø7.00mm Burr, A*F Swiss	EACH	£5.70
119278080	Ø8.00mm Burr, A*F Swiss	EACH	£5.70
119278100	Ø10.00mm Burr, A*F Swiss	EACH	£9.95

Price breaks available, see website

## Pear or Long Bud (A\*F 119.291)



- A\*F Swiss 119.291
- Ø2.35mm Shank
- Pear or long bud
- Coarse serrations

Equivalent:

- Busch 79
- Maillefer 82

Code	Description	UOM	Price
119291050	Ø5.00mm Burr, A*F Swiss	EACH	£4.85
119291060	Ø6.00mm Burr, A*F Swiss	EACH	£5.50
119291070	Ø7.00mm Burr, A*F Swiss	EACH	£6.20
119291080	Ø8.00mm Burr, A*F Swiss	EACH	£6.85

Price breaks available, see website

## Round, Fine (A\*F 119.250)

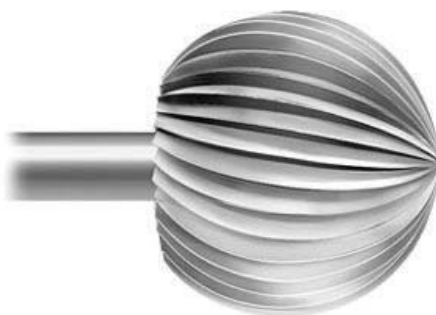

- A\*F Swiss 119.250
- Ø2.35mm Shank
- Round
- Fine serrations

Equivalent:

- Busch 41
- Maillefer A

Code	Description	UOM	Price
119250010	Ø1.00mm Burr, A*F Swiss	EACH	£2.10
119250125	Ø1.25mm Burr, A*F Swiss	EACH	£2.10
119250015	Ø1.50mm Burr, A*F Swiss	EACH	£2.10
119250020	Ø2.00mm Burr, A*F Swiss	EACH	£2.10
119250025	Ø2.50mm Burr, A*F Swiss	EACH	£2.96
119250030	Ø3.00mm Burr, A*F Swiss	EACH	£2.96
119250035	Ø3.50mm Burr, A*F Swiss	EACH	£2.96
119250040	Ø4.00mm Burr, A*F Swiss	EACH	£3.45
119250045	Ø4.50mm Burr, A*F Swiss	EACH	£3.45
119250050	Ø5.00mm Burr, A*F Swiss	EACH	£3.45
119250060	Ø6.00mm Burr, A*F Swiss	EACH	£4.25
119250070	Ø7.00mm Burr, A*F Swiss	EACH	£4.25
119250080	Ø8.00mm Burr, A*F Swiss	EACH	£4.25
119250090	Ø9.00mm Burr, A*F Swiss	EACH	£6.95
119250100	Ø10.00mm Burr, A*F Swiss	EACH	£6.95

Price breaks available, see website

## Round, coarse (A\*F 119.283)



- A\*F Swiss 119.283
- Ø2.35mm Shank
- Round
- Coarse serrations

Code	Description	UOM	Price
119283060	Ø6.00mm Burr, A*F Swiss	EACH	£3.39
119283070	Ø7.00mm Burr, A*F Swiss	EACH	£3.39
119283080	Ø8.00mm Burr, A*F Swiss	EACH	£3.91

Price breaks available, see website

## Round, pearl peg (A\*F 119.263)



- A\*F Swiss 119.263
- Ø2.35mm Shank
- Round with hole
- Fine serrations

This highly specialized ball shape burr has a central hole for producing a stem to fix pearls, plus also to clean the area around the existing peg without damaging it. The profile is the same as a round burr, but with a hole in the centre to create or accommodate the pearl peg.

Code	Description	UOM	Price
119263020	Ø2.00mm Burr, A*F Swiss	EACH	£5.50
119263040	Ø4.00mm Burr, A*F Swiss	EACH	£5.64
119263050	Ø5.00mm Burr, A*F Swiss	EACH	£6.15
119263060	Ø6.00mm Burr, A*F Swiss	EACH	£6.90

Price breaks available, see website

## Oval (A\*F 119.284) Coarse Serrations



- A\*F Swiss 119.284
- Ø2.35mm Shank
- Oval
- Coarse serrations

Equivalent:

- Maillefer 23

Code	Description	UOM	Price
119284050	Ø5.00mm Burr, A*F Swiss	EACH	£4.81
119284060	Ø6.00mm Burr, A*F Swiss	EACH	£4.81
119284070	Ø7.00mm Burr, A*F Swiss	EACH	£6.72
119284080	Ø8.00mm Burr, A*F Swiss	EACH	£6.72

Price breaks available, see website

## Pear (A\*F 119.290)



- A\*F Swiss 119.290

## Wheel (A\*F 119.261) Fine Serrations

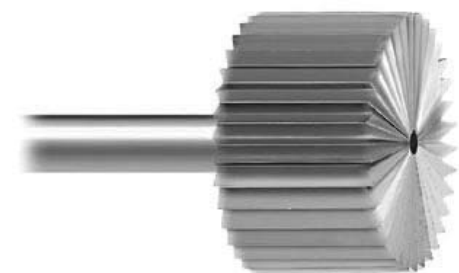

- A\*F Swiss 119.261
- Ø2.35mm Shank
- Wheel
- Fine serrations

Equivalent:

- Maillefer RR

Code	Description	UOM	Price
119261010	Ø1.00mm Burr, A*F Swiss	EACH	£2.20
119261015	Ø1.50mm Burr, A*F Swiss	EACH	£2.20
119261020	Ø2.00mm Burr, A*F Swiss	EACH	£2.20
119261025	Ø2.50mm Burr, A*F Swiss	EACH	£3.10
119261030	Ø3.00mm Burr, A*F Swiss	EACH	£3.10
119261035	Ø3.50mm Burr, A*F Swiss	EACH	£3.10
119261040	Ø4.00mm Burr, A*F Swiss	EACH	£4.10
119261050	Ø5.00mm Burr, A*F Swiss	EACH	£4.10

119261060	Ø6.00mm Burr, A*F Swiss	EACH	£4.10
119261900	Ø90mm Burr, A*F Swiss	EACH	£7.95

Price breaks available, see website

**Wheel (A\*F 119.276)  
Medium Serrations**

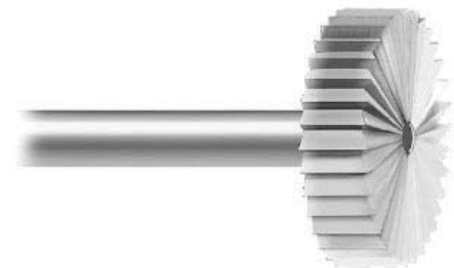

- A\*F Swiss 119.276
- Ø2.35mm Shank
- Wheel
- Medium serrations

Equivalent:  
• Busch 409L  
• Maillefer KK

Code	Description	UOM	Price
119276010	Ø1.00mm Burr, A*F Swiss	EACH	£1.95
119276015	Ø1.50mm Burr, A*F Swiss	EACH	£1.95
119276020	Ø2.00mm Burr, A*F Swiss	EACH	£1.95
119276025	Ø2.50mm Burr, A*F Swiss	EACH	£2.50
119276030	Ø3.00mm Burr, A*F Swiss	EACH	£2.50
119276040	Ø4.00mm Burr, A*F Swiss	EACH	£3.95
119276050	Ø5.00mm Burr, A*F Swiss	EACH	£3.95
119276060	Ø6.00mm Burr, A*F Swiss	EACH	£4.50
119276080	Ø8.00mm Burr, A*F Swiss	EACH	£4.50
119276090	Ø9.00mm Burr, A*F Swiss	EACH	£9.10
119276100	Ø10.00mm Burr, A*F Swiss	EACH	£9.10

Price breaks available, see website

**Wheel (A\*F 119.305)  
Coarse Serrations**



- A\*F Swiss 119.305
- Ø2.35mm Shank
- Wheel
- Coarse serrations

The best burr for channel setting as it can be run in-between the channel, causing a fine groove for setting the diamond girdle.

Equivalent:  
• Busch 3  
• Maillefer 25

Code	Description	UOM	Price
119305006	Ø0.60mm Burr, A*F Swiss	EACH	£0.75
119305007	Ø0.70mm Burr, A*F Swiss	EACH	£0.75
119305008	Ø0.80mm Burr, A*F Swiss	EACH	£0.75
119305009	Ø0.90mm Burr, A*F Swiss	EACH	£0.75
119305010	Ø1.00mm Burr, A*F Swiss	EACH	£0.75
119305012	Ø1.20mm Burr, A*F Swiss	EACH	£0.75
119305014	Ø1.40mm Burr, A*F Swiss	EACH	£0.75
119305016	Ø1.60mm Burr, A*F Swiss	EACH	£0.75
119305018	Ø1.80mm Burr, A*F Swiss	EACH	£0.75
119305021	Ø2.10mm Burr, A*F Swiss	EACH	£0.75
119305023	Ø2.30mm Burr, A*F Swiss	EACH	£0.75
119305025	Ø2.50mm Burr, A*F Swiss	EACH	£1.25
119305027	Ø2.70mm Burr, A*F Swiss	EACH	£1.25
119305029	Ø2.90mm Burr, A*F Swiss	EACH	£1.25

Price breaks available, see website

**Wheel, Cutting Saw (A\*F 119.274) Medium Serrations**

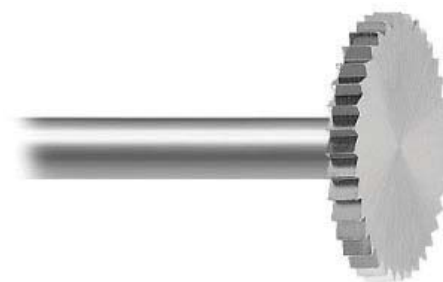

- A\*F Swiss 119.274
- Ø2.35mm shank
- Wheel, cutting saw
- Mounted saw
- Blank Top
- Medium serrations

Equivalent:  
• Maillefer k

Code	Description	UOM	Price
119274010	Ø1.00mm Burr, A*F Swiss	EACH	£2.10
119274015	Ø1.50mm Burr, A*F Swiss	EACH	£2.10
119274020	Ø2.00mm Burr, A*F Swiss	EACH	£2.10
119274025	Ø2.50mm Burr, A*F Swiss	EACH	£2.65
119274030	Ø3.00mm Burr, A*F Swiss	EACH	£2.65
119274035	Ø3.50mm Burr, A*F Swiss	EACH	£2.65
119274040	Ø4.00mm Burr, A*F Swiss	EACH	£3.95
119274050	Ø5.00mm Burr, A*F Swiss	EACH	£3.95
119274060	Ø6.00mm Burr, A*F Swiss	EACH	£4.65
119274070	Ø7.00mm Burr, A*F Swiss	EACH	£4.65
119274080	Ø8.00mm Burr, A*F Swiss	EACH	£4.65
119274090	Ø9.00mm Burr, A*F Swiss	EACH	£7.95
119274100	Ø10.00mm Burr, A*F Swiss	EACH	£11.75

Price breaks available, see website

**Wheel, Cutting Saw (A\*F 119.306) Coarse Serrations**



- A\*F Swiss 119.306
- Ø2.35mm Shank
- Wheel, cutting saw
- Mounted saw
- Blank Top
- Coarse serrations

Equivalent:  
• Maillefer 45

Code	Description	UOM	Price
119306023	Ø2.30mm Burr, A*F Swiss	EACH	£1.30
119306029	Ø2.90mm Burr, A*F Swiss	EACH	£1.75
119306035	Ø3.50mm Burr, A*F Swiss	EACH	£1.85
119306040	Ø4.00mm Burr, A*F Swiss	EACH	£2.60

Price breaks available, see website



**SAME DAY  
DISPATCH**

Deburring Tool

See Page 903



**STEEL BURRS,  
COUSINS EURO**



CousinsUK Burrs

In first quality carbon steel ensuring reliability, long life and accuracy. Satisfaction guaranteed. Shaft size is a standard diameter of 2.35mm (3/32").

- Excellent value
- This range has an excellent cutting pattern for standard cost repair/manufacturing work
- Made from 1st grade quality carbon steel ensuring you long usage
- Available in various shapes and sizes.
- Favourite for the stone setter, engraver, model maker etc.

**Ball (Cousins) Most Popular**



- Ø2.35mm Shank
- Most popular
- Coarse serrations

Equivalent:  
• Busch 1  
• Maillefer 23

Ball burrs are the most popular steel burrs used in jewellery stone setting, with its all round shape you can open out stone setting mounts accurately and with speed. Use ball drills on round gemstones, particularly ideal for diamond setting. The gemstone culet and girdle sit well within the bored hole ready for the stone to be secured using gravers/burnishers.

Smaller size ball drills are very useful for claw and channel setting, grooving on the prongs is recommended so the girdle slots and ready to push over. When channel setting, groove the side walls ready for the girdle to sit into the setting.

Code	Description	UOM	Price
B35762	Ø0.50mm Ball Burr	PACK*6	£2.40
B35763	Ø0.60mm Ball Burr	PACK*6	£2.40
B35764	Ø0.70mm Ball Burr	PACK*6	£2.40
B35765	Ø0.80mm Ball Burr	PACK*6	£2.40
B35766	Ø0.90mm Ball Burr	PACK*6	£2.40
B35767	Ø1.00mm Ball Burr	PACK*6	£2.40
B35768	Ø1.10mm Ball Burr	PACK*6	£2.40
B35769	Ø1.20mm Ball Burr	PACK*6	£2.40
B35770	Ø1.30mm Ball Burr	PACK*6	£2.40
B35771	Ø1.40mm Ball Burr	PACK*6	£2.40
B35772	Ø1.50mm Ball Burr	PACK*6	£2.40
B35773	Ø1.60mm Ball Burr	PACK*6	£2.40
B35774	Ø1.70mm Ball Burr	PACK*6	£2.40
B35775	Ø1.80mm Ball Burr	PACK*6	£2.40
B35776	Ø1.90mm Ball Burr	PACK*6	£2.40
B35777	Ø2.00mm Ball Burr	PACK*6	£2.40
B35778	Ø2.10mm Ball Burr	PACK*6	£2.40
B35779	Ø2.20mm Ball Burr	PACK*6	£2.40
B35780	Ø2.30mm Ball Burr	PACK*6	£2.40

## Bearing Cutter 90° Stone Setting (Cousins)



- Ø2.35mm Shank
- 90° bearing cutter
- Popular for stone setting

The bearing cutter is a popular stone setting burr, also known to stone setters as the stone setting burr. Notice the shape is a round diamond with which makes it unique for the higher quality stone settings as the sits perfectly in the setting.

The 90° angle of this burr reflects the popular cut diamonds' right angle. When using this burr the girdle part of the burr will groove excellent results for channel and peg settings. These burrs make setting fast and accurate.

Equivalent:

- Busch 414
- Maillefer HD

Code	Description	UOM	Price
B35796	Ø0.90mm Stone Setting Burr	PACK*6	£6.60
B35797	Ø1.00mm Stone Setting Burr	PACK*6	£6.60
B35798	Ø1.10mm Stone Setting Burr	PACK*6	£6.60
B35799	Ø1.20mm Stone Setting Burr	PACK*6	£6.60
B35800	Ø1.30mm Stone Setting Burr	PACK*6	£6.60
B35801	Ø1.40mm Stone Setting Burr	PACK*6	£6.60
B35802	Ø1.50mm Stone Setting Burr	PACK*6	£6.60
B35803	Ø1.60mm Stone Setting Burr	PACK*6	£6.60
B35804	Ø1.70mm Stone Setting Burr	PACK*6	£6.60
B35805	Ø1.80mm Stone Setting Burr	PACK*6	£6.60
B35806	Ø1.90mm Stone Setting Burr	PACK*6	£6.60
B35807	Ø2.00mm Stone Setting Burr	PACK*6	£6.60
B35808	Ø2.10mm Stone Setting Burr	PACK*6	£6.60
B35895	Ø2.20mm Stone Setting Burr	PACK*6	£6.60
B35809	Ø2.30mm Stone Setting Burr	PACK*6	£6.60

## Cup, concave cutter (Cousins)



- Ø2.35mm Shank
- Cup drills
- Concave cutter cup

Cup burrs are used to round off end points of various sizes of metal, for example on a claw set ring the end of the claw holding the stone is domed, this has been rounded off with this type of burr. This classic claw cluster finisher ensures jewellery will not catch items of clothing when worn. A good example of this is if a customer is wearing a peg cluster ring which has not been rounded off by a cup burr, it may snag and tear on items of clothing or even catch on doors etc.

Equivalent:

- Busch 411
- Maillefer S

Code	Description	UOM	Price
B35781	Ø0.90mm Cup Burr	PACK*6	£6.50
B35782	Ø1.00mm Cup Burr	PACK*6	£6.50
B35783	Ø1.10mm Cup Burr	PACK*6	£6.50

B35784	Ø1.20mm Cup Burr	PACK*6	£6.50
B35785	Ø1.30mm Cup Burr	PACK*6	£6.50
B35786	Ø1.40mm Cup Burr	PACK*6	£6.50
B35787	Ø1.50mm Cup Burr	PACK*6	£6.50
B35788	Ø1.60mm Cup Burr	PACK*6	£6.50
B35789	Ø1.70mm Cup Burr	PACK*6	£6.50
B35790	Ø1.80mm Cup Burr	PACK*6	£6.50
B35791	Ø1.90mm Cup Burr	PACK*6	£6.50
B35792	Ø2.00mm Cup Burr	PACK*6	£6.50
B35793	Ø2.10mm Cup Burr	PACK*6	£6.50
B35794	Ø2.20mm Cup Burr	PACK*6	£6.50
B35795	Ø2.30mm Cup Burr	PACK*6	£6.60

## Cylinder Cross Cut, tapered (Cousins)



- 2.35mm Shank
- Cylinder tapered cross cut
- Coarse serrations

Open out holes left over from casting flashing and are popular for engraving name plates.

Equivalent:

- Maillefer 38

Code	Description	UOM	Price
B35810	Ø0.60mm Cone Cross Cut	PACK*6	£3.95
B35811	Ø0.70mm Cone Cross Cut	PACK*6	£3.95
B35812	Ø0.80mm Cone Cross Cut	PACK*6	£3.95
B35813	Ø0.90mm Cone Cross Cut	PACK*6	£3.95
B35814	Ø1.00mm Cone Cross Cut	PACK*6	£3.95
B35815	Ø1.10mm Cone Cross Cut	PACK*6	£3.95
B35816	Ø1.20mm Cone Cross Cut	PACK*6	£3.95
B35817	Ø1.40mm Cone Cross Cut	PACK*6	£3.95
B35818	Ø1.50mm Cone Cross Cut	PACK*6	£3.95
B35819	Ø1.60mm Cone Cross Cut	PACK*6	£3.95
B35820	Ø1.80mm Cone Cross Cut	PACK*6	£3.95
B35821	Ø2.00mm Cone Cross Cut	PACK*6	£3.95
B35822	Ø2.10mm Cone Cross Cut	PACK*6	£3.95
B35823	Ø2.30mm Cone Cross Cut	PACK*6	£3.95

## Flame (Cousins)



- Ø2.35mm Shank
- Tapered Flame Burr

Flame or Bud tapered burrs are very popular burrs for forming channel setting grooves, particularly on wedding rings. The smaller sizes are ideal to open out holes if you have castings with blocked holes.

Equivalent:

- Busch 4
- Maillefer 81

Code	Description	UOM	Price
B35837	Ø0.90mm Bud Burr	PACK*6	£2.35
B35838	Ø1.00mm Bud Burr	PACK*6	£2.35
B35840	Ø1.20mm Bud Burr	PACK*6	£2.35
B35841	Ø1.40mm Bud Burr	PACK*6	£2.35
B35842	Ø1.50mm Bud Burr	PACK*6	£2.35
B35843	Ø1.60mm Bud Burr	PACK*6	£2.35
B35844	Ø1.70mm Bud Burr	PACK*6	£2.35
B35845	Ø1.80mm Bud Burr	PACK*6	£2.35
B35846	Ø1.90mm Bud Burr	PACK*6	£2.35
B35847	Ø2.00mm Bud Burr	PACK*6	£2.35
B35848	Ø2.10mm Bud Burr	PACK*6	£2.35
B35849	Ø2.30mm Bud Burr	PACK*6	£2.35

## Wheel (Cousins) Coarse Serrations



- 2.35mm Shank
- Wheel
- Coarse serrations

The best burr for channel setting as it can be run in-between the channel, causing a fine groove for setting the diamond girdle.

Equivalent:

- Busch 3
- Maillefer 25

Code	Description	UOM	Price
B35824	Ø0.60mm Wheel Burr	PACK*6	£2.65
B35825	Ø0.70mm Wheel Burr	PACK*6	£2.65
B35826	Ø0.80mm Wheel Burr	PACK*6	£2.65
B35827	Ø0.90mm Wheel Burr	PACK*6	£2.65
B35828	Ø1.00mm Wheel Burr	PACK*6	£2.65
B35829	Ø1.10mm Wheel Burr	PACK*6	£2.65
B35830	Ø1.20mm Wheel Burr	PACK*6	£2.65
B35831	Ø1.30mm Wheel Burr	PACK*6	£2.65
B35832	Ø1.40mm Wheel Burr	PACK*6	£2.65
B35835	Ø2.20mm Wheel Burr	PACK*6	£2.65
B35836	Ø2.30mm Wheel Burr	PACK*6	£2.65

## STEEL BURRS, SETS

### Popular Shapes, Larger Sizes Ø1.5mm to Ø6mm



A\*F Swiss

Set of 24 fine cut "Swiss Made" burrs, containing 9 of the most popular shapes in diameters Ø1.50mm to Ø6.00mm. All shaft diameters Ø2.35mm. Mounted on a plastic stand for easy selected and storage with a plastic transparent cover.

Set Contains;

- 119.250: (1.5 - 3.0 - 4.5 - 6.0mm) (Maillefer A)
- 119.274: (3.0 - 6.0mm) (Maillefer K)
- 119.253: (3.0 - 4.5 - 5.0mm) (Maillefer N)
- 119.282: (2.0 - 3.0 - 4.0mm) (Maillefer O)
- 119.260: (3.0 - 5.0mm) (Maillefer P)
- 119.254: (3.0 - 4.5 - 6.0mm) (Maillefer Q)
- 119.261: (3.0 - 5.0 - 6.0mm) (Maillefer RR)
- 119.256: (2.0 - 3.0 - 4.5 - 6.0mm) (Maillefer S)

Code	Description	UOM	Price
B47261	Popular Shapes, Larger Sizes Ø1.5mm to Ø6mm	PACK*24	£84.95

**Popular Shapes, Smaller Sizes Ø1mm to Ø2mm**



A\*F Swiss

Set of 24 fine cut "Swiss Made" burrs, containing 12 of the most popular shapes in diameters Ø1.00mm to Ø2.00mm. All shaft diameters Ø2.35mm. Mounted on a plastic stand for easy selected and storage with a plastic transparent cover.

Set Contains;

- 119.250: (1.0 - 1.5 - 2.0mm) (Maillefer A)
- 119.251: (1.0 - 2.0mm) (Maillefer HH)
- 119.274: (2.0mm) (Maillefer K)
- 119.252: (1.0 - 2.1mm) (Maillefer 24)
- 119.280: (2.0mm) (Maillefer NN)
- 119.253: (2.0mm) (Maillefer N)
- 119.260: (1.0 - 1.5 - 2.0mm) (Maillefer P)
- 119.254: (1.0 - 1.5 - 2.0mm) (Maillefer Q)
- 119.261: (2.0mm) (Maillefer RR)
- 119.256: (1.0 - 1.2 - 1.5 - 2.0mm) (Maillefer S)
- 119.278: (2.0mm) (Maillefer Y)
- 119.262: (1.0 - 2.1mm) (Maillefer Z(r))

Code	Description	UOM	Price
B47262	Popular Shapes, Smaller Sizes Ø1mm to Ø2mm	PACK*24	£44.75

**BUSHING TOOLS**

**A\*F Swiss "Screw In" Bushing Tool**



- AF Switzerland 17920.75
- Complete tool with assortment of 75 bushing (B19469)

Instructions For Use

Used for bushing clock main plates without dismantling the movement.

Tool comprises:

- (G) Frame and carriage - No. 17920G
- (P) Pointer - No. 17920P
- (F) Cutter - No. 17920F Ø4.50mm
- (T) Tap - No. 17920T
- (C) Bushing Key - No. 17920C
- (PB) Bushing Holder - No. 17920PB

(M) Handle - No. 17920M

1. Loosen the carriage (G) so that it moves freely on the guide rails of the tool. Fit the tool to the edges of the clock main plate without clamping tightly. (Fig 1)
2. Insert the pointer (P) in the brass guide hole (H) on the carriage and position the tip exactly over the wheel pivot by moving the carriage and the tool. (Fig 2)
3. Fix the carriage by tightening the screw and firmly clamp the complete tool to the edges of the main plate.
4. Remove the pointer and lubricate the guide hole.
5. Fit the hollow cutter (F) to the wooden handle (M) and cut a circular hole around the pivot by pressing and turning the handle. (Fig 3)
6. Remove the cutter and replace with the tap (T) and thread the hole. (Fig 4)
7. Loosen the screws and remove the tool from the plate.
8. Push the wheel pivot up through the hole and select a suitable size bush by holding in the bush holder (PB). If the bush hole needs enlarging this can be done by reaming out while held in the holder. (Fig 5)
9. Screw the bush into position with the key (C). (Fig 6)
10. Lock in the plate by centre popping the plate close to one of the niches. (Fig 7)

Click website "More Information" for full specification.

Code	Description	UOM	Price
B19465	Screw In Bush Clock Bushing Tool	EACH	£295.00
R19477	Tool Cutter Ø4.50mm (F)	EACH	£25.95
R19472	Tool Cutter Ø5.20mm (F1)	EACH	£26.15
K19959	Tool Key (C)	EACH	£18.95
T35882	Tap for Bushing Tool (T)	EACH	£28.95

**Bergeon 16200 Complete Set**



New improved version

- Bushing tool that allows the centring, milling and reaming of clock plates
- Can remove and set brass or bronze bushings (including on very large clocks such as "comtoise" or "Morbier" clocks).
- Black anodized aluminium frame
- Can hold plates from 50 to 220mm
- Practical for all clocks, from mantel clocks to grandfather clocks
- 355 x 355 x 180mm
- Bergeon 16200

Tool includes:

- Complete tool frame
- 10 Reamers: Ø1.27, 1.97, 2.47, 2.97, 3.47, 4.47, 5.47, 6.47, 7.47 & 8.47mm
- 4 Drilled stakes: Ø8 x 3, 10 x 5, 16 x 8 & 30 x 10mm (stake x hole)
- 3 Driving punches: Ø3, 6 & 9mm
- 1 Centring bit
- 2 Centring stakes: Ø16 x 4 & 16 x 9mm (stake x point)
- 1 Undrilled stake: Ø25mm
- 2 Chamfering tools: Ø4 & 10mm
- 5 Pivot cutters: Ø2.20 x 0.40, 3.00 x 0.70, 5.00 x 1.50, 6.00 x 3.00 & 9.00 x 5.00mm (cutter x pivot)
- 1 Jacob chuck: Opening 0 to 4mm

Code	Description	UOM	Price
B0290	Bergeon 16200 Bushing Tool Complete Set	EACH	£945.00

**Bergeon 16200R Reduced Set**



New improved version

- Bushing tool that allows the centring, milling and reaming of clock plates
- Can remove and set brass or bronze bushings (including on very large clocks such as "comtoise" or "Morbier" clocks).
- Black anodized aluminium frame
- Can hold plates from 50 to 220mm
- Practical for all clocks, from mantel clocks to grandfather clocks
- 355 x 355 x 180mm
- Bergeon 16200R

Reduced set, includes:

- Complete tool frame
- 10 Reamers: Ø1.27, 1.97, 2.47, 2.97, 3.47, 4.47, 5.47, 6.47, 7.47 & 8.47mm
- 1 Chamfering tool: Ø4mm
- 4 Drilled stakes: Ø8 x 3, 10 x 5, 16 x 8 & 30 x 10mm (stake x hole)
- 3 Driving punches: Ø3, 6 & 9mm
- 1 Centring bit
- 1 Centring stake: Ø16 x 9mm (stake x point)
- 1 Undrilled stake: Ø25mm

Code	Description	UOM	Price
B0291	Bergeon 16200R Bushing Tool Reduced Set	EACH	£695.00

**Bergeon 6200E Full Accessory Set**



Comprising all components of Bergeon 16200 complete tool (B0290).

Code	Description	UOM	Price
B4929	Bergeon 6200E Bushing Tool Full Accessory Set	EACH	£499.95



**ORDER tracking**

## Centring Bit, Bergeon

- Bergeon 6200.06
- For 16200 & 16200R bushing tools.



Code	Description	UOM	Price
B9560D	Centring Bit For Bergeon Bushing Tool	EACH	£7.25

## Centring Stakes, Bergeon

- Bergeon 6200.12 & 6200.13
- For 16200 & 16200R bushing tools.
- Size given is the point diameter
- Ø16mm stake



Code	Description	UOM	Price
B48324	Ø4.00mm Centring Stake, Bergeon 6200.12	EACH	£25.50
B48325	Ø9.00mm Centring Stake, Bergeon 6200.12	EACH	£18.95

## Cutters (chamfering), Bergeon

Chamfering cutters for 16200 & 16200R bushing tools.



Code	Description	UOM	Price
B0277	Ø4mm Chamfering Bit, 6200.24	EACH	£12.45
B0278	Ø10mm Chamfering Bit, 6200.25	EACH	£17.50

## Cutters (pivot/rose), Bergeon

Pivot/rose cutter for 16200 & 16200R bushing tools.



Code	Description	UOM	Price
B0279	Ø2.20mm Pivot/Rose Cutter 6200.26	EACH	£26.95
B0280	Ø3.00mm Pivot/Rose Cutter 6200.27	EACH	£26.95
B0281	Ø5.00mm Pivot/Rose Cutter 6200.28	EACH	£26.95
B0282	Ø6.00mm Pivot/Rose Cutter 6200.29	EACH	£26.95
B0283	Ø9.00mm Pivot/Rose Cutter 6200.30	EACH	£31.65

Screw In Clock Bushes

See Page 1211



## Driving Punches, Bergeon

Chamfering cutters for Bergeon 16200 and 16200R bushing tools.



Code	Description	UOM	Price
B9560A	Ø3.00mm Driving Punch, Bergeon 6200.03	EACH	£8.95
B9560B	Ø6.00mm Driving Punch, Bergeon 6200.04	EACH	£8.95
B9560C	Ø9.00mm Driving Punch, Bergeon 6200.05	EACH	£8.95

## Jacob's Chuck & Key, Bergeon

- Bergeon 6200.31
- Chamfering cutters for Bergeon 16200 and 16200R bushing tools.



Code	Description	UOM	Price
B0284	Jacob's Chuck & Key For Bergeon Bushing Tool	EACH	£129.95

## Reamers (by size), Bergeon

- Size given is the largest cutting diameters
- Ø1.78 & Ø3.97mm reamers are specifically designed and sized for Morbier and Comtoise clock bushings



Code	Description	UOM	Price
B0267	Ø1.20mm Reamer 6200.14	EACH	£13.50
B0285	Ø1.78mm Reamer 6200.51	EACH	£20.95
B0268	Reamer 6200.15 Ø1.97mm	EACH	£13.50
B0269	Ø2.47mm Reamer 6200.16	EACH	£13.50
B0286	Ø2.68mm Reamer 6200.52	EACH	£20.95
B0270	Ø2.97mm Reamer 6200.17	EACH	£13.50
B0271	Ø3.47mm Reamer 6200.18	EACH	£13.50
B0287	Ø3.97mm Reamer 6200.56	EACH	£20.95
B0272	Ø4.47mm Reamer 6200.19	EACH	£13.50
B0273	Ø5.47mm Reamer 6200.20	EACH	£13.50
B0274	Ø6.47mm Reamer 6200.21	EACH	£13.50
B0275	Ø7.47mm Reamer 6200.22	EACH	£13.50
B0276	Ø8.47mm Reamer 6200.23	EACH	£13.50

## Reamers (sets), Bergeon



- B0288 - K Series Reamers, Bergeon 6200F
- Set of 5 Extra Reamers

- Specific sizes to deal with Bergeon 'K' Range of bushes
- Ø1.78, 2.68, 4.66, 5.85, 8.64mm
- B0289 - Intermediate Reamers, Bergeon 6200G
- Set of 5 Intermediate Reamers
- Specific sizes to deal with larger clocks
- Ø3.97, 4.97, 5.97, 6.97, 7.97mm

Code	Description	UOM	Price
B0288	K Series Reamers, Bergeon 6200F	EACH	£104.65
B0289	Intermediate Reamers, Bergeon 6200G	EACH	£108.95

## Stakes, Bergeon



- Stakes, drilled and undrilled
- For 16200 & 16200R bushing tools
- Bergeon Swiss

Dimensions:

- Stake diameter Ø x hole diameter Ø

Code	Description	UOM	Price
B48327	Undrilled Stake, Bergeon 6200.07	EACH	£10.50
B48328	Ø8 x 3mm Stake, Bergeon 6200.08	EACH	£12.50
B48329	Ø10 x 5mm Stake, Bergeon 6200.09	EACH	£10.50
B48330	Ø16 x 8mm Stake, Bergeon 6200.10	EACH	£10.50
B48331	Ø30 x 10mm Stake, Bergeon 6200.11	EACH	£13.95

# CANNON PINION TOOLS

## Cannon Pinion Remover



Cannon Pinion Remover

- Bergeon 4854
- With lever and wooden handle
- For small and large watches
- Adapted to all calibres
- To operate, the lever must always be pushed down
- To take apart the tool for cleaning, simply lift the handle up
- Length 130mm
- For further information please see the PDF available

Code	Description	UOM	Price
C0296	Cannon Pinion Remover, Bergeon	EACH	£63.50

Cannon Pinion & Pocket Watch Hand Remover

See Page 1095



**Cannon Pinion Tightening Tool, Bergeon 4733**



Cannon Pinion Tightening Tool - Bergeon 4733

- Bergeon 4733
- Cannon pinion tightening tool
- Regulated opening system
- Overall length 120mm

Code	Description	UOM	Price
T26446	Cannon Pinion Tightener, Bergeon 4733	EACH	£66.95

**Cannon Pinion Tightening Tool, Bergeon 31001**

Cannon Pinion Tightening Tool - Bergeon 31001

- Bergeon 31001
- for use with Bergeon jewellery kit
- Cannon pinion tightening tool
- Items available as a set under item code: C4270



Fit the special punch to the spindle and the special stake to the platform of the jewellery tool. The blades must be exactly opposite each other and the micrometer screw must be set before the work is started.

Items available individually under item codes: J30587 & J30588

Code	Description	UOM	Price
C4270	Cannon Pinion Tightening Tool, Bergeon	PACK*2	£18.50

**Centre Nut Fixing Tool, Adjustable**



- Centre nut fixing tool
- Butterfly type
- 2 different types of tips
- Capacity 0 to 40mm
- Adjustable with locking mechanism
- For right or left hand
- Stainless Steel
- Inexpensive to replace if lost
- Tool can be filed to fit as required

Code	Description	UOM	Price
C39633	Centre Nut Fixing Tool, Adjustable	EACH	£2.95

**Centre Nut Fixing Tool with Plastic Handle**



- Good grip
- Length 135mm
- Handle Grip Ø25mm
- Tool can be filed to fit as required

Code	Description	UOM	Price
S32056	Centre Nut Fixing Tool with Plastic Handle	EACH	£1.75

**Centre Nut Fixing Tool with Multiple Ends**



- 4 different size ends
- 75 x 75mm
- Sturdy handheld design
- Tool can be filed to fit as required

Code	Description	UOM	Price
K31257	Centre Nut Fixing Tool with Multiple Ends	EACH	£4.25

**CLOTHS & GLOVES, POLISHING**

**POLISHING CLOTHS**



Worlds favourite Selvyt Cloths

From Victorian housekeepers polishing the family silver to present day high technology plasma lens polishing, Selvyt has been globally recognised as the leading brand of polishing cloth.

The Selvyt family of polishing and impregnated cleaning cloths are used by many exclusive brands in a variety of markets, from Rolex watches to Waterford Crystal, Holland and Holland guns to the British Army for boot polishing, Bausch & Lomb contact lenses to Silstar silverware.

For well over 100 years SELVYT has been the world's leading brand in polishing cloths for the jewellery, watch making and silversmiths trade. Used by the finest craftsmen it has become the benchmark by which all other products are judged.

Manufactured in the U.K. SELVYT is a division of Edmund Bell Ltd a British textile company established in the 19th century, so quality and tradition is guaranteed

Which Selvyt is right for you ?

**Anti-Static, Bergeon**



Bergeon 6032

For synthetic materials sensitive to static electricity, including

- Watch glasses
- Bakelite pieces
- Glass, etc.
- Size: 230 x 300 mm

Code	Description	UOM	Price
P1352	Polishing "Anti-Static" Cloth - Bergeon 6032	EACH	£3.45

**CENTRE NUT TOOLS**

**Centre Nut Fixing Tools**

- For Quartz Clock Movements
- Very effective tools to loosen & tighten the centre mounting nuts on quartz and other battery clock movements
- Tools can be and may need to be filed & modified to fit the varying different makes of quartz clock movements
- See website "more info" for further specifications



**Cotton, Bergeon**



- Bergeon 6719
- Impregnated cloth in pure cotton
- Dimensions: 300 x 190 mm

To polish gold, silver & tin etc. A non-toxic and long lasting impregnation with an anti-oxydant layer. Do not wash

Code	Description	UOM	Price
P1351	Polishing "Cotton" Cloth - Bergeon 6719	EACH	£5.25

**Selvyt 'JC' for Jewellery & Watches**

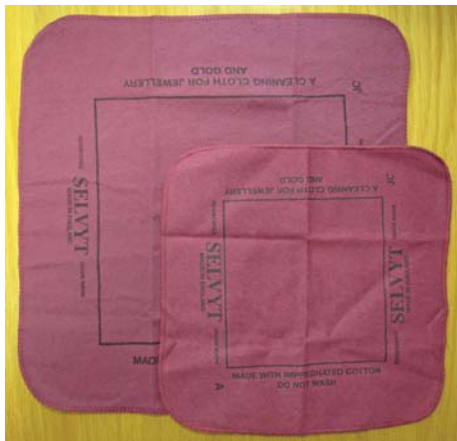

Use a Selvyt JC impregnated cloth to remove the dirt and grime from the item then give the piece a final polish with a Selvyt SR or Selvyt PR cloth. This will have your precious items looking just like new

Impregnated Jewellery Cleaning Cloths are ideal for cleaning small items of gold and platinum jewellery. Manufactured with impregnated 100% cotton. Washing reduces efficiency of impregnation.

Research lead impregnation techniques at Selvyt has produced this advanced product and great all rounder for reviving items back to highest levels of brilliance.

- All jewellery & watches
- Precious metals
- Most decoratively plated items

Code	Description	UOM	Price
P9725	Size A (25 x 25cm) Selvyt 'JC'	EACH	£2.35
P9726	Size B (35 x 35cm) Selvyt 'JC'	EACH	£3.25

Price breaks available, see website



**Latex Disposable Gloves**

See Page 722



**Selvyt 'SC' for Silver**

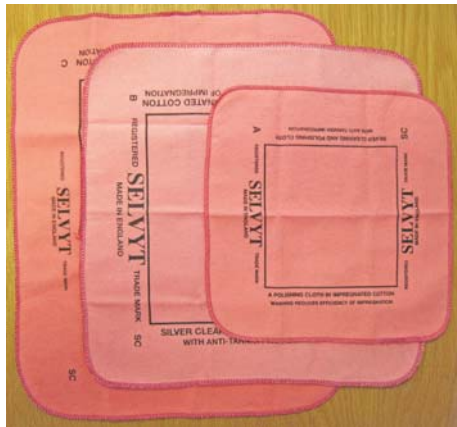

Use the "SC" range for the cleaning operation for Silver. This cloth contains an anti-tarnish ingredient which keeps the silver sparkling. Finish off with a Selvyt SR or Selvyt PR polishing cloth.

Impregnated Silver Cleaning cloth ideal for cleaning dirty and tarnished silver jewellery and silverware. Manufactured with impregnated 100% cotton with an anti-tarnishing agent.

Washing reduces efficiency of impregnation.

Code	Description	UOM	Price
P9697	Size A (25 x 25cm) Selvyt 'SC'	EACH	£1.95
P9698	Size B (35 x 35cm) Selvyt 'SC'	EACH	£2.95
P34453	Size D (52 x 42cm) Selvyt 'SC'	EACH	£4.95
P34454	Size E (52 x 50cm) Selvyt 'SC'	EACH	£5.95

Price breaks available, see website

**Selvyt 'MF' for Spectacles, Laptops & TV Screens**

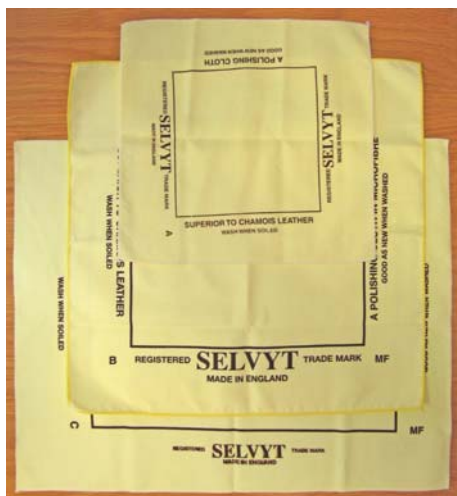

Microfibre Cloth

Top of the range woven microfibre polishing cloth ideal for spectacles, laptop and TV screens. Manufactured in woven polyester microfibre with soft fibres to give smear free finish to lenses and screens.

Good as "New" when washed.

A high tech woven micro-fibre soft feel cloth for optimum smear-free cleaning of polished items (washable).

- Jewellery
- Soft stones
- Glassware and lenses

Code	Description	UOM	Price
P9727	Mini (12.5 x 12.5cm) Selvyt 'MF'	PACK*10	£5.95
P9693	Size A (25 x 25cm) Selvyt 'MF'	EACH	£2.15
P9694	Size B (35 x 35cm) Selvyt 'MF'	EACH	£3.25

Price breaks available, see website

**Selvyt "SR" Traditional**



The Traditional Selvyt "SR" Polishing Cloth - A tried and tested brand in the trade.

Superior to chamois leather, universal multipurpose polishing cloth. Manufactured in woven unbleached cotton with a raised surface to lift particles to leave a perfect finish.

Good as "New" when washed.

Use Selvyt SR cloths for all general polishing jobs. Also ideal for windows, mirrors, wooden and plastic surfaces.

Code	Description	UOM	Price
P6521	Size A (25 x 25cm) Selvyt 'SR'	EACH	£2.35
P6522	Size B (35 x 35cm) Selvyt 'SR'	EACH	£2.85
P6523	Size C (35 x 42cm) Selvyt 'SR'	EACH	£3.95
P6524	Size D (52 x 42cm) Selvyt 'SR'	EACH	£6.50
P6525	Size E (52 x 50cm) Selvyt 'SR'	EACH	£7.50

Price breaks available, see website

**Selvyt 'PR' (Medium Weight)**



Professional medium weight grade polishing cloth, with close weave of 6.5oz per sq yard structure and enhanced texture over SR range.

Top of the range medium weight cloth for polishing larger items such as silverware and guns. Manufactured in woven cotton velvet with a raised surface to lift particles to leave a perfect finish. Good as "New" when washed.

Code	Description	UOM	Price
P12191	Size A (25 x 25cm) Selvyt 'PR'	EACH	£3.15
P12192	Size B (35 x 35cm) Selvyt 'PR'	EACH	£4.15
P12193	Size C (35 x 42cm) Selvyt 'PR'	EACH	£4.75

Price breaks available, see website

**Jewellers Rouge Powder**  
See Page 1172

Selvyt 'PR' (Heavy Weight)

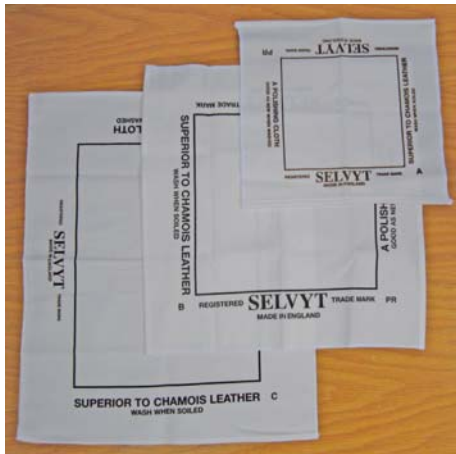

Professional heavyweight grade polishing cloth, with very close weave of 8.5oz per sq yard and enhanced texture over SR range.

Top of the range heavier weight cloth for polishing larger items such as silverware and guns. Manufactured in woven cotton velvet with a raised surface to lift particles to leave a perfect finish. Good as "New" when washed.

Code	Description	UOM	Price
P12194	Size A (25 x 25cm) Selvyt 'PR' - Heavy	EACH	£4.50
P12195	Size B (35 x 35cm) Selvyt 'PR' - Heavy	EACH	£5.95
P12196	Size C (35 x 42cm) Selvyt 'PR' - Heavy	EACH	£6.95

Price breaks available, see website

POLISHING GLOVES

Polishing Gloves

Click below and see our range of Polishing Gloves

For you and your staff, always wear Polishing Gloves when handling jewellery to keep valuables and stock looking new.

- A retail/manufacturing must maintaining high standards
- No more fingerprint marks on stock maintaining that brand new look on watches, jewellery, trays etc.
- Simply hold the item and rub over with your hands with the gloves of your choice and bring the shine back.
- Keep your hands clean when you are handling cleaning fluids
- Use when packing jewellery for mail order to customers, particularly if you have plated the item.
- We stock universal mitt sizes and ladies and gentlemen's sizes in gloves.

Cotton Gloves



- Avoid finger acid staining when handling polished work

• Packs of 10 pairs per size

Code	Description	UOM	Price
G5324	Gloves Cotton, Ladies (Medium)	10 PAIR	£7.95
G5325	Gloves Cotton, Gents	10 PAIR	£7.95

Cotton Gloves, Bergeon



- Bergeon 6718
- Per pair
- Pure Cotton
- To polish gold, silver, tin etc.
- A non toxic and long lasting impregnation with anti-oxidant layer.

Code	Description	UOM	Price
P1350	Gloves Cotton, Bergeon 6718	PAIR	£23.75

COMPASS

Compasses can be used for testing whether or not an object, for example a watch, is magnetised. An object is magnetized when one end of the compass needle is attracted to the item and the other repelled.

Compass

- Ø40mm
- Black plastic base
- Clear plastic top
- Detects magnetism
- Made in India



Code	Description	UOM	Price
S39280	Compass	EACH	£1.25

Compass, Bergeon

Bergeon 30103 - Swiss Made

- Jewelled model sapphire on hardened steel point, chromium plated brass
- Precision compass
- Engraved 13mm dial
- Compass with stylish black wooden case
- Detects magnetism
- Overall size 40 x 40 x 20mm
- Bergeon Swiss



Code	Description	UOM	Price
C0393	Compass - Bergeon 30103	EACH	£42.50

COPPER BOWLS & PANS

Copper Bowls & Pans



- A traditional and popular apparatus to warm up pickling (P5231) and sulphuric acids (C19893)
- Do not react with acid
- No risk of discolouration orf contamination
- Made in UK

Ø100mm Copper Bowl



- Soldering & cleaning bowl
- Ø100mm (4")
- 35mm Depth
- 160gms

Code	Description	UOM	Price
B31898	Ø100mm Copper Bowl	EACH	£10.95

Ø150mm (6") Copper Pan



- 665gms

Code	Description	UOM	Price
P5094	Ø150mm (6") Copper Pan	EACH	£39.95

Ø200mm (8") Copper Pan



- 1170gms

Code	Description	UOM	Price
P5095	Ø200mm (8") Copper Pan	EACH	£44.95

Pickelex Pickle Baths

See Page 704



Pickle Acid Cleaning Salts

See Page 1191





# COUNTERSINKS & PIVOT CUTTERS

## Countersinks, A\*F Swiss



A\*F Swiss

Individually or a set of six double-ended wheel-type countersinks (roller sinkers) in steel with knurled grip. For creating the semi circular half sphere shaped oil sinks in newly inserted clock bushes etc.

6 Sizes:

- Ø1.80 / 2.10mm
- Ø2.50 / 2.80mm
- Ø3.00 / 3.30mm
- Ø3.50 / 3.80mm
- Ø4.00 / 4.30mm
- Ø4.50 / 5.00mm

Code	Description	UOM	Price
C47534	Countersinks Set	PACK*6	£59.95
C47535	Ø1.80 & Ø2.10mm Countersink	EACH	£10.75
C47536	Ø2.50 & Ø2.80mm Countersink	EACH	£10.75
C47537	Ø3.00 & Ø3.30mm Countersink	EACH	£10.75
C47538	Ø3.30 & Ø3.80mm Countersink	EACH	£10.75
C47539	Ø4.00 & Ø4.30mm Countersink	EACH	£10.75
C47540	Ø4.50 & Ø5.00mm Countersink	EACH	£10.75

## Countersinks, Bergeon



Bergeon 1897

Individually or a set of six double-ended wheel-type countersinks (roller sinkers) in steel with knurled grip. For creating the semi circular half sphere shaped oil sinks in newly inserted clock bushes etc.

Set of 6 Sizes:

- Ø1.80 / 2.10mm
- Ø2.50 / 2.80mm
- Ø3.00 / 3.30mm
- Ø3.50 / 3.80mm
- Ø4.00 / 4.30mm
- Ø4.50 / 5.00mm

Code	Description	UOM	Price
C0394	Countersinks - Bergeon 1897	PACK*6	£62.95

## End Mills (Pivot & Screw Cutters), Bergeon 30414



- Double ended cutters
- Perfect for enlarging holes, cleaning screw heads, clearing dial feet and bevelling
- Pack\*6
- Supplied in wooden case
- Bergeon 30414

Set contains:

- Double-ended conical cutter Ø3.00mm & Ø4.50mm
- Double-ended bevelling cutters Ø3.00mm & Ø4.00mm
- Double-ended bevelling cutter Ø1.00mm & Ø2.00mm
- Double-ended cutter to trim screw ends Ø2.50mm & Ø4.00mm
- Double-ended cutter to trim screw ends Ø0.90mm & Ø1.30mm
- Double-ended burr remover, 4 cutting edges with hollow centre. Ø3.00mm x Ø0.65 mm & Ø4.00 x Ø0.90mm (external diameter x hole diameter)

Code	Description	UOM	Price
C48923	Double Ended Pivot Cutters	PACK*6	£179.95

## End Mills (Pivot & Screw Cutters), Bergeon 30007-MD



Assortment of 12 end-mill pivot and screw cutters in hard metal with pivots.

The pivots work as a guide in the hole and the end mills trim the desired part. The pivots are interchangeable with every end mill. It can be used by hand or on a press.

- Bergeon 30007-MD
- Supplied in a Wooden Case
- 12 cutters
- 12 Pivots
- Fixing Sleeves
- Broach
- Hard metal alloy, 90% tungsten with titanium & cobalt

Cutters:

- Ø1.30, 1.60, 1.90, 2.20, 2.50, 2.80mm
- Ø3.10, 3.40, 3.70, 4.00, 4.30, 4.50mm

Pivots:

- Ø0.60mm x 4
- Ø0.70, 0.80, 0.90, 1.00mm
- Ø1.10, 1.20, 1.30, 1.50mm

Code	Description	UOM	Price
C20881	End Mills (Pivot & Screw Cutters) Set, Bergeon 30007.MD	EACH	£1,025.00
C22325	End Mill Ø1.30mm	EACH	£114.95
C22326	End Mill Ø1.60mm	EACH	£114.95
C31430	End Mill Ø1.90mm	EACH	£137.50

C31431	End Mill Ø2.20mm	EACH	£116.50
C31432	End Mill Ø2.50mm	EACH	£116.50
C31433	End Mill Ø2.80mm	EACH	£116.50
C31434	End Mill Ø3.10mm	EACH	£116.50
C31435	End Mill Ø3.40mm	EACH	£116.50
C31436	End Mill Ø3.70mm	EACH	£116.50
C31437	End Mill Ø4.00mm	EACH	£116.50
C31438	End Mill Ø4.30mm	EACH	£116.50
C31439	End Mill Ø4.50mm	EACH	£116.50
C40939	Pivot Ø0.40mm	EACH	£55.95
C40940	Pivot Ø0.45mm	EACH	£55.95
C40941	Pivot Ø0.50mm	EACH	£55.95
C40942	Pivot Ø0.60mm	EACH	£49.95
C40943	Pivot Ø0.70mm	EACH	£49.95
C40944	Pivot Ø0.80mm	EACH	£49.95
C40945	Pivot Ø0.90mm	EACH	£49.95
C40946	Pivot Ø1.00mm	EACH	£49.95
C40947	Pivot Ø1.10mm	EACH	£49.95
C40948	Pivot Ø1.20mm	EACH	£49.95
C40949	Pivot Ø1.30mm	EACH	£49.95
C40950	Pivot Ø1.50mm	EACH	£49.95

# CROWS FOOT

## Crows Foot



A "must" for all clock repairers

- Fits into a vice or bench block, handy for removing all friction wheels & gears
- Oxidation resistant steel
- Weight 145g

Code	Description	UOM	Price
C31268	Clock Crows Foot	EACH	£6.95

# CUTTERS, GUILLOTINES & SHEARS

CousinsUK have a huge selection of hand cutting tools in stock for every workshop and any task. We stock numerous different types and from all over the world, from your hobbyist pair to your top end professional, we have it catered for. The types of cutters we have available offer unsurpassed cutting capacity covering a wide range of wire dimensions and types.

Cutting styles and wire ends:

Bevelled:

- Leaving a standard rise of metal on your wire is acceptable and indeed required in some particular jewellery/component casting or manufacturing
- Bevel cutters require more cutting force and are therefore very durable

- They leave a large pinch on wire ends
- Semi flush, bevelled cutter
- Slight bevel edge to cut thicker wire and leads
- A fine nip would be left in the middle after the item has been cut
- Semi flush cutters require less force and leave a small pinch
- Super flush cutter
- A precise thin bevel which leaves a unique small nip in the middle of the item being cut
- Super flush cutters require minimal cutting force and leave almost no pinch
- Full flush cutter
- No nip cutters, perform like two razor blades coming together
- Full flush cutters require the least amount of force and leave no pinch on wire ends

**Accu-Shear Cutters**



- Create a true flush cut with the Accu-Shear cutters!
- Gives a true shear cut, no waste with your material
  - Leaves end truly flush
  - No need for filing
  - Cut wire up to 6 gauge (4mm)
  - Supplied with stop to allow multiple lengths of wire to be cut accurately
  - With flat nose jaws
  - PVC coated handles
  - Overall length: 200mm
  - Cousins Swiss style
  - Superb Swiss style quality

Code	Description	UOM	Price
P48611	Accu-Shear Cutters	EACH	£19.95

**Diagonal or Side Cutters**

Super Flush Cut: Our large range sourced from all over the world, able to tackle all major workshop metal cutting and precision work.

- For cutting wire or small pieces of sheet metal
- The most commonly used cutter
- The tapered ends allow the cutter to get into tight areas
- Cutters are industry standard and are not suitable for cutting stainless steel
- Value cutters are only suitable for cutting material like solder, rubber, leather etc.

Please be advised that cutters are not guaranteed against breakage or damage



**A\*F Swiss (115mm)**



A\*F Swiss Superior quality cutters in polished steel with box joint. Blue plastic handles with double leaf springs.

- Side Cutters
- Length 115mm

Code	Description	UOM	Price
C47349	A*F Swiss (115mm)	EACH	£24.35

**A\*F Swiss (115mm) Smart Grip**



A\*F Swiss Superb quality cutters with comfortable "Smart Grip" blue and black handles.

- Side Cutters
- Length 115mm

Code	Description	UOM	Price
C47339	A*F Swiss (115mm) Smart Grip	EACH	£21.15

**A\*F Swiss (130mm)**



A\*F Swiss Superior quality cutters in polished steel with box joint. Blue plastic handles with double leaf springs.

- Side Cutters
- Length 130mm

Code	Description	UOM	Price
C47356	A*F Swiss (130mm)	EACH	£24.95

**A\*F Swiss (130mm) Heavy Duty**



A\*F Swiss Heavy duty cutter specially designed for cutting hard and piano wire. Fine quality in polished in polished steel with lap joint.

- Side Cutters
- Heavy Duty (Lap Joint)
- Length 130mm

Code	Description	UOM	Price
C47361	A*F Swiss (130mm) Heavy Duty	EACH	£19.95

**A\*F Swiss (130mm) Smart Grip**



A\*F Swiss Superb quality cutters with comfortable "Smart Grip" blue and black handles.

- Side Cutters
- Length 130mm

Code	Description	UOM	Price
C47338	A*F Swiss (130mm) Smart Grip	EACH	£24.95

**Bergeon (130mm)**



- Bergeon 2629
- Rounded tips
- Length 130mm

Code	Description	UOM	Price
P1251	Bergeon (130mm)	EACH	£37.95

**Cousins Swiss Style (130mm)**



Cousins Swiss Style  
Superior Swiss quality cutters in polished steel with box joint. Blue plastic handles with double leaf springs.

- Side Cutters
- Length 130mm
- Spring loaded (double leaf springs)

Code	Description	UOM	Price
C48568	Cousins Swiss Style (130mm)	EACH	£12.95

**Cousins Swiss Style (130mm) Smart Grip**



Cousins Swiss Style  
Superb Swiss quality cutters with comfortable "Smart Grip" blue and black handles.

- Side Cutters
- Length 130mm
- Spring loaded (double leaf springs)

Code	Description	UOM	Price
C48561	Cousins Swiss Style (130mm) Smart Grip	EACH	£12.95

**Faithfull (180mm) Heavy Duty**



including Piano Wire.  
Faithfull Tools are made to user standards by

craftspeople who meet the demanding Faithfull criteria for the design and quality of each individual item.

- Heavily insulated, soft, comfortable hand grip with slip guards
- Cutting edges are hardened to 64HRC suitable for cutting some metals like piano wire, gold, silver, platinum, palladium, copper, brass, pewter, steel and bronze
- Manufactured from hardened and tempered high grade steel, grade C60 tool steel
- Its cutting capacity ranges from 0.3mm to 2.4mm
- Favourite with the precious metal buyer, cut large bangles, bracelets, rings etc especially if there is suspicion of heavy plate on non precious metals, particularly lead or copper
- Semi-flush cut
- Length 180mm
- Weight 270 grams
- Made in Germany

Code	Description	UOM	Price
C33146	Faithfull (180mm) Heavy Duty	EACH	£19.95

**Knipex (200mm) Power Cut**



including Piano Wire.

KNIPEX cutters meet the highest demands in very many different applications. The breadth and depth of Knipex Cutter ensures that the best tool can always be found for every application.

KNIPEX cutters fulfil the highest expectations in terms of performance, ergonomics and service life. The products are designed to meet the requirements of professional users, who must be able to rely on their tools in day-to-day work.

- Blackened head, plastic coated handles, developed shaped for comfortable grip
- This product can cut from 0.3mm to 3.6mm in piano wire, gold, silver, platinum, palladium, steel, copper, brass, pewter and iron
- Its lever action allows exceptional cutting performance with minimal physical effort
- Induction-hardened precision cutting edges. Edge hardness approximately 64HRC
- Material: chrome-vanadium electric steel, oil hardened construction
- Favourite with the precious metal buyer, cut large bangles, bracelets, rings etc especially if there is suspicion of heavy plate on non precious metals, particularly lead or copper
- Bevelled cut
- Length 200mm
- Weight 350g
- Made in Germany

Code	Description	UOM	Price
C33145	Knipex (200mm) Power Cut	EACH	£55.65



Brass Sheet

See Page 1161



**Value (115mm)**



Only suitable for cutting material like solder, rubber, leather etc.

- Rounded tips
- Side cutters
- Length 115mm

Code	Description	UOM	Price
P4791	Value (115mm)	EACH	£3.95

**Value (115mm) Chunky Grip**



Only suitable for cutting material like solder, rubber, leather etc.

- Spring loaded sleeved arms
- Lap joint for better leverage
- Chunky, American style grip
- Length 115mm
- Heavy Duty Grip

Code	Description	UOM	Price
P40249	Value (115mm) Chunky Grip	EACH	£3.95

**Value (115mm) Pointed Tips**



Only suitable for cutting material like solder, rubber, leather etc.

- Pointed tips
- Side cutters
- Length 115mm

Code	Description	UOM	Price
P4789	Value (115mm) Pointed Tips	EACH	£4.50

Value (130mm)  
**VALUE**



Only suitable for cutting material like solder, rubber, leather etc.

- Rounded tips
- Side cutters
- Length 130mm

Code	Description	UOM	Price
P4790	Value (130mm)	EACH	£4.95

Value (130mm) Pointed Tips  
**VALUE**



Only suitable for cutting material like solder, rubber, leather etc.

- Pointed tips
- Side cutters
- Length 130mm

Code	Description	UOM	Price
P4788	Value (130mm) Pointed Tips	EACH	£5.95

**Diagonal or Side Cutters,  
Heavy Duty (Sprue)**

Casting, Sprue, Memory Wire and Rod End Cutters.

- Designed specifically for cutting casting sprues
- The compound joint and spring action provide maximum leverage with minimum effort
- Also useful for cutting thick and hard materials
- Multi leverage with return spring in handles
- Locking system holds cutters when not in use to protect edges
- Sprue cutters are popular to cut close to work and are great for precision cutting
- Most popular with precious metal scrap buyers
- Approx. cutting capacity: Ø3mm 9ct gold

Please be advised that cutters are not guaranteed against breakage or damage.



**A\*F Swiss (Angled Jaws) Length 210mm**



A\*F Swiss - Angled Jaws - Casting, Sprue, Memory Wire and Rod End Cutters.

- Locking System
- Semi Flush Cut
- for Casting
- Length 210mm
- with Compound Lever Action

Code	Description	UOM	Price
P9573	A*F Swiss (Angled Jaws) Length 210mm	EACH	£33.95

**A\*F Swiss (Flat Jaws) Length 210mm**



A\*F Swiss - Flat Jaws - Casting, Sprue, Memory Wire and Rod End Cutters.

- Locking System
- Bevelled Cut
- for Casting
- Length 210mm
- with Compound Lever Action

Code	Description	UOM	Price
P9572	A*F Swiss (Flat Jaws) Length 210mm	EACH	£31.65

**Bergeon (Angled Jaws) Length 260mm**



Bergeon 6599 - Angled Jaws - Casting, Sprue, Memory Wire and Rod End Cutters.

- Swiss Made
- Semi Flush Cut
- with Compound Lever Action
- Angled Jaws, Sturdy Cutters
- Double Reductions
- Locking System
- Cutting Width 22 mm

- Length 260 mm

Code	Description	UOM	Price
B0181	Bergeon (Angled Jaws) Length 260mm	EACH	£111.55

**Bergeon Angled Jaws**



Bergeon 6599L - Replacement Angled Jaws - Casting, Sprue, Memory Wire and Rod End Cutters.

- Swiss Made
- Replacement Jaws
- Semi Flush Cut
- Bergeon 6599L
- For Bergeon 6599 (B0181)

Code	Description	UOM	Price
B0181B	Bergeon Angled Jaws	EACH	£68.95

**Bergeon Tension Spring**



Bergeon 6599R - Replacement Tension Spring - Casting, Sprue, Memory Wire and Rod End Cutters.

- Swiss Made
- Replacement Tension Spring
- Bergeon 6599R
- For Bergeon 6599 (B0181)

Code	Description	UOM	Price
B0181A	Bergeon Tension Spring	EACH	£3.15

**Cousins (Angled Jaws) Length 210mm**



Japanese - Angled Jaws - Casting, Sprue, Memory Wire and Rod End Cutters.

- Semi Flush Cut
- for Casting
- Angled Jaws
- Length 210mm
- with Compound Lever Action
- Made in Japan

Code	Description	UOM	Price
P5009	Cousins (Angled Jaws) Length 210mm	EACH	£14.50



**Parallel Action Pliers**



See Page 950

## Value (Flat Jaws) Length 210mm

**VALUE**



Value - Flat Jaws - Easy Grip Handles - Casting, Sprue, Memory Wire and Rod End Cutters.

- Locking Clip
- Plastic Easy Grip Handles
- Bevelled Cut
- for Casting
- Length 210mm

Code	Description	UOM	Price
P36314	Value (Flat Jaws) Length 210mm	EACH	£7.95

## Diagonal or Side, Heavy Duty (for Clock Gongs & Rods)

**FAITHFULL**  
QUALITY TOOLS



Clock Gong/Rod (Bolt) Cutters - Faithfull

This Faithful quality high tensile cutter is suitable for cutting a wide range of materials such as gold, silver, platinum, palladium, copper, brass, mild steel, semi-hard steel, hard steel, non ferrous metals, reinforcing bars, spring wire, wrought iron and stainless steel.

The jaws/blades of these Bolt Cutters are made of heavily alloyed steel that are entirely drop forged giving a hardened blade able to withstand heavy use. The ground cutting edge is subjected to a second hardening process for maximum hardness of the cutting edge. The handles are full forged in a ribbed selection alloy steel of a very high elastic limit.

- Favourite with precious metal buyer, cut large bangles, rings, chains, and bracelets if there is a suspicion of heavy plate on none precious metals, particularly lead or copper.

Capacity:

- Mild Steel: 6.5 mm
- High Tensile: 4.8 mm
- Length: 355 mm (14" inch).
- Type: Centre cut
- Weight 1300g
- Bevelled cut

Please note: never twist the cutter before the material has completely parted. This imposes undue stress on the cutter leading to a rapid deterioration in performance and eventual failure. Select materials sufficient capacity and never cut martial of a greater

size then is recommended. Most materials will when they are cut safety goggles/glasses should be worn.

Code	Description	UOM	Price
C33144	Faithfull (Length 355mm)	EACH	£34.95

## Diagonal or Side, Super Heavy Duty (for Clock Gongs & Rods)



Clock Gong/Rod (Bolt) Cutters - Made In Japan - HIT

The Jaws are made of drop forged high grade alloy tool steel with heat treated, precision cutting edges for longer cutting life.

These bolt cutters are suitable for cutting a wide range of materials such as gold, silver, platinum, palladium, copper, brass, mild steel, semi-hard steel, hard steel, non ferrous metals, reinforcing bars, spring wire, wrought iron and stainless steel.

Also a favourite with precious metal buyers to cut large bangles, rings, chains, and bracelets if there is a suspicion of heavy plate on none precious metals, particularly lead or copper.

Maximum hardness of material to be cut: Brinell 370/ Rockwell C42, 85 Tons/Sq. 133 Kg/square mm.

- 14, 18 or 24 inch
- Rubber grip handles
- 14 & 18 inch are clipper cut (30 degree) jaws
- 24 inch are centre cut jaws
- Stainless Steel
- Made in Japan

Capacity:

- C39322: 7mm (Clipper cut)
- C39323: 8mm (Clipper cut)
- C39324: 10mm (Centre cut)

Please note: never twist the cutter before the material has completely parted. This imposes undue stress on the cutter leading to a rapid deterioration in performance and eventual failure. Select materials sufficient capacity and never cut martial of a greater size then is recommended. Most materials will when they are cut safety goggles/glasses should be worn

Code	Description	UOM	Price
C39322	HIT (Length 355mm) Capacity 7mm	EACH	£15.95
C39323	HIT (Length 450mm) Capacity 8mm	EACH	£18.95
C39324	HIT (Length 610mm) Capacity 10mm	EACH	£22.95

**www.** Online Discounts

Digital Vernier Gauges

See Page 928



## End or Top (Oblique) Cutters

Oblique cutters which are similar in design to end cutters, but with jaws that are slightly offset to one side. The offset provides increased clearance

- Cutters are industry standard and are not suitable for cutting stainless steel

Please be advised that cutters are not guaranteed against breakage or damage.

## A\*F Swiss (115mm)

**A\*F**  
SWITZERLAND



A\*F Swiss

- Oblique Cutting
- Polished Steel
- Box Joint
- Blue Plastic Covered Handles

Code	Description	UOM	Price
P32081	A*F Swiss (115mm)	EACH	£20.95

## A\*F Swiss (115mm) Smart Grip

**A\*F**  
SWITZERLAND



A\*F Swiss

Superb quality cutters with comfortable "Smart Grip" blue and black handles.

- Oblique Cutters
- Length 115mm

Code	Description	UOM	Price
C47346	A*F Swiss (115mm) Smart Grip	EACH	£25.75

**SECURE** ONLINE ORDERING

Wooden Plier Stand

See Page 781



**Bergeon (110mm) Specialist Hairspring**



Bergeon 5906.17 - Swiss Made

Precision nippers for cutting hairsprings and soft metals

- Oblique Nosed
- Length 110mm

The criterion adopted by the manufacturers to define soft metals is copper wire diameter Ø1.20mm & similar. These cutters are not guaranteed against brass, steel, nickel, gold or silver alloys

Code	Description	UOM	Price
C47383	Bergeon (110mm) Specialist Hairspring	EACH	£172.50

**Bergeon (130mm)**



- Bergeon 2628
- Swiss Made
- Oblique end cutting
- Polished steel
- Plastic covered Handles
- Box Joint

Code	Description	UOM	Price
P1255	Bergeon (130mm)	EACH	£37.50

Angle Grinder Attachment, Foredom



See Page 698

Pliers with Plastic Jaws



See Page 948

**Cousins Swiss Style (130mm) Smart Grip**



Cousins Swiss Style Superb Swiss quality cutters with comfortable "Smart Grip" blue and black handles.

- Oblique Cutters
- Length 130mm

Code	Description	UOM	Price
C48563	Cousins Swiss Style (130mm) Smart Grip	EACH	£13.95

**End or Top (Straight) Cutters**

Super Flush Cut: Take a look at our excellent range of top cutters, ideal for precision fine cutting and getting a very close cut that those side cutters might struggle with.

- The cutting edges of these cutters are set at right angles to provide easier access to tight areas.
- Better suited than diagonal cutters for snipping protruding wire ends
- Also available are oblique cutters which are similar in design to end cutters, but with jaws that are slightly offset to one side. The offset provides increased clearance
- Cutters are industry standard and are not suitable for cutting stainless steel
- Value cutters are only suitable for cutting material like solder, rubber, leather etc.

Please be advised that cutters are not guaranteed against breakage or damage.

**A\*F Swiss (115mm)**



A\*F Swiss Superior quality cutters in polished steel with box joint. Blue plastic handles with double leaf springs.

- Straight Cutters
- Length 115mm

Code	Description	UOM	Price
C47348	A*F Swiss (115mm)	EACH	£19.95

**A\*F Swiss (115mm) Smart Grip**



A\*F Swiss

Superb quality cutters with comfortable "Smart Grip" blue and black handles.

- Straight Cutters
- Length 115mm

Code	Description	UOM	Price
C47347	A*F Swiss (115mm) Smart Grip	EACH	£23.25

**A\*F Swiss (130mm) Tungsten Carbide**



A\*F Swiss

Heavy duty end cutter with tungsten carbide cutting edges. Ideal for cutting hard metal such as watch winding stems etc.

- Plastic Covered Handles
- Box joint
- Polished Steel
- with Leaf Springs
- Length 130mm

Code	Description	UOM	Price
C47109	A*F Swiss (130mm) Tungsten Carbide	EACH	£29.95

**Bergeon (110mm) Specialist Hairspring**



Bergeon 5906.16 - Swiss Made

Precision nippers for cutting hairsprings and soft metals

- Straight Nosed
- Length 110mm

The criterion adopted by the manufacturers to define soft metals is copper wire diameter Ø1.20mm & similar. These cutters are not guaranteed against brass, steel, nickel, gold or silver alloys

Code	Description	UOM	Price
C47382	Bergeon (110mm) Specialist Hairspring	EACH	£169.95

## Bergeon (130mm)



- Bergeon 2627
- Swiss Made
- Straight end cutting
- Polished steel
- Plastic covered arms
- Length 130mm
- Box Joint

Code	Description	UOM	Price
P1254	Bergeon (130mm)	EACH	£38.95

## Bergeon (140mm) Heavy Duty



- Bergeon 6764
- Straight end cutting
- Polished steel
- Plastic covered arms
- Length 140mm
- Box Joint

Cutting Capacity:

- Copper up to Ø4.0mm
- Steel up to Ø1.5mm

Code	Description	UOM	Price
C47384	Bergeon (140mm) Heavy Duty	EACH	£21.15

## Cousins Swiss Style (130mm) Smart Grip



Cousins Swiss Style Superb Swiss quality cutters with comfortable "Smart Grip" blue and black handles.

- Straight Cutters
- Length 130mm

Code	Description	UOM	Price
C48562	Cousins Swiss Style (130mm) Smart Grip	EACH	£12.95

## Value (100mm) Jaws 15mm



Only suitable for cutting material like solder, rubber, leather etc.

- Jaw Width 15mm
- Length 115mm
- Sprung Loaded

Code	Description	UOM	Price
P4794	Value (100mm) Jaws 15mm	EACH	£4.95

## Value (100mm) Jaws 20mm



Only suitable for cutting material like solder, rubber, leather etc.

- Jaw Width 20mm
- Length 115mm

- Sprung Loaded

Code	Description	UOM	Price
P4793	Value (100mm) Jaws 20mm	EACH	£7.95

## Value (100mm) Chunky Grip



Only suitable for cutting material like solder, rubber, leather etc.

- Heavy Duty Grip
- Spring loaded sleeved arms
- Lap joint for better leverage
- Chunky, American style grip
- Jaw Width 12mm
- Length 100mm

Code	Description	UOM	Price
P40251	Value (100mm) Chunky Grip	EACH	£3.95

## Value (100mm) for Stems



For Watch Winding Stems (limited use)

- Plastic covered Handles
- Length 100mm
- Non EU

Code	Description	UOM	Price
P36103	Value (100mm) for Stems	EACH	£5.95

# Pliers All Types

See Page 941

Tool Rack  
Organiser

See Page 780



Belt Sander  
Attachment,  
Foredom

See Page 698



**End or Top Cutters,**  
**Heavy Duty**

Cutters for end castings, sprues, memory wire, watch mesh (milanais) bracelets and rod ends.

- Our end cutters are popular as they can cut close to work, making them great for precision cutting
- Multi leverage with return spring in handles
- Most popular with precious metal scrap buyers

Please be advised that cutters are not guaranteed against breakage or damage.

**A\*F Swiss (Jaws 17mm x Length 210mm)**



A\*F Swiss - Cutters for end castings, sprues, memory wire, watch mesh (milanais) bracelets and rod ends.

- Locking system holds cutters when not in use to protect edges
- Approx. cutting capacity: Ø3mm 9ct Gold
- Semi Flush
- Length 210mm
- Jaw Width 17mm
- Opening 4mm

Code	Description	UOM	Price
P9574	A*F Swiss (Jaws 17mm x Length 210mm)	EACH	£28.60

**Bergeon Swiss (Jaws 22mm x Length 240mm)**



Bergeon 6496 - Cutters for end castings, sprues, memory wire, watch mesh (milanais) bracelets and rod ends.

- The original mesh bracelet cutter/trimmer used for generations by the top Swiss watch houses
- Hardened steel cutting jaws make a clean cut with one closing action
- The pressure exerted is multiplied many times by the unique lever design
- It therefore requires minimum effort from the user
- Approx. cutting capacity: Ø3mm 9ct gold
- Semi Flush
- Locking System
- Length 240mm
- Jaws Width 22mm

Code	Description	UOM	Price
B0139	Bergeon Swiss (Jaws 22mm x Length 240mm)	EACH	£97.10

**Cousins (Jaws 16mm x Length 210mm)**



Japanese - Cutters for end castings, sprues, memory wire, watch mesh (milanais) bracelets and rod ends.

- Locking System
- Approx. cutting capacity: Ø3mm 9ct Gold
- Semi Flush
- Length 210mm
- Jaw Width 16mm
- Opening 4mm

Code	Description	UOM	Price
P5167	Cousins (Jaws 16mm x Length 210mm)	EACH	£19.95

**Lindstrom (80-Series) Cutters**

The technology that truly "started it all"

This Lindstrom 80-Series remains the top choice for the traditional user. This range of cutters offers unsurpassed cutting capacity covering a wide range of wire dimensions and types.

Cuts:

- Micro Bevel Cut
- Flush Cut
- Ultra Flush Cut
- See PDF for full explanation and pictures

Handling:

- All cutters from the 80-Series are equipped with a precision screw joint
- This minimizes friction
- Maximizes alignment of cutting edges

Hardness:

- Lindstrom guarantee 63 to 65 Rockwell hardness
- Lindstrom state that their cutters are suitable for copper wire from Ø0.1 to Ø1.0mm. This can be used as a guide for other materials
- Cutters are industry standard and are not suitable for cutting stainless steel

Specifications:

- Cut (Jaw Length) Lindstrom number

Please be advised that cutters are not guaranteed against breakage or damage

Click website "More Information" & "PDFs" for full specification.

**PRICE PROMISE GUARANTEE** ✓

**Tool Rack**

See Page 781

**Flush Cut (8mm) Lindstrom 8131**



- 8mm cutting length
- 8mm wide jaws
- Flush cut
- Lindstrom 8131

Code	Description	UOM	Price
P19495	Flush Cut (8mm) Lindstrom 8131	EACH	£25.60

**Flush Cut (10mm) Lindstrom 8141**



- 10mm cutting length
- 10mm wide jaws
- Flush cut
- Lindstrom 8141

Code	Description	UOM	Price
P19498	Flush Cut (10mm) Lindstrom 8141	EACH	£30.50

**Flush Cut (12.5mm) Lindstrom 8151**



- 12.5mm cutting length
- 12.5mm wide jaws
- Flush cut
- Lindstrom 8151

Code	Description	UOM	Price
P19501	Flush Cut (12.5mm) Lindstrom 8151	EACH	£34.95

**Plastic & Steel Plier Stand**

See Page 780



**Flush Cut (16mm) Lindstrom 8161**



- 16mm cutting length
- 16mm wide jaws
- Flush cut
- Lindstrom 8161

Code	Description	UOM	Price
P19504	Flush Cut (16mm) Lindstrom 8161	EACH	£39.95

**Micro Bevel Cut (12.5mm) Lindstrom 8150**



- 12.5mm cutting length
- 12.5mm wide jaws
- Micro Bevel Cut
- Lindstrom 8150

Code	Description	UOM	Price
P19500	Micro Bevel Cut (12.5mm) Lindstrom 8150	EACH	£34.95

**Ultra Flush Cut (10mm) Lindstrom 8142**



- 10mm cutting length
- 10mm wide jaws
- Ultra flush cut
- Lindstrom 8142

Code	Description	UOM	Price
P19499	Ultra Flush Cut (10mm) Lindstrom 8142	EACH	£35.85

**Micro Bevel Cut (8mm) Lindstrom 8130**



- 8mm cutting length
- 8mm wide jaws
- Micro Bevel Cut
- Lindstrom 8130

Code	Description	UOM	Price
P19494	Micro Bevel Cut (8mm) Lindstrom 8130	EACH	£30.50

**Micro Bevel Cut (16mm) Lindstrom 8160**



- 16mm cutting length
- 16mm wide jaws
- Micro Bevel Cut
- Lindstrom 8160

Code	Description	UOM	Price
P19503	Micro Bevel Cut (16mm) Lindstrom 8160	EACH	£38.50

**Ultra Flush Cut (12mm) Lindstrom 8152**



- 12.5mm cutting length
- 12.5mm wide jaws
- Ultra flush cut
- Lindstrom 8152

Code	Description	UOM	Price
P19502	Ultra Flush Cut (12mm) Lindstrom 8152	EACH	£33.95

**Micro Bevel Cut (10mm) Lindstrom 8140**



- 10mm cutting length
- 10mm wide jaws
- Micro Bevel Cut
- Lindstrom 8140

Code	Description	UOM	Price
P19497	Micro Bevel Cut (10mm) Lindstrom 8140	EACH	£27.95

**Ultra Flush Cut (8mm) Lindstrom 8132**



- 8mm cutting length
- 8mm wide jaws
- Ultra flush cut
- Lindstrom 8132

Code	Description	UOM	Price
P19496	Ultra Flush Cut (8mm) Lindstrom 8132	EACH	£41.95

**Ultra Flush Cut (16mm) Lindstrom 8162**



- 16mm cutting length
- 16mm wide jaws
- Ultra flush cut
- Lindstrom 8162

Code	Description	UOM	Price
P19505	Ultra Flush Cut (16mm) Lindstrom 8162	EACH	£41.25



**Lindstrom Lead Catcher**



- For securing cut off wire pieces
- For Lindstrom cutters 8130, 8131 & 8132

Code	Description	UOM	Price
C46266	Lindstrom Lead Catcher	EACH	£3.95

**Maun Cutters (Made in UK) Heavy Duty**

Maun Cutters established since 1944 - Made in UK - Semi Flush Cut

Maun Cutters comprise of compound lever action giving considerable mechanical advantage cuttings operations. Anti-rust finish with bright nickel plated handles and fully treated chemically anti glare blacked cutting jaws. This is especially useful when the pressure exerted should be applied with exactly opposite force without slippage.

Cutters with cutting jaws are constructed of high quality materials which are to provide exceptional durability and give you extra comfort plus power because of the unique compound lever action pliers construction. Also available in plastic-coated cushion grip handles provides maximum comfort

The essential features of all Maun cutting nippers are the accuracy of the cutting edges and the quality of the steel and heat treatment.

The compound lever design gives good mechanical advantage, allowing the plier to cut piano wire with handle loads significantly less than conventional forged pliers of equivalent size.

Please note cutters are industry standard and are not suitable for cutting stainless steel

**End Cutters (Length 150mm)**



- Maun 3010.150 - Made in UK
- Length: 150mm
  - Maximum Hard Wire Cutting Ø2.00mm
  - Maximum Opening: 4mm

Code	Description	UOM	Price
P33215	End Cutters (Length 150mm)	EACH	£28.25

**Side Cutters (Length 140mm) with PVC Sleeves**



- Maun 2999.140 - Made in UK
- Length: 140mm
  - Maximum Hard Wire Cutting Ø2.00mm
  - PVC Sleeves

Code	Description	UOM	Price
P33208	Side Cutters (Length 140mm) with PVC Sleeves	EACH	£26.85

**Side Cutters (Length 160mm) with PVC Sleeves**



- Maun 2999.160 - Made in UK
- Length: 160mm
  - Maximum Hard Wire Cutting Ø2.00mm
  - PVC Sleeves

Code	Description	UOM	Price
P33207	Side Cutters (Length 160mm) with PVC Sleeves	EACH	£29.25

**Side Cutters (Length 160mm)**



- Maun 2990.160 - Made in UK
- Length: 160mm
  - Maximum Hard Wire Cutting Ø2.00mm

Code	Description	UOM	Price
P33209	Side Cutters (Length 160mm)	EACH	£28.20

**Side Cutters (Length 220mm) with PVC Sleeves**



- Maun 3018.200 - Made in UK
- Length: 220mm
  - Maximum Hard Wire Cutting Ø2.50mm

Code	Description	UOM	Price
P33216	Side Cutters (Length 220mm) with PVC Sleeves	EACH	£69.95

**Swisotech (Chunky Handle) Cutters**

High Quality - Ergonomic Chunky Handles - Swiss Made Cutters

- Cuts:
- Micro Bevel Cut - Flush Cut - Ultra Flush Cut
  - See PDF for full explanation and pictures

- Handling:
- Ergonomic, easy to operate & comfortable chunky handles
  - Spring loaded stainless steel box joint
  - All cutters are equipped with a precision screw joint
  - Maximizes alignment of cutting edges
  - Each cutter comes complete with protective jaw cap

- Hardness:
- 63 Rockwell hardness
  - For suitable cutting diameters please see additional information on each cutter
  - Cutters are industry standard and are not suitable for cutting stainless steel

- Specifications:
- Cut x (Cut Range) x Jaw Length

Please be advised that cutters are not guaranteed against breakage or damage

**Flush Cut (Ø0.1 to Ø1.2mm) 10mm swisotech®**



- Swisotech S8141
- Suitable for copper wire from Ø0.1 to Ø1.2mm
  - This can be used as a guide for other materials
  - Flush Cut

Code	Description	UOM	Price
P44184	Flush Cut (Ø0.1 to Ø1.2mm) 10mm	EACH	£24.50

**Flush Cut (Ø0.2 to Ø1.6mm)**

**12.5mm**

**swisotech®**



Swisotech S8151

- Suitable for copper wire from Ø0.2 to Ø1.6mm
- This can be used as a guide for other materials
- Flush Cut

Code	Description	UOM	Price
P44187	Flush Cut (Ø0.2 to Ø1.6mm) 12.5mm	EACH	£25.95

**Micro Bevel Cut (Ø0.3 to Ø1.6mm)**

**12.5mm**

**swisotech®**



Swisotech S8150

- Suitable for copper wire from Ø0.3 to Ø1.6mm
- This can be used as a guide for other materials
- Micro Bevel Cut

Code	Description	UOM	Price
P44186	Micro Bevel Cut (Ø0.3 to Ø1.6mm) 12.5mm	EACH	£24.95

• Ultra Flush Cut

Code	Description	UOM	Price
P44185	Ultra Flush Cut (Ø0.1 to Ø1.0mm) 10mm	EACH	£27.25

**Ultra Flush Cut (Ø0.2 to Ø1.2mm)**

**12.5mm**

**swisotech®**



Swisotech S8152

- Suitable for copper wire from Ø0.2 to Ø1.2mm
- This can be used as a guide for other materials
- Ultra Flush Cut

Code	Description	UOM	Price
P44188	Ultra Flush Cut (Ø0.2 to Ø1.2mm) 12.5mm	EACH	£30.95

**Flush Cut (Ø0.4 to Ø2.5mm) 16mm**

**swisotech®**



Swisotech S8161

- Suitable for copper wire from Ø0.4 to Ø2.5mm
- This can be used as a guide for other materials
- Flush Cut

Code	Description	UOM	Price
P44190	Flush Cut (Ø0.4 to Ø2.5mm) 16mm	EACH	£29.95

**Micro Bevel Cut (Ø0.5 to Ø3.0mm)**

**16mm**

**swisotech®**



Swisotech S8160

- Suitable for copper wire from Ø0.5 to Ø3.0mm
- This can be used as a guide for other materials
- Micro Bevel Cut

Code	Description	UOM	Price
P44189	Micro Bevel Cut (Ø0.5 to Ø3.0mm) 16mm	EACH	£25.95

**Ultra Flush Cut (Ø0.4 to Ø2.5mm)**

**16mm**

**swisotech®**



Swisotech S8162

- Suitable for copper wire from Ø0.4 to Ø2.5mm
- This can be used as a guide for other materials
- Ultra Flush Cut

Code	Description	UOM	Price
P44191	Ultra Flush Cut (Ø0.4 to Ø2.5mm) 16mm	EACH	£33.25

**Micro Bevel Cut (Ø0.1 to Ø1.2mm)**

**10mm**

**swisotech®**



Swisotech S8140

- Suitable for copper wire from Ø0.2 to Ø1.2mm
- This can be used as a guide for other materials
- Micro Bevel Cut

Code	Description	UOM	Price
P44183	Micro Bevel Cut (Ø0.1 to Ø1.2mm) 10mm	EACH	£24.95

**Ultra Flush Cut (Ø0.1 to Ø1.0mm)**

**10mm**

**swisotech®**



Swisotech S8142

- Suitable for copper wire from Ø0.1 to Ø1.0mm
- This can be used as a guide for other materials

**Tool Rack Organiser**

**BEST SELLER**

**Ref: T45704 See Page: 780**

**Xuron (USA Made) Cutters**

Timeless engineered hand tools

Made in U S A - Full Flush

Xuron patented Micro-Shear cutting action provide a super flush cut (no pinch or bevel).

Xuron are considered the best of the best in its range of pliers and cutters in the world, take a glance at our large range, there is always something to suit you.

Xuron Corporation is one of the world's leading manufacturers of ergonomic precision-grade hand tools for jewellery, silversmith arts/craft model maker, electronics, aerospace, plastic moulding, hobbies, craft, floral and fishing Industries.

Xuron holds numerous domestic and international patents, including an inventor's patent for the original Micro-Shear® flush cutter and its unique cutting action.

What is a Micro-Shear®?

The term Micro-Shear® describes the blade bypass shear cutting action that is unique to all Xuron cutters.

Shear cutting reduces cutting effort (as compared to traditional compression cutting) and extends blade life because the sharp edges are not meeting edge to edge. Shear cutting also produces clean, flat cuts.

Xuron tools are manufactured in Saco, Maine, where quality, an outstanding work ethic and flawless craftsmanship are a long-time tradition.

Cutters are industry standard and are not suitable for cutting stainless steel

**Hard Wire Cutter, Xuron 2193**



Xuron 2193 HWAC stands for Hardened Wire and Cable. The HWAC is rated for hardened wire, music wire, memory wire and throttle cable. So the cutting of precious or none metals such as gold, silver, platinum, copper, brass etc is effortless and exceptionally effective. It does not require any special cutting technique. This is an ideal tool for craftspeople that need to cut a wide variety of materials. Use our HWAC cutter like any cutter

- Place the material between the jaws at the desired location and squeeze on the handles.
- Cutting effort is minimal due to the tools' shearing action.
- Cushioned Xuron-Rubber™ grips for comfort and Light Touch™ spring action returns to its open position.
- Overall length 152mm (6" inch)
- Jaw Length 13mm
- Flush cuts copper & 9ct wires up to 3.00mm
- Flush cuts hard wires (platinum) up to 1.60mm

Code	Description	UOM	Price
P33221	Hard Wire Cutter, Xuron 2193	EACH	£9.65

**Scissor Cutter, Xuron 9180NS**



Xuron 9180NS esigned to cut through precious and non-precious metals, the 9180 precision shear features high carbon, smooth steel blades.

It is user friendly while optimizing durability and precision, the 9180 fits comfortably in both hands.

- Ergonomic Xuron-Rubber™ non-slip grips cushion the hand
- Elimination of finger loops ensures positioning flexibility to help alleviate fatigue
- A convenient return spring re-opens the shear after each cut
- Ideal for all applications that involve extended cutting time
- Overall length 152mm (6" inch)
- Jaw Length 21.5mm
- Flush cuts copper & 9ct wires up to 2.00mm
- Flush cuts copper & 9ct sheet up to 1.00mm
- High Durability
- Smooth Blades

Code	Description	UOM	Price
P33224	Scissor Cutter, Xuron 9180NS	EACH	£11.95

**Side Flush Cutter, Xuron 2175, Best Seller**



Xuron 2175 A large, strong and durable diagonal cutter ideal for use in a variety of industries. It's perfect cutting fine wire such as gold silver copper brass etc. Delivers a clean, square cut with minimal effort while our Light Touch™ return spring speeds work. Head shape allows excellent sight lines to help increase precision. Cushioned, Xuron-Rubber™ grips add comfort during extended work periods. Glare eliminating finish reduces eye strain.

- The Most Popular Flush Cutter
- 152mm overall length for smaller hands and maximum manoeuvrability.
- 12mm Jaw Length
- Flush cuts copper & 9ct wires up to 2.50mm
- 20 degree angle
- Maxi-Shear

Code	Description	UOM	Price
P8872	Side Flush Cutter, Xuron 2175, Best Seller	EACH	£8.25



**Side Flush Cutter (fine), Xuron 170-II**



Xuron 170-II Their shearing cut requires only about half the effort to cut a wire as that required by a conventional compression type cutter.

- Advanced ergonomic shape Xuron-Rubber™ grips
- A glare eliminating black finish
- Light weight
- Light Touch™ return spring
- Manufactured from high carbon steel
- Rockwell hardness 54-56C
- Produces a flat, flush cut
- Its slim profile increases access in high density area
- 127mm overall length for smaller hands and maximum manoeuvrability
- 9mm Jaw Length
- Flush cuts copper & 9ct wires up to 1.50mm
- 20 degree angle

Code	Description	UOM	Price
P33223	Side Flush Cutter (fine), Xuron 170-II	EACH	£4.50

**Side Flush Cutter (LX), Xuron**



Xuron 90174 LX shears are premium grade Micro-Shear® flush cutters offering added capacity and durability. Their high carbon steel blades are precision ground to ultra sharp cutting edges. LX Series Micro-Shear® flush cutters receive a unique, state of the art heat treating process for a Rockwell hardness of 57-59 C. The result is a tough, precise, durable flush cutter capable of reliably and economically cutting precious or none metals such as gold silver platinum copper brass etc. Shears feature ergonomically shaped, non-slip Xuron-Rubber™ grips, a glare resistant bright finish, and Light Touch™ return spring. Our patented Micro-Shear® cutting action combined with precision ground cutting edges, extra tough high carbon steel blades, an ultra slim profile for access in high density areas and the same enhanced ergonomic shape. 127mm overall length for smaller hands and maximum manoeuvrability. 9mm Jaw Length. Flush cuts copper & 9ct wires up to 2.00mm. 20 degree angle

Code	Description	UOM	Price
P33222	Side Flush Cutter (LX), Xuron	EACH	£7.95

**Shears (Beading) A\*F Swiss**

A\*F Swiss

This lightweight micro-shear thread cutter with fine blades is perfect for bead stringers and will cut bead cord, pearl thread, tags, etc.

- Protective Cap
- Overall Length 100mm
- Blade Length 30mm

**Beading Shears, A\*F Swiss**



A\*F Swiss

- Protective Cap
- Overall Length 100mm
- Blade Length 30mm

Code	Description	UOM	Price
P47135	Beading Shears, A*F Swiss	EACH	£5.95

**Shears (Jewellers)**

- For cutting sheet metal & snipping wire
- Sharp and sturdy
- Please be advised that cutters are not guaranteed against breakage or damage
- Cutters are industry standard and are not suitable for cutting stainless steel

**Curved End Jewellers Cutters**

**VALUE**



- Length 150mm
- For cutting sheet metal & snipping wire
- Sharp and sturdy

Code	Description	UOM	Price
P4797	Curved End Jewellers Cutters	EACH	£4.50

**Straight End Jewellers Cutters**

**VALUE**



- Length 150mm
- For cutting sheet metal & snipping wire
- Sharp and sturdy

Code	Description	UOM	Price
P4796	Straight End Jewellers Cutters	EACH	£4.50

**Straight End Jewellers Cutters, Bergeon**



- Bergeon 2374
- Straight shears with varnished handles.
- Length 175mm
- For cutting sheet metal & snipping wire
- Sharp and sturdy

Code	Description	UOM	Price
P1252	Straight End Jewellers Cutters, Bergeon	EACH	£19.25

**Shears (Jewellers) Gilbow**

The original Irwin Gilbow cutting snips were first designed in 1924 and have dominated the sheet metal cutting industry to such an extent that today, snips and shears are referred to as "Gilbows".

These Irwin Gilbow cutting snips have accurately ground edges that ensure the material being cut does not slip out of the jaws and become damaged. The hollow ground jaw faces provide a longer life to the cutting edge.

Gilbow cutters are jointed with a nut and bolt design essential in ensuring the longest possible life of the joint, whilst keeping a good easy smooth cutting movement.

Irwin Gilbow snips and shears have a great cutting capability which is much greater than the strength of the user and will provide a good, clean, easy cut edge to any work piece.

We have selection of various sizes and shaper to cater for all sorts of cutting jobs. Straight cutters are traditional, but take a look at a curved set. Very easy to cut out circles and

shapes with there unique curved blades.

- Can cut mild steel and non-ferrous metals up to 1.2mm (18g) thick
- Can cut stainless steel up to 0.46mm (23g) thick

Made in United Kingdom

Please note cutters are industry standard and are not suitable for cutting stainless steel

**175mm Straight Gilbow Cutters**



- Overall length 175mm
- Straight (flat) blade
- Accurately ground edges
- Weight: 170 grams

Code	Description	UOM	Price
C33149	175mm Straight Gilbow Cutters	EACH	£15.95

**175mm Curved Gilbow Cutters**



- Overall length 175mm
- Curved blade
- Accurately ground edges
- Weight: 170 grams

Code	Description	UOM	Price
C33150	175mm Curved Gilbow Cutters	EACH	£22.95

**Real or Fake Watches**



Ref: C40600  
See Page: 1382

**Bradbury's Hallmark 1544 to 2020**



Ref: C5784  
See Page: 1379

200mm Straight Gilbow Cutters



- Overall length 200mm
- Straight (flat) blade
- Accurately ground edges
- Weight: 265 grams

Code	Description	UOM	Price
C33151	200mm Straight Gilbow Cutters	EACH	£16.95

200mm Curved Gilbow Cutters



- Overall length 200mm
- Curved blade
- Accurately ground edges
- Weight: 265 grams

Code	Description	UOM	Price
C33148	200mm Curved Gilbow Cutters	EACH	£24.95

**Scissors (Crown)**

Ref: S48604  
See Page: 985

Tube & Joint Cutters

Joint & Tube Cutters are an excellent hand tool to cut tube quickly and accurately. Cutting tube and wire freely can result in an uneven cut, incurring waste of time and materials.

After cutting the tube/wire there is no filing involved, only the removal of the burr.

We stock this tool from a range of global manufacturers including Swiss, Italian, English and Indian manufacturers.

Do look at our complete range to ensure the most suitable product for you.

**Joint Leveller**

- Joint leveller for cutting metals such as gold/silver tube
- Traditional style tube and wire holding tool to give an accurate straight cut
- Made in India



How to use:

1. Place tube/wire in the triangle hole at the desired length to cut
2. Lock in the tube/wire by twisting the wooden handle
3. Using a saw piecing frame and blade rest the side of the frame against the flat part of the tube cutter and saw the tube ensuring that the frame rests against the tube cutter to ensure the best results
4. Please note the tube/wire will be indented with a small point mark because of the way this tools locks the item to be sawn

Code	Description	UOM	Price
J42156	Joint Leveller	EACH	£10.95

**Joint Leveller, Made in UK**

- Joint leveller for cutting metals such as gold/silver tube
- Traditional style tube and wire holding tool to give an accurate straight cut
- Made in UK



How to use:

1. Place tube/wire in the triangle hole at the desired length to cut
2. Lock in the tube/wire by twisting the wooden handle
3. Using a saw piecing frame and blade rest the side of the frame against the flat part of the tube cutter and saw the tube ensuring that the frame rests against the tube cutter to ensure the best results
4. Please note the tube/wire will be indented with a small point mark because of the way this tools locks the item to be sawn

Code	Description	UOM	Price
J4256	Joint Leveller, Made in UK	EACH	£33.75

**Joint Leveller with Back Plate**



- Joint leveller for cutting metals such as gold/silver tube
- Traditional style tube and wire holding tool to give an accurate straight cut
- Has back plate for extra stability and accuracy
- Made in India

How to use:

1. Place tube/wire in the triangle hole at the desired length to cut
2. Lock in the tube/wire by twisting the wooden handle
3. Using a saw piecing frame and blade rest the side of the frame against the flat part of the tube cutter and saw the tube ensuring that the frame rests against the tube cutter to ensure the best results
4. Please note the tube/wire will be indented with a small point mark because of the way this tools locks the item to be sawn

Code	Description	UOM	Price
J42157	Joint Leveller with Back Plate	EACH	£12.95

**Mitre/ Jewellers Jig, 45° & 90°**



After using this tool it will be your favourite you will ever have purchased

- File/cut perfect 45° & 90° angles in sheet, wire & tubes
- For metal sheets, wire and tubes etc.
- Such a handy little tool that allows you to fairly easily create true angles on the edges or faces of work pieces.
- With a perfect angle you will get a strong solder joint, your piece will have the look of profession workmanship
- Notice on the side at the bottom of the jig two hex grub screws and two holes at the bottom of the jig. Slide a piece of metal rod with a "L" bend through this hole and lock. This technique can be used as a measuring jig in order to have your pieces the same consistent size ("L" bar/Hex key size not supplied)
- Made from hardened steel

How to use:

1. The knurled knobs on the top screw up and down to loosen or tighten the jig.
2. Open the knobs until the piece you're working on slots into the opening you need, then tighten them enough to hold the piece.
3. The jig has a grooved area in it for holding wire or tube perpendicular to the depth of the jig, or for flat pieces you can put up against the straight tab for the same effect.
4. Place on your bench peg or vice depending if you're cutting or filing your mitre vice jig and with ease take away the unwanted part of your design

Size:

- Overall size: 50 x 70 x 9mm
- Jaw opening size 12mm
- Weight: 180g

Code	Description	UOM	Price
J35294	Mitre/ Jewellers Jig, 45° & 90°	EACH	£23.95

**+ Contact & Services**

**Your direct line to our Management Team** *Instant Message Service*

## Mitre / Jewellers Jig, 45°, 60°, 90°, 120° & 135°

After using this tool it will be your favourite you will ever have purchased

- File/cut perfect 45°, 60°, 90°, 120° & 135° angles in sheet, wire & tubes
- For metal sheets, wire and tubes etc.
- Such a handy little tool that allows you to fairly easily create true angles on the edges or faces of work pieces.
- With a perfect angle you will get a strong solder joint, your piece will have the look of profession workmanship
- Notice on the side at the bottom of the jig two hex grub screws and two holes at the bottom of the jig. Slide a piece of metal rod with a "L" bend through this hole and lock. This technique can be used as a measuring jig in order to have your pieces the same consistent size ("L" bar/Hex key size not supplied)
- Made from hardened steel

How to use:

1. The knurled knobs on the top screw up and down to loosen or tighten the jig.
2. Open the knobs until the piece you're working on slots into the opening you need, then tighten them enough to hold the piece.
3. The jig has a grooved area in it for holding wire or tube perpendicular to the depth of the jig, or for flat pieces you can put up against the straight tab for the same effect.
4. Place on your bench peg or vice depending if you're cutting or filing your mitre vice jig and with ease take away the unwanted part of your design

Size:

- Overall size: 50 x 70 x 9mm
- Jaw opening size: 12mm
- Weight: 180g

Code	Description	UOM	Price
M48851	Mitre / Jewellers Jig, 45°, 60°, 90°, 120° & 135°	EACH	£59.95



- With your thumb push down on the tube/wire whilst securing/holding the handle
- Put your piecing saw blade into the slit
- You can now start saw piecing the tube/wire vertically, accurately and with a flush finish

Details:

- For the jeweller, silversmith, arts, craft, contemporary jeweller, model makers and light engineers
- Easy tool for cutting tubing or rods
- Made of precision steel with a contoured sturdy handle; also comes with a removable handle for mounting the jig in a bench vice
- Capacity holding size 4.0mm
- Cut possibility 90 degrees
- Holds small tubing etc. for a clean flush cut
- Please note this item does not have a measuring slide

Code	Description	UOM	Price
J0886	Ø5mm (Max) Tube Cutting Jig, Bergeon	EACH	£129.95

## Ø5mm (Max) Tube Cutting Jig



Cousins Material House incredible value and best selling Joint Leveller is accurate for cutting tube/wire vertically faultlessly.

- Accurate tube/wire cutting vertically
- Gives flush cuts
- Can hold up to Ø5mm wire/tubing
- For the jeweller, silversmith, arts, craft, contemporary jeweller, model makers and light engineers.
- Easy tool for cutting tubing or rods
- Made of precision steel with a contoured sturdy handle; also comes with a removable handle for mounting the jig in a bench vice
- Capacity holding size 0 to 5mm
- Please note the gauge size (5) measures 0 to 30mm but the slide gauge actually extends up to 60mm
- 250 grams

How to use:

- Hold the handle (6), slide left to right to adjust to the desired size (4)
- Use the measuring gauge (5) to determine the tube/wire length size
- Lock the hexagonal nut (7) on the back so slide (4) so the tube/wire does not move
- With your thumb push down on the tube/wire with the securing/holding handle (2)
- Put your piecing saw blade into the slit (3)
- You can now start saw piecing the tube/wire vertically, accurately and with a flush finish.

Code	Description	UOM	Price
T31883	Ø5mm (Max) Tube Cutting Jig	EACH	£15.95



**BROWSE & BUY**



**Online Discounts**

## Ø10mm (Max) Tube Cutting Jig



Cousins Material House incredible value Joint Leveller is accurate for cutting tube/wire vertically faultlessly.

- Accurate tube/wire cutting vertically
- Gives flush cuts
- Can hold up to Ø10mm wire/tubing
- For the jeweller, silversmith, arts, craft, contemporary jeweller, model makers and light engineers.
- Easy tool for cutting tubing or rods.
- Made of precision steel with a contoured sturdy handle; also comes with a removable handle for mounting the jig in a bench vice.
- Capacity holding size 10.00mm
- Please note the gauge size (5) measures 0 to 30mm but the slide gauge actually extends up to 60mm.
- 250 grams

How to use...

As per item T31883 except tube/wire length measurement needs to be achieved manually by using the slide gauge with an additional ruler.

Code	Description	UOM	Price
T35170	Ø10mm (Max) Tube Cutting Jig	EACH	£12.95

## Ø10mm (Max) Tube Cutting Jig, Multiple Angles



An enhanced version of a fantastic tool. Cut tubes and wires to perfect angles with a flush using the angled tube cutter.

- 90, 15, 30 & 45 degree cuts all possible
- Gives flush cuts
- Accurate tube/wire cutting vertically
- Can hold up to Ø10mm wire/tubing
- For the jeweller, silversmith, arts, craft, contemporary jeweller, model makers and light engineers
- Easy tool for cutting tubing or rods
- Made of precision steel with a contoured sturdy handle; also comes with a removable handle for mounting the jig in a bench vice

How to use:

## Ø5mm (Max) Tube Cutting Jig, Bergeon



- Bergeon 6677
- High precision made in Switzerland
- Perfect and accurate tube/wire cutting vertically
- Up to 5mm capacity

How to use...

- Hold the handle & slide the movable gauge left to right to adjust to the desired size
- Use the measuring gauge to determine the tube/wire length size
- Lock the hexagonal nut on the back so the tube/wire does not move

- Hold the handle and move the extendible back plate to the desired tube length
- Lock the hexagonal nut on the side so the back plate does not move
- With your thumb push down on the tube/wire with the securing/holding handle
- Put your piecing saw blade into the desired slit
- You can now start saw piecing the tube/wire vertically, accurately and with a flush finish

Code	Description	UOM	Price
T42909	Ø10mm (Max) Tube Cutting Jig, Multiple Angles	EACH	£32.50

### Cutters - Guillotine Cutters

One of the most useful tools you will find in your workshop helping you cut sheet and wire metal to size accurately and quickly.

- Guillotines have been used in metal workshops for many generations, being one of the most traditional and common tools found in the industry
- Guillotines help the operators save a great deal of their energy and time
- Durston guillotine or non branded

Please be advised that cutters are not guaranteed against breakage or damage.

### Wire (up to Ø1.5mm) Guillotine



Bench top wire guillotine

- Precision ground with hardened steel blade.
- Sturdy metal construction that can be screwed to the bench or work surface (screws not supplied).
- Efficiently cuts wire to your desired length up to 60mm using the sliding rail. Simply lock the slide to the length of wire you would like to cut.
- Cuts wire from 0 – 1.5mm
- Comfortable plastic coated handle makes this tool easy to use.
- Very popular for jewellers, silversmiths, light engineers, model makers and for arts and crafts

Size: 100m x 120mm x 180mm

Code	Description	UOM	Price
G9471	Wire (up to Ø1.5mm) Guillotine	EACH	£18.25

### 30mm (Chain Cutter) Guillotine

Essential tool for the workshop particularly for watch and clock makers, jewellers, metal craft and model makers

- Applies a precise straight cut, extra flush
- With a beveled-cylinder cutting tool very useful for cutting mesh bands on watches/bracelet, solder wire and small pieces of sheet metal.
- The long handle provides maximum cutting leverage.
- Create various shapes, squares, rectangles, triangles and hex angles for your jewellery designs
- Cut wire or rod perfectly to a extra flush cut, no need for filing afterwards



- Will cut all sorts of metals; gold, silver, copper, brass, platinum, steel etc.
- Fitted with a sheet wire/rod securing adjustable plate
- Cast iron body base with steel construction parts
- Four bench screw mounting points
- Cutting capacity (approx): Sheet 1mm, rod/wire up to 2mm

Dimensions:

- 30mm wide cutting blade
- Base 135 x 100 x 65mm
- Handle length 250mm
- Weight: 2.2kg

Code	Description	UOM	Price
G34939	30mm (Chain Cutter) Guillotine	EACH	£29.95

### 150mm (Heavy Duty) Guillotine, E.U.



Heavy duty guillotine shear

- 150mm blades
- Cuts up to 3mm sheet and wire
- Sturdy metal construction can be bolted to your bench or work surface (bolts not supplied)
- 600mm handle provides leverage for easy use
- Very popular for jewellers, silversmiths, light engineers, model makers and for arts and crafts
- Made in E.U.

Size: 850mm x 290mm x 130mm  
Weight: 12kg

Code	Description	UOM	Price
G44144	150mm (Heavy Duty) Guillotine, E.U.	EACH	£165.00

### 150mm Spare Blade, E.U.

- Spare blade for G44144
- 150mm blade
- Includes bottom plate and blade



Code	Description	UOM	Price
G48190	150mm Spare Blade, E.U.	EACH	£67.95

### 150mm (Heavy Duty) Guillotine, India

Bench Sheet and Wire Sear Cutter

- Precision Ground , hardened tool steel blades 6 inches (150mm)
- Sturdy metal construction can be bolted to your bench or work surface (bolts not supplied)
- Cuts up to 3mm sheet and wire
- 600mm handle provides leverage for easy use
- Very popular for jewellers,



silversmiths, light engineers, model makers and for arts and crafts

Dimensions:

- Blade Width 150mm
- Size: 850mm x 290mm x 130mm
- Weight: 12kg

Code	Description	UOM	Price
B31892	150mm (Heavy Duty) Guillotine, India	EACH	£99.95

### 300mm (Heavy Duty) Guillotine, Durston

- Durston Guillotine, Heavy Duty
- Will cut up to 300mm wide by 4mm (8 gauge) thick non-ferrous metal and 2.5mm (12 gauge) mild steel.
- Precision ground, hardened and tempered blade.
- Blade can be turned round 4 times before it needs sharpening, so will give a lifetime of work for many users.
- Open back, allowing for any length of sheet.
- Long pulling bar making cutting easy.
- Guard situated at front of blade.
- Easy to read adjustable ruler connected to back stop.
- Squared front with 2 tightening screws
- Durston 1195
- Made in UK



Specifications:

- Weight: 52kg
- Width of Cut: 300mm
- Cut Capacity, Mild Steel: 2.5mm
- Cut Capacity, Non-Ferrous: 4.0mm
- Main Base Dimensions in mm: 470 x 210

Code	Description	UOM	Price
G32250	300mm (Heavy Duty) Guillotine, Durston	EACH	£795.00

### Clock Dial Cutter



- Excellent, adjustable paper dial cutter that cuts perfect circles from Ø2" to 16"
- Simply adjust to preferred size by sliding the brass lock into position
- Place one point on the paper where you want the centre of the circle to be and spin the cutter around 360° to form your perfect circle

Code	Description	UOM	Price
C32061	Clock Dial Cutter	EACH	£9.50

PRICE PROMISE GUARANTEE ✓

IMPROVED SPEED SEARCH



# DENTAL TOOLS

## Dental Kit



Dental Kit

- Pack\*3
- Can be sterilised
- Stainless steel

Kit contains:

- Inspection mirror, overall length 160mm, mirror diameter Ø22mm
- Bent, pointed spatula, overall length 145mm
- Tweezers, curved serrated tip, overall length 160mm

Code	Description	UOM	Price
D39327	Dental Kit	PACK*3	£2.95

## Haemostat Forceps



- Haemostat locking forceps
- Brilliant for holding items hands free
- Lift finger holes away from each other to unlock
- Serrated jaws
- Overall length 135mm

Code	Description	UOM	Price
S39496	Curved Blade Forceps	EACH	£2.95
S39495	Straight Blade Forceps	EACH	£2.95

## Inspection Mirror



Inspection Mirror

- Great for viewing hard to see areas of clock movements, jewellery work, etc
- Traditional dentist's inspection mirror
- Overall length 160mm
- Mirror diameter Ø22mm
- Stainless steel, knurled handle

Code	Description	UOM	Price
S39285	Inspection Mirror	EACH	£1.25

## Probe Set



- Pack\*3
- Can be sterilised
- Stainless steel
- Effective for scribing, polishing or in the dental trade
- Knurled handles
- Overall length 150mm

Kit contains;

- Straight end probe
- Right angle probe
- Hook probe

Code	Description	UOM	Price
P45722	Probe Set	PACK*3	£2.95

# DRILL BITS

## CORE DRILLS

### Core Drills, Diamond Coated, A\*F Swiss



A\*F Swiss

Use core drills to cut holes in ceramics, tile and glass without chipping or cracking. Our diamond coated Swiss made core drills have a Ø3.0mm shank, medium-fine grit and are made of hardened steel on which diamond particles have been electroplated.

- Cut holes in ceramics, tile and glass
- No chipping or cracking
- Swiss made
- Ø3.0mm shank
- Medium-fine grit

Available individually in diameters:

- 1.5 - 2.0 - 2.5 - 3.0 - 5.0 - 6.5 - 9.5 - 10.0 - 11.0mm

Code	Description	UOM	Price
D47369	Ø1.50mm Diamond Core Drill	EACH	£6.75
D47370	Ø2.00mm Diamond Core Drill	EACH	£6.75
D47371	Ø2.50mm Diamond Core Drill	EACH	£7.65
D47372	Ø3.00mm Diamond Core Drill	EACH	£7.65
D47373	Ø5.00mm Diamond Core Drill	EACH	£16.95
D47374	Ø6.50mm Diamond Core Drill	EACH	£16.50
D47375	Ø9.50mm Diamond Core Drill	EACH	£16.50
D47376	Ø10.00mm Diamond Core Drill	EACH	£18.50
D47377	Ø11.00mm Diamond Core Drill	EACH	£16.95

# DIAMOND COATED DRILL BITS

## Diamond Drill Bits, A\*F Swiss



A&F Swiss - High Quality - Diamond Coated Jewellery Drills

Superior quality diamond coated drill bits:

- Diamond particles are electroplated the the steel drill bits (no adhesive used)
- Longer lasting, superior reliability & greater accuracy retention
- Satisfaction guaranteed

Diamond coated drill bits are the ultimate for drilling stones, pearls, glass or ceramics.

- Very popular with jewellers, silversmiths, watch makers/repairers, light engineers, model makers plastic fabricators and for arts and crafts
- Used on a whole range of materials such as gold, silver, platinum, copper, brass, pewter, bronze and aluminium
- Also useful for drilling precious gems such as opals, sapphires & emeralds (please note great care is needed when working with such delicate items)
- Used on micromotors and very popular with quick release rotary hand pieces as changing your drill sizes are fast and easy
- Only a small amount of water needed as lubricant
- Grit 140/170

Sizes (approximate):

- Shank Ø2.35mm or 3/32"
- Length of whole drill: 44.5mm
- Drilling length 12mm
- Set includes: 1.00, 1.30, 1.40, 1.60, 1.80 & 2.10mm

Recommended rotary machines

- Jewellers Kit & No20 "Quick Release" Handpiece: K2220CE
- Freedom High Speed Rotary Micromotor Kit K1070CE
- Marathon (Korea) Micromotor & Handpiece M36961

Code	Description	UOM	Price
D0434	Diamond Coated Drill Set	EACH	£29.75
D22803	Ø0.80mm Diamond Drill	EACH	£5.85
D22804	Ø0.90mm Diamond Drill	EACH	£4.95
D33856	Ø1.00mm Diamond Drill	EACH	£4.95
D33857	Ø1.10mm Diamond Drill	EACH	£4.95
D33858	Ø1.10mm Diamond Drill	EACH	£4.95
D0436	Ø1.30mm Diamond Drill	EACH	£4.95
D0437	Ø1.40mm Diamond Drill	EACH	£4.95
D22806	Ø1.50mm Diamond Drill	EACH	£4.95
D0438	Ø1.60mm Diamond Drill	EACH	£4.95
D22807	Ø1.70mm Diamond Drill	EACH	£4.95
D0439	Ø1.80mm Diamond Drill	EACH	£4.95
D22808	Ø1.90mm Diamond Drill	EACH	£4.95
D0440	Ø2.10mm Diamond Drill	EACH	£4.95
D22810	Ø2.20mm Diamond Drill	EACH	£4.95
D22811	Ø2.30mm Diamond Drill	EACH	£4.95

Price breaks available, see website



## HSS DRILL BITS

Professional high speed steel (HSS) drill bits are manufactured from high quality grade tool steel to meet the requirements of today's high standards.

Each bit has a fully ground flute and cutting tip, featuring a 135 degree point angle and split point providing easy non-slip starting and precision drilling. All these great features help you to achieve superior performance in most materials

- Take advantage quantity discount for bulk buyers
- Suitable for use on gold, silver, platinum, copper, brass, aluminium, bronze, pewter, alloy steels, carbon steels, cast iron, cast steels, hardened alloy steels, stainless steels, plastics, wood and many more materials

Please note: ensure work piece is securely clamped when using in rotary tools and always wear suitable protection.

### Ø0.20 to Ø1.00mm, Dormer

Dormer Sheffield England

HSS - High Speed Steel

- High quality, Dormer drill bits
- Good self centring capability
- Can be used on a wide range of materials
- Suitable for hand or machine use
- HSS - High Speed Steel



Code	Description	UOM	Price
D35348	Ø0.20mm Twist Drill	EACH	£4.85
D35349	Ø0.30mm Twist Drill	EACH	£4.86
D35350	Ø0.35mm Twist Drill	EACH	£4.20
D35351	Ø0.40mm Twist Drill	EACH	£4.08
D35352	Ø0.45mm Twist Drill	EACH	£4.08
D35353	Ø0.50mm Twist Drill	EACH	£3.17
D35354	Ø0.55mm Twist Drill	EACH	£4.08
D35355	Ø0.60mm Twist Drill	EACH	£3.47
D35356	Ø0.65mm Twist Drill	EACH	£3.65
D35357	Ø0.70mm Twist Drill	EACH	£2.18
D35358	Ø0.75mm Twist Drill	EACH	£3.04
D35359	Ø0.80mm Twist Drill	EACH	£2.10
D35360	Ø0.85mm Twist Drill	EACH	£2.85
D35361	Ø0.90mm Twist Drill	EACH	£2.83
D35363	Ø1.00mm Twist Drill	EACH	£2.35

Price breaks available, see website

### Brass Sheet

See Page 1161



### Rotary Drills

See Page 661



### Ø0.30 to Ø5.00mm, Cousins

COUSINSUK



- HSS - High Speed Steel
- Metric sizes
- Supplied in packs of 10, 5 or 3
- Made in UK

Code	Description	UOM	Price
D35734	Ø0.30mm Twist Drill	PACK*10	£3.95
D35735	Ø0.35mm Twist Drill	PACK*10	£3.95
D35736	Ø0.40mm Twist Drill	PACK*10	£3.95
D35737	Ø0.45mm Twist Drill	PACK*10	£3.95
D35738	Ø0.50mm Twist Drill	PACK*10	£3.95
D35739	Ø0.55mm Twist Drill	PACK*10	£3.95
D35740	Ø0.60mm Twist Drill	PACK*10	£3.95
D35741	Ø0.65mm Twist Drill	PACK*10	£3.95
D35742	Ø0.70mm Twist Drill	PACK*10	£3.95
D35743	Ø0.75mm Twist Drill	PACK*10	£3.95
D35744	Ø0.80mm Twist Drill	PACK*10	£3.95
D35745	Ø0.85mm Twist Drill	PACK*10	£3.95
D35746	Ø0.90mm Twist Drill	PACK*10	£3.95
D35747	Ø0.95mm Twist Drill	PACK*10	£3.95
D35748	Ø1.00mm Twist Drill	PACK*10	£3.95
D35749	Ø1.10mm Twist Drill	PACK*10	£3.95
D35750	Ø1.20mm Twist Drill	PACK*10	£3.95
D35751	Ø1.30mm Twist Drill	PACK*10	£3.95
D35752	Ø1.40mm Twist Drill	PACK*10	£3.95
D35753	Ø1.50mm Twist Drill	PACK*10	£3.95
D35754	Ø1.60mm Twist Drill	PACK*10	£3.95
D35755	Ø1.70mm Twist Drill	PACK*10	£3.95
D35756	Ø1.80mm Twist Drill	PACK*10	£3.95
D35757	Ø1.90mm Twist Drill	PACK*10	£3.95
D35758	Ø2.00mm Twist Drill	PACK*10	£3.95
D47217	Ø2.10mm Twist Drill	PACK*10	£3.95
D47218	Ø2.20mm Twist Drill	PACK*10	£3.95
D47219	Ø2.30mm Twist Drill	PACK*10	£3.95
D47220	Ø2.40mm Twist Drill	PACK*10	£3.95
D47221	Ø2.50mm Twist Drill	PACK*10	£3.95
D47222	Ø2.60mm Twist Drill	PACK*5	£3.50
D47223	Ø2.70mm Twist Drill	PACK*5	£3.50
D47224	Ø2.80mm Twist Drill	PACK*5	£3.50
D47225	Ø2.90mm Twist Drill	PACK*5	£3.50
D47226	Ø3.00mm Twist Drill	PACK*5	£3.50
D47227	Ø3.10mm Twist Drill	PACK*5	£3.50
D47228	Ø3.20mm Twist Drill	PACK*5	£3.50
D47229	Ø3.30mm Twist Drill	PACK*5	£3.50
D47230	Ø3.40mm Twist Drill	PACK*5	£3.50
D47231	Ø3.50mm Twist Drill	PACK*5	£3.50
D47232	Ø3.60mm Twist Drill	PACK*3	£2.95
D47233	Ø3.70mm Twist Drill	PACK*3	£2.95
D47234	Ø3.80mm Twist Drill	PACK*3	£2.95
D47235	Ø3.90mm Twist Drill	PACK*3	£2.95
D47236	Ø4.00mm Twist Drill	PACK*3	£2.95
D47237	Ø4.10mm Twist Drill	PACK*3	£3.95
D47238	Ø4.20mm Twist Drill	PACK*3	£3.95
D47239	Ø4.30mm Twist Drill	PACK*3	£3.95
D47240	Ø4.40mm Twist Drill	PACK*3	£3.95
D47241	Ø4.50mm Twist Drill	PACK*3	£3.95
D47242	Ø4.60mm Twist Drill	PACK*3	£3.95
D47243	Ø4.70mm Twist Drill	PACK*3	£3.95
D47244	Ø4.80mm Twist Drill	PACK*3	£3.95
D47245	Ø4.90mm Twist Drill	PACK*3	£3.95
D47246	Ø5.00mm Twist Drill	PACK*3	£3.95

Price breaks available, see website

### Ø0.30 to Ø6.00mm, Indian

VALUE



- HSS - High Speed Steel
- Metric sizes
- Supplied in packs of 10
- Made in India

Code	Description	UOM	Price
D2410	Ø0.30mm Twist Drill	PACK*10	£1.95
D2411	Ø0.35mm Twist Drill	PACK*10	£1.95
D2412	Ø0.40mm Twist Drill	PACK*10	£1.95
D2413	Ø0.45mm Twist Drill	PACK*10	£1.95
D2414	Ø0.50mm Twist Drill	PACK*10	£1.95
D2415	Ø0.55mm Twist Drill	PACK*10	£1.95
D2416	Ø0.60mm Twist Drill	PACK*10	£1.95
D2417	Ø0.65mm Twist Drill	PACK*10	£1.95
D2418	Ø0.70mm Twist Drill	PACK*10	£1.95
D2419	Ø0.75mm Twist Drill	PACK*10	£1.95
D2420A	Ø0.80mm Twist Drill	PACK*10	£1.95
D2420B	Ø0.85mm Twist Drill	PACK*10	£1.95
D2421	Ø0.90mm Twist Drill	PACK*10	£1.95
D2422	Ø0.95mm Twist Drill	PACK*10	£1.95
D2423	Ø1.00mm Twist Drill	PACK*10	£1.95
D2424	Ø1.10mm Twist Drill	PACK*10	£2.40
D2426	Ø1.20mm Twist Drill	PACK*10	£2.40
D2425	Ø1.25mm Twist Drill	PACK*10	£2.40
D2427	Ø1.30mm Twist Drill	PACK*10	£2.40
D2428	Ø1.40mm Twist Drill	PACK*10	£2.40
D2429	Ø1.50mm Twist Drill	PACK*10	£2.40
D2430	Ø1.60mm Twist Drill	PACK*10	£2.40
D2431	Ø1.70mm Twist Drill	PACK*10	£2.40
D2432	Ø1.75mm Twist Drill	PACK*10	£2.40
D2433	Ø1.80mm Twist Drill	PACK*10	£2.95
D2434	Ø1.90mm Twist Drill	PACK*10	£2.40
D2435	Ø2.00mm Twist Drill	PACK*10	£2.40
D2436	Ø2.10mm Twist Drill	PACK*10	£2.95
D2437	Ø2.20mm Twist Drill	PACK*10	£2.95
D2438	Ø2.30mm Twist Drill	PACK*10	£2.95
D2439	Ø2.40mm Twist Drill	PACK*10	£2.95
D2440	Ø2.50mm Twist Drill	PACK*10	£2.95
D2441	Ø2.60mm Twist Drill	PACK*10	£2.95
D2442	Ø2.70mm Twist Drill	PACK*10	£2.95
D2443	Ø2.75mm Twist Drill	PACK*10	£2.95
D2444	Ø2.80mm Twist Drill	PACK*10	£2.95
D2445	Ø2.90mm Twist Drill	PACK*10	£2.95
D2446	Ø3.00mm Twist Drill	PACK*10	£2.95
D2447	Ø3.10mm Twist Drill	PACK*10	£3.60
D2448	Ø3.20mm Twist Drill	PACK*10	£3.60
D2449	Ø3.30mm Twist Drill	PACK*10	£3.60
D2450	Ø3.40mm Twist Drill	PACK*10	£3.60
D2451	Ø3.50mm Twist Drill	PACK*10	£3.60
D2452	Ø3.60mm Twist Drill	PACK*10	£3.60
D2453	Ø3.70mm Twist Drill	PACK*10	£3.60
D2454	Ø3.80mm Twist Drill	PACK*10	£3.60
D2455	Ø3.90mm Twist Drill	PACK*10	£3.60
D2456	Ø4.00mm Twist Drill	PACK*10	£3.60
D2459	Ø4.40mm Twist Drill	PACK*10	£3.60
D2457	Ø4.50mm Twist Drill	PACK*10	£3.60
D2460	Ø4.60mm Twist Drill	PACK*10	£3.60
D2458	Ø5.00mm Twist Drill	PACK*10	£3.60
D2461	Ø5.50mm Twist Drill	PACK*10	£3.60
D2462	Ø5.90mm Twist Drill	PACK*10	£3.60
D2463	Ø6.00mm Twist Drill	PACK*10	£3.60

Price breaks available, see website

Online Order Tracking

**Ø0.30 to Ø1.60mm Set**

**VALUE**



- Set 20 pieces
- Ø0.30 to Ø1.60mm
- Each drill compartment is marked with size
- Popular Set
- HSS - High Speed Steel

Code	Description	UOM	Price
D0442	Ø0.30 to Ø1.60mm Twist Drill Set	PACK*20	£4.25

**Ø1.50 to Ø6.50mm, Faithful Set**

**FAITHFULL®**  
QUALITY TOOLS



- Set 13 pieces
- Ø1.50 to 6.50mm
- Each drill compartment is marked with size
- Popular Set

Faithfull professional high speed steel (HSS) drill bits are manufactured from high quality grade tool steel, to meet the requirements today's high standards.

Each bit has a fully ground flute and cutting tip, featuring a 135 degree point angle and split point providing easy non-slip starting and precision drilling. All these great features help you to achieve superior performance in most materials

- Storage box included with drill size marking
- Available in loose format for bulk users.
- Suitable for use on gold silver platinum copper brass aluminium bronze pewter alloy steels carbon steels cast iron cast steels hardened alloy steels stainless steels plastics wood and many more materials.

Code	Description	UOM	Price
D33156	Ø1.50 to Ø6.50mm Twist Drill Set	PACK*13	£11.85

**Ø1.50 to Ø6.50mm Set**

**VALUE**



- Set 13 pieces
- Ø1.50 to Ø6.50mm
- Each drill compartment is marked with size
- Great value set
- HSS - High Speed Steel

Code	Description	UOM	Price
D39351	Ø1.50 to Ø6.50mm Twist Drill Set	PACK*13	£4.95

**Ø1.00 to Ø6.00mm, Dormer Set**

**DORMER**



- High quality, Dormer drill bits
- 51 pieces, from Ø1.00 to Ø6.00mm
- Good self centring capability
- Can be used on a wide range of materials
- Suitable for hand or machine use
- HSS - High Speed Steel
- Comes in a safe, easy access box

Code	Description	UOM	Price
D35492	Dormer HSS Drill Set Ø1.00 to Ø6.00mm	PACK*51	£125.00

**JEWELLERY DRILL BITS**

Jewellery drill bits are an industry standard size Ø2.35mm shank. This allows fast, smooth and seamless transition between sizes of drill, burrs and even silicones or mini mops, whilst using your pendant or micromotor. They are the most popular drill bits in the jewellery, horology and associated industries for this very reason. We have a large range of sizes available below.

- Shank body size, Ø2.35mm or 3/32"
- Are very popular for jewellers, silversmiths, watch makers/repairers, light engineers, model makers plastic fabricators and for arts and crafts
- Can be used on a whole range of materials such as gold, silver, platinum, copper, brass, pewter, bronze and aluminium
- Used with micro motors and quick release rotary hand pieces
- Shank drills are very popular for quick release headpieces as changing your drill sizes is fast and easy

Recommended rotary machines

- Jewellers Kit & No20 "Quick Release" Handpiece: K2220CE
- Foredom High Speed Rotary Micromotor Kit K1070CE
- Saeshin (Korea) Micromotor & Handpiece M9768

**Jewellery Drills, German**

**COUSINSUK**



- Made in Germany jewellery drills
- Shank body size, Ø2.35mm or 3/32"

Size:

- Length of whole drill: 45mm
- Drilling length, 12mm

Code	Description	UOM	Price
D35717	Ø0.50mm Jewellery Drill	EACH	£0.95
D35718	Ø0.60mm Jewellery Drill	EACH	£0.95
D35719	Ø0.70mm Jewellery Drill	EACH	£0.95
D35720	Ø0.80mm Jewellery Drill	EACH	£0.95
D35721	Ø0.90mm Jewellery Drill	EACH	£0.95
D35722	Ø1.00mm Jewellery Drill	EACH	£0.95
D35723	Ø1.20mm Jewellery Drill	EACH	£0.95
D35724	Ø1.30mm Jewellery Drill	EACH	£0.95
D35725	Ø1.40mm Jewellery Drill	EACH	£0.95
D35726	Ø1.50mm Jewellery Drill	EACH	£0.95
D35727	Ø1.60mm Jewellery Drill	EACH	£0.95
D35728	Ø1.70mm Jewellery Drill	EACH	£0.95
D35729	Ø1.80mm Jewellery Drill	EACH	£0.95
D35732	Ø2.00mm Jewellery Drill	EACH	£0.95

**Jewellery Drills, A\*F Swiss**



A World Favourite

- Swiss jewellery drills
- Shank body size, Ø2.35mm or 3/32"
- Alloy steel

Size:

- Length of whole drill: 45mm
- Drilling length, 12mm

Equivalent:

- Busch 203
- Maillefer 58PM

Code	Description	UOM	Price
D2464	Ø0.50mm Jewellery Drill	EACH	£2.95
D2465	Ø0.60mm Jewellery Drill	EACH	£2.95
D2466	Ø0.70mm Jewellery Drill	EACH	£2.95
D2467	Ø0.80mm Jewellery Drill	EACH	£2.95
D2468	Ø0.90mm Jewellery Drill	EACH	£2.95
D2469	Ø1.00mm Jewellery Drill	EACH	£2.95
D2470	Ø1.10mm Jewellery Drill	EACH	£3.25
D2471	Ø1.20mm Jewellery Drill	EACH	£3.25
D2472	Ø1.30mm Jewellery Drill	EACH	£3.25
D2473	Ø1.40mm Jewellery Drill	EACH	£3.25
D2474	Ø1.50mm Jewellery Drill	EACH	£3.25
D2475	Ø1.60mm Jewellery Drill	EACH	£3.25
D32405	Ø1.70mm Jewellery Drill	EACH	£3.25
D2476	Ø1.80mm Jewellery Drill	EACH	£3.25
D32406	Ø1.90mm Jewellery Drill	EACH	£3.25
D32407	Ø2.00mm Jewellery Drill	EACH	£3.25
D2477	Ø2.10mm Jewellery Drill	EACH	£3.25
D32408	Ø2.20mm Jewellery Drill	EACH	£3.25
D32409	Ø2.30mm Jewellery Drill	EACH	£3.25

Price breaks available, see website

**PEARL DRILL BITS**



Something's to know about Pearls...

The shape of a pearl is divided into three categories: spherical, symmetrical, and baroque.

The rarest and most valuable is the spherical or round pearl. These are judged on their degree of "sphericity" or roundness. While fine pearls that are perfectly round are extremely rare, the closer a pearl comes to being perfectly round, the more expensive it will be. Pearls with shapes such as teardrop or pear-shape are symmetrical pearls, and are judged on proportioning, outline, and good symmetry; that is, whether they have a nice, pleasing, and well-balanced shape.

Any strand of pearls should be well matched for shape, and when worn give the appearance of uniformity. Terms such as semi-round and semi-baroque are also used.

These are terms applied to pearls that are "out of round" but not so much that their irregular shape is interesting, or distinctive. These cost much less than other shapes.

Symmetrical pearls are less expensive than round pearls-although there are some exceptions-but much more expensive than baroque pearls, which are irregularly shaped pearls.

To see more information about pearls we supply a highly informative book called *The book of Pearls by Kunz and Stevenson (CODE C9273)*

- Pearl Drills with a centre point and two side's cutting edges are the most popular drills to set and drill pearls and is ideal for setting flat backed pearls.
- Using conventional steel burrs can be problematic when drilling flat backed pearls, making dedicated pearl drills easily and essential to do the most complex job.
- Once you have marked the setting location for the pearl(s) touch or push the centre point of the burr on to the setting to be drilled and commence burring clockwise and the drill will remain in is location whilst completing the perfect hole. This virtually eradicates any possibility of the drill moving/running away from the job. The two side cutting edges provides a precision horizontal cutting edge thus opening out the mount evenly.

Cousins Material House supplies a whole range of pearl drills and accessories which cater for all pearl setting, stringing, drilling, storage, etc.

Set your various shapes and sizes of pearls with our array of steel burr range.

**Pearl Drills, A\*F Swiss (Triangular)**

A\*F Swiss

These triangular drills, designed specially for pearl drilling are the result of many years of research and experience. In high speed steel (HSS).

- Specially designed
- Triangular
- High Speed Steel (HSS)
- Double ended
- Length 50mm Approx.

Sizes: Ø0.60, 0.70, 0.80, 0.90, 1.00, 1.10, 1.20, 1.40mm

Code	Description	UOM	Price
D47281	Ø0.60mm Triangular Pearl Drill	EACH	£5.95
D47282	Ø0.70mm Triangular Pearl Drill	EACH	£5.95
D47283	Ø0.80mm Triangular Pearl Drill	EACH	£5.95
D47284	Ø0.90mm Triangular Pearl Drill	EACH	£5.95
D47285	Ø1.00mm Triangular Pearl Drill	EACH	£5.95

D47286	Ø1.10mm Triangular Pearl Drill	EACH	£5.95
D47287	Ø1.20mm Triangular Pearl Drill	EACH	£5.95
D47288	Ø1.40mm Triangular Pearl Drill	EACH	£5.95

**Pearl Drills, A\*F Swiss (Shank Ø3mm)**



A\*F Swiss

For piercing and to drill setting holes for pearls and other round and half round stones. Specially designed to prevent the chipping of the nacre. Shank diameter Ø3.00mm.

Drill Set contains: Ø1.05, 1.20, 1.25, 1.45, 1.65, 1.85, 2.05, 2.25, 2.40, 2.65, 2.85, 3.00mm

- Popular sizes available individually
- Shank size Ø3.00mm

Code	Description	UOM	Price
D47289	Pearl Drill Set, A*F Swiss	PACK*12	£74.95
D47290	Ø1.05mm Pearl Drill	EACH	£9.75
D47291	Ø1.20mm Pearl Drill	EACH	£9.75
D47292	Ø1.25mm Pearl Drill	EACH	£9.75
D47293	Ø1.45mm Pearl Drill	EACH	£9.75
D47294	Ø1.65mm Pearl Drill	EACH	£9.75
D47295	Ø1.85mm Pearl Drill	EACH	£9.75
D47296	Ø2.05mm Pearl Drill	EACH	£9.75
D47297	Ø2.25mm Pearl Drill	EACH	£9.75
D47298	Ø2.40mm Pearl Drill	EACH	£9.75
D47299	Ø2.65mm Pearl Drill	EACH	£9.75
D47300	Ø2.85mm Pearl Drill	EACH	£9.75
D47301	Ø3.00mm Pearl Drill	EACH	£9.75

**Pearl Drills, A\*F Swiss (Tungsten)**

A\*F Swiss

Special drills in "Tool Steel" or "Tungsten Carbide" that have a unique cutting face that scribes the nacre of the pearls surface to avoid chipping.

- Shank Ø2.35mm

Code	Description	UOM	Price
D47314	Ø0.90mm Tungsten Carbide Pearl Drill	EACH	£8.95
D47315	Ø1.00mm Tungsten Carbide Pearl Drill	EACH	£8.95
D47312	Ø2.10mm Tool Steel Pearl Drill	EACH	£6.50
D47313	Ø2.30mm Tool Steel Pearl Drill	EACH	£6.50

**Cup & Peg Pearl Mounts**

See Page 35



**Pearl Drills, Busch 417**

Busch 417

Specially designed to prevent the chipping of the nacre when drilling or enlarging existing holes

- Shank Ø2.35mm
- Sizes: Ø0.90, 1.00, 1.20, 1.40mm



Code	Description	UOM	Price
<b>B417009</b>	Ø0.90mm Busch Pearl Drill	EACH	<b>£3.95</b>
<b>B417010</b>	Ø1.00mm Busch Pearl Drill	EACH	<b>£3.95</b>
<b>B417012</b>	Ø1.20mm Busch Pearl Drill	EACH	<b>£3.95</b>
<b>B417014</b>	Ø1.40mm Busch Pearl Drill	EACH	<b>£3.95</b>

Price breaks available, see website

**Tungsten Carbide Drills, A\*F Swiss**



A\*F Swiss - Tungsten Jewellery Drills are a world favourite.

Finest quality, Swiss made for reliability, long life accuracy and satisfaction guaranteed. Very popular with jewellers, silversmiths, watch makers/repairers, light engineers, model makers plastic fabricators and for arts and crafts.

100% hard metal for drilling tough materials including glass, ceramic, bone, jade, mother-of-pearl as well as various metals. Ideal for use with micro motors and are very popular for quick release headpieces as changing your drill sizes are fast and easy.

- Sizes Ø0.50, 0.60, 0.70, 0.80, 0.90, 1.00, 1.10, 1.20, 1.30 and 1.40mm
- Set contains all sizes from Ø0.50mm to Ø1.40mm
- Length of whole drill 45mm
- Drilling length 12mm
- Shank body size Ø2.35mm or 3/32"

- Equivalent:
- Busch 203HSS
  - Maillefer 58MD

Code	Description	UOM	Price
<b>D0441</b>	Tungsten Carbide Drills Set	PACK*10	<b>£69.95</b>
<b>D0441A</b>	Ø0.50mm Tungsten Drill	EACH	<b>£6.85</b>
<b>D0441B</b>	Ø0.60mm Tungsten Drill	EACH	<b>£6.85</b>
<b>D0441C</b>	Ø0.70mm Tungsten Drill	EACH	<b>£6.85</b>
<b>D4325</b>	Ø0.80mm Tungsten Drill	EACH	<b>£6.85</b>
<b>D4327</b>	Ø0.90mm Tungsten Drill	EACH	<b>£6.85</b>
<b>D4329</b>	Ø1.00mm Tungsten Drill	EACH	<b>£6.85</b>
<b>D4331</b>	Ø1.10mm Tungsten Drill	EACH	<b>£6.85</b>
<b>D4333</b>	Ø1.20mm Tungsten Drill	EACH	<b>£6.85</b>
<b>D47270</b>	Ø1.30mm Tungsten Drill	EACH	<b>£6.85</b>
<b>D47271</b>	Ø1.40mm Tungsten Drill	EACH	<b>£6.85</b>
<b>D47272</b>	Ø1.50mm Tungsten Drill	EACH	<b>£6.85</b>
<b>D47273</b>	Ø1.60mm Tungsten Drill	EACH	<b>£6.85</b>
<b>D47274</b>	Ø1.70mm Tungsten Drill	EACH	<b>£6.85</b>
<b>D47275</b>	Ø1.80mm Tungsten Drill	EACH	<b>£6.85</b>
<b>D47276</b>	Ø1.90mm Tungsten Drill	EACH	<b>£6.85</b>
<b>D47277</b>	Ø2.00mm Tungsten Drill	EACH	<b>£6.85</b>
<b>D47278</b>	Ø2.10mm Tungsten Drill	EACH	<b>£6.85</b>
<b>D47279</b>	Ø2.20mm Tungsten Drill	EACH	<b>£6.85</b>
<b>D47280</b>	Ø2.30mm Tungsten Drill	EACH	<b>£6.85</b>

Price breaks available, see website

**ESSENCE JARS & GEMSTONE WASHING CUPS**

Essence jars are a valuable storage container for watch fluids that are prone to evaporating.

- Various sizes and styles available to suit you and your workshop.
- Essence jars are regarded as being essential for the watchmaker/repairer as fluids are maintained and not wasted.
- All our ranges consist of precise grounded glass lids and lips, giving you a perfect seal.

Also, diamond & gemstone washing cups are the perfect way to clean your precious stones in alcohol or any cleaning solution without the fear of losing them.

**Essence Jars**



- Ø80mm
- Height 40mm
- Cover with glass knob
- Value item
- Lid or jar may need grinding to ensure perfect seal

Code	Description	UOM	Price
<b>A42916</b>	Ø80mm Essence Jar	EACH	<b>£4.25</b>

**Essence Jars, AF Swiss**



- A\*F Swiss
- Ø75mm
- Height 50mm
- Cover with knob

Code	Description	UOM	Price
<b>E31402</b>	Ø75mm Essence Jar, A*F Swiss	EACH	<b>£23.95</b>

**TUNGSTEN CARBIDE DRILL BITS**

A\*F Swiss Tungsten Jewellery Drills are a world favourite.

Finest quality in 100% hardened steel for reliability, long life accuracy and satisfaction guaranteed

- Sizes Ø0.50, 0.60, 0.70, 0.80, 0.90, 1.00, 1.10, 1.20, 1.30 and 1.40mm (also available in single pieces see code D0441a to D4333)
- shanked body size Ø2.35mm or 3/32"
- are very popular for jewellers, silversmiths, watch makers/repairers, light engineers, model makers plastic fabricators and for arts and crafts
- can be used on a whole range of materials such as gold, silver, platinum, copper, brass, pewter, bronze and aluminium
- used on micro motors, and quick release rotary hand pieces
- shanked drill are very popular for quick release headpieces as changing your drill sizes are fast and easy
- ideal for drilling tough materials such as glass, ceramic, bone, jade & mother of pearl.

Recommended rotary machines

- Jewellers Kit & No20 "Quick Release" Handpiece: K2220CE
- Foredom High Speed Rotary Micromotor Kit K1070CE
- Saeshin (Korea) Micromotor & Handpiece M9768

Size :  
Length of whole drill 45mm  
Drilling length 12mm



**WORLDWIDE DELIVERY**

Gravers for Pearl Setting

See Page 904



Drill Press

See Page 699



Proxon Precision Bench Drill

See Page 659



**Essence Jars, Bergeon Swiss**



- Bergeon 5445
- Cover with glass knob
- Perfectly ground lid and jar ensuring near zero evaporation
- Multiple sizes available

Dimensions:

- Diameter Ø x Height

Code	Description	UOM	Price
E39558	Ø35 x 30mm Essence Jar, Bergeon Swiss	EACH	£25.50
E39559	Ø60 x 35mm Essence Jar, Bergeon Swiss	EACH	£36.95
E39560	Ø80 x 35mm Essence Jar, Bergeon Swiss	EACH	£49.95

**Essence Jars, Bergeon Swiss with Metal Knob**



- Bergeon 30513
- Cover with metal knob
- Multiple sizes available

Dimensions:

- Diameter Ø x Height

Code	Description	UOM	Price
E0529	Ø60 x 50mm Essence Jar, Bergeon Swiss	EACH	£58.95
E0531	Ø100 x 55mm Essence Jar, Bergeon Swiss	EACH	£79.95

**Essence Jars, Swisotech**



- Swisotec
- Cover with glass knob
- Perfectly ground lid and jar ensuring near zero evaporation
- Multiple sizes available
- Made in Switzerland

Dimensions:

- Diameter Ø x Height

Code	Description	UOM	Price
B44198	Ø50 x 40mm Essence Jar, Swisotech	EACH	£23.95
B44199	Ø80 x 50mm Essence Jar, Swisotech	EACH	£26.95



**Essence Jars, Plastic**



- Plastic
- Ø70mm
- Height 40mm
- Cover with knob
- Inexpensive if lost or damaged
- Made in India

Code	Description	UOM	Price
B39343	Ø70mm Essene Jar, Indian	EACH	£1.95

**Diamond & Gemstone Washing Cup**



Diamond & gemstone washing cups are the perfect way to clean your precious stones in alcohol or any cleaning solution without the fear of losing them.

- Separate, removable sieve compartment prevents stones from swirling loose in cleaning solution
- Glass jars with screw on lids
- Small or large

G39601:

- Overall size - Ø60 x 65mm
- Cleaning basket - Ø40 x 50mm
- Weight - 300g

G39600:

- Overall size - Ø90 x 110mm
- Cleaning basket - Ø70 x 95mm
- Weight - 600g

Code	Description	UOM	Price
G39601	Ø60mm Diamond & Gemstone Washing Cup	EACH	£6.95
G39600	Ø90mm Diamond & Gemstone Washing Cup	EACH	£9.95



**EYEGASSES, MAGNIFIERS, LOUPES & LOUPE CHAINS**

**BINOCULAR MAGNIFIERS**

Perhaps you know the problem all too well... You need to use both hands when you're working with delicate components and could do with a third hand to hold the magnifying glass so that you can see the small details. With our binocular magnifiers you can keep both hands free because these magnifying spectacles are worn just like normal glasses. Ideal for:

- Jewellery making/repair
- Watch maker's services and repair
- Model making
- Handicrafts
- Reading
- Painting
- Restoration work
- Soldering
- Testing/inspection work
- Beauticians

**A\*F Swiss Binocular Magnifiers**



A\*F Swiss

- A\*F 176.582
- Focal length 4"
- Magnification x2.5

Code	Description	UOM	Price
E0540	Binocular Magifier Clip On	EACH	£18.25



**Optivisors**

See Page 937



**Light Tec Binocular Magnifiers**



Light Tec

- Lightweight design
- 3 different strength lenses: x1.5, x2.5 & x3.5
- LED bulb for giving you the perfect work environment

Code	Description	UOM	Price
G35669	Binocular Magnifiers with L.E.D	EACH	£6.95

**Light Tec, Superior Binocular Magnifiers**

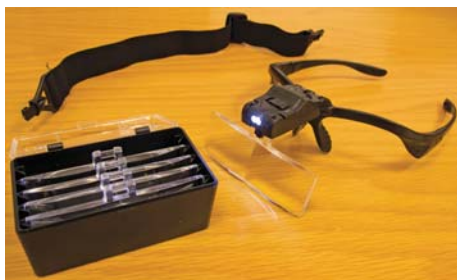

Light Tec - Superior

- Sturdy frame design
- 5 different strength lenses: x1, x1.5, x2, x2.5 & x3.5
- Lenses are 85 x 30mm
- 2 removable LED bulbs for giving you the perfect work environment
- Elastic headband option which can replace the frame arms for a different feel

Code	Description	UOM	Price
G37240	Binocular Magnifiers with L.E.D Light - 5 Lens	EACH	£11.95

**Eschenbach Max Detail Binocular Magnifiers**



Eschenbach - Germany

Optics Max Detail - the glasses for demanding, detailed work. Made in Germany

For 20 years the Eschenbach Optic group has developed and produced customer specific high precision polymer lenses and silicone optics. Made with ultra-precision machining and modern precision moulding machines in a temperature controlled production environment, the Eschenbach Optic group

offers its customers optics at the highest quality standards.

Features:

- Very simple to use due to large PD tolerance range
- Supplied with attachable temple ends which prevent the spectacles from slipping down the nose
- Excellent image quality due to large focusing range
- Also suitable for spectacle wearers as they have right and left dioptre compensation which can be separately adjusted
- Adjustable temples: Temples with metal wire inserts - to allow the temple to be shaped to provide a good fit

Technical information:

- Magnification 2.0 x
- Weight: 49g
- PD tolerance range 60 - 68 mm (PD = pupillary distance, the distance between your pupils)
- Distance of use: Approx. 40cm
- Visual field 10°, 15 cm / 40 cm
- Dioptre compensation: ±3.0 dpt, right/left can be separately adjusted, cylinder correction is not possible
- The manufacturer states that the universal fitting and moulding of these glasses to the individuals head is achieved by pressing in the middle of the arms once the glasses are on your head. This ensures that they will universally fit to any individuals head.

Code	Description	UOM	Price
O35293	Binocular Magnifiers, Adjustable Lens	EACH	£69.95

**EYEGLASS HOLDERS**

**Eyeglass Holder, Indian**

- Steel band Plastic coated
- Moveable into any position
- Adjustable to any eye glass



Code	Description	UOM	Price
E31912	Eyeglass Holder, Indian	EACH	£1.95

**Eyeglass Holder, Bergeon 5461**

- Stainless steel wire
- Economical version of Bergeon 2405 (E0567)
- Adjustable to any eye glass.



Code	Description	UOM	Price
E0568	Eyeglass Holder, Bergeon 5461	EACH	£3.65

**EYEGLASS WATCHMAKERS LOUPES**

**Watchmakers Loupes, USA**

Donegan - Made in USA

- Convenient hands free magnification for spectacle wearers
- Graduated positional cams secure to glasses frame arm, with lens swivelling away when not needed
- Converts to left or right eye and includes fixing instructions
- Choice of strengths
- Made in USA

Specifications:

- Single or double lens
- Mag x2.8, x4, x12

**No.2½ (Mag x4) Loupe**



Donegan - Made in USA

- No.2½ (Mag x4) Loupe
- Single lens

Code	Description	UOM	Price
E9605	No.2½ (Mag x4) Loupe	EACH	£22.95

**No.3½ (Mag x2.8) Loupe**



Donegan - Made in USA

- No.3½ (Mag x2.8) Loupe
- Single lens

Code	Description	UOM	Price
E9606	No.3½ (Mag x2.8) Loupe	EACH	£19.95

**Double Lens (Mag x12) Loupe**



Donegan - Made in USA

- This double lens version can give x12 mag combined.
- Made in USA.

Code	Description	UOM	Price
E9607	Double Lens (Mag x12) Loupe	EACH	£27.95

**Watchmakers Loupes, Cousins**



- Universal for left or right eye fitting
- Traditional Watchmakers Clip On Loupe

Code	Description	UOM	Price
E34945	No.2 (Mag x5) Eyeglass	EACH	£2.95
E34946	No.2.5 (Mag x4) Eyeglass	EACH	£2.95
E34947	No.3 (Mag x3.5) Eyeglass	EACH	£2.95
E34948	No.3.5 (Mag x3) Eyeglass	EACH	£2.95
E34949	No.4 (Mag x2.5) Eyeglass	EACH	£2.95

**OVER 130,000 DIFFERENT ITEMS**

**Watchmakers Loupes, Cousins - Double**



- Universal for left or right eye fitting
- Traditional watchmakers clip on double loupe
- x3.3 & x5 magnification

Code	Description	UOM	Price
E39437	3.3x & 5x Eyeglass	EACH	£3.95

**EYEGASSES - CLIP ON SPECTACLES**

- Size 1.0" (1) - Magnification 10x actual - eye to object 1" inch (25mm)
- Size 1.5" (1½) - Magnification 6.7x actual - eye to object 1½" inch (38mm)
- Size 2.0" (1) - Magnification 5x actual - eye to object 2" inch (51mm)
- Size 2.5" (1½) - Magnification 4x actual - eye to object 2½" inch (64mm)
- Size 3.0" (1) - Magnification 3.3x actual - eye to object 3" inch (76mm)
- Size 3.5" (1½) - Magnification 2.8x actual - eye to object 3½" inch (89mm)
- Size 4.0" (1) - Magnification 2.5x actual - eye to object 4" inch (102mm)

Example: Bergeon 2611-2.0" eyeglass will provide 5 x magnification at 2" (51mm) distance

**A\*F Swiss, Clip On**

- A\*F 17620
- Ideal for low set spectacle arms
- Universal left or right eye fitting
- Number is the focal length in inches



Code	Description	UOM	Price
E0542	No.1.5 (Mag x6.7) Eyeglass	EACH	£11.75
E0543	No.2 (Mag x5) Eyeglass	EACH	£11.75
E0544	No.2.5 (Mag x4) Eyeglass	EACH	£11.75
E0545	No.3 (Mag x3.3) Eyeglass	EACH	£11.75
E0546	No.3.5 (Mag x2.8) Eyeglass	EACH	£11.75
E0547	No.4 (Mag x2.5) Eyeglass	EACH	£11.75

**ARY, Left Eye Clip On**

- Sleeved spring clip cleverly holds to spectacle frame with lens in path of vision – pivots away when not needed
- Eyeglass for spectacles, ARY - STANDARD
- Extra light
- Easily adjustable to any frame. Contact parts are covered with rubber, 4 holding clamps
- Centring adjustment
- With screw ring



• Number is the focal length in inches

Code	Description	UOM	Price
E0537	No.1 (Mag x10) Eyeglass, Left	EACH	£72.50
E0538	No.1.5 (Mag x6.7) Eyeglass, Left	EACH	£72.50
E7311	No.2 (Mag x5) Eyeglass, Left	EACH	£72.50
E7312	No.2.5 (Mag x4) Eyeglass, Left	EACH	£72.50
E7313	No.3 (Mag x3.3) Eyeglass, Left	EACH	£72.50
E7314	No.3.5 (Mag x2.8) Eyeglass, Left	EACH	£72.50
E7315	No.4 (Mag x2.5) Eyeglass, Left	EACH	£72.50

**ARY, Right Eye Clip On**

- Sleeved spring clip cleverly holds to spectacle frame with lens in path of vision – pivots away when not needed.
- Eyeglass for spectacles, ARY - STANDARD
- Extra light
- Easily adjustable to any frame. Contact parts are covered with rubber, 4 holding clamps.
- Centring adjustment.
- With screw ring.



Code	Description	UOM	Price
E0535	No.1 (Mag x10) Eyeglass, Right	EACH	£72.50
E0536	No.1.5 (Mag x6.7) Eyeglass, Right	EACH	£72.50
E7306	No.2 (Mag x5) Eyeglass, Right	EACH	£72.50
E7307	No.2.5 (Mag x4) Eyeglass, Right	EACH	£72.50
E7308	No.3 (Mag x3.3) Eyeglass, Right	EACH	£72.50
E7309	No.3.5 (Mag x2.8) Eyeglass, Right	EACH	£72.50
E7310	No.4 (Mag x2.5) Eyeglass, Right	EACH	£72.50

**ARY, Right Eye Clip On (large frames)**

- For large spectacle frames
- Eyeglass for spectacles, ARY - MAXI
- Extra light
- Easily adjustable to any frame.
- Contact parts are covered with rubber, 4 holding clamps.
- Centring adjustment.
- With screw ring.



Code	Description	UOM	Price
E7316	No.3 (Mag x3.3) Eyeglass, Right	EACH	£63.10

**ARY Additional Eyeglass**

- Bergeon 5664
- 6.5x magnification
- For either left or right eyeglasses



By adding this simple press fit multiplier lens the magnification of an Ary will be boosted by 6½ times.

Code	Description	UOM	Price
E0539	ARY Additional Eyeglass	EACH	£12.50

**ARY 1.5 Lens (x6.7)**

- ARY Eyeglass
- Replacement Lens
- 1.5 (x6.7)
- Left or Right



Code	Description	UOM	Price
E7317A	ARY 1.5 Lens (x6.7)	EACH	£24.95

**ARY Eyeglass Replacement 3.0 Lens**



- ARY Eyeglass
- Replacement Lens
- 3.0 (x3.3)
- Left or Right

Code	Description	UOM	Price
E7317B	ARY Eyeglass Replacement 3.0 Lens	EACH	£24.95

**ARY Spring Clip, Right Hand**

- Replacement clip only
- Right Hand
- Any magnification
- Bergeon 1492AD



Code	Description	UOM	Price
E8781	ARY Spring Clip, Right Hand	EACH	£41.50

**ARY Spring Clip, Left Hand**

- Replacement clip only
- Left Hand
- Any magnification
- Bergeon 1492AG



Code	Description	UOM	Price
E20012	ARY Spring Clip, Left Hand	EACH	£41.50

**Cousins Clip On**



- Universal for left or right eye fitting
- Choice of 5 different strengths

Code	Description	UOM	Price
E34940	No.2 (Mag x5) Eyeglass	EACH	£2.95
E34941	No.2.5 (Mag x4) Eyeglass	EACH	£2.95
E34942	No.3 (Mag x3.3) Eyeglass	EACH	£2.95
E34943	No.3.5 (Mag x2.8) Eyeglass	EACH	£2.95
E34944	No.4 (Mag x2.5) Eyeglass	EACH	£2.95

**Spectacle Screws**



See Page: 257



**Cousins, Clip On (Anodised)**



- Universal for left or right eye fitting
- Metal anodised
- Far East

Code	Description	UOM	Price
E36693	Mag x4 Anodised Eyeglass	EACH	£7.95
E35127	Mag x15 Anodised Eyeglass	EACH	£7.95

**EYEGASSES - DOUBLE LENS**

Double Lens Eyeglasses for extra strong close up viewing of items with high magnification x10, x12, x15 & x20

- Bergeon
- Cousins
- Seitz

**Bergeon x12 Magnification**

- Bergeon 1458A-12
- x12 Magnification
- Extra strong eyeglass for close and high magnification.



Code	Description	UOM	Price
E0559	Double Lens x12 Magnification, Bergeon	EACH	£11.75

**Bergeon x15 Magnification**

- Bergeon 1458A-15
- x15 Magnification
- Extra strong eyeglass for close and high magnification.



Code	Description	UOM	Price
E0560	Double Lens x15 Magnification, Bergeon	EACH	£11.75

**Cousins x12 Magnification**

- x12 Magnification
- Twin lens inspection loupes



Code	Description	UOM	Price
E9227	Double Lens x12 Magnification, Cousins	EACH	£1.95

**Cousins x15 Magnification**

- x15 Magnification
- Twin lens inspection loupes



Code	Description	UOM	Price
E9228	Double Lens x15 Magnification, Cousins	EACH	£1.95

**Cousins x20 Magnification**

- x20 Magnification
- Twin lens inspection loupes



Code	Description	UOM	Price
E39431	Double Lens x20 Magnification, Cousins	EACH	£1.35

**Seitz x10 Magnification**

- Seitz loupe
- Bergeon 30654A
- x10 Magnification
- Top quality lens with high magnification
- Two lenses
- Blue tinted lenses with screw ring



The inside of the frame is finely threaded and permits the adjustment to your sight.

Code	Description	UOM	Price
E0551	Double Lens x10 Magnification, Seitz	EACH	£85.95

**Seitz x20 Magnification**

- Seitz loupe
- Bergeon 30654
- x20 Magnification
- Top quality lens with high magnification
- Two lenses
- Blue tinted lenses with screw ring



The inside of the frame is finely threaded and permits the adjustment to your sight.

Code	Description	UOM	Price
E0552	Double Lens x20 Magnification, Seitz	EACH	£94.95

**EYEGASSES - REGULAR**

- Size 1.0" (1) - Magnification 10x actual - eye to object 1" inch (25mm)
- Size 1.5" (1½) - Magnification 6.7x actual - eye to object 1½" inch (38mm)
- Size 2.0" (1) - Magnification 5x actual - eye to object 2" inch (51mm)
- Size 2.5" (1½) - Magnification 4x actual - eye to object 2½" inch (64mm)
- Size 3.0" (1) - Magnification 3.3x actual - eye to object 3" inch (76mm)
- Size 3.5" (1½) - Magnification 2.8x actual - eye to object 3½" inch (89mm)
- Size 4.0" (1) - Magnification 2.5x actual - eye to object 4" inch (102mm)

Example: Bergeon 2611-2.0" eyeglass will provide 5 x magnification at 2" (51mm) distance

**A\*F Swiss, Standard**



Eyeglasses - A\*F Swiss

- A\*F Swiss
- Loupes for watchmakers
- "Mag" = Magnification
- Mineral glass lens

Code	Description	UOM	Price
E34909	No.1.5 (Mag x6.7) Eyeglass	EACH	£6.85
E34910	No.2 (Mag x5) Eyeglass	EACH	£6.85
E34911	No.2.5 (Mag x4) Eyeglass	EACH	£6.85
E34912	No.3 (Mag x3.3) Eyeglass	EACH	£6.85
E34913	No.3.5 (Mag x2.8) Eyeglass	EACH	£6.85
E34914	No.4.0 (Mag x2.5) Eyeglass	EACH	£6.85

**Diamond & Gemstone Scoops**

See Page 1000



**A\*F Swiss, Screw Rimmed**

Eyeglasses - A\*F Swiss - Screw Rimmed

- A\*F Swiss
- Excellent quality loupes for watchmakers
- Easily removable lens for cleaning with external screw rim
- Distortion free lens
- "Mag" = Magnification
- Mineral glass lens



Code	Description	UOM	Price
E0558	No.4 (Mag x2.5) Eyeglass	EACH	£18.75

**Bergeon, Standard**

Eyeglasses - Bergeon Swiss

- Bergeon 4422
- High quality loupes with lens retained by internal ring
- "Mag" = Magnification
- Mineral glass lens



Code	Description	UOM	Price
E0561	No.1.5 (Mag x6.7) Eyeglass	EACH	£7.75
E0562	No.2 (Mag x5) Eyeglass	EACH	£7.75
E7323	No.2.5 (Mag x4) Eyeglass	EACH	£7.75
E5012	No.3 (Mag x3.3) Eyeglass	EACH	£7.75
E7324	No.3.5 (Mag x2.8) Eyeglass	EACH	£7.75
E5013	No.4 (Mag x2.5) Eyeglass	EACH	£7.75

**Bergeon, Aplanatic**

Eyeglasses - Bergeon Swiss - Aplanatic

- Bergeon 4902
- Optically / Spectrally corrected for jewellers seeking minimum aberration
- "Mag" = Magnification
- Mineral glass lens



Code	Description	UOM	Price
E0563	No.1 (Mag x10) Aplanatic Eyeglass	EACH	£27.50
E0565	No.1.5 (Mag x6.7) Aplanatic Eyeglass	EACH	£27.50
E0564	No.2 (Mag x5) Aplanatic Eyeglass	EACH	£27.50
E7325	No.2.5 (Mag x4) Aplanatic Eyeglass	EACH	£27.50
E7326	No.3 (Mag x3.3) Aplanatic Eyeglass	EACH	£27.50
E7327	No.4 (Mag x2.5) Aplanatic Eyeglass	EACH	£27.50

**Bergeon, Screw Rimmed**



Eyeglasses - Bergeon Swiss - Screw Rimmed

- Bergeon 2611-N & 2611-B
- Black or white
- High quality loupe
- Easily removable lens for cleaning with external screw rim
- "Mag" = Magnification

• Mineral glass lens

Code	Description	UOM	Price
E2869	Black, No.1.5 (Mag x6.7) Eyeglass	EACH	£11.75
E2870	Black, No.2 (Mag x5) Eyeglass	EACH	£11.75
E2871	Black, No.2.5 (Mag x4) Eyeglass	EACH	£11.75
E2872	Black, No.3 (Mag x3.3) Eyeglass	EACH	£11.75
E2873	Black, No.3.5 (Mag x2.8) Eyeglass	EACH	£11.75
E2874	Black, No.4 (Mag x2.5) Eyeglass	EACH	£11.75
E40502	White, No.1.5 (Mag x6.7) Eyeglass	EACH	£11.75
E40503	White, No.2 (Mag x5) Eyeglass	EACH	£11.75
E40504	White, No.2.5 (Mag x4) Eyeglass	EACH	£11.75
E40505	White, No.3 (Mag x3.3) Eyeglass	EACH	£11.75
E40506	White, No.3.5 (Mag x2.8) Eyeglass	EACH	£11.75
E40507	White, No.4 (Mag x2.5) Eyeglass	EACH	£11.75

**Bergeon, Sight Opening**



Eyeglasses - Bergeon Swiss - Sight Opening

- Bergeon 2611-TN & 2611-TB
- Black or white
- Sight opening allows natural light into the viewing space
- High quality loupe
- Easily removable lens for cleaning with external screw rim
- "Mag" = Magnification
- Mineral glass lens

Code	Description	UOM	Price
E40490	Black, No.1.5 (Mag x6.7) Eyeglass	EACH	£13.85
E40491	Black, No.2 (Mag x5) Eyeglass	EACH	£13.85
E40492	Black, No.2.5 (Mag x4) Eyeglass	EACH	£13.85
E40493	Black, No.3 (Mag x3.3) Eyeglass	EACH	£13.85
E40494	Black, No.3.5 (Mag x2.8) Eyeglass	EACH	£13.85
E40495	Black, No.4 (Mag x2.5) Eyeglass	EACH	£13.85
E40496	White, No.1.5 (Mag x6.7) Eyeglass	EACH	£13.85
E40497	White, No.2 (Mag x5) Eyeglass	EACH	£13.85
E40498	White, No.2.5 (Mag x4) Eyeglass	EACH	£13.85
E40499	White, No.3 (Mag x3.3) Eyeglass	EACH	£13.85
E40500	White, No.3.5 (Mag x2.8) Eyeglass	EACH	£13.85
E40501	White, No.4 (Mag x2.5) Eyeglass	EACH	£13.85

**Cousins, Standard**



Eyeglasses - Cousins

- General purpose
- Ground glass lens
- Comfortable plastic body
- Inexpensive to replace if lost or damaged
- "Mag" = Magnification
- Mineral glass lens

Set contains:

- 2.5x - 3x - 5x - 7x - 10x

Code	Description	UOM	Price
E39432	Eyeglass Set	PACK*5	£3.95
E36244	No.1 (Mag x10) Eyeglass	EACH	£0.95
E36245	No.1.5 (Mag x6.7) Eyeglass	EACH	£0.95

E36246	No.2 (Mag x5) Eyeglass	EACH	£0.95
E36247	No.2.5 (Mag x4) Eyeglass	EACH	£0.95
E36248	No.3 (Mag x3.5) Eyeglass	EACH	£0.95
E8904	No.3.5 (Mag x2.8) Eyeglass	EACH	£0.95
E36250	No.4 (Mag x2.5) Eyeglass	EACH	£0.95
Price breaks available, see website			

**Cousins, Aluminium**



Eyeglasses - Cousins - Aluminium

- General purpose
- Inexpensive to replace if lost or damaged
- Cool Aluminium body
- "Mag" = Magnification
- Mineral glass lens

Code	Description	UOM	Price
E34926	No. 1 (Mag x10) Eyeglass	EACH	£1.15
E34927	No.1.5 (Mag x6.7) Eyeglass	EACH	£1.15
E34928	No.2 (Mag x5) Eyeglass	EACH	£1.15
E34929	No. 2.5 (Mag x 4) Eyeglass	EACH	£1.15
E34930	No.3 (Mag x3.5) Eyeglass	EACH	£1.15
E34931	No. 3.5 (Mag x2.8) Eyeglass	EACH	£1.15
E34932	No. 4 (Mag x2.5) Eyeglass	EACH	£1.15

**Cousins, Anodised**



Eyeglasses - Cousins - Anodised

- Inexpensive Swiss Alternative
- Classic Shape
- Aluminium Screw Rim
- "Mag" = Magnification
- Mineral glass lens

Code	Description	UOM	Price
E35124	Mag x3 Anodised Eyeglass	EACH	£8.50
E36694	Mag x4 Anodised Eyeglass	EACH	£8.50
E35125	Mag x5 Anodised Eyeglass	EACH	£8.50
E35126	Mag x10 Anodised Eyeglass	EACH	£8.50

**Cousins, Collapsible**



Eyeglasses - Cousins - Collapsible

- General purpose
- Inexpensive to replace if lost or damaged
- Collapsible, easy to transport
- Supplied in plastic carry case
- Ø23mm lens
- Collapses to Ø38 x 11mm

# EYEGASSES, MAGNIFIERS, LOUPES & LOUPE CHAINS

- Colours may vary
- Mineral glass lens

Code	Description	UOM	Price
E39433	2x Collapsible Eyeglass	EACH	£1.75
E39434	2.5x Collapsible Eyeglass	EACH	£1.75
E39435	3x Collapsible Eyeglass	EACH	£1.75
E39436	3.5x Collapsible Eyeglass	EACH	£1.75

## Cousins, LED

Eyeglasses - Cousins - with LED

- 6x, 10x or 15x magnification
- General purpose
- Inexpensive to replace if lost or damaged
- With white LED light
- Ø20mm lens
- Mineral glass lens



Code	Description	UOM	Price
E40254	6x Eyeglass with LED	EACH	£2.25
E40255	10x Eyeglass with LED	EACH	£2.25
E39430	15x Eyeglass with LED	EACH	£2.95

## Cousins, Screw Rimmed



Eyeglasses - Cousins - Screw Rimmed

- General purpose
- Inexpensive to replace if lost or damaged
- Comfortable plastic body
- Easily removable lens for cleaning with external aluminium style screw rim
- Mineral glass lens
- Mineral glass lens

Code	Description	UOM	Price
E34933	No.1 (Mag x10) Eyeglass	EACH	£1.45
E34934	No.1.5 (Mag x6.7) Eyeglass	EACH	£1.45
E34935	No.2 (Mag x5) Eyeglass	EACH	£1.45
E34936	No.2.5 (Mag x4) Eyeglass	EACH	£1.45
E34937	No.3 (Mag x3.5) Eyeglass	EACH	£1.45
E34938	No.3.5 (Mag x2.8) Eyeglass	EACH	£1.45
E34939	No.4 (Mag x2.5) Eyeglass	EACH	£1.45

## Cousins, with Plastic Headband



Eyeglasses - Cousins - with Headband

- General purpose
- Inexpensive to replace if lost or damaged
- Comfortable plastic body
- Supplied with plastic headband
- Headband consists of high tension wire with a plastic coating for extra comfort
- Mineral glass lens

Code	Description	UOM	Price
E45821	5x Eyeglass with Headband	EACH	£2.25
E45822	10x Eyeglass with Headband	EACH	£2.25

## Cousins, Wood



Eyeglasses - Cousins - Wood

- Rose Wood
- Steam Beech
- Ø18.5mm Lens
- Smooth & quality finish
- Stylish & unusual
- Unbeatable value
- "Mag" = Magnification
- Mineral glass lens

Code	Description	UOM	Price
E37144	No.1 (Mag x10) Rosewood	EACH	£5.95
E37145	No.1.5 (Mag x7) Rosewood	EACH	£5.95
E37146	No.2 (Mag x5) Rosewood	EACH	£5.95
E37147	No.2.5 (Mag x4) Rosewood	EACH	£5.95
E37148	No.3 (Mag x3.5) Rosewood	EACH	£5.95
E37149	No.3.5 (Mag x3) Rosewood	EACH	£5.95
E37150	No.4 (Mag x2.5) Rosewood	EACH	£5.95
E37151	No.4.5 (Mag x2) Rosewood	EACH	£5.95
E37152	No.1 (Mag x10) Steam Beech	EACH	£5.95
E37153	No.1.5 (Mag x7) Steam Beech	EACH	£5.95
E37154	No.2 (Mag x5) Steam Beech	EACH	£5.95
E37155	No.2.5 (Mag x4) Steam Beech	EACH	£5.95
E37156	No.3 (Mag x3.5) Steam Beech	EACH	£5.95
E37157	No.3.5 (Mag x3) Steam Beech	EACH	£5.95
E37158	No.4 (Mag x2.5) Steam Beech	EACH	£5.95
E37159	No.4.5 (Mag x2) Steam Beech	EACH	£5.95

## Horotec, Anodised Aluminium

Eyeglasses - Horotec Swiss - Anodised Aluminium

- Anodised aluminium body & rim
- Lens Ø22mm
- Screw Rim
- Very Robust
- Mineral glass lens
- "Mag" = Magnification
- Horotec 00.031.X



Code	Description	UOM	Price
E31464	No. 1 (Mag x10) Eyeglass	EACH	£43.75
E31465	No. 1.5 (Mag x6.7) Eyeglass	EACH	£43.75
E31466	No. 2 (Mag x5) Eyeglass	EACH	£43.75
E31467	No. 2.5 (Mag x4) Eyeglass	EACH	£43.75
E31468	No. 3 (Mag x3.5) Eyeglass	EACH	£43.75
E31469	No. 3.5 (Mag x3) Eyeglass	EACH	£43.75
E31470	No. 4 (Mag x2.5) Eyeglass	EACH	£43.75

## Horotec, Plastic with Anodised Aluminium Ring

Eyeglasses - Horotec Swiss - Plastic - Aluminium Ring

- Black plastic body with anodised aluminium screw ring
- Lens Ø22mm
- Screw Rim
- Very Robust
- Mineral glass lens
- "Mag" = Magnification



• Horotec 00.032.X

Code	Description	UOM	Price
E31471	No. 1 (Mag x10) Eyeglass	EACH	£22.95
E31472	No. 1.5 (Mag x6.7) Eyeglass	EACH	£22.95
E31473	No. 2 (Mag x5) Eyeglass	EACH	£22.95
E31474	No. 2.5 (Mag x4) Eyeglass	EACH	£22.95
E31475	No. 3 (Mag x3.5) Eyeglass	EACH	£22.95
E31476	No. 3.5 (Mag x3) Eyeglass	EACH	£22.95
E31477	No. 4 (Mag x2.5) Eyeglass	EACH	£22.95

## Horotec, Wood



Eyeglasses - Horotec Swiss - Wooden

- Horotec Swiss
- Box Wood
- Cherry Wood
- Pear Wood
- Platane Wood
- "Mag" = Magnification
- Mineral glass lens

All with Screw Bezel & Removable Ø22mm Lens

Code	Description	UOM	Price
E31526	Box Wood No. 1 (Mag x10)	EACH	£56.95
E31527	Box Wood No. 1.5 (Mag x6.7)	EACH	£56.95
E31528	Box Wood No. 2 (Mag x5.0)	EACH	£56.95
E31529	Box Wood No. 2.5 (Mag x4.0)	EACH	£56.95
E31530	Box Wood No. 3 (Mag x3.5)	EACH	£56.95
E31531	Box Wood No. 3.5 (Mag x3.0)	EACH	£56.95
E31532	Box Wood No. 4 (Mag x2.5)	EACH	£56.95
E31519	Cherry Wood No. 1 (Mag x10)	EACH	£43.95
E31520	Cherry Wood No. 1.5 (Mag x6.7)	EACH	£43.95
E31521	Cherry Wood No. 2 (Mag x5.0)	EACH	£43.95
E31522	Cherry Wood No. 2.5 (Mag x4.0)	EACH	£43.95
E31523	Cherry Wood No. 3 (Mag x3.5)	EACH	£43.95
E31524	Cherry Wood No. 3.5 (Mag x3.0)	EACH	£43.95
E31525	Cherry Wood No. 4 (Mag x2.5)	EACH	£43.95
E31512	Pear Wood No. 1 (Mag x10)	EACH	£48.95
E31513	Pear Wood No. 1.5 (Mag x6.7)	EACH	£48.95
E31514	Pear Wood No. 2 (Mag x5.0)	EACH	£48.95
E31515	Pear Wood No. 2.5 (Mag x4.0)	EACH	£48.95
E31516	Pear Wood No. 3 (Mag x3.5)	EACH	£48.95
E31517	Pear Wood No. 3.5 (Mag x3.0)	EACH	£48.95
E31518	Pear Wood No. 4 (Mag x2.5)	EACH	£48.95
E31533	Platane Wood No. 1 (Mag x10)	EACH	£48.95
E31534	Platane Wood No. 1.5 (Mag x6.7)	EACH	£48.95
E31535	Platane Wood No. 2 (Mag x5.0)	EACH	£48.95
E31536	Platane Wood No. 2.5 (Mag x4.0)	EACH	£48.95
E31537	Platane Wood No. 3 (Mag x3.5)	EACH	£48.95
E31538	Platane Wood No. 3.5 (Mag x3.0)	EACH	£48.95
E31539	Platane Wood No. 4 (Mag x2.5)	EACH	£48.95

## Diamond Gripping Tweezers

See Page 1041



## Diamond & Gemstone Weighing Scales

See Page 729



## LINEN MAGNIFIERS

### Linen Magnifiers



A hands free magnifier with a built in measuring scale and stand

For viewing and measuring small watch parts, jewels, stones, threads & even bar codes

- Excellent for viewing small parts
- Hands free
- Folds away for easy storage and transportation
- Sit in your workbench or counter top
- Great for customers to view rings, earrings & precious stones
- Sturdy metal frame
- x8 or x10
- Supplied in plastic pouch

Strength x Viewing Cut Out. See additional information for full specification.

Code	Description	UOM	Price
E39442	x8 Linen Magnifier (12 x 12mm)	EACH	£3.95
E39441	x10 Linen Magnifier (25 x 15mm)	EACH	£3.95

### Linen Magnifiers, Eschenbach



Eschenbach - Made in Germany

A hands free magnifier with a built in stand.

For viewing and measuring small watch parts, jewels, stones, threads & even bar codes.

- Stylish satin chrome finish
- Solid brass construction
- Fine quality, ground biconvex lens
- Excellent for viewing small parts
- Hands free
- Folds away for easy storage and transportation
- x5, x6, x8, x10 or x12
- Made in Germany

Strength x Viewing Cut Out. See additional information for full specification.

Code	Description	UOM	Price
L40269	x5 Linen Magnifier (30 x 30mm)	EACH	£35.50
L40270	x6 Linen Magnifier (25 x 25mm)	EACH	£30.60
L40271	x8 Linen Magnifier (20 x 20mm)	EACH	£23.50
L40272	x10 Linen Magnifier (15 x 15mm)	EACH	£27.15
L40273	x12 Linen Magnifier (10 x 10mm)	EACH	£28.50



**ORDER**  
tracking

### Linen Magnifiers, Plastic



A hands free magnifier with a built in measuring scale and stand

For viewing and measuring small watch parts, jewels, stones, threads & even bar codes

- Built in millimetre scale
- Excellent for viewing small parts
- Hands free
- Folds away for easy storage and transportation
- Plastic, lightweight frame
- x5, x7 or x10

Strength x Viewing Cut Out. See additional information for full specification.

Code	Description	UOM	Price
E39445	x5 Linen Magnifier (25 x 25mm)	EACH	£4.25
E39444	x7 Linen Magnifier (15 x 15mm)	EACH	£3.95
E39443	x10 Linen Magnifier (15 x 15mm)	EACH	£3.50

## LOUPE TRIPLETS & LOUPE CHAINS

Cousins presents a large selection of loupes, triplets and loupe chains.

Our range of robust pocket loupes is popular in a wide range of professions and hobbyists, including jewellery, precious metal hallmark viewing, coin inspection, gemmology, geology, printing, stamp collectors etc.

Triplet loupes are considered the very best of hand magnification technology compared to contemporary eye pieces because they are specifically manufactured with three lenses which are knitted together. Their combination eliminates most of the optical distortion from the outer edge of the lens, giving a colour corrected image.

Additionally available are loupes with achromatic and aplanatic lenses. These specially treated lenses are corrected for spherical aberrations and colour distortion, giving the user a perfect view of the object every time.

- Powerful precision glass lens brings fine micro-detail into view
- Made with the finest quality optics and with top quality metal cases
- All supplied with leather storage cases
- Available in brass or steel and in different size lenses
- See our PDF for a magnification vs focal length overview

Small loupes are easy to carry and very good to view fine items such as hallmarks. Larger loupes are excellent to view larger items giving a broader all round view.

How to use an Eye Loupe:

1. Bring the loupe up to your eye as close as is comfortable and definitely without touching your eyeball.
2. This is not a contact lense so keep the loupe

absolutely stationary and close to your eye, do not move the loupe.

3. There shouldn't be room for an object between your eye and the loupe. If there is, then get the loupe closer. Brushing against your eyelashes or your glasses is a good indicator that you've got it close enough.

4. Be sure to keep both eyes open. It is natural to want to close the other eye but eventually it leads to eye strain more quickly than keeping both eyes open.

### Harald Schneider Loupe



Harald Schneider Diamond Loupe - The Ultimate in Optical Performance

The ORIGINAL-SCHNEIDER-LOUPE© is an especially manufactured product with international reputation. For years it has been approved as the best loupe for diamond graduation worldwide. Since 1976, Harald Schneider have been manufacturing this product, with sales across the globe. Quite a large number of copies & fakes exist, but none come near to the very special high-end lens system. Many try, but none reach the high quality of the ORIGINAL-SCHNEIDER-LOUPE©.

- Schneider diamond loupe L2
- Achromatic & aplanatic
- Ø20mm lens
- x10 Magnification
- Improved lens system which provides total clarity and more depth
- Sharp, clear edge to edge distortion free viewing
- Harald Schneider branded loupe rope included
- Comes with protective leather carry case
- Often cited as "the best loupe in the world"

Code	Description	UOM	Price
E44195	x10 Harald Schneider Loupe	EACH	£295.00

**PRICE PROMISE**  
**GUARANTEE**



### Digital Weighing Scales



See Page 729

### Diamond Testers



See Page 669

### Bradbury's Hallmarking Guide



See Page 1379

**Zeiss Loupes**

Zeiss Loupes - High Performance Optics

- Zeiss loupes, known for their high performance, top quality optical product
- The diameter of the lens has been specifically chosen for the power of the magnification
- Aplanatic and achromatic lens
- Zero distortion, reflection, shadows or discolouration
- Anti reflective coating
- Reinforced, lightweight polymer frame
- Folding pocket loupes
- Multi lens available (E44194)
- Carl Zeiss vision
- Made in Germany

Dimensions:

- Magnification (lens diameter)
- See additional information for refractive power

**x6 (Ø22mm) Zeiss Loupe**



- Refractive power 24dpt
- Zeiss D24 AR

Code	Description	UOM	Price
E44193	x6 (Ø22mm) Zeiss Loupe	EACH	£59.95

**x6 + x3 (Ø22mm) Zeiss Loupe**



- Double lens
- Has both x6 or x3, combine to make x9
- Refractive power 36dpt (24 and 12 dpt each lens)
- Zeiss D36

Code	Description	UOM	Price
E44194	x6 + x3 (Ø22mm) Zeiss Loupe	EACH	£74.95

**x10 (Ø13mm) Zeiss Loupe**



- Refractive power 40dpt
- Zeiss D40

Code	Description	UOM	Price
E44192	x10 (Ø13mm) Zeiss Loupe	EACH	£67.95

**Regular Loupes, Hexagonal Head**

- 10x or 20x Magnification
- Head diameter: Ø20.5mm
- Chrome, chrome with rubber, gold or black finish
- Triplet style
- Folds away
- Supplied with leather carry case

Size: opened 50mm x 25mm x 22mm

Weight: 65g

**10x Black Loupe**

- Folding
- Ø20.5mm Hexagonal
- 10x Magnification
- Black
- Triplet Style



Code	Description	UOM	Price
E39447	10x Black Loupe	EACH	£5.95

**10x Chrome Loupe**

- Folding
- Ø20.5mm Hexagonal
- 10x Magnification
- Chrome
- Triplet Style



Code	Description	UOM	Price
E8672	10x Chrome Loupe	EACH	£8.50

**10x Chrome with Rubber Loupe**

- Folding
- Ø20.5mm Hexagonal
- 10x Magnification
- Chrome
- Triplet Style
- Textured rubber covering on triplet style circular lens to assist steady grip for inspection. Folds into hexagonal chrome metal case



Code	Description	UOM	Price
E9837	10x Chrome with Rubber Loupe	EACH	£7.50

**10x Gold Loupe**

- Folding
- Ø20.5mm Hexagonal
- 10x Magnification
- Gilt
- Triplet Style



Code	Description	UOM	Price
E8673	10x Gold Loupe	EACH	£8.50

**x20 Chrome Loupe**

- Folding
- Ø25mm hexagonal head
- 20x Magnification
- Chrome
- Triplet Style



Code	Description	UOM	Price
E39449	x20 Chrome Loupe	EACH	£8.75
Price breaks available, see website			

**Regular Loupes, Round Head**

- 10x magnification
- Head Diameter: Ø18mm
- Triplet style
- Chrome, chrome with rubber, gilt or black finish
- Folds away
- Supplied with leather carry case

Size: opened 50mm x 20mm x 20mm

Weight: 45g

**10x Black Loupe**

- Folding
- Ø18mm Round
- 10x Magnification
- Triplet Style
- Black



Code	Description	UOM	Price
E39448	10x Black Loupe	EACH	£4.65

**10x Chrome Loupe**

- Folding
- Ø18mm Round
- 10x Magnification
- Triplet Style
- Chrome



Code	Description	UOM	Price
E8674	10x Chrome Loupe	EACH	£3.95

**10x Chrome with Rubber Loupe**

- Folding
- Ø18mm Round
- 10x Magnification
- Textured rubber covering on triplet style circular lens to assist steady grip for inspection
- Folds into chrome colour metal case



Code	Description	UOM	Price
E31367	10x Chrome with Rubber Loupe	EACH	£5.50

**10x Gold Loupe**

- Folding
- Ø18mm Round
- 10x Magnification
- Triplet Style
- Gold colour



Code	Description	UOM	Price
E8675	10x Gold Loupe	EACH	£4.50

**10x Gold With Rubber Loupe**

- Folding
- Ø18mm Round
- 10x Magnification
- Textured rubber covering on triplet style circular lens to assist steady grip for inspection
- Folds into gold colour metal case



Code	Description	UOM	Price
E9836	10x Gold With Rubber Loupe	EACH	£6.50



**10x Plastic Loupe**

- Folding
- Ø16mm Round
- 10x Magnification
- Great value
- Folds into protective aluminium



Code	Description	UOM	Price
E39438	10x Plastic Loupe	EACH	£1.75
Price breaks available, see website			

**Regular Loupes with LED**

Ideal for use in any conditions these lighted loupes illuminate the field of view and stones like never before, a perfect light for viewing diamonds and other gemstones.

- Loupes with LED lights (2 or 6 LEDs)
- 10x magnification
- Ø21mm lens
- Triplet lenses
- Switch to turn the lights on and off
- Supplied with a leather storage case

LED loupes use an optical glass magnifier for a better viewing result. This incomparable tool is like a microscope, it can bring the smallest detail into view.

It eliminates one of the main problems one encounters when using a loupe - a lack of light! Proper illumination is as important as magnification for seeing close-in detail.

Dimensions:

- Opened: 85 x 28 x 25mm
- Weight: 65g
- Magnification (Lens diameter Ø)

**10x (Ø21mm) L.E.D. Loupe**

Loupe with LED Light

- 10 x Magnification
- Precisely examine lustre brilliance, sparkle and reflection.
- 21mm triplet lenses, oxidised surface, supplied with leather pouch.
- Requires 3 x RN371 batteries included in unit when purchased also sold separately



Size: full opened 90mm x 25mm x 25mm

Weight: 60g

Code	Description	UOM	Price
E20211	10x (Ø21mm) L.E.D. Loupe	EACH	£11.95

**10x (Ø21mm) L.E.D. (Circular) Loupe**

- Triplet Lens Ø20.5mm
- 10X True Daylight Magnification
- LED is placed as a "circular" tube around the lens
- Supplied with a leather pouch
- Precisely examine lustre brilliance, sparkle and reflection of gemstones.
- Requires 3 x RN394 batteries included in unit when purchased, also sold separately



Size: full opened 95mm x 28mm x 28mm

Weight: 60g

Code	Description	UOM	Price
E31871	10x (Ø21mm) L.E.D. (Circular) Loupe	EACH	£15.95

**Regular Loupes with LED, Achromatic/Aplanatic**

Ideal for use in any conditions these lighted loupes illuminate the field of view and stones like never before, a perfect light for viewing diamonds and other gemstones.

- Loupes with 6 LED lights
- 10x or 14x magnification
- Aplanatic - Corrected for spherical aberrations, for larger field of view from side to side
- Achromatic - Corrected for colour distortions, for true colour viewing
- Switch to turn the lights on and off
- Supplied with a leather storage case
- E44302 & E44301 with additional UV light which detects the fluorescent reaction of diamond
- UV light can be used to judge the colour grading & positioning of stones
- Made in Europe

LED loupes use an optical glass magnifier for a better viewing result. This incomparable tool is like a microscope, it can bring the smallest detail into view.

It eliminates one of the main problems one encounters when using a loupe - a lack of light! Proper illumination is as important as magnification for seeing close-in detail.

Dimensions:

- Magnification (Lens diameter Ø)

**10x (Ø18mm) Loupe with LED**



Code	Description	UOM	Price
E44300	10x (Ø18mm) Loupe with LED	EACH	£16.50

**10x (Ø18mm) Loupe with LED & UV**



Code	Description	UOM	Price
E44302	10x (Ø18mm) Loupe with LED & UV	EACH	£17.95



**Precious Metal Testing Kits**

See Page 716

**14x (Ø12mm) Loupe with LED & UV**



Code	Description	UOM	Price
E44301	14x (Ø12mm) Loupe with LED & UV	EACH	£19.50

**Specialist Loupes**

- Gowllands
- Multi magnification
- Triplet on tripod

**Gowllands Jewellers Loupe**

The original Gowllands Eye Loupe, a traditional and best seller used all over the world. (Leather case not included)

- Stainless Steel folds into case
- 10x Magnification
- Made in England



Code	Description	UOM	Price
E0548	Gowllands Jewellers Loupe	EACH	£7.95

**Multiply Magnification Triplet Loupe**

- Compact
- Portable 3 in 1 Loupe
- Triplet Lens
- Satin Finished
- Magnification 10x, 15x and 20x



Why carry three different loupes when you can have all three in one?

Size: opened 90mm x 90 mm x 20mm

Weight: 130g

Code	Description	UOM	Price
E20017	Multiply Magnification Triplet Loupe	EACH	£35.95

**Triplet Loupe on Tripod Stand**

- 21mm triplet lens tripod/stand with round legs
- Comes in leather pouch
- From India
- Belgium quality



Excellent table loupe for hands free and comfortable tool to use when examining gemstones, jewellery components, coins, stamps, etc.

- Move items to view with this loupe without lifting off your table, lowers risk of loss.
- The slide action lens can be moved up and down giving you variable focusing options.

Weight: 115g

Size: 50mm x 50mm x 40mm

Code	Description	UOM	Price
E20018	Triplet Loupe on Tripod Stand	EACH	£13.95

**Triplet Loupe**

- 10x magnification
- Head diameter: Ø18mm
- Triplet precision lens
- Aluminium, lightweight
- 9 sided head, excellent grip
- Folds away
- Supplied with leather carry case



Size: opened 50mm x 20mm x 20mm  
Weight: 30g

Code	Description	UOM	Price
E39450	Triplet Lens Loupe	EACH	£9.95

**Triplet Loupe, Achromatic/Aplanatic**



These innovative 10 and 20 times magnification, achromatic triplet jewellers' loupes are ideal inspection eyeglass for professional assessment of diamonds etc. plus inspecting gemstones, watches and many more applications.

- Metal construction, aluminium lens housing, finished in Black
- Top quality 10x18mm Glass Optic Lens
- Aplanatic - Corrected for spherical aberrations, for larger field of view from side to side
- Achromatic - Corrected for colour distortions, for true colour viewing
- Triplet Lens - Three separate lenses bonded together, vastly superior to doublets and single lens magnification
- Powerful precision glass lens brings fine micro-detail into view
- Made with the finest quality optics and with top quality metal cases
- Supplied with leather storage case
- Endorsed by the gemmological institute

Size: opened 50mm x 20mm x 18mm

Weight: 50g

Code	Description	UOM	Price
E9485	x10 Mag Triplet Achromatic / Aplanatic	EACH	£18.95
E9486	x20 Mag Triplet Achromatic / Aplanatic	EACH	£19.95

**Hearts & Arrows Loupe**

Hearts & Arrows Loupe with double round base for small and large stones. For checking the ideal cut of diamonds.



When viewed through this loupe an ideal cut stone will show a symmetrical pattern of hearts and the table side a pattern of arrows.

This instrument is a great sales aid for anyone who sells loose diamonds. By simply looking through this hearts and arrows loupe, your customers will be able to appreciate the perfectly cut diamond.

Info: This unit comes with two coloured filters, red and blue for different effects and one reversible holding plate.

Only if the stone has the desirable 'brilliant cut' can the "hearts and arrows" be seen, demonstrating to you and your customer the quality of the cut.

- Height 65mm
- Width 30mm
- Diameter of black holding disc 30mm
- Thickness 5.5mm
- Light weight plastic construction
- 2 filters, red and blue

Code	Description	UOM	Price
E39603	Hearts & Arrows Loupe	EACH	£4.95

**Jewellers, on Key Chain**

- 5x magnification
- Head diameter: Ø23mm
- Black
- Folds away
- Supplied on key chain
- Never be without it!
- Size when closed: 45 x 35 x 7mm



Code	Description	UOM	Price
E39439	Key Chain Loupe	EACH	£1.95

**Jewellers, Round Head, Multi Lens**

- Multi lens: x5, x10 & x15
- Black finish
- Made in India



Code	Description	UOM	Price
M36253	Ø21mm Multi Lens Loupe	EACH	£1.50

**Loupe Chains**



Loupe chains are available in different metals and chain styles to suit your lens.

- All of our loupe chains will fit any of our loupes and are well suited for sales staff.
- Reduce the chances of losing loupes in a busy workshop/retail environment.
- Always use a loupe to inspect pieces when buying precious metals or checking the quality of newly bought stock.

Attach the loupe to a loupe chain ensuring it is never lost.

- Key ring style coil fitted to attach a jeweller's loupe.
- Easy fit pear end clasp end
- wear round the neck in retail or buying environment (trade fairs, auctions, valuations)
- attach to the bench, counter or pocket ensuring it is always at hand
- Length of loupe chains are perfect to fit around the neck hence available when it is needed.

Sizes:

- Lengths: 38" to 40" (inches) Approx.

• Gold & Steel Colour

Code	Description	UOM	Price
C31916	Snake Chain, Gold Colour	EACH	£3.95
C31915	Snake Chain, Steel	EACH	£3.95
C31914	Rope (style) Chain Ø2.70mm	EACH	£3.95
C31913	Rope (style) Chain Ø3.30mm	EACH	£3.95

**Loupe Rope**

Attach your loupe to a loupe chain ensuring it is never lost

- Will fit any of our loupes and are well suited for sales staff
- Reduce the chances of losing loupes in a busy workshop/ retail environment
- Always use a loupe to inspect pieces when buying precious metals or checking the quality of newly bought stock
- Easy fit pear end clasp end
- Wear round the neck in retail or buying environment (trade fairs, auctions, valuations)
- Attach to the bench, counter or pocket ensuring it is always at hand
- Overall length 50cm



Code	Description	UOM	Price
E39451	Rope for Eye Loupes	EACH	£1.95

## Lamps & Lighting

See Page: 679

### Pearl and Stone Gauge

See Page 923

## MAGNIFIERS - HAND HELD & BENCH

### Bench & Table Top Magnifiers

Desk Magnifiers with stands

Desk magnifiers are an integral selling appliance for any busy retail jeweller. They are portable and lightweight making it easy to move around the counter between customers. Magnifying customers' jewellery prior to sale is an impressive selling technique, it instils both confidence into the purchase the customer is about to make. Often customers are unfamiliar with using eyeglasses or loupes; ergo these lenses allows customers to view purchases easily and clearly. Never worry about losing eyeglasses again!

- Also used by metal workers for inspection, sculptors, model makers, arts/crafts, coin collectors, stamp collectors, jewellers, silversmiths, embroiders, those in textiles and film rectification.
- 180° adjustable spectrum of rotation and release/locking tightening screw for complete flexibility.

### Bench & Table Top Magnifier



- Flexible hose, length 180mm
- Lens Ø89mm
- 2 x Magnification
- Cast iron stand with a plush hammerite finish
- Frame consists of brass with a chrome coating
- 360 x 80 x 80mm
- 850g

Code	Description	UOM	Price
M32983	Bench & Table Top Magnifier	EACH	£10.95

### 10x Magnifier, Ø22mm Lens

- Specifically for gemstones, rings, earrings etc
- Ø22mm lens
- 10x magnification
- Stainless steel base and neck
- 70 x 70 x 150mm (Base width x base length x overall height)
- 610g



Code	Description	UOM	Price
E39446	10x Magnifier, Ø22mm Lens	EACH	£12.95

### Bench & Table Top Magnifier with LED



- A4 bench top magnifier
- 4 LED's
- 4 spring loaded feet, can be folded away to use by hand or when storing
- Unbreakable acrylic lens
- Lightweight plastic body
- Comes with neck loop for ease of use and transportation

Specifications:

- Lens size 235 x 165mm
- 3x magnification
- 4 LED's
- 290 x 20 x 105mm (when standing)
- 290 x 200 x 15 when folded

Code	Description	UOM	Price
L44290	A4 Magnifier with LED	EACH	£7.50

### Hand Held Magnifiers

#### Ø32mm Bi-Aspheric Lens, Black



- High quality polycarbonate bi-aspheric lens.
- Compact 4 x magnifying lens
- Portable and ideally sized to carry in the pocket or wallet when buying or selling on the move.
- Its clever design encompasses a protective cover which separates from the centre enabling the cover to be used as a handle.

Size: full opened 110mm x 40mm x 4mm  
Lens: Diameter 30mm  
Weight: 16g

Code	Description	UOM	Price
M34127	Ø32mm Bi-Aspheric Lens, Black	EACH	£3.60

#### Ø32mm Bi-Aspheric Lens, Blue



- High quality polycarbonate bi-aspheric lens.
- Compact 4 x magnifying lens
- Portable and ideally sized to carry in the pocket or wallet when buying or selling on the move.
- Its clever design encompasses a protective cover which separates from the centre enabling the cover to be used as a handle.

Size: full opened 110mm x 40mm x 4mm  
Lens: Diameter 30mm  
Weight: 16g

Code	Description	UOM	Price
M34128	Ø32mm Bi-Aspheric Lens, Blue	EACH	£3.60

#### 45 x 45mm Rectangular Illuminated



Features:

- Magnification 3x
- Glass lens dimensions 45 x 45mm
- Secondary lens magnification (Ø20mm)
- 1 white high power spot LED
- Plastic body – comfortable grip
- Requires 3 x 1130 (included)
- Two step pull out, first step position without LED, second step pull out turns on the LED

Size: 200 x 85 x 20mm  
Weight: 140g

Code	Description	UOM	Price
M40256	45 x 45mm Rectangular Illuminated	EACH	£2.95

#### 50 x 50mm Rectangular Illuminated



- Rubber handle
- Ideal for close-up precision work with two way lighting system
- Perfect for jewellery or watch craft renovation etc.

Features:

- Magnification 4x
- Glass lens dimensions 2" x 2" (50mm x 50mm)
- 5 white LED bulbs and 1 high power spot LED
- Rubberised body – comfortable grip
- Requires 2 x AAA batteries (not included Cousins Ref: MN2400)

Size: 200 x 85 x 20mm  
Weight: 140g

Code	Description	UOM	Price
M35288	50 x 50mm Rectangular Illuminated	EACH	£7.95

www. Online Discounts

Display Turntables

See Page 658





**50 x 100mm Rectangular**

- Acrylic handle
- Robust
- 3 x magnification
- Aspheric lens size 100mm x 50mm
- Overall length: 155mm
- Weight: 170g



Code	Description	UOM	Price
M34129	50 x 100mm Rectangular	EACH	£6.95

**Ø50mm (2") Round Magnifier**

- Bakelite handle
- Ideal for jewellers, watch and clockmakers and hobbyists



Code	Description	UOM	Price
M20122	Ø50mm (2") Round Magnifier	EACH	£2.20

**Ø63mm (2.5") Round Magnifier**

- Bakelite handle
- Ideal for jewellers, watch and clockmakers and hobbyists



Code	Description	UOM	Price
M20123	Ø63mm (2.5") Round Magnifier	EACH	£2.85

**Ø65mm Round Illuminated**

- Blue in colour and comprising 7 x magnification, an excellent inspection tool with combined illumination.
- Twist handle to turn LED on and off
- Pocket size and light weight
- Takes 2 x AAA batteries included, replacement batteries are sold additionally (MN2400)



Size:  
 • Lens diameter Ø60mm  
 • Overall size 190 x 75 x 25mm  
 • Weight 120g

Code	Description	UOM	Price
M34126	Ø65mm Round Illuminated	EACH	£8.95

**Ø75mm (3") Round Magnifier**

- Bakelite handle
- Ideal for jewellers, watch and clockmakers and hobbyists



Code	Description	UOM	Price
M20124	Ø75mm (3") Round Magnifier	EACH	£3.65

**Hands Free Magnifiers with LED**



- This newly designed illumination magnifying glass comes with a spotlight.
- This newly-designed illuminated magnifying glass comes with a spotlight for use where you have poor lighting conditions.
  - Special two u shaped bracket stands incorporated on base body enabling hands free operation.
  - High grade lens can use for long periods of time observing without eye fatigue.
  - With leather carrying case that can be hanged on a belt
  - Inspect with precision gemstones jewellery/hall marks watches antiques minerals etc
  - Requires 2 AA Batteries code MN1500

Specification:

- Size: 110mm x 30mm x 110mm
- Magnification: x10 (Lens Ø28mm)
- Magnification: x15 (Lens Ø20mm)
- Weight: 100 grams

Code	Description	UOM	Price
E33836	10x Magnifier with Light	EACH	£10.95
E33837	15x Magnifier with Light	EACH	£10.95

**MICROSCOPE (POCKET)**

**Pocket Microscope**



- Eyeglasses - Pocket Microscope
- 40x Magnification pocket microscope with an aluminium silver anodised body.
- Main body consists of a black plastic eyepiece with an integrated pocket clip.
  - Clear acrylic focus stop for light penetration and 2mm x 0.02mm graduated measuring scale.
  - Perfect for inspecting gemstones.
  - One of the smallest pocket microscopes in the world.

Size: Overall length 120mm x 13mm  
 Weight: 20g

Code	Description	UOM	Price
M34130	Pocket Microscope 40 x Scale	EACH	£43.50

**FILES**



**Vallorbe Swiss Files:**

*Accuracy performance and long life are what a professional demands from a file. To be a real professional means to achieve precision within a fraction of a millimetre. At such a level precision you need an irreproachable tool a "deep hardened" file plus some more "production recipes" born from experience.*

*Since 1899 century of experience professionals around the world have selected this same brand. A brand of the Vallorbe group, a group which has been made the world leader by the professionals.*

*Precision engineering, watch making, makes of the finest jewelery, and the demanding industry and craft appreciate the efficiency the precision and long life of our tools.*

*Ready for efficient and long lasting use. The qualities of a tool preferred by the professional are also useful for the amateur. A high performance tool establishes and guarantees the reputation of the professional but also gives pleasure to the amateur.*



**Water Resistant Jewellery Tags**

**See Page 1198**



**Diamond & Gemstone Wrapping Papers**

**See Page 1187**



The file is often considered to be a commonplace tool, but it will last for a long time and deserves to be cared for by cleaning it from time to time therefore lengthening its life.

## ESCAPEMENT FILES

**vallorbe**  
swiss / **COUSINS**



Vallorbe - Swiss Made - Invest in the Best  
Escapement or watchmakers files are generally narrower and thinner than standard needle files and are used for the most delicate and precise filing requirements in watch and jewellery making. Escapement files have square handles and are always 140mm long from tip to handle end.

Available up to cut 10 (156 teeth/cm), with sharp edges and an extra slim point, our escapement files are perfectly suited to work requiring a low removal capacity. Perfect for gold, platinum, steel and titanium.

- Made from chrome steel, hardness 65HRc +/-2
- Certified ISO 9001 / EN29001

Cuts are expressed in numbers, they simply get finer as the number rises. Eg: 0=Coarse, 2=Medium, 4=Fine etc.

Dotted outer profiles on images indicate cutting faces.

### Set (3080, 3092) Vallorbe Swiss



Vallorbe 3092 - Swiss Made - Invest in the Best

Dimensions: Length x (Cut) x Section in mm

- 6 or 12 Escapement Files of varied and popular types
- Overall length 140mm
- Working length 55mm
- Made from chrome steel, hardness 65HRc +/-2
- Certified ISO 9001 / EN29001
- Cut = Higher the number, smoother (finer) the cut

Contains:

- Balance Wheel (3026)
- Barrette (3010)
- Barrette Parallel (3011)
- Crossing (3009)
- Equalling (3029)

- Half Round (3008)
- Knife (3004)
- Pillar (3017)
- Round (3021)
- Square (3020)
- Triangle (3014)
- Warding (3016)

Code	Description	UOM	Price
LE30924	Set (Cut 4) Vallorbe Swiss	PACK*12	£172.15
30926	Set (Cut 6) Vallorbe Swiss	PACK*12	£231.15
LE308010	Set (Cut 10) Vallorbe Swiss	PACK*6	£124.75

### Balance Wheel (3026) Vallorbe Swiss



Vallorbe 3026 - Swiss Made - Invest in the Best

Dimensions: Length x (Cut) x Section in mm

- Overall length 140mm
- Made from chrome steel, hardness 65HRc +/-2
- Certified ISO 9001 / EN29001
- Cut = Higher the number, smoother (finer) the cut

For additional sizes please use our Online Support - Products & Stock - New Item Request

Code	Description	UOM	Price
3026354	35mm (Cut 4) 2.9 x 1.2mm	EACH	£13.95
3026356	35mm (Cut 6) 2.9 x 1.2mm	EACH	£14.25
30263510	35mm (Cut 10) 2.9 x 1.2mm	EACH	£24.25

### Barrette (3007) Vallorbe Swiss



Vallorbe 3007 - Swiss Made - Invest in the Best

Dimensions: Length x (Cut) x Section in mm

- Overall length 140mm
- 3 cutting sides
- Made from chrome steel, hardness 65HRc +/-2
- Certified ISO 9001 / EN29001
- Cut = Higher the number, smoother (finer) the cut

For additional sizes please use our Online Support - Products & Stock - New Item Request

Code	Description	UOM	Price
3007552	55mm (Cut 2) 4.5 x 1.3mm	EACH	£19.65
3007554	55mm (Cut 4) 4.5 x 1.3mm	EACH	£22.25

### Barrette (3010) Vallorbe Swiss, Safety Back



Vallorbe 3010 - Swiss Made - Invest in the Best

Dimensions: Length x (Cut) x Section in mm

- Overall length 140mm
- 1 Side Cutting
- Made from chrome steel, hardness 65HRc +/-2
- Certified ISO 9001 / EN29001
- Cut = Higher the number, smoother (finer) the cut

For additional sizes please use our Online Support - Products & Stock - New Item Request

Code	Description	UOM	Price
3010400	40mm (Cut 0) 3.7 x 1.3mm	EACH	£12.95
3010402	40mm (Cut 2) 3.7 x 1.3mm	EACH	£11.75
3010403	40mm (Cut 3) 3.7 x 1.3mm	EACH	£11.95
3010404	40mm (Cut 4) 3.7 x 1.3mm	EACH	£11.95
3010406	40mm (Cut 6) 3.7 x 1.3mm	EACH	£13.10
3010408	40mm (Cut 8) 3.7 x 1.3mm	EACH	£15.15
3010550	55mm (Cut 0) 4.5 x 1.3mm	EACH	£11.95
3010552	55mm (Cut 2) 4.5 x 1.3mm	EACH	£11.85
3010554	55mm (Cut 4) 4.5 x 1.3mm	EACH	£12.00

3010556	55mm (Cut 6) 4.5 x 1.3mm	EACH	£12.10
3010558	55mm (Cut 8) 4.5 x 1.3mm	EACH	£13.80
30105510	55mm (Cut 10) 4.5 x 1.3mm	EACH	£21.10

### Barrette (3011) Vallorbe Swiss, Parallel



Vallorbe 3011 - Swiss Made - Invest in the Best

Dimensions: Length x (Cut) x Section in mm

- Overall length 140mm
- 1 Side Cutting
- Made from chrome steel, hardness 65HRc +/-2
- Certified ISO 9001 / EN29001
- Cut = Higher the number, smoother (finer) the cut

For additional sizes please use our Online Support - Products & Stock - New Item Request

Code	Description	UOM	Price
3011482	48mm (Cut 2) 4.1 x 1.2mm	EACH	£11.95
3011484	48mm (Cut 4) 4.1 x 1.2mm	EACH	£12.45
3011486	48mm (Cut 6) 4.1 x 1.2mm	EACH	£14.25

### Crossing (3009) Vallorbe Swiss



Vallorbe 3009 - Swiss Made - Invest in the Best

Dimensions: Length x (Cut) x Section in mm

- Overall length 140mm
- Made from chrome steel, hardness 65HRc +/-2
- Certified ISO 9001 / EN29001
- Cut = Higher the number, smoother (finer) the cut

For additional sizes please use our Online Support - Products & Stock - New Item Request

Code	Description	UOM	Price
3009402	40mm (Cut 2) 3.7 x 1.4mm	EACH	£15.70
3009404	40mm (Cut 4) 3.7 x 1.4mm	EACH	£14.40
3009406	40mm (Cut 6) 3.7 x 1.4mm	EACH	£16.75
3009408	40mm (Cut 8) 3.7 x 1.4mm	EACH	£17.70
3009552	55mm (Cut 2) 4.8 x 1.6mm	EACH	£15.70
3009554	55mm (Cut 4) 4.8 x 1.6mm	EACH	£12.95
3009556	55mm (Cut 6) 4.8 x 1.6mm	EACH	£13.95
3009558	55mm (Cut 8) 4.8 x 1.6mm	EACH	£16.95
30095510	55mm (Cut 10) 4.8 x 1.6mm	EACH	£20.95

### Dovetail (3001) Vallorbe Swiss



Vallorbe 3001 - Swiss Made - Invest in the Best

Dimensions: Length x (Cut) x Section in mm

- Overall length 140mm
- Made from chrome steel, hardness 65HRc +/-2
- Certified ISO 9001 / EN29001
- Cut = Higher the number, smoother (finer) the cut

For additional sizes please use our Online Support - Products & Stock - New Item Request

Code	Description	UOM	Price
3001354	35mm (Cut 4) 3.0 x 1.0mm	EACH	£12.50
3001356	35mm (Cut 6) 3.0 x 1.0mm	EACH	£12.95

The UK's Largest  
File Selection

### Equalling (3029) Vallorbe Swiss



Vallorbe 3029 - Swiss Made - Invest in the Best

Dimensions: Length x (Cut) x Section in mm

- Overall length 140mm
- Made from chrome steel, hardness 65HRC +/-2
- Certified ISO 9001 / EN29001
- Cut = Higher the number, smoother (finer) the cut

For additional sizes please use our Online Support - Products & Stock - New Item Request

Code	Description	UOM	Price
3029552	55mm (Cut 2) 4.7 x 0.7mm	EACH	£11.75
3029554	55mm (Cut 4) 4.7 x 0.7mm	EACH	£11.95
3029556	55mm (Cut 6) 4.7 x 0.7mm	EACH	£13.95

### Half Round (3008) Vallorbe Swiss



Vallorbe 3008 - Swiss Made - Invest in the Best

Dimensions: Length x (Cut) x Section in mm

- Overall length 140mm
- Made from chrome steel, hardness 65HRC +/-2
- Certified ISO 9001 / EN29001
- Cut = Higher the number, smoother (finer) the cut

For additional sizes please use our Online Support - Products & Stock - New Item Request

Code	Description	UOM	Price
3008402	40mm (Cut 2) 3.8 x 1.4mm	EACH	£13.85
3008404	40mm (Cut 4) 3.8 x 1.4mm	EACH	£13.95
3008406	40mm (Cut 6) 3.8 x 1.4mm	EACH	£17.85
3008408	40mm (Cut 8) 3.8 x 1.4mm	EACH	£18.95
3008552	55mm (Cut 2) 4.6 x 1.6mm	EACH	£13.95
3008554	55mm (Cut 4) 4.6 x 1.6mm	EACH	£13.95
3008556	55mm (Cut 6) 4.6 x 1.6mm	EACH	£16.15
3008558	55mm (Cut 8) 4.6 x 1.6mm	EACH	£22.65
30085510	55mm (Cut 10) 4.6 x 1.6mm	EACH	£28.95

### Knife Edge (3004) Vallorbe Swiss



Vallorbe 3004 - Swiss Made - Invest in the Best

Dimensions: Length x (Cut) x Section in mm

- Overall length 140mm
- All sides cutting
- Made from chrome steel, hardness 65HRC +/-2
- Certified ISO 9001 / EN29001
- Cut = Higher the number, smoother (finer) the cut

For additional sizes please use our Online Support - Products & Stock - New Item Request

Code	Description	UOM	Price
3004552	55mm (Cut 2) 5.0 x 1.3mm	EACH	£11.35
3004554	55mm (Cut 4) 5.0 x 1.3mm	EACH	£12.15
3004556	55mm (Cut 6) 5.0 x 1.3mm	EACH	£13.95
3004558	55mm (Cut 8) 5.0 x 1.3mm	EACH	£19.95

### Pillar (3017) Vallorbe Swiss



Vallorbe 3017 - Swiss Made - Invest in the Best

Dimensions: Length x (Cut) x Section in mm

- Overall length 140mm
- Made from chrome steel, hardness 65HRC +/-2

- Certified ISO 9001 / EN29001
- Cut = Higher the number, smoother (finer) the cut

For additional sizes please use our Online Support - Products & Stock - New Item Request

Code	Description	UOM	Price
3017552	55mm (Cut 2) 5.0 x 0.9mm	EACH	£9.95
3017554	55mm (Cut 4) 5.0 x 0.9mm	EACH	£11.95
3017556	55mm (Cut 6) 5.0 x 0.9mm	EACH	£11.95
3017558	55mm (Cut 8) 5.0 x 0.9mm	EACH	£11.95
30175510	55mm (Cut 10) 5.0 x 0.9mm	EACH	£21.75
3017652	65mm (Cut 2) 5.0 x 1.3mm	EACH	£12.50
3017654	65mm (Cut 4) 5.0 x 1.3mm	EACH	£13.85
3017656	65mm (Cut 6) 5.0 x 1.3mm	EACH	£15.65
3017658	65mm (Cut 8) 5.0 x 1.3mm	EACH	£16.75

### Round (3021) Vallorbe Swiss



Vallorbe 3021 - Swiss Made - Invest in the Best

Dimensions: Length x (Cut) x Section in mm

- Overall length 140mm
- Round or Tapered (Rat Tail)
- Made from chrome steel, hardness 65HRC +/-2
- Certified ISO 9001 / EN29001
- Cut = Higher the number, smoother (finer) the cut

For additional sizes please use our Online Support - Products & Stock - New Item Request

Code	Description	UOM	Price
3021550	55mm (Cut 0) Maximum Ø1.50mm	EACH	£9.00
3021552	55mm (Cut 2) Maximum Ø1.50mm	EACH	£8.45
3021554	55mm (Cut 4) Maximum Ø1.50mm	EACH	£8.85
3021556	55mm (Cut 6) Maximum Ø1.50mm	EACH	£9.55
3021558	55mm (Cut 8) Maximum Ø1.50mm	EACH	£12.35
30215510	55mm (Cut 10) Maximum Ø1.5mm	EACH	£16.85
3021650	65mm (Cut 0) Maximum Ø2.0mm	EACH	£9.30
3021652	65mm (Cut 2) Maximum Ø2.0mm	EACH	£8.45
3021653	65mm (Cut 3) Maximum Ø2.0mm	EACH	£10.10
3021656	65mm (Cut 6) Maximum Ø2.0mm	EACH	£10.25
3021658	65mm (Cut 8) Maximum Ø2.0mm	EACH	£10.95

### Rounding Off (3012) Vallorbe Swiss



Vallorbe 3012 - Swiss Made - Invest in the Best

Dimensions: Length x (Cut) x Section in mm

- Overall length 140mm
- All sides cutting
- Made from chrome steel, hardness 65HRC +/-2
- Certified ISO 9001 / EN29001
- Cut = Higher the number, smoother (finer) the cut

For additional sizes please use our Online Support - Products & Stock - New Item Request

Code	Description	UOM	Price
3012402	40mm (Cut 2) 3.6 x 0.8mm	EACH	£14.10
3012404	40mm (Cut 4) 3.6 x 0.8mm	EACH	£14.70
3012406	40mm (Cut 6) 3.6 x 0.8mm	EACH	£14.60

### Square (3020) Vallorbe Swiss



Vallorbe 3020 - Swiss Made - Invest in the Best

Dimensions: Length x (Cut) x Section in mm

- Overall length 140mm
- All sides cutting

- Made from chrome steel, hardness 65HRC +/-2
- Certified ISO 9001 / EN29001
- Cut = Higher the number, smoother (finer) the cut

For additional sizes please use our Online Support - Products & Stock - New Item Request

Code	Description	UOM	Price
3020550	55mm (Cut 0) Maximum 1.7mm	EACH	£13.65
3020552	55mm (Cut 2) Maximum 1.7mm	EACH	£10.75
3020553	55mm (Cut 3) Maximum 1.7mm	EACH	£11.75
3020554	55mm (Cut 4) Maximum 1.7mm	EACH	£13.50
3020555	55mm (Cut 5) Maximum 1.7mm	EACH	£14.50
3020556	55mm (Cut 6) Maximum 1.7mm	EACH	£11.15
3020558	55mm (Cut 8) Maximum 1.7mm	EACH	£15.50
30205510	55mm (Cut 10) Maximum 1.7mm	EACH	£27.90
3020650	65mm (Cut 0) Maximum 1.9mm	EACH	£13.75
3020652	65mm (Cut 2) Maximum 1.9mm	EACH	£11.15
3020654	65mm (Cut 4) Maximum 1.9mm	EACH	£13.65
3020656	65mm (Cut 6) Maximum 1.9mm	EACH	£15.50
3020658	65mm (Cut 8) Maximum 1.9mm	EACH	£15.95

### Triangular (3014) Vallorbe Swiss



Vallorbe 3014 - Swiss Made - Invest in the Best

Dimensions: Length x (Cut) x Section in mm

- Overall length 140mm
- All sides cutting
- Made from chrome steel, hardness 65HRC +/-2
- Certified ISO 9001 / EN29001
- Cut = Higher the number, smoother (finer) the cut

For additional sizes please use our Online Support - Products & Stock - New Item Request

Code	Description	UOM	Price
3014402	40mm (Cut 2) Maximum 2.8mm	EACH	£11.55
3014404	40mm (Cut 4) Maximum 2.8mm	EACH	£11.40
3014406	40mm (Cut 6) Maximum 2.8mm	EACH	£12.70
3014550	55mm (Cut 0) Maximum 3.4mm	EACH	£12.10
3014552	55mm (Cut 2) Maximum 3.4mm	EACH	£10.40
3014554	55mm (Cut 4) Maximum 3.4mm	EACH	£11.40
3014556	55mm (Cut 6) Maximum 3.4mm	EACH	£15.55
3014558	55mm (Cut 8) Maximum 3.4mm	EACH	£15.95
30145510	55mm (Cut 10) Maximum 3.4mm	EACH	£25.90

### Warding (3016) Vallorbe Swiss



Vallorbe 3016 - Swiss Made - Invest in the Best

Dimensions: Length x (Cut) x Section in mm

- Overall length 140mm
- All sides cutting
- Made from chrome steel, hardness 65HRC +/-2
- Certified ISO 9001 / EN29001
- Cut = Higher the number, smoother (finer) the cut

For additional sizes please use our Online Support - Products & Stock - New Item Request

Code	Description	UOM	Price
3016552	55mm (Cut 2) 4.6 x 0.9mm	EACH	£15.25
3016554	55mm (Cut 4) 4.6 x 0.9mm	EACH	£14.35
3016556	55mm (Cut 6) 4.6 x 0.9mm	EACH	£16.70

### Watch Anchor (3015) Vallorbe Swiss



Vallorbe 3015 - Swiss Made - Invest in the Best

Dimensions: Length x (Cut) x Section in mm

- Overall length 140mm
- All sides cutting
- Made from chrome steel, hardness 65HRc +/-2
- Certified ISO 9001 / EN29001
- Cut = Higher the number, smoother (finer) the cut

For additional sizes please use our Online Support - Products & Stock - New Item Request

Code	Description	UOM	Price
3015556	55mm (Cut 6) 4.4 x 0.8mm	EACH	£25.85
3015558	55mm (Cut 8) 4.4 x 0.8mm	EACH	£27.75

## HAND FILES "WITH TANG" & SPECIALIST



Vallorbe - Swiss Made - Invest in the Best

- with Tang
- Made from chrome steel, hardness 65HRc +/-2
- Certified ISO 9001 / EN29001

All our files in the following sections and types are of superlative Swiss Vallorbe manufacturer. The quality is unrivalled and the range vast. Selection is only a matter of deciding on type, length-size and cut.

Cuts are expressed in numbers, they simply get finer as the number rises. Eg: 0=Coarse, 2=Medium, 5=Fine etc.

Dotted outer profiles on images indicate cutting faces.

Lengths (excludes Tang):

- 4" = 100mm
- 5" = 125mm
- 6" = 150mm
- 7" = 175mm
- 8" = 200mm
- 10" = 250mm
- 12" = 300mm

For additional sizes please use our Online Support - Products & Stock - New Item Request

## The UK's Largest File Selection

Brush for Cleaning Files

See Page 799



Graver Tools

See Page 904



### Barrette (1060\*) Cousins Euro, Safety Back



Cousins Files - EU Made - Invest in the Best

Dimensions: Length (excludes Tang) x (Cut) x Section in mm

Barrette files are tapered in width and thickness, coming to a rounded point at the end. Only the flat side is cut, and the other sides are all safe. For doing flat work.

- Swiss Style\*
- Excellent Value

For additional sizes please use our Online Support - Products & Stock - New Item Request

Code	Description	UOM	Price
F35278	150mm (Cut 0) 15.00 x 3.40mm	EACH	£8.05
F35279	150mm (Cut 2) 15.00 x 3.40mm	EACH	£9.35
F35280	150mm (Cut 4) 15.00 x 3.40mm	EACH	£10.65

### Barrette (1060) Vallorbe, Safety Back



Vallorbe 1060 - Swiss Made - Invest in the Best

Dimensions: Length (excludes Tang) x (Cut) x Section in mm

Barrette files are tapered in width and thickness, coming to a rounded point at the end. Only the flat side is cut, and the other sides are all safe. For doing flat work.

- Made from chrome steel, hardness 65HRc +/-2
- Certified ISO 9001 / EN29001
- Cut = Higher the number, smoother (finer) the cut

For additional sizes please use our Online Support - Products & Stock - New Item Request

Code	Description	UOM	Price
106042	100mm (Cut 2) 12.4 x 2.6mm	EACH	£15.25
106044	100mm (Cut 4) 12.4 x 2.6mm	EACH	£16.80
106060	150mm (Cut 0) 15.5 x 3.5mm	EACH	£17.30
106062	150mm (Cut 2) 15.5 x 3.5mm	EACH	£17.25
106064	150mm (Cut 4) 15.5 x 3.5mm	EACH	£19.30

### Crochet (1230) Vallorbe Swiss



Vallorbe 1230 - Swiss Made - Invest in the Best

Dimensions: Length (excludes Tang) x (Cut) x Section in mm

Crochet files are tapered in width and gradually tapered in thickness, with two flats and radiused edges, cut all around. Used in filing junctions between flat and curved surface, and slots with rounded edges.

- Made from chrome steel, hardness 65HRc +/-2
- Certified ISO 9001 / EN29001
- Cut = Higher the number, smoother (finer) the cut

For additional sizes please use our Online Support - Products & Stock - New Item Request

Code	Description	UOM	Price
1230042	100mm (Cut 2) 7.5 x 2.2mm	EACH	£22.50
1230062	150mm (Cut 2) 10.0 x 3.3mm	EACH	£26.50

### Crossing (1960) Vallorbe Swiss



Vallorbe 1960 - Swiss Made - Invest in the Best

Dimensions: Length (excludes Tang) x (Cut) x Section in mm

Crossing files are half round on two sides with one side having a larger radius than the other. Tapered in width and thickness. For filing interior curved surfaces. The double radius makes possible filing at the junction of two curved surfaces or a straight and curved surface.

- Made from chrome steel, hardness 65HRc +/-2
- Certified ISO 9001 / EN29001
- Cut = Higher the number, smoother (finer) the cut

For additional sizes please use our Online Support - Products & Stock - New Item Request

Code	Description	UOM	Price
19600352	90mm (Cut 2) 10.2 x 2.9mm	EACH	£33.95
1960354	90mm (Cut 4) 10.2 x 2.9mm	EACH	£32.95
1960356	90mm (Cut 4) 10.2 x 2.9mm	EACH	£32.95
196042	100mm (Cut 2) 11.9 x 3.6mm	EACH	£28.05
1960060	150mm (Cut 0) 14.8 x 5.0mm	EACH	£35.60
196062	150mm (Cut 2) 14.8 x 5.0mm	EACH	£36.50
196064	150mm (Cut 4) 14.8 x 5.0mm	EACH	£44.95
1960066	150mm (Cut 6) 14.8 x 5.0mm	EACH	£59.95

### Equalling (1180) Vallorbe Swiss



Vallorbe 1180 - Swiss Made - Invest in the Best

Dimensions: Length (excludes Tang) x (Cut) x Section in mm

Equalling files are parallel in width and thinner in thickness. Used for filing slots and corners.

- Made from chrome steel, hardness 65HRC +/-2
- Certified ISO 9001 / EN29001
- Cut = Higher the number, smoother (finer) the cut

For additional sizes please use our Online Support - Products & Stock - New Item Request

Code	Description	UOM	Price
118004213	100mm (Cut 2) 10.0 x 1.3mm	EACH	£19.25
11800422	100mm (Cut 2) 10.0 x 2.0mm	EACH	£17.55
11800442	100mm (Cut 4) 10.0 x 2.0mm	EACH	£20.35
11800622	150mm (Cut 2) 13.0 x 2.0mm	EACH	£20.75
118006228	150mm (Cut 2) 13.0 x 2.8mm	EACH	£20.75
11800642	150mm (Cut 4) 13.0 x 2.0mm	EACH	£23.95

### Equalling (1185) Vallorbe Swiss, Special Thickness

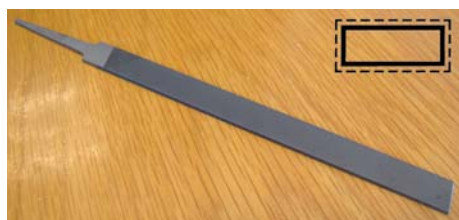

Vallorbe 1185 - Swiss Made - Invest in the Best

Dimensions: Length (excludes Tang) x (Cut) x Section in mm\*

\*+0/-0.08mm

Equalling files are parallel in width and thinner in thickness. Used for filing slots and corners.

- Made from chrome steel, hardness 65HRC +/-2
- Certified ISO 9001 / EN29001
- Cut = Higher the number, smoother (finer) the cut

For additional sizes please use our Online Support - Products & Stock - New Item Request

Code	Description	UOM	Price
118504420	100mm (Cut 4) 10.0 x 0.91mm	EACH	£23.70
118506214	150mm (Cut 2) 13.0 x 2.03mm	EACH	£27.35

### Half Round (1560\*) Cousins Euro, Regular



Cousins Files - EU Made - Invest in the Best

Dimensions: Length (excludes Tang) x (Cut) x Section in mm

Half round ring files taper in width and thickness, coming to a point. Used for filing inside of rings.

- Swiss Style\*
- Excellent Value

For additional sizes please use our Online Support - Products & Stock - New Item Request

Code	Description	UOM	Price
F35272	150mm (Cut 0) 15.00 x 4.50mm	EACH	£9.75
F35273	150mm (Cut 2) 15.00 x 4.50mm	EACH	£10.95
F35274	150mm (Cut 4) 15.00 x 4.50mm	EACH	£12.55

### Half Round (1560) Vallorbe Swiss, Regular



Vallorbe 1560 - Swiss Made - Invest in the Best

Dimensions: Length (excludes Tang) x (Cut) x Section in mm

Half round ring files taper in width and thickness, coming to a point. Used for filing inside of rings.

- Made from chrome steel, hardness 65HRC +/-2
- Certified ISO 9001 / EN29001
- Cut = Higher the number, smoother (finer) the cut

For additional sizes please use our Online Support - Products & Stock - New Item Request

Code	Description	UOM	Price
156030	75mm (Cut 0) 8.10 x 2.60mm	EACH	£19.95
156040	100mm (Cut 0) 12.50 x 3.60mm	EACH	£18.25
156042	100mm (Cut 2) 12.50 x 3.60mm	EACH	£20.25
156043	100mm (Cut 3) 12.50 x 3.60mm	EACH	£24.35
156044	100mm (Cut 4) 12.50 x 3.60mm	EACH	£24.95
156045	100mm (Cut 5) 12.50 x 3.60mm	EACH	£31.75
156052	125mm (Cut 2) 13.10 x 4.10mm	EACH	£22.60
1560600	150mm (Cut 00) 15.30 x 4.70mm	EACH	£21.25
156060	150mm (Cut 0) 15.30 x 4.70mm	EACH	£20.15
156062	150mm (Cut 2) 15.30 x 4.70mm	EACH	£23.50
156063	150mm (Cut 3) 15.30 x 4.70mm	EACH	£29.50
156064	150mm (Cut 4) 15.30 x 4.70mm	EACH	£29.95
156066	150mm (Cut 6) 15.30 x 4.70mm	EACH	£45.95
156076	170mm (Cut 6) 17.00 x 5.70mm	EACH	£45.95
1560800	200mm (Cut 00) 21.10 x 6.30mm	EACH	£29.25
156080	200mm (Cut 0) 21.10 x 6.30mm	EACH	£30.95
156081	200mm (Cut 1) 21.10 x 6.30mm	EACH	£36.95
156082	200mm (Cut 2) 21.10 x 6.30mm	EACH	£38.95

### Half Round (1566\*) Cousins Euro, Slim



Cousins Files - EU Made - Invest in the Best

Dimensions: Length (excludes Tang) x (Cut) x Section in mm

Half round ring files taper in width and thickness, coming to a point, and are narrower than a regular half round. Used for filing inside of rings.

- Swiss Style\*
- Excellent Value

For additional sizes please use our Online Support - Products & Stock - New Item Request

Code	Description	UOM	Price
F35275	150mm (Cut 0) 13.00 x 4.40mm	EACH	£11.75
F35276	150mm (Cut 2) 13.00 x 4.40mm	EACH	£12.25
F35277	150mm (Cut 4) 13.00 x 4.40mm	EACH	£15.60

### Half Round (1566) Vallorbe Swiss, Slim



Vallorbe 1566 - Swiss Made - Invest in the Best

Dimensions: Length (excludes Tang) x (Cut) x Section in mm

Half round ring files taper in width and thickness, coming to a point, and are narrower than a regular half round. Used for filing inside of rings.

- A slim file for rings etc.
- Made from chrome steel, hardness 65HRC +/-2
- Certified ISO 9001 / EN29001
- Cut = Higher the number, smoother (finer) the cut

For additional sizes please use our Online Support - Products & Stock - New Item Request

Code	Description	UOM	Price
1566600	150mm (Cut 00) 12.70 x 3.50mm	EACH	£26.65
156660	150mm (Cut 0) 12.70 x 3.50mm	EACH	£27.10
156661	150mm (Cut 1) 12.70 x 3.50mm	EACH	£29.85
156662	150mm (Cut 2) 12.70 x 3.50mm	EACH	£29.25
156663	150mm (Cut 3) 12.70 x 3.50mm	EACH	£34.05
156664	150mm (Cut 4) 12.70 x 3.50mm	EACH	£34.95
156666	150mm (Cut 6) 12.70 x 3.50mm	EACH	£64.55
156681	200mm (Cut 1) 15.30 x 4.70mm	EACH	£39.55

### Half Round (1567) Vallorbe Swiss, Extra Slim



Vallorbe 1567 - Swiss Made - Invest in the Best

Dimensions: Length (excludes Tang) x (Cut) x Section in mm

Half round ring files taper in width and thickness, coming to a point, and are narrower than a regular half round. Used for filing inside of rings.

- A very narrow file ideal for small rings etc.
- Made from chrome steel, hardness 65HRC +/-2
- Certified ISO 9001 / EN29001
- Cut = Higher the number, smoother (finer) the cut

For additional sizes please use our Online Support - Products & Stock - New Item Request

Code	Description	UOM	Price
156760	150mm (Cut 0) 9.80 x 2.80mm	EACH	£34.15
156762	150mm (Cut 2) 9.80 x 2.80mm	EACH	£37.70
156764	150mm (Cut 4) 9.80 x 2.80mm	EACH	£43.90

The UK's Largest File Selection

## Joint (1170) Vallorbe Swiss, Round Edges



Vallorbe 1170 - Swiss Made - Invest in the Best

Dimensions: Length (excludes Tang) x (Cut) x Section in mm (file thickness)

Joint round edge files are parallel in width and thickness, with rounded edges. The flats are safe (no teeth) and cut on the rounded edges only. Used for making joints and hinges.

- A very narrow file ideal for small rings etc.
- Made from chrome steel, hardness 65HRC +/-2
- Certified ISO 9001 / EN29001
- Cut = Higher the number, smoother (finer) the cut

For additional sizes please use our Online Support - Products & Stock - New Item Request

Code	Description	UOM	Price
11704204	100mm (Cut 4) 0.42mm Thick	EACH	£18.45
11704206	100mm (Cut 6) 0.60mm Thick	EACH	£18.65

## Knife Edge (1760) Vallorbe Swiss

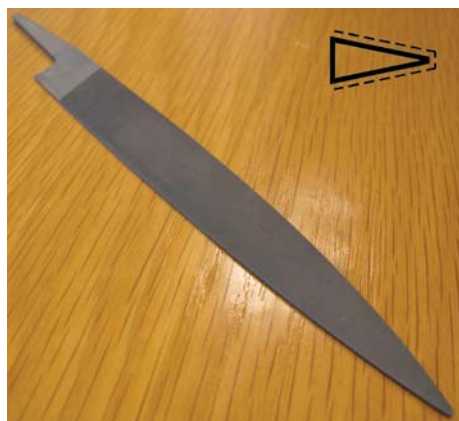

Vallorbe 1760 - Swiss Made - Invest in the Best

Dimensions: Length (excludes Tang) x (Cut) x Section in mm

Knife files are tapered in width and thickness, but the knife edge has the same thickness the whole length, with the knife edge having an arc to it. Used for slotting or wedging operations.

- Made from chrome steel, hardness 65HRC +/-2
- Certified ISO 9001 / EN29001
- Cut = Higher the number, smoother (finer) the cut

For additional sizes please use our Online Support - Products & Stock - New Item Request

Code	Description	UOM	Price
176042	100mm (Cut 2) 12.40 x 2.80mm	EACH	£18.65
176044	100mm (Cut 4) 12.40 x 2.80mm	EACH	£20.15
176060	150mm (Cut 0) 17.90 x 3.50mm	EACH	£20.95
176061	150mm (Cut 1) 17.90 x 3.50mm	EACH	£21.10
176062	150mm (Cut 2) 17.90 x 3.50mm	EACH	£21.90
176064	150mm (Cut 4) 17.90 x 3.50mm	EACH	£25.80
176080	200mm (Cut 0) 22.00 x 4.20mm	EACH	£29.95
176082	200mm (Cut 2) 22.00 x 4.20mm	EACH	£30.95

### Jewellery Drill Bits

See Page 837



## Oval (1990) Vallorbe Swiss, Die Sinker



Vallorbe 1990 - Swiss Made - Invest in the Best

Dimensions: Length (excludes Tang) x (Cut) x Section in mm

- Made from chrome steel, hardness 65HRC +/-2
- Certified ISO 9001 / EN29001
- Cut = Higher the number, smoother (finer) the cut

For additional sizes please use our Online Support - Products & Stock - New Item Request

Code	Description	UOM	Price
199060	150mm (Cut 0) 8.6 x 4.4mm	EACH	£49.95

## Pillar (1132) Vallorbe Swiss, Regular

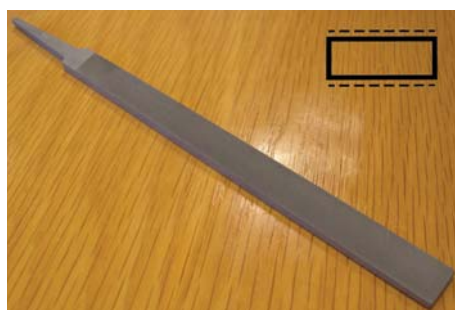

Vallorbe 1132 - Swiss Made - Invest in the Best

Dimensions: Length (excludes Tang) x (Cut) x Section in mm

Pillar files are parallel in width and tapered in thickness for perfectly flat filing for precision work.

- Regular pillar (narrower than standard pillar) style with two blind edges
- Made from chrome steel, hardness 65HRC +/-2
- Certified ISO 9001 / EN29001
- Cut = Higher the number, smoother (finer) the cut

For additional sizes please use our Online Support - Products & Stock - New Item Request

Code	Description	UOM	Price
113240	100mm (Cut 0) 9.50 x 2.50mm	EACH	£12.15
113242	100mm (Cut 2) 9.50 x 2.50mm	EACH	£12.70
113244	100mm (Cut 4) 9.50 x 2.50mm	EACH	£15.75
1132600	150mm (Cut 00) 12.00 x 4.00mm	EACH	£12.95
113260	150mm (Cut 0) 12.00 x 4.00mm	EACH	£13.95
113262	150mm (Cut 2) 12.00 x 4.00mm	EACH	£13.95
113264	150mm (Cut 4) 12.00 x 4.00mm	EACH	£17.25
113266	150mm (Cut 6) 12.00 x 4.00mm	EACH	£28.95
1132800	200mm (Cut 00) 14.50 x 4.50mm	EACH	£18.35
113280	200mm (Cut 0) 14.50 x 4.50mm	EACH	£18.90
113282	200mm (Cut 2) 14.50 x 4.50mm	EACH	£20.45
113283	200mm (Cut 3) 14.50 x 4.50mm	EACH	£21.65
113284	200mm (Cut 4) 14.50 x 4.50mm	EACH	£23.80
11321000	250mm (Cut 00) 17.50 x 5.30mm	EACH	£26.50
1132100	250mm (Cut 0) 17.50 x 5.30mm	EACH	£27.75
1132102	250mm (Cut 2) 17.50 x 5.30mm	EACH	£28.35
1132104	250mm (Cut 4) 17.50 x 5.30mm	EACH	£34.40
11321200	300mm (Cut 00) 19.3 x 6.3mm	EACH	£35.75
1132120	300mm (Cut 0) 19.3 x 6.3mm	EACH	£32.95
1132122	300mm (Cut 2) 19.3 x 6.3mm	EACH	£37.40

 IMPROVED  
SPEED SEARCH

## Pillar (1133) Vallorbe Swiss, Regular Smaller



Vallorbe 1133 - Swiss Made - Invest in the Best

Dimensions: Length (excludes Tang) x (Cut) x Section in mm

Pillar files are parallel in width and tapered in thickness for perfectly flat filing for precision work.

- With smaller proportions to 'regular' pillar hand files and having one blind edge.
- Made from chrome steel, hardness 65HRC +/-2
- Certified ISO 9001 / EN29001
- Cut = Higher the number, smoother (finer) the cut

For additional sizes please use our Online Support - Products & Stock - New Item Request

Code	Description	UOM	Price
113350	125mm (Cut 0) 10.50 x 3.50mm	EACH	£14.65
113361	150mm (Cut 1) 12.00 x 4.00mm	EACH	£15.50
113362	150mm (Cut 2) 12.00 x 4.00mm	EACH	£15.75
113363	150mm (Cut 3) 12.00 x 4.00mm	EACH	£17.65
113364	150mm (Cut 4) 12.00 x 4.00mm	EACH	£18.70
113380	200mm (Cut 0) 14.50 x 4.50mm	EACH	£19.50
113382	200mm (Cut 2) 14.50 x 4.50mm	EACH	£20.95
11331000	250mm (Cut 00) 17.50 x 5.30mm	EACH	£27.55

## Pillar (1138) Vallorbe Swiss, Regular Thin



Vallorbe 1138 - Swiss Made - Invest in the Best

Dimensions: Length (excludes Tang) x (Cut) x Section in mm

Pillar files are parallel in width and tapered in thickness for perfectly flat filing for precision work.

- Regular pillar (narrower than standard pillar) style with one blind edges
- Made from chrome steel, hardness 65HRC +/-2
- Certified ISO 9001 / EN29001
- Cut = Higher the number, smoother (finer) the cut

For additional sizes please use our Online Support - Products & Stock - New Item Request

Code	Description	UOM	Price
1138600	150mm (Cut 00) 10.5 x 2.4mm	EACH	£16.15
113860	150mm (Cut 0) 10.5 x 2.4mm	EACH	£16.95
113862	150mm (Cut 2) 10.5 x 2.4mm	EACH	£18.35
113864	150mm (Cut 4) 10.5 x 2.4mm	EACH	£24.75

### Piercing or Fret Saws & Blades

See Page 982



### Pillar (1142) Vallorbe Swiss, Slim



Vallorbe 1142 - Swiss Made - Invest in the Best

Dimensions: Length (excludes Tang) x (Cut) x Section in mm

Pillar files are parallel in width and tapered in thickness for perfectly flat filing for precision work.

- With two blind edges - improved access
- Made from chrome steel, hardness 65HRC +/-2
- Certified ISO 9001 / EN29001
- Cut = Higher the number, smoother (finer) the cut

For additional sizes please use our Online Support - Products & Stock - New Item Request

Code	Description	UOM	Price
114240	100mm (Cut 0) 4.60 x 2.20mm	EACH	£13.45
114242	100mm (Cut 2) 4.60 x 2.20mm	EACH	£14.50
114244	100mm (Cut 4) 4.60 x 2.20mm	EACH	£17.95
1142600	150mm (Cut 00) 6.50 x 3.00mm	EACH	£14.95
114260	150mm (Cut 0) 6.50 x 3.00mm	EACH	£15.85
114262	150mm (Cut 2) 6.50 x 3.00mm	EACH	£17.15
114264	150mm (Cut 4) 6.50 x 3.00mm	EACH	£18.95
114266	150mm (Cut 6) 6.50 x 3.00mm	EACH	£32.75
1142800	200mm (Cut 00) 8.30 x 3.80mm	EACH	£20.65
114280	200mm (Cut 0) 8.30 x 3.80mm	EACH	£21.85
114282	200mm (Cut 2) 8.30 x 3.80mm	EACH	£23.65
114284	200mm (Cut 4) 8.30 x 3.80mm	EACH	£27.55
1142100	250mm (Cut 0) 9.30 x 4.30mm	EACH	£32.75
1142102	250mm (Cut 2) 9.30 x 4.30mm	EACH	£35.50

### Pillar (1152) Vallorbe Swiss, Extra Slim



Vallorbe 1152 - Swiss Made - Invest in the Best

Dimensions: Length (excludes Tang) x (Cut) x Section in mm

Pillar files are parallel in width and tapered in thickness for perfectly flat filing for precision work.

- Very slim profile with two blind edges
- Made from chrome steel, hardness 65HRC +/-2
- Certified ISO 9001 / EN29001
- Cut = Higher the number, smoother (finer) the cut

For additional sizes please use our Online Support - Products & Stock - New Item Request

Code	Description	UOM	Price
115260	150mm (Cut 0) 4.5 x 2.5mm	EACH	£15.95
115262	150mm (Cut 2) 4.5 x 2.5mm	EACH	£17.05
115264	150mm (Cut 4) 4.5 x 2.5mm	EACH	£19.95
115266	150mm (Cut 6) 4.50 x 2.50mm	EACH	£18.80
11521000	250mm (Cut 00) 8.00 x 2.00mm	EACH	£27.25
1152102	250mm (Cut 2) 8.00 x 2.00mm	EACH	£27.75

### Pillar (1163\*) Cousins Euro, Standard

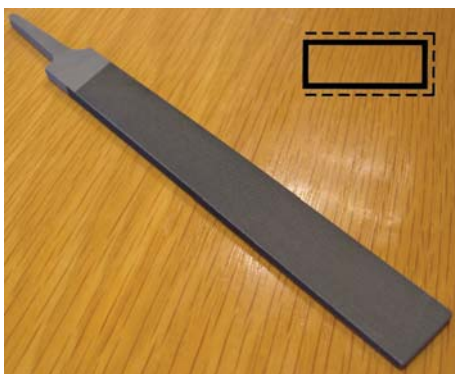

Cousins Files - EU Made - Invest in the Best

Dimensions: Length (excludes Tang) x (Cut) x Section in mm

Pillar files are parallel in width and tapered in thickness for perfectly flat filing for precision work.

- Standard (wider than regular) hand file with one blind edge
- Swiss Style\*
- Excellent Value

For additional sizes please use our Online Support - Products & Stock - New Item Request

Code	Description	UOM	Price
F35269	150mm (Cut 0) 18.00 x 3.80mm	EACH	£8.75
F35270	150mm (Cut 2) 18.00 x 3.80mm	EACH	£11.35
F35271	150mm (Cut 4) 18.00 x 3.80mm	EACH	£11.90

### Pillar (1163) Vallorbe Swiss, Standard



Vallorbe 1163 - Swiss Made - Invest in the Best

Dimensions: Length (excludes Tang) x (Cut) x Section in mm

Pillar files are parallel in width and tapered in thickness for perfectly flat filing for precision work.

- Standard (wider than regular) hand file with one blind edge
- Made from chrome steel, hardness 65HRC +/-2
- Certified ISO 9001 / EN29001
- Cut = Higher the number, smoother (finer) the cut

For additional sizes please use our Online Support - Products & Stock - New Item Request

Code	Description	UOM	Price
1163400	100mm (Cut 00) 12.50 x 3.00mm	EACH	£11.15
116340	100mm (Cut 0) 12.50 x 3.00mm	EACH	£11.30
116342	100mm (Cut 2) 12.50 x 3.00mm	EACH	£12.15
116343	100mm (Cut 3) 12.50 x 3.00mm	EACH	£13.45
116344	100mm (Cut 4) 12.50 x 3.00mm	EACH	£14.30
116346	100mm (Cut 6) 12.50 x 3.00mm	EACH	£24.25
116353	125mm (Cut 3) 15.50 x 3.50mm	EACH	£13.85
116354	125mm (Cut 4) 15.50 x 3.50mm	EACH	£15.95
116355	125mm (Cut 5) 15.50 x 3.50mm	EACH	£19.70
11636000	150mm (Cut 000) 18.50 x 4.00mm	EACH	£13.75
1163600	150mm (Cut 00) 18.50 x 4.00mm	EACH	£11.80
116360	150mm (Cut 0) 18.50 x 4.00mm	EACH	£9.90
116361	150mm (Cut 1) 18.50 x 4.00mm	EACH	£11.50
116362	150mm (Cut 2) 18.50 x 4.00mm	EACH	£11.95
116363	150mm (Cut 3) 18.50 x 4.00mm	EACH	£12.85
116364	150mm (Cut 4) 18.50 x 4.00mm	EACH	£12.65

116365	150mm (Cut 5) 18.50 x 4.00mm	EACH	£19.95
116366	150mm (Cut 6) 18.50 x 4.00mm	EACH	£29.60
116372	175mm (Cut 2) 21.30 x 4.80mm	EACH	£18.70
11638000	200mm (Cut 000) 21.30 x 4.80mm	EACH	£17.35
1163800	200mm (Cut 00) 21.30 x 4.80mm	EACH	£16.50
116380	200mm (Cut 0) 21.30 x 4.80mm	EACH	£17.25
116381	200mm (Cut 1) 21.30 x 4.80mm	EACH	£18.25
116382	200mm (Cut 2) 21.30 x 4.80mm	EACH	£20.15
116384	200mm (Cut 4) 21.30 x 4.80mm	EACH	£21.70
116386	200mm (Cut 6) 21.30 x 4.80mm	EACH	£37.10
11631000	250mm (Cut 00) 25.30 x 6.30mm	EACH	£23.80
1163100	250mm (Cut 0) 25.30 x 6.30mm	EACH	£24.75
1163101	250mm (Cut 1) 25.30 x 6.30mm	EACH	£25.85
1163102	250mm (Cut 2) 25.30 x 6.30mm	EACH	£26.80
1163103	250mm (Cut 3) 25.30 x 6.30mm	EACH	£30.75

### Pillar (1168) Vallorbe Swiss, Standard Thin



Vallorbe 1168 - Swiss Made - Invest in the Best

Dimensions: Length (excludes Tang) x (Cut) x Section in mm

Pillar files are parallel in width and tapered in thickness for perfectly flat filing for precision work.

- A flatter thinner file for greater access
- Made from chrome steel, hardness 65HRC +/-2
- Certified ISO 9001 / EN29001
- Cut = Higher the number, smoother (finer) the cut

For additional sizes please use our Online Support - Products & Stock - New Item Request

Code	Description	UOM	Price
116852	125mm (Cut 2) 14.50 x 1.70mm	EACH	£15.25
116860	150mm (Cut 0) 16.50 x 2.00mm	EACH	£17.95
116862	150mm (Cut 2) 16.50 x 2.00mm	EACH	£18.65
116864	150mm (Cut 4) 16.50 x 2.00mm	EACH	£22.35

### Pippin (1730) Vallorbe Swiss



Vallorbe 1730 - Swiss Made - Invest in the Best

Dimensions: Length (excludes Tang) x (Cut) x Section in mm

Pippin files are tapered in width and thickness, generally of a teardrop cross section and having the edge of a knife file. Used for filing the junction of two curved surfaces and making V-shaped slots.

- A flatter thinner file for greater access
- Made from chrome steel, hardness 65HRC +/-2
- Certified ISO 9001 / EN29001
- Cut = Higher the number, smoother (finer) the cut

For additional sizes please use our Online Support - Products & Stock - New Item Request

Code	Description	UOM	Price
1730062	150mm (Cut 2) 10.0 x 4.4mm	EACH	£46.95
1730064	150mm (Cut 4) 10.0 x 4.4mm	EACH	£54.95

### Round (1660) Vallorbe Swiss, Pointed



Vallorbe 1660 - Swiss Made - Invest in the Best

Dimensions: Length (excludes Tang) x (Cut) x Section in mm

- Pointed (Rat Tail) file for general use
- Made from chrome steel, hardness 65HRc +/-2
- Certified ISO 9001 / EN29001
- Cut = Higher the number, smoother (finer) the cut

For additional sizes please use our Online Support - Products & Stock - New Item Request

Code	Description	UOM	Price
166031	75mm (Cut 1) Maximum Ø3.0mm	EACH	£11.45
166042	100mm (Cut 2) Maximum Ø4.0mm	EACH	£11.75
166061	150mm (Cut 1) Maximum Ø6.0mm	EACH	£14.25
166062	150mm (Cut 2) Maximum Ø6.0mm	EACH	£13.45
166064	150mm (Cut 4) Maximum Ø6.0mm	EACH	£15.65
166066	150mm (Cut 6) Maximum Ø6.0mm	EACH	£26.95
166081	200mm (Cut 1) Maximum Ø8.0mm	EACH	£19.50
166082	200mm (Cut 2) Maximum Ø8.0mm	EACH	£19.95
166084	200mm (Cut 4) Maximum Ø8.0mm	EACH	£23.50

### Round (1666) Vallorbe Swiss, Slim Pointed



Vallorbe 1666 - Swiss Made - Invest in the Best

Dimensions: Length (excludes Tang) x (Cut) x Section in mm

- Pointed (Rat Tail) file for general use
- Made from chrome steel, hardness 65HRc +/-2
- Certified ISO 9001 / EN29001
- Cut = Higher the number, smoother (finer) the cut

For additional sizes please use our Online Support - Products & Stock - New Item Request

Code	Description	UOM	Price
1666032	75mm (Cut 2) Maximum Ø3.0mm	EACH	£12.85
1666034	75mm (Cut 4) Maximum Ø3.0mm	EACH	£14.75
1666042	100mm (Cut 2) Maximum Ø4.0mm	EACH	£13.75
1666062	150mm (Cut 2) Maximum Ø6.0mm	EACH	£16.15



### Round (1667) Vallorbe Swiss, Extra Slim



Vallorbe 1667 - Swiss Made - Invest in the Best

Dimensions: Length (excludes Tang) x (Cut) x Section in mm

- Fine gradual taper from 1.5mm down
- Made from chrome steel, hardness 65HRc +/-2
- Certified ISO 9001 / EN29001
- Cut = Higher the number, smoother (finer) the cut

For additional sizes please use our Online Support - Products & Stock - New Item Request

Code	Description	UOM	Price
166731	75mm (Cut 1) Maximum Ø1.5mm	EACH	£13.30
1667042	100mm (Cut 2) Maximum Ø4.0mm	EACH	£14.95
1667060	150mm (Cut 0) Maximum Ø6.0mm	EACH	£14.50
1667062	150mm (Cut 2) Maximum Ø6.0mm	EACH	£24.50

### Round (1669) Vallorbe Swiss, Parallel

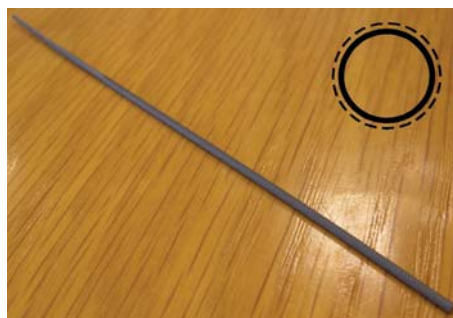

Vallorbe 1669 - Swiss Made - Invest in the Best

Dimensions: Length (excludes Tang) x (Cut) x Section in mm

Round parallel files are similar to round files, except that they do not taper. Shaped like a toothed cylinder.

- Non tapered rod form
- Made from chrome steel, hardness 65HRc +/-2
- Certified ISO 9001 / EN29001
- Cut = Higher the number, smoother (finer) the cut

For additional sizes please use our Online Support - Products & Stock - New Item Request

Code	Description	UOM	Price
16694016	100mm (Cut 0) Ø1.6mm	EACH	£11.50
16694043	100mm (Cut 0) Ø3.0mm	EACH	£11.75
16694216	100mm (Cut 2) Ø1.6mm	EACH	£12.95
1669423	100mm (Cut 2) Ø3.0mm	EACH	£14.50
166906224	150mm (Cut 2) Ø2.4mm	EACH	£14.75
166906232	150mm (Cut 2) Ø3.2mm	EACH	£14.75
16690624	150mm (Cut 2) Ø4.0mm	EACH	£13.50
166906248	150mm (Cut 2) Ø4.8mm	EACH	£17.10

Stone Setting  
Including  
Burnishers

See Page 1029



### Round Seconds Hole (1680) Vallorbe Swiss



Vallorbe 1680 - Swiss Made - Invest in the Best

Dimensions: Length (excludes Tang) x (Cut) x Section in mm

- Gradual taper to fine point for opening tiny round holes
- Made from chrome steel, hardness 65HRc +/-2
- Certified ISO 9001 / EN29001
- Cut = Higher the number, smoother (finer) the cut

For additional sizes please use our Online Support - Products & Stock - New Item Request

Code	Description	UOM	Price
1680152	38mm (Cut 2) Maximum Ø1.0mm	EACH	£9.35
1680154	38mm (Cut 4) Maximum Ø1.0mm	EACH	£11.35
168022	50mm (Cut 2) Maximum Ø1.0mm	EACH	£10.35
1680204	50mm (Cut 4) Maximum Ø1.0mm	EACH	£10.55
1680632	63mm (Cut 2) Maximum Ø1.6mm	EACH	£11.50
1680254	63mm (Cut 4) Maximum Ø1.6mm	EACH	£13.50

### Slitting (1860) Vallorbe Swiss, Screwhead Clock



Vallorbe 1860 - Swiss Made - Invest in the Best

Dimensions: Length (excludes Tang) x (Cut) x Section in mm

Slitting files are parallel in width with a diamond-shaped cross section. Thinner than knife files and use for filing slots.

- Made from chrome steel, hardness 65HRc +/-2
- Certified ISO 9001 / EN29001
- Cut = Higher the number, smoother (finer) the cut

For additional sizes please use our Online Support - Products & Stock - New Item Request

Code	Description	UOM	Price
1860060	150mm (Cut 0) 15.0 x 3.3mm	EACH	£36.15
1860062	150mm (Cut 2) 15.0 x 3.3mm	EACH	£39.35

The UK's  
Largest  
File Selection



### Slotting (1040) Vallorbe Swiss



Vallorbe 1040 - Swiss Made - Invest in the Best

Dimensions: Length (excludes Tang) x (Cut) x Section in mm

- Made from chrome steel, hardness 65HRC +/-2
- Certified ISO 9001 / EN29001
- Cut = Higher the number, smoother (finer) the cut

For additional sizes please use our Online Support - Products & Stock - New Item Request

Code	Description	UOM	Price
1040600	150mm (Cut 00) Maximum Slot 5.50mm	EACH	£8.95
104082	200mm (Cut 2) Maximum Slot 7.50mm	EACH	£13.80

### Slotting Screw Head (1840) Vallorbe Swiss, with Tang



Vallorbe 1840 - Swiss Made - Invest in the Best

Dimensions: Length (excludes Tang) x (Cut) x Section in mm

- For screw heads and fine grooving
- Files have only the very edge as a cutting surface
- Made from chrome steel, hardness 65HRC +/-2
- Certified ISO 9001 / EN29001
- Cut = Higher the number, smoother (finer) the cut
- Length 75mm
- Width 9mm

For additional sizes please use our Online Support - Products & Stock - New Item Request

Code	Description	UOM	Price
1840032	75mm (Cut 2) Width 9mm	EACH	£26.50
1840034	75mm (Cut 4) Width 9mm	EACH	£26.50
1840036	75mm (Cut 6) Width 9mm	EACH	£28.20
1840038	75mm (Cut 8) Width 9mm	EACH	£24.95
18400400	100mm (Cut 00) Width 11mm	EACH	£33.65

### Slotting Screw Head (1850) Vallorbe Swiss



Vallorbe 1850 - Swiss Made - Invest in the Best

Dimensions: Length (excludes Tang) x (Cut) x Section in mm

- For screw heads and fine grooving
- Files have only the very edge as a cutting surface
- Made from chrome steel, hardness 65HRC +/-2
- Certified ISO 9001 / EN29001
- Cut = Higher the number, smoother (finer) the cut
- Length 75mm
- Width 9mm

For additional sizes please use our Online Support - Products & Stock - New Item Request

Code	Description	UOM	Price
185032	75mm (Cut 2) Width 9mm	EACH	£27.75
185034	75mm (Cut 4) Width 9mm	EACH	£25.35
185035	75mm (Cut 5) Width 9mm	EACH	£27.75
185036	75mm (Cut 6) Width 9mm	EACH	£27.75
185038	75mm (Cut 8) Width 9mm	EACH	£27.75

### Square (1464) Vallorbe Swiss, Pointed



Vallorbe 1464 - Swiss Made - Invest in the Best

Dimensions: Length (excludes Tang) x (Cut) x Section in mm

- Pointed square section
- Made from chrome steel, hardness 65HRC +/-2
- Certified ISO 9001 / EN29001
- Cut = Higher the number, smoother (finer) the cut

For additional sizes please use our Online Support - Products & Stock - New Item Request

Code	Description	UOM	Price
14640352	90mm (Cut 2) Maximum 2.50mm	EACH	£14.50
146442	100mm (Cut 2) Maximum 3.60mm	EACH	£14.70
146462	150mm (Cut 2) Maximum 5.50mm	EACH	£16.95
146464	150mm (Cut 4) Maximum 5.50mm	EACH	£18.70

### Square Seconds Hole (1480) Vallorbe Swiss

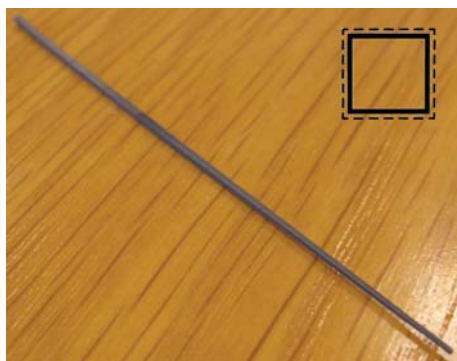

Vallorbe 1480 - Swiss Made - Invest in the Best

Dimensions: Length (excludes Tang) x (Cut) x Section in mm

- Gradual taper to fine point for opening tiny square/ rectangular holes
- Made from chrome steel, hardness 65HRC +/-2
- Certified ISO 9001 / EN29001
- Cut = Higher the number, smoother (finer) the cut

For additional sizes please use our Online Support - Products & Stock - New Item Request

Code	Description	UOM	Price
148023	50mm (Cut 3) Maximum 1.0mm	EACH	£28.65
1480024	50mm (Cut 4) Maximum 1.00mm	EACH	£28.65
1480026	50mm (Cut 6) Maximum 1.00mm	EACH	£34.95

### Triangular (1360) Vallorbe Swiss, Regular

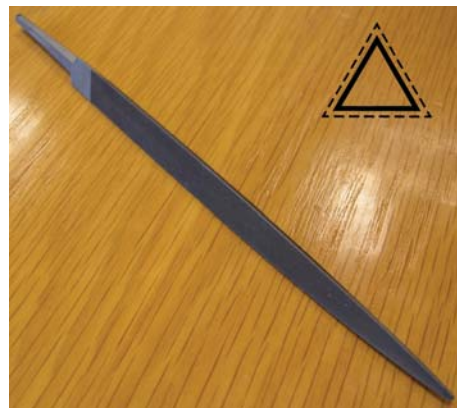

Vallorbe 1360 - Swiss Made - Invest in the Best

Dimensions: Length (excludes Tang) x (Cut) x Section in mm

- Normal proportions with 3 cutting faces
- Made from chrome steel, hardness 65HRC +/-2
- Certified ISO 9001 / EN29001
- Cut = Higher the number, smoother (finer) the cut

For additional sizes please use our Online Support - Products & Stock - New Item Request

Code	Description	UOM	Price
136042	100mm (Cut 2) Maximum 7.50mm	EACH	£19.95
136044	100mm (Cut 4) Maximum 7.50mm	EACH	£23.95
136053	125mm (Cut 3) Maximum 8.30mm	EACH	£19.60
13606000	150mm (Cut 000) Maximum 12.30mm	EACH	£20.95
1360600	150mm (Cut 00) Maximum 14.30mm	EACH	£13.95
136060	150mm (Cut 0) Maximum 10.30mm	EACH	£14.65
136061	150mm (Cut 1) Maximum 10.30mm	EACH	£15.75
136062	150mm (Cut 2) Maximum 10.30mm	EACH	£18.75
136064	150mm (Cut 4) Maximum 10.30mm	EACH	£22.75
136066	150mm (Cut 6) Maximum 10.30mm	EACH	£36.10
136074	175mm (Cut 4) Maximum 12.20mm	EACH	£28.50
1360800	200mm (Cut 00) Maximum 14.20mm	EACH	£28.95
136080	200mm (Cut 0) Maximum 14.20mm	EACH	£24.50
136081	200mm (Cut 1) Maximum 14.20mm	EACH	£26.50
136082	200mm (Cut 2) Maximum 14.20mm	EACH	£27.50

## File Cleaning Brush

**Ref: B33137**  
See Page: 799

### Triangular (1366) Vallorbe Swiss, Narrow

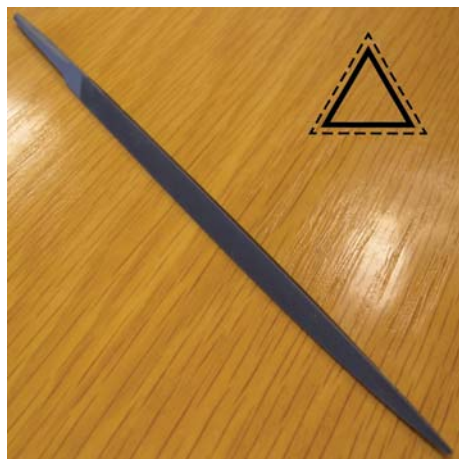

Vallorbe 1366 - Swiss Made - Invest in the Best

Dimensions: Length (excludes Tang) x (Cut) x Section in mm

- Three square narrow for easier access
- Made from chrome steel, hardness 65HRc +/-2
- Certified ISO 9001 / EN29001
- Cut = Higher the number, smoother (finer) the cut

For additional sizes please use our Online Support - Products & Stock - New Item Request

Code	Description	UOM	Price
1366600	150mm (Cut 00) Maximum 8.30mm	EACH	£20.95
136660	150mm (Cut 0) Maximum 8.30mm	EACH	£19.25
136661	150mm (Cut 1) Maximum 8.30mm	EACH	£23.30
136662	150mm (Cut 2) Maximum 8.30mm	EACH	£20.95
136682	200mm (Cut 2) Maximum 10.30mm	EACH	£32.95

### Triangular (1367) Vallorbe Swiss, Extra Narrow

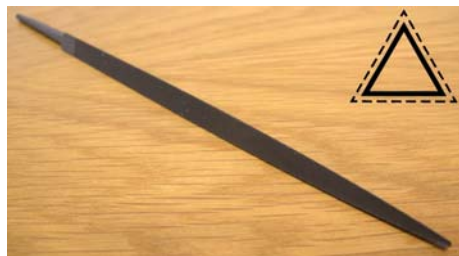

Vallorbe 1367 - Swiss Made - Invest in the Best

Dimensions: Length (excludes Tang) x (Cut) x Section in mm

- Three square narrow for easier access
- Made from chrome steel, hardness 65HRc +/-2
- Certified ISO 9001 / EN29001
- Cut = Higher the number, smoother (finer) the cut

For additional sizes please use our Online Support - Products & Stock - New Item Request

Code	Description	UOM	Price
136760	150mm (Cut 0) Maximum 7.5mm	EACH	£21.75
136762	150mm (Cut 2) Maximum 7.5mm	EACH	£24.35

### File Handles



Ref: H39453  
See Page: 917

### Warding (1263) Vallorbe Swiss



Vallorbe 1263 - Swiss Made - Invest in the Best

Dimensions: Length (excludes Tang) x (Cut) x Section in mm

Warding files are parallel in thickness, tapered in width, and thin. Like a hand or flat file that comes to a point on the end. Used for flat work and slotting.

- Flat section terminating in a point
- Made from chrome steel, hardness 65HRc +/-2
- Certified ISO 9001 / EN29001
- Cut = Higher the number, smoother (finer) the cut

For additional sizes please use our Online Support - Products & Stock - New Item Request

Code	Description	UOM	Price
126340	100mm (Cut 0) 12.4 x 2.5mm	EACH	£16.15
126342	100mm (Cut 2) 12.4 x 2.5mm	EACH	£17.75
126360	150mm (Cut 0) 15.40 x 3.50mm	EACH	£16.95
126362	150mm (Cut 2) 15.40 x 3.50mm	EACH	£21.15
126364	150mm (Cut 4) 15.40 x 3.50mm	EACH	£25.75
1263800	200mm (Cut 00) 21.40 x 5.00mm	EACH	£25.60
126380	200mm (Cut 0) 21.40 x 5.00mm	EACH	£26.60

### Warding (1265) Vallorbe Swiss, Special Thickness



Vallorbe 1265 - Swiss Made - Invest in the Best

Dimensions: Length (excludes Tang) x (Cut) x Section in mm\*

\*+0/-0.08mm

Warding files are parallel in thickness, tapered in width, and thin. Like a hand or flat file that comes to a point on the end. Used for flat work and slotting.

- Flat section terminating in a point
- Made from chrome steel, hardness 65HRc +/-2
- Certified ISO 9001 / EN29001
- Cut = Higher the number, smoother (finer) the cut

For additional sizes please use our Online Support - Products & Stock - New Item Request

Code	Description	UOM	Price
126504021	100mm (Cut 0) 12.40 x 0.81mm	EACH	£22.50
126506218	150mm (Cut 2) 15.40 x 1.25mm	EACH	£24.60

The UK's  
Largest  
File Selection

### Warding (1268) Vallorbe Swiss, Thin



Vallorbe 1268 - Swiss Made - Invest in the Best

Dimensions: Length (excludes Tang) x (Cut) x Section in mm

Warding files are parallel in thickness, tapered in width, and thin. Like a hand or flat file that comes to a point on the end. Used for flat work and slotting.

- Thin flat section terminating in a point
- Made from chrome steel, hardness 65HRc +/-2
- Certified ISO 9001 / EN29001
- Cut = Higher the number, smoother (finer) the cut

For additional sizes please use our Online Support - Products & Stock - New Item Request

Code	Description	UOM	Price
1268750	75mm (Cut 0) 9.00 x 0.60mm	EACH	£8.85
126832	75mm (Cut 2) 9.00 x 0.60mm	EACH	£9.20
1268062	150mm (Cut 2) 15.4 x 1.7mm	EACH	£20.50
1268064	150mm (Cut 4) 15.4 x 1.7mm	EACH	£23.30

## HAND FILES "HABILIS"

### Habilis Files, Diamond (Cousins Euro)



Cousins Files - EU Made - Invest in the Best

- Swiss Style\*
- Excellent Value
- Diamond impregnated
- Impressive files at a value price
- Dotted outer profiles on images indicate cutting faces

Diamond Habilis Files offer the crafts person the ultimate in production efficiency. The distinctive design includes a built in handle, so there is no separate handle to buy and they're shaped for easy handling and balanced for efficient cutting

Specifications:

- Cutting length 80mm
- Overall length is 210mm
- Supplied in grit 170
- Integral handle

Five Shapes:

- Half Round, Pillar, Round, Square, Triangle

Dimensions: Shape x (Cut) x Section in mm



**Flat (Diamond) 11.0 x 3.5mm**



Cousins Files - EU Made - Invest in the Best  
 • Swiss Style\*  
 • Excellent Value  
 • Diamond impregnated

Code	Description	UOM	Price
F33851	Flat (Diamond) 11.0 x 3.5mm	EACH	£9.50

**Half Round (Diamond) 10.5 x 4.4mm**



Cousins Files - EU Made - Invest in the Best  
 • Swiss Style\*  
 • Excellent Value  
 • Diamond impregnated

Code	Description	UOM	Price
F33852	Half Round (Diamond) 10.5 x 4.4mm	EACH	£9.50

**Round (Diamond) Maximum Ø5.0mm**



Cousins Files - EU Made - Invest in the Best  
 • Swiss Style\*  
 • Excellent Value  
 • Diamond impregnated

Code	Description	UOM	Price
F33853	Round (Diamond) Maximum Ø5.0mm	EACH	£9.50

**Square (Diamond) Maximum 6.3mm**



Cousins Files - EU Made - Invest in the Best  
 • Swiss Style\*  
 • Excellent Value  
 • Diamond impregnated

Code	Description	UOM	Price
F33855	Square (Diamond) Maximum 6.3mm	EACH	£9.50

**Triangle (Diamond) Maximum 7.7mm**



Cousins Files - EU Made - Invest in the Best  
 • Swiss Style\*  
 • Excellent Value  
 • Diamond impregnated

Code	Description	UOM	Price
F33854	Triangle (Diamond) Maximum 7.7mm	EACH	£9.50

***Habilis Files, Regular (Vallorbe Swiss)***



Vallorbe - Swiss Made - Invest in the Best

- Integral handle
- Made from chrome steel, hardness 65HRC +/-2
- Certified ISO 9001 / EN29001

Habilis files offer the craftsperson something different; precision files designed for those "in-between" jobs, too big for needle files and requiring finer control than a larger, heavier file can deliver.

The distinctive design includes a built-in handle, so there's no separate handle to buy and they're shaped for easy handling and balanced for efficient cutting. These strong, durable files are ideal for a variety of uses.

- Length of cuts is 100mm (4 inches)
- Overall length is 215mm (8½ inches)
- Supplied in Cut 1
- Dotted outer profiles on images indicate cutting faces

Five shapes:

- Half Round, Pillar, Round, Square, Triangle
- Dimensions: Shape x (Vallorbe Reference) x Section in mm

**Half Round (2602) 12.2 x 3.4mm**



- Vallorbe Swiss
- Length of cut 100mm (4 inches)
- Overall length 215mm (8½ inches)
- Cut 1
- Integral Handle

Code	Description	UOM	Price
26021	Half Round (2602) 12.2 x 3.4mm	EACH	£13.50

**Pillar (2601) 10.0 x 2.6mm**

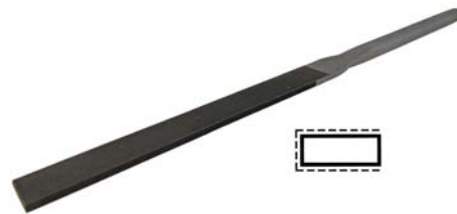

- Vallorbe Swiss
- Length of cut 100mm (4 inches)
- Overall length 215mm (8½ inches)
- Cut 1
- Integral Handle

Code	Description	UOM	Price
260161	Pillar (2601) 10.0 x 2.6mm	EACH	£15.95

**Round (2610) Maximum Ø6.5mm**



- Vallorbe Swiss
- Length of cut 100mm (4 inches)
- Overall length 215mm (8½ inches)
- Cut 1
- Integral Handle

Code	Description	UOM	Price
26101	Round (2610) Maximum Ø6.5mm	EACH	£9.45

**Square (2608) Maximum 5.8mm**



- Vallorbe Swiss
- Length of cut 100mm (4 inches)
- Overall length 215mm (8½ inches)
- Cut 1
- Integral Handle

Code	Description	UOM	Price
26081	Square (2608) Maximum 5.8mm	EACH	£17.45

**Triangle (2607) Maximum 9.4mm**



- Vallorbe Swiss
- Length of cut 100mm (4 inches)
- Overall length 220mm (8½ inches)
- Cut 1
- Integral Handle

Code	Description	UOM	Price
26071	Triangle (2607) Maximum 9.4mm	EACH	£18.45

Online Discounts

**PRICE PROMISE GUARANTEE**

Online Order Tracking

## NEEDLE FILES

vallorbe® / COUSINS  
swiss



Vallorbe - Swiss Made - Invest in the Best

- Knurled handles
- Made from chrome steel, hardness 65HRc +/-2
- Certified ISO 9001 / EN29001

All our files in the following sections and types are of superlative Swiss Vallorbe manufacturer. The quality is unrivalled and the range vast. Selection is only a matter of deciding on type, length-size and cut.

Fine and pointed, with tapered edges and sharp points, they are recommended for steel and steel alloys, soft metals and finishing work.

Cuts are expressed in numbers, they simply get finer as the number rises. Eg: 0=Coarse, 2=Medium, 4=Fine etc.

Dotted outer profiles on images indicate cutting faces.

For additional sizes please use our Online Support - Products & Stock - New Item Request

### Barrette (2411\*) Cousins Euro, Safety Back



Cousins Files - EU Made - Invest in the Best

Dimensions: Length x (Cut) x Section in mm

- Swiss Style\*
- Excellent Value

For additional sizes please use our Online Support - Products & Stock - New Item Request

Code	Description	UOM	Price
F35264	160mm (Cut 0) 5.0 x 2.0mm	EACH	£3.25
F35265	160mm (Cut 2) 5.0 x 2.0mm	EACH	£3.35
F35266	160mm (Cut 4) 5.0 x 2.0mm	EACH	£3.50
F35401	200mm (Cut 0) 6.0 x 2.5mm	EACH	£3.50
F35402	200mm (Cut 2) 6.0 x 2.5mm	EACH	£4.15
F35403	200mm (Cut 4) 6.0 x 2.5mm	EACH	£4.50

### Barrette (2411) Vallorbe Swiss, Safety Back



Vallorbe 2411 - Swiss Made - Invest in the Best

Dimensions: Length x (Cut) x Section in mm

- Made from chrome steel, hardness 65HRc +/-2
- Certified ISO 9001 / EN29001
- Cut = Higher the number, smoother (finer) the cut

For additional sizes please use our Online Support - Products & Stock - New Item Request

Code	Description	UOM	Price
24111000	100mm (Cut 0) 3.7 x 1.4mm	EACH	£6.75
24111002	100mm (Cut 2) 3.7 x 1.4mm	EACH	£6.50
24111004	100mm (Cut 4) 3.7 x 1.4mm	EACH	£8.95
24111400	140mm (Cut 0) 4.7 x 1.7mm	EACH	£5.65
24111402	140mm (Cut 2) 4.7 x 1.7mm	EACH	£5.75
24111403	140mm (Cut 3) 4.7 x 1.7mm	EACH	£5.95
24111404	140mm (Cut 4) 4.7 x 1.7mm	EACH	£6.50
241116000	160mm (Cut 00) 5.1 x 1.8mm	EACH	£6.30
24111600	160mm (Cut 0) 5.1 x 1.8mm	EACH	£6.30
24111601	160mm (Cut 1) 5.1 x 1.8mm	EACH	£6.30
24111602	160mm (Cut 2) 5.1 x 1.8mm	EACH	£6.30
24111604	160mm (Cut 4) 5.1 x 1.8mm	EACH	£6.30
24111606	160mm (Cut 6) 5.1 x 1.8mm	EACH	£9.95
24111800	180mm (Cut 0) 5.4 x 2.0mm	EACH	£7.25
24111802	180mm (Cut 2) 5.4 x 2.0mm	EACH	£7.25
24111804	180mm (Cut 4) 5.4 x 2.0mm	EACH	£7.95
241120000	200mm (Cut 00) 5.80 x 2.20mm	EACH	£7.85
24112000	200mm (Cut 0) 5.80 x 2.20mm	EACH	£7.50
24112002	200mm (Cut 2) 5.80 x 2.20mm	EACH	£6.50
24112004	200mm (Cut 4) 5.80 x 2.20mm	EACH	£8.40

### Contact Point (2420) Vallorbe Swiss



Vallorbe 2420 - Swiss Made - Invest in the Best

Dimensions: Length x (Cut) x Section in mm

- Made from chrome steel, hardness 65HRc +/-2
- Certified ISO 9001 / EN29001
- Cut = Higher the number, smoother (finer) the cut

For additional sizes please use our Online Support - Products & Stock - New Item Request

Code	Description	UOM	Price
24201300	130mm (Cut 0) 8.0 x 0.90mm	EACH	£6.35
24201302	130mm (Cut 2) 8.0 x 0.90mm	EACH	£6.95

### Crochet (2415) Vallorbe Swiss



Vallorbe 2415 - Swiss Made - Invest in the Best

Dimensions: Length x (Cut) x Section in mm

- Made from chrome steel, hardness 65HRc +/-2
- Certified ISO 9001 / EN29001
- Cut = Higher the number, smoother (finer) the cut

For additional sizes please use our Online Support - Products & Stock - New Item Request

Code	Description	UOM	Price
24151002	100mm (Cut 2) 3.7 x 1.0mm	EACH	£8.65
24151402	140mm (Cut 2) 4.8 x 1.2mm	EACH	£6.65
24151602	160mm (Cut 2) 5.4 x 1.3mm	EACH	£7.10
24151606	160mm (Cut 6) 5.4 x 1.3mm	EACH	£11.65
24152000	200mm (Cut 0) 6.5 x 1.5mm	EACH	£10.40

### Crossing (2403\*) Cousins Euro



Cousins Files - EU Made - Invest in the Best

Dimensions: Length x (Cut) x Section in mm

- Swiss Style\*
- Excellent Value

For additional sizes please use our Online Support - Products & Stock - New Item Request

Code	Description	UOM	Price
F35243	160mm (Cut 0) 4.7 x 2.1mm	EACH	£2.85
F35244	160mm (Cut 2) 4.7 x 2.1mm	EACH	£2.85
F35245	160mm (Cut 4) 4.7 x 2.1mm	EACH	£3.05
F35380	200mm (Cut 0) 6.0 x 2.5mm	EACH	£3.20
F35381	200mm (Cut 2) 6.0 x 2.5mm	EACH	£3.20
F35382	200mm (Cut 4) 6.0 x 2.5mm	EACH	£3.75

### Crossing (2403) Vallorbe Swiss



Vallorbe 2403 - Swiss Made - Invest in the Best

Dimensions: Length x (Cut) x Section in mm

- Made from chrome steel, hardness 65HRc +/-2
- Certified ISO 9001 / EN29001
- Cut = Higher the number, smoother (finer) the cut

For additional sizes please use our Online Support - Products & Stock - New Item Request

Code	Description	UOM	Price
24031002	100mm (Cut 2) 3.5 x 1.4mm	EACH	£11.30
24031004	100mm (Cut 4) 3.5 x 1.4mm	EACH	£12.95
24031400	140mm (Cut 0) 4.4 x 1.8mm	EACH	£8.95
24031402	140mm (Cut 2) 4.4 x 1.8mm	EACH	£8.50
24031404	140mm (Cut 4) 4.4 x 1.8mm	EACH	£8.55
24031405	140mm (Cut 5) 4.4 x 1.8mm	EACH	£8.75
240316000	160mm (Cut 00) 5.1 x 2.0mm	EACH	£7.80
24031600	160mm (Cut 0) 5.1 x 2.0mm	EACH	£7.80
24031601	160mm (Cut 1) 5.1 x 2.0mm	EACH	£9.50
24031602	160mm (Cut 2) 5.1 x 2.0mm	EACH	£7.80
24031603	160mm (Cut 3) 5.1 x 2.0mm	EACH	£7.80
24031604	160mm (Cut 4) 5.1 x 2.0mm	EACH	£7.80
24031606	160mm (Cut 6) 5.1 x 2.0mm	EACH	£13.30
24031800	180mm (Cut 0) 5.8 x 2.2mm	EACH	£10.85
24031802	180mm (Cut 2) 5.8 x 2.2mm	EACH	£10.85
24031804	180mm (Cut 4) 5.8 x 2.2mm	EACH	£11.75
240320000	200mm (Cut 00) 6.0 x 2.4mm	EACH	£11.75
24032000	200mm (Cut 0) 6.0 x 2.4mm	EACH	£11.95
24032001	200mm (Cut 1) 6.0 x 2.4mm	EACH	£11.95
24032002	200mm (Cut 2) 6.0 x 2.4mm	EACH	£9.95
24032004	200mm (Cut 4) 6.0 x 2.4mm	EACH	£11.25

### Half Round (2402\*) Cousins Euro



Cousins Files - EU Made - Invest in the Best

Dimensions: Length x (Cut) x Section in mm

- Swiss Style\*
- Excellent Value

For additional sizes please use our Online Support - Products & Stock - New Item Request

Code	Description	UOM	Price
F35240	160mm (Cut 0) 5.0 x 1.6mm	EACH	£3.25
F35241	160mm (Cut 2) 5.0 x 1.6mm	EACH	£4.15
F35242	160mm (Cut 4) 5.0 x 1.6mm	EACH	£3.85
F35377	200mm (Cut 0) 6.5 x 2.0mm	EACH	£3.55
F35378	200mm (Cut 2) 6.5 x 2.0mm	EACH	£3.95
F35379	200mm (Cut 4) 6.5 x 2.0mm	EACH	£4.15

### Half Round (2402) Vallorbe Swiss



Vallorbe 2402 - Swiss Made - Invest in the Best

Dimensions: Length x (Cut) x Section in mm

- Made from chrome steel, hardness 65HRC +/-2
- Certified ISO 9001 / EN29001
- Cut = Higher the number, smoother (finer) the cut

For additional sizes please use our Online Support - Products & Stock - New Item Request

Code	Description	UOM	Price
24021000	100mm (Cut 0) 3.8 x 1.1mm	EACH	£5.75
24021002	100mm (Cut 2) 3.8 x 1.1mm	EACH	£7.45
24021004	100mm (Cut 4) 3.8 x 1.1mm	EACH	£7.50
24021400	140mm (Cut 0) 5.1 x 1.5mm	EACH	£6.10
24021402	140mm (Cut 2) 5.1 x 1.5mm	EACH	£6.75
24021404	140mm (Cut 4) 5.1 x 1.5mm	EACH	£6.95
240216000	160mm (Cut 00) 5.6 x 1.7mm	EACH	£6.60
24021600	160mm (Cut 0) 5.6 x 1.7mm	EACH	£6.60
24021601	160mm (Cut 1) 5.6 x 1.7mm	EACH	£6.75
24021602	160mm (Cut 2) 5.6 x 1.7mm	EACH	£6.95
24021604	160mm (Cut 4) 5.6 x 1.7mm	EACH	£7.40
24021606	160mm (Cut 6) 5.6 x 1.7mm	EACH	£9.95
240218000	180mm (Cut 00) 5.9 x 2.0mm	EACH	£7.60
24021800	180mm (Cut 0) 5.9 x 2.0mm	EACH	£7.60
24021801	180mm (Cut 1) 5.9 x 2.0mm	EACH	£8.45
24021802	180mm (Cut 2) 5.9 x 2.0mm	EACH	£8.55
24021804	180mm (Cut 4) 5.9 x 2.0mm	EACH	£8.95
24022000	200mm (Cut 0) 6.3 x 2.0mm	EACH	£7.95
24022002	200mm (Cut 2) 6.3 x 2.0mm	EACH	£8.00
24022004	200mm (Cut 4) 6.3 x 2.0mm	EACH	£9.55

### Half Round (2418) Vallorbe Swiss, Cut on Back Only



Vallorbe 2418 - Swiss Made - Invest in the Best  
Dimensions: Length x (Cut) x Section in mm

- Made from chrome steel, hardness 65HRC +/-2
- Certified ISO 9001 / EN29001
- Cut = Higher the number, smoother (finer) the cut

For additional sizes please use our Online Support - Products & Stock - New Item Request

Code	Description	UOM	Price
24181004	100mm (Cut 0) 3.8 x 1.2mm	EACH	£10.10
24181402	140mm (Cut 2) 5.1 x 1.5mm	EACH	£6.50
24181404	140mm (Cut 4) 5.1 x 1.5mm	EACH	£7.85
24181600	160mm (Cut 0) 5.6 x 1.8mm	EACH	£7.95
24181602	160mm (Cut 2) 5.6 x 1.8mm	EACH	£6.95
24181604	160mm (Cut 4) 5.6 x 1.8mm	EACH	£8.95

### Joint (2417) Vallorbe Swiss, Round Edges



Vallorbe 2417 - Swiss Made - Invest in the Best  
Dimensions: Length x (Cut) x Section in mm

- Two rounded cutting edges
- Made from chrome steel, hardness 65HRC +/-2
- Certified ISO 9001 / EN29001
- Cut = Higher the number, smoother (finer) the cut

For additional sizes please use our Online Support - Products & Stock - New Item Request

Code	Description	UOM	Price
24171003	100mm (Cut 3) 3.8 x 1.0mm	EACH	£9.85
24171004	100mm (Cut 4) 3.8 x 1.0mm	EACH	£9.95
24171402	140mm (Cut 2) 4.8 x 1.2mm	EACH	£6.45
24171404	140mm (Cut 4) 4.8 x 1.2mm	EACH	£7.20
24171600	160mm (Cut 0) 5.4 x 1.3mm	EACH	£7.75
24171602	160mm (Cut 2) 5.4 x 1.3mm	EACH	£7.75
24171604	160mm (Cut 4) 5.4 x 1.3mm	EACH	£7.75

### Knife Edge (2405\*) Cousins Euro



Cousins Files - EU Made - Invest in the Best  
Dimensions: Length x (Cut) x Section in mm

- Swiss Style\*
- Excellent Value

For additional sizes please use our Online Support - Products & Stock - New Item Request

Code	Description	UOM	Price
F35246	160mm (Cut 0) 6.0 x 1.9mm	EACH	£2.85
F35247	160mm (Cut 2) 6.0 x 1.9mm	EACH	£3.60
F35248	160mm (Cut 4) 6.0 x 1.9mm	EACH	£3.90
F35383	200mm (Cut 0) 6.0 x 2.3mm	EACH	£3.35
F35384	200mm (Cut 2) 6.0 x 2.3mm	EACH	£3.55
F35385	200mm (Cut 4) 6.0 x 2.3mm	EACH	£4.15

### Knife Edge (2405) Vallorbe Swiss



Vallorbe 2405 - Swiss Made - Invest in the Best  
Dimensions: Length x (Cut) x Section in mm

- Made from chrome steel, hardness 65HRC +/-2
- Certified ISO 9001 / EN29001
- Cut = Higher the number, smoother (finer) the cut

For additional sizes please use our Online Support - Products & Stock - New Item Request

Code	Description	UOM	Price
24051002	100mm (Cut 2) 4.0 x 1.1mm	EACH	£9.40
24051004	100mm (Cut 4) 4.0 x 1.1mm	EACH	£10.65
24051400	140mm (Cut 0) 5.0 x 1.4mm	EACH	£7.75
24051402	140mm (Cut 2) 5.0 x 1.4mm	EACH	£7.05
24051403	140mm (Cut 3) 5.0 x 1.4mm	EACH	£7.50
24051404	140mm (Cut 4) 5.0 x 1.4mm	EACH	£7.70
240516000	160mm (Cut 00) 5.4 x 1.5mm	EACH	£6.45
24051600	160mm (Cut 0) 5.4 x 1.5mm	EACH	£7.35
24051602	160mm (Cut 2) 5.4 x 1.5mm	EACH	£7.35
24051604	160mm (Cut 4) 5.4 x 1.5mm	EACH	£7.35
24051606	160mm (Cut 6) 5.4 x 1.5mm	EACH	£11.50
24051800	180mm (Cut 0) 6.0 x 1.7mm	EACH	£8.45
24051802	180mm (Cut 2) 6.0 x 1.7mm	EACH	£9.10
24052002	200mm (Cut 2) 6.4 x 1.8mm	EACH	£9.20
24052004	200mm (Cut 4) 6.4 x 1.8mm	EACH	£11.75

### Oval (2409\*) Cousins Euro



Cousins Files - EU Made - Invest in the Best  
Dimensions: Length x (Cut) x Section in mm

- Swiss Style\*
- Excellent Value

For additional sizes please use our Online Support - Products & Stock - New Item Request

Code	Description	UOM	Price
F35258	160mm (Cut 0) 3.6 x 2.7mm	EACH	£2.65
F35259	160mm (Cut 2) 3.6 x 2.7mm	EACH	£2.65
F35260	160mm (Cut 4) 3.6 x 2.7mm	EACH	£3.15
F35395	200mm (Cut 0) 4.0 x 3.2mm	EACH	£2.85
F35396	200mm (Cut 2) 4.0 x 3.2mm	EACH	£2.85
F35397	200mm (Cut 4) 4.0 x 3.2mm	EACH	£3.35

The UK's Largest File Selection

### Oval (2409) Vallorbe Swiss



Vallorbe 2409 - Swiss Made - Invest in the Best  
Dimensions: Length x (Cut) x Section in mm

- Made from chrome steel, hardness 65HRC +/-2
- Certified ISO 9001 / EN29001
- Cut = Higher the number, smoother (finer) the cut

For additional sizes please use our Online Support - Products & Stock - New Item Request

Code	Description	UOM	Price
24091400	140mm (Cut 0) 3.5 x 2.4mm	EACH	£4.25
24091402	140mm (Cut 2) 3.5 x 2.4mm	EACH	£6.55
24091404	140mm (Cut 4) 3.5 x 2.4mm	EACH	£8.50
24091600	160mm (Cut 0) 3.9 x 2.5mm	EACH	£8.25
24091602	160mm (Cut 2) 3.9 x 2.5mm	EACH	£7.25
24091604	160mm (Cut 4) 3.9 x 2.5mm	EACH	£9.05
24091800	180mm (Cut 0) 4.2 x 2.8mm	EACH	£9.50
24091802	180mm (Cut 2) 4.2 x 2.8mm	EACH	£9.50
24092000	200mm (Cut 0) 4.4 x 2.9mm	EACH	£10.75
24092002	200mm (Cut 2) 4.4 x 2.9mm	EACH	£10.95

### Pillar (2401\*) Cousins Euro

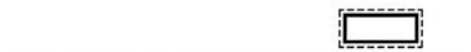

Cousins Files - EU Made - Invest in the Best  
Dimensions: Length x (Cut) x Section in mm

- Swiss Style\*
- Excellent Value

For additional sizes please use our Online Support - Products & Stock - New Item Request

Code	Description	UOM	Price
F35237	160mm (Cut 0) 6.0 x 1.2mm	EACH	£3.75
F35238	160mm (Cut 2) 6.0 x 1.2mm	EACH	£3.75
F35239	160mm (Cut 4) 6.0 x 1.2mm	EACH	£4.30
F35374	200mm (Cut 0) 6.5 x 1.6mm	EACH	£3.95
F35375	200mm (Cut 2) 6.5 x 1.6mm	EACH	£4.15
F35376	200mm (Cut 4) 6.5 x 1.6mm	EACH	£4.50

### Pillar (2401) Vallorbe Swiss



Vallorbe 2401 - Swiss Made - Invest in the Best  
Dimensions: Length x (Cut) x Section in mm

- Made from chrome steel, hardness 65HRC +/-2
- Certified ISO 9001 / EN29001
- Cut = Higher the number, smoother (finer) the cut

For additional sizes please use our Online Support - Products & Stock - New Item Request

Code	Description	UOM	Price
24011000	100mm (Cut 0) 3.5 x 0.90mm	EACH	£6.75
24011002	100mm (Cut 2) 3.5 x 0.90mm	EACH	£4.95
24011004	100mm (Cut 4) 3.5 x 0.90mm	EACH	£7.95
240114000	140mm (Cut 00) 4.8 x 1.1mm	EACH	£5.95
24011400	140mm (Cut 0) 4.8 x 1.1mm	EACH	£4.50
24011402	140mm (Cut 2) 4.8 x 1.1mm	EACH	£4.50
24011404	140mm (Cut 4) 4.8 x 1.1mm	EACH	£4.75
24011406	140mm (Cut 6) 4.8 x 1.1mm	EACH	£7.95
240116000	160mm (Cut 00) 5.4 x 1.2mm	EACH	£4.65
24011600	160mm (Cut 0) 5.4 x 1.2mm	EACH	£4.65
24011601	160mm (Cut 1) 5.4 x 1.2mm	EACH	£4.75
24011602	160mm (Cut 2) 5.4 x 1.2mm	EACH	£4.75
24011604	160mm (Cut 4) 5.4 x 1.2mm	EACH	£5.45
24011606	160mm (Cut 6) 5.4 x 1.2mm	EACH	£6.50
240118000	180mm (Cut 00) 6.0 x 1.3mm	EACH	£6.30
24011800	180mm (Cut 0) 6.0 x 1.3mm	EACH	£5.30

24011802	180mm (Cut 2) 6.0 x 1.3mm	EACH	£5.30
24011804	180mm (Cut 4) 6.0 x 1.3mm	EACH	£5.95
24012000	200mm (Cut 00) 6.5 x 1.3mm	EACH	£5.95
2401200	200mm (Cut 0) 6.5 x 1.3mm	EACH	£5.95
24012001	200mm (Cut 1) 6.5 x 1.3mm	EACH	£5.95
24012002	200mm (Cut 2) 6.5 x 1.3mm	EACH	£5.95
24012004	200mm (Cut 4) 6.5 x 1.3mm	EACH	£6.75

## Pillar (2416) Vallorbe Swiss, Round Edges

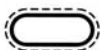

Vallorbe 2416 - Swiss Made - Invest in the Best

Dimensions: Length x (Cut) x Section in mm

Round-edge pillar files are double-cut on the flat sides and single-cut on the rounded edges. These are ideal for flat filing in squared-off spaces. The file thickness tapers toward the tip.

- Made from chrome steel, hardness 65HRC +/-2
- Certified ISO 9001 / EN29001
- Cut = Higher the number, smoother (finer) the cut

For additional sizes please use our Online Support - Products & Stock - New Item Request

Code	Description	UOM	Price
24161002	100mm (Cut 2) 3.8 x 1.0mm	EACH	£7.95
24161400	140mm (Cut 0) 4.8 x 1.2mm	EACH	£7.30
24161402	140mm (Cut 2) 4.8 x 1.2mm	EACH	£6.60
24161600	160mm (Cut 0) 5.4 x 1.3mm	EACH	£7.65
24161602	160mm (Cut 2) 5.4 x 1.3mm	EACH	£6.65
24161604	160mm (Cut 4) 5.4 x 1.3mm	EACH	£8.55
24161800	180mm (Cut 0) 6.0 x 1.4mm	EACH	£9.35
24161802	180mm (Cut 2) 6.0 x 1.4mm	EACH	£9.30
24162000	200mm (Cut 0) 6.5 x 1.5mm	EACH	£10.40

## Round (2410\*) Cousins Euro



Cousins Files - EU Made - Invest in the Best

Dimensions: Length x (Cut) x Section in mm

- Swiss Style\*
- Excellent Value
- Long gradual taper (rat tail type)

For additional sizes please use our Online Support - Products & Stock - New Item Request

Code	Description	UOM	Price
F35261	160mm (Cut 0) Maximum Ø3.1mm	EACH	£3.25
F35262	160mm (Cut 2) Maximum Ø3.1mm	EACH	£3.25
F35263	160mm (Cut 4) Maximum Ø3.1mm	EACH	£3.45
F35398	200mm (Cut 0) Maximum Ø3.3mm	EACH	£3.75
F35399	200mm (Cut 2) Maximum Ø3.3mm	EACH	£3.95
F35400	200mm (Cut 4) Maximum Ø3.3mm	EACH	£4.50

## Round (2410) Vallorbe Swiss



Vallorbe 2410 - Swiss Made - Invest in the Best

Dimensions: Length x (Cut) x Section in mm

- Long gradual taper (rat tail type)
- Made from chrome steel, hardness 65HRC +/-2
- Certified ISO 9001 / EN29001
- Cut = Higher the number, smoother (finer) the cut

**WORLDWIDE DELIVERY**

For additional sizes please use our Online Support - Products & Stock - New Item Request

Code	Description	UOM	Price
24101000	100mm (Cut 0) Maximum Ø2.1mm	EACH	£5.70
24101001	100mm (Cut 1) Maximum Ø2.1mm	EACH	£5.70
24101002	100mm (Cut 2) Maximum Ø2.1mm	EACH	£4.95
24101003	100mm (Cut 3) Maximum Ø2.1mm	EACH	£5.75
24101004	100mm (Cut 4) Maximum Ø2.1mm	EACH	£6.20
241014000	140mm (Cut 00) Maximum Ø2.8mm	EACH	£5.05
24101400	140mm (Cut 0) Maximum Ø2.8mm	EACH	£4.55
24101402	140mm (Cut 2) Maximum Ø2.8mm	EACH	£4.95
24101403	140mm (Cut 3) Maximum Ø2.8mm	EACH	£4.95
24101404	140mm (Cut 4) Maximum Ø2.8mm	EACH	£5.50
24101406	140mm (Cut 6) Maximum Ø2.8mm	EACH	£6.55
241016000	160mm (Cut 00) Maximum Ø2.9mm	EACH	£4.96
24101600	160mm (Cut 0) Maximum Ø2.9mm	EACH	£4.96
24101602	160mm (Cut 2) Maximum Ø2.9mm	EACH	£4.96
24101604	160mm (Cut 4) Maximum Ø2.9mm	EACH	£5.65
24101606	160mm (Cut 6) Maximum Ø2.9mm	EACH	£7.60
24101800	180mm (Cut 0) Maximum Ø3.2mm	EACH	£5.75
24101802	180mm (Cut 2) Maximum Ø3.2mm	EACH	£5.75
24101804	180mm (Cut 4) Maximum Ø3.2mm	EACH	£6.75
24102000	200mm (Cut 0) Maximum Ø3.5mm	EACH	£6.40
24102002	200mm (Cut 2) Maximum Ø3.5mm	EACH	£6.40
24102004	200mm (Cut 4) Maximum Ø3.5mm	EACH	£10.90

## Round (2423) Vallorbe Swiss, Extra Slim



Vallorbe 2423 - Swiss Made - Invest in the Best

Dimensions: Length x (Cut) x Section in mm

- Long gradual taper (rat tail type)
- Made from chrome steel, hardness 65HRC +/-2
- Certified ISO 9001 / EN29001
- Cut = Higher the number, smoother (finer) the cut

For additional sizes please use our Online Support - Products & Stock - New Item Request

Code	Description	UOM	Price
24231002	100mm (Cut 2) Maximum Ø1.0mm	EACH	£15.95

## Slitting (2414) Vallorbe Swiss



Vallorbe 2414 - Swiss Made - Invest in the Best

Dimensions: Length x (Cut) x Section in mm

- Made from chrome steel, hardness 65HRC +/-2
- Certified ISO 9001 / EN29001
- Cut = Higher the number, smoother (finer) the cut

For additional sizes please use our Online Support - Products & Stock - New Item Request

Code	Description	UOM	Price
24141000	100mm (Cut 0) 4.6 x 1.6mm	EACH	£9.25
24141002	100mm (Cut 2) 4.6 x 1.6mm	EACH	£9.25
24141400	140mm (Cut 0) 5.5 x 1.9mm	EACH	£7.35
24141402	140mm (Cut 2) 5.5 x 1.9mm	EACH	£7.15
24141404	140mm (Cut 4) 5.5 x 1.9mm	EACH	£8.30
24141600	160mm (Cut 0) 6.1 x 2.1mm	EACH	£7.55
24141602	160mm (Cut 2) 6.1 x 2.1mm	EACH	£7.95
24141604	160mm (Cut 4) 6.1 x 2.1mm	EACH	£9.30
24141606	160mm (Cut 6) 6.1 x 2.1mm	EACH	£11.10

**IMPROVED SPEED SEARCH**

[www.cousinsuk.com](http://www.cousinsuk.com)

## Square (2408\*) Cousins Euro



Cousins Files - EU Made - Invest in the Best

Dimensions: Length x (Cut) x Section in mm

- Swiss Style\*
- Excellent Value
- Long gradual taper (rat tail type)

For additional sizes please use our Online Support - Products & Stock - New Item Request

Code	Description	UOM	Price
F35255	160mm (Cut 0) Maximum 2.6mm	EACH	£2.75
F35256	160mm (Cut 2) Maximum 2.6mm	EACH	£3.50
F35257	160mm (Cut 4) Maximum 2.6mm	EACH	£3.50
F35392	200mm (Cut 0) Maximum 3.0mm	EACH	£3.10
F35393	200mm (Cut 2) Maximum 3.0mm	EACH	£3.25
F35394	200mm (Cut 4) Maximum 3.0mm	EACH	£3.75

## Square (2408) Vallorbe Swiss



Vallorbe 2408 - Swiss Made - Invest in the Best

Dimensions: Length x (Cut) x Section in mm

- Made from chrome steel, hardness 65HRC +/-2
- Certified ISO 9001 / EN29001
- Cut = Higher the number, smoother (finer) the cut

For additional sizes please use our Online Support - Products & Stock - New Item Request

Code	Description	UOM	Price
24081000	100mm (Cut 0) Maximum 1.7mm	EACH	£8.95
24081002	100mm (Cut 2) Maximum 1.7mm	EACH	£7.95
24081003	100mm (Cut 3) Maximum 1.7mm	EACH	£8.50
24081004	100mm (Cut 4) Maximum 1.7mm	EACH	£8.95
24081400	140mm (Cut 0) Maximum 2.2mm	EACH	£6.50
24081402	140mm (Cut 2) Maximum 2.2mm	EACH	£6.50
24081403	140mm (Cut 3) Maximum 2.2mm	EACH	£6.95
24081404	140mm (Cut 4) Maximum 2.2mm	EACH	£7.35
240816000	160mm (Cut 00) Maximum 2.4mm	EACH	£8.15
24081600	160mm (Cut 0) Maximum 2.4mm	EACH	£7.15
24081602	160mm (Cut 2) Maximum 2.4mm	EACH	£7.15
24081604	160mm (Cut 4) Maximum 2.4mm	EACH	£7.80
24081606	160mm (Cut 6) Maximum 2.4mm	EACH	£12.35
24081800	180mm (Cut 0) Maximum 2.6mm	EACH	£8.15
24081802	180mm (Cut 2) Maximum 2.6mm	EACH	£8.15
24081804	180mm (Cut 4) Maximum 2.6mm	EACH	£8.90
240820000	200mm (Cut 00) Maximum 2.8mm	EACH	£9.45
24082002	200mm (Cut 2) Maximum 2.8mm	EACH	£7.95
24082004	200mm (Cut 4) Maximum 2.8mm	EACH	£10.25

## Triangular (2407\*) Cousins Euro



Cousins Files - EU Made - Invest in the Best

Dimensions: Length x (Cut) x Section in mm

- Swiss Style\*
- Excellent Value
- Long gradual taper (rat tail type)

For additional sizes please use our Online Support - Products & Stock - New Item Request

Code	Description	UOM	Price
F35252	160mm (Cut 0) Maximum 3.6mm	EACH	£2.65
F35253	160mm (Cut 2) Maximum 3.6mm	EACH	£2.85
F35254	160mm (Cut 4) Maximum 3.6mm	EACH	£3.65
F35389	200mm (Cut 0) Maximum 4.3mm	EACH	£3.75
F35390	200mm (Cut 2) Maximum 4.3mm	EACH	£3.85
F35391	200mm (Cut 4) Maximum 4.3mm	EACH	£4.05

### Triangular (2407) Vallorbe Swiss



Vallorbe 2407 - Swiss Made - Invest in the Best

Dimensions: Length x (Cut) x Section in mm

- Made from chrome steel, hardness 65HRC +/-2
- Certified ISO 9001 / EN29001
- Cut = Higher the number, smoother (finer) the cut

For additional sizes please use our Online Support - Products & Stock - New Item Request

Code	Description	UOM	Price
24071000	100mm (Cut 0) Maximum 2.8mm	EACH	£7.95
24071002	100mm (Cut 2) Maximum 2.8mm	EACH	£6.95
24071004	100mm (Cut 4) Maximum 2.8mm	EACH	£7.75
240714000	140mm (Cut 00) Maximum 3.5mm	EACH	£6.10
24071400	140mm (Cut 0) Maximum 3.5mm	EACH	£6.10
24071402	140mm (Cut 2) Maximum 3.5mm	EACH	£5.95
24071404	140mm (Cut 4) Maximum 3.5mm	EACH	£6.55
24071406	140mm (Cut 6) Maximum 3.5mm	EACH	£10.15
240716000	160mm (Cut 00) Maximum 3.8mm	EACH	£6.50
24071600	160mm (Cut 0) Maximum 3.8mm	EACH	£6.50
24071601	160mm (Cut 1) Maximum 3.8mm	EACH	£6.65
24071602	160mm (Cut 2) Maximum 3.8mm	EACH	£6.50
24071604	160mm (Cut 4) Maximum 3.8mm	EACH	£7.15
24071606	160mm (Cut 6) Maximum 3.8mm	EACH	£10.50
24071800	180mm (Cut 0) Maximum 4.2mm	EACH	£7.35
24071802	180mm (Cut 2) Maximum 4.2mm	EACH	£7.35
24071804	180mm (Cut 4) Maximum 4.2mm	EACH	£7.95
240720000	200mm (Cut 00) Maximum 4.4mm	EACH	£7.95
24072000	200mm (Cut 0) Maximum 4.4mm	EACH	£7.95
24072001	200mm (Cut 1) Maximum 4.4mm	EACH	£7.95
24072002	200mm (Cut 2) Maximum 4.4mm	EACH	£7.95
24072003	200mm (Cut 3) Maximum 4.4mm	EACH	£8.65
24072004	200mm (Cut 4) Maximum 4.4mm	EACH	£8.95

### Warding (2406\*) Cousins Euro



Cousins Files - EU Made - Invest in the Best

Dimensions: Length x (Cut) x Section in mm

- Swiss Style\*
- Excellent Value
- Long gradual taper (rat tail type)

For additional sizes please use our Online Support - Products & Stock - New Item Request

Code	Description	UOM	Price
F35249	160mm (Cut 0) 5.9 x 1.4mm	EACH	£2.75
F35250	160mm (Cut 2) 5.9 x 1.4mm	EACH	£3.50
F35251	160mm (Cut 4) 5.9 x 1.4mm	EACH	£4.75
F35386	200mm (Cut 0) 6.5 x 1.6mm	EACH	£4.75
F35387	200mm (Cut 2) 6.5 x 1.6mm	EACH	£4.70
F35388	200mm (Cut 4) 6.5 x 1.6mm	EACH	£4.90

### Warding (2406) Vallorbe Swiss



Vallorbe 2406 - Swiss Made - Invest in the Best

Dimensions: Length x (Cut) x Section in mm

- Made from chrome steel, hardness 65HRC +/-2
- Certified ISO 9001 / EN29001
- Cut = Higher the number, smoother (finer) the cut

For additional sizes please use our Online Support - Products & Stock - New Item Request

Code	Description	UOM	Price
24061002	100mm (Cut 2) 3.4 x 0.9mm	EACH	£8.10

24061402	140mm (Cut 2) 4.8 x 1.1mm	EACH	£5.70
24061404	140mm (Cut 4) 4.8 x 1.1mm	EACH	£6.30
24061601	160mm (Cut 1) 5.4 x 1.2mm	EACH	£6.75
24061602	160mm (Cut 2) 5.4 x 1.2mm	EACH	£6.85
24061603	160mm (Cut 3) 5.4 x 1.2mm	EACH	£7.15
24061604	160mm (Cut 4) 5.4 x 1.2mm	EACH	£7.95
24061606	160mm (Cut 6) 5.4 x 1.2mm	EACH	£10.75
24061800	180mm (Cut 0) 6.0 x 1.2mm	EACH	£7.00
24061802	180mm (Cut 2) 6.0 x 1.2mm	EACH	£7.00
24061804	180mm (Cut 4) 6.0 x 1.2mm	EACH	£8.95
24062000	200mm (Cut 0) 6.5 x 1.4mm	EACH	£8.10
24062002	200mm (Cut 2) 6.5 x 1.4mm	EACH	£9.50
24062004	200mm (Cut 4) 6.5 x 1.4mm	EACH	£10.50

## NEEDLE FILES, DIAMOND IMPREGNATED



Diamond impregnated hand tools are used all over the world in many industries. There are various qualities in diamond files and should be used accordingly for the standard of work being done. Cousins Material House offers a comprehensive range of diamond files in various shapes and sizes

- This enables the end user to choose the most suitable file for any given application, including hard reaching areas.
- File quickly with accuracy on both push and pull strokes.
- Use to smooth contours, remove unwanted solder applying texture and to shape many metals.
- Diamond files can be used on many materials such as, platinum, palladium, gold, silver, steel, copper, brass, stone, ceramics, iron, tin, glass, zinc, pewter, aluminium, lead and bronze.
- File before you test any precious metal using Diamond Files will take down thick plate to expose a plated item.

Vallorbe Swiss Diamond files are considered to be the best in the world and are of an extreme high quality. Made for a Precision extra long life, construction consists of a smooth metal bonded diamond impregnation.

Cousins Material House diamond files are for the price exceptional quality and are smooth to medium diamond impregnation.

## Online Discounts

Diamond Coated Burr Sets & Individuals

See Page 802



### A\*F Swiss Diamond Needle Files



A\*F Swiss - Invest in the Best

Dimensions: Shape x (Length) x Section in mm

Diamond files are ideal for work with ceramics, glass and hard and ultra-hard materials. Produced with the same outlines as standard needle files, they are characterised by a very fine point, sharp edges and a long service life.

- Set of 5
- Consist of Pillar, Half Round, Round, Square, Triangle
- Available individually
- Grit 120 - 140 (General Use)
- Good quality with red plastified handles
- Length 140mm
- Working Length 60mm

For additional sizes please use our Online Support - Products & Stock - New Item Request

Code	Description	UOM	Price
F12151	Set of 5 Diamond Files, A*F Swiss	PACK*5	£26.50
F12155	Half Round (140mm) 5.4 x 1.9mm	EACH	£8.15
F12156	Pillar (140mm) 5.9 x 1.5mm	EACH	£8.75
F12154	Round (140mm) Maximum Ø3.3mm	EACH	£7.15
F12153	Square (140mm) Maximum 2.8mm	EACH	£7.35
F12152	Triangular (140mm) Maximum 3.9mm	EACH	£6.95

### Cousins Diamond Needle Files



Cousins UK - Invest in the Best

Dimensions: Shape x (Length) x Section in mm

Diamond files are ideal for work with ceramics, glass and hard and ultra-hard materials. Produced with the same outlines as standard needle files, they are characterised by a very fine point, sharp edges and a long service life.

- Set of 5
- Consist of Pillar, Half Round, Round, Square, Triangle
- Available individually
- Grit 120 - 140 (General Use)
- Good quality with red plastified handles
- Length 140mm
- Working Length 50mm

For additional sizes please use our Online Support - Products & Stock - New Item Request

Code	Description	UOM	Price
F32990	Set of 5 Cousins Diamond Files	PACK*5	£3.95
F32977	Half Round (140mm) 5.6 x 1.9mm	EACH	£1.95
F32975	Pillar (140mm) 6.2 x 1.4mm	EACH	£1.95
F32978	Round (140mm) Maximum Ø3.2mm	EACH	£1.95
F32980	Square (140mm) Maximum 3.0mm	EACH	£1.95
F32979	Triangle (140mm) Maximum 4.2mm	EACH	£1.95

## Vallorbe Swiss Diamond Needle Files, Classic



Vallorbe DA9470.91 Classic - Swiss - Invest in the Best  
Dimensions: Length x (Cut) x Section in mm

Diamond files are ideal for work with ceramics, glass and hard and ultra-hard materials. Produced with the same outlines as standard needle files, they are characterised by a very fine point, sharp edges and a long service life.

- 5 popular shapes and sizes
- Works well with platinum
- Length 140mm
- Cut D91: for Finishing

Set Contents:

- Half Round (DA9402)
- Pillar (DA9401)
- Round (DA9410)
- Square (DA9408)
- Three Square (DA9407)

For additional sizes please use our Online Support - Products & Stock - New Item Request

Code	Description	UOM	Price
947091	Set of 5 (DA9470.91) Vallorbe Classic	PACK*5	£159.95
940291	Half Round (DA9402.91) 5.4 x 2.0mm	EACH	£32.95

## Vallorbe Swiss Diamond Needle Files, Premium



Vallorbe DA8401, 8408 - Swiss - Invest in the Best  
Dimensions: Length x (Cut) x Section in mm

Diamond files are ideal for work with ceramics, glass and hard and ultra-hard materials. Produced with the same outlines as standard needle files, they are characterised by a very fine point, sharp edges and a long service life.

- Premium range
- Superior quality diamond coating
- Extended durability
- Works well with platinum
- Length 140mm
- Cut 126 for general use

For additional sizes please use our Online Support - Products & Stock - New Item Request

Code	Description	UOM	Price
8401126	Pillar (DA8401.126) 5.2 x 1.6mm	EACH	£39.95
8408126	Square (DA8408.126) Maximum 2.6mm	EACH	£39.95



**SAME DAY DISPATCH**

Solder Scraper Tool

See Page 905



## NEEDLE FILE SETS



Vallorbe - Swiss Made - Invest in the Best

- Made from chrome steel, hardness 65HRc +/-2
- Certified ISO 9001 / EN29001

Cousinsuk Euro Files

- Excellent value
- This range has a excellent cutting pattern perfect for the standard cost repair/manufacturing work.
- Quality grade steel used assuring you good usage
- Available in various cuts 0, 2 and 4

Far East

- Great for hobbyist/beginners
- Will do the job
- A budget set

Cuts are expressed in numbers, they simply get finer as the number rises. Eg: 0=Coarse, 2=Medium, 4=Fine etc.

Dotted outer profiles on images indicate cutting faces.

## A\*F Swiss, Set of 12



A\*F Swiss

Popular set of assorted economical files, medium cut with knurled handles. Ideal for hobbyists, students, schools, colleges, etc.

- 140mm length
- Popular shapes
- Medium cut

Code	Description	UOM	Price
F47541	Needle File Set, A*F Swiss	EACH	£11.50

Needle File Handle

See Page 916



## Cousins Euro, Set of 6

Cousins UK - Invest in the Best

- European Made Needle File Set
- Super value
- Excellent cutting pattern
- Perfect for the standard cost repair/manufacturing works
- All include a sectioned wallet.

Contents:

- Barrette
- Half Round
- Pillar
- Round
- Square
- Three Square



Code	Description	UOM	Price
F35404	Cut 0 (Length 160mm)	PACK*6	£11.85
F35405	Cut 2 (Length 160mm)	PACK*6	£12.30
F35406	Cut 4 (Length 160mm)	PACK*6	£13.75

## Vallorbe Swiss, Set of 6

Vallorbe - Swiss Made - 2442, 2443 - Invest in the Best

- Knurled handle
- Made from chrome steel, hardness 65HRc +/-2
- Certified ISO 9001 / EN29001
- Set of 6 in a popular range of shapes and sizes
- All include a sectioned wallet.

Contents:

- Half Round (2402)
- Pillar (2401)
- Round (2410)
- Square (2408)
- Three Square (2407)
- Warding (2406)

Dimensions: Length x Cut

Code	Description	UOM	Price
24421400	140mm (Cut 0) Vallorbe 2442	PACK*6	£30.25
24421402	140mm (Cut 2) Vallorbe 2442	PACK*6	£33.25
24430600	160mm (Cut 0) Vallorbe 2443	PACK*6	£36.50
24431602	160mm (Cut 2) Vallorbe 2443	PACK*6	£36.95
24441800	180mm (Cut 0) Vallorbe 2444	PACK*6	£54.95
24441802	180mm (Cut 2) Vallorbe 2444	PACK*6	£54.95
24452000	200mm (Cut 0) Vallorbe 2445	PACK*6	£62.30
24452002	200mm (Cut 2) Vallorbe 2445	PACK*6	£62.30

## Vallorbe Swiss, Set of 6 (Classic / Midget)



Vallorbe LAM020 - Swiss Made - Invest in the Best

The "Classic / Midget" sets are lighter construction & less durable.

- Knurled handle
- Made from chrome steel, hardness 65HRc +/-2



- Certified ISO 9001 / EN29001
- Set of 6 in a popular range of shapes and sizes
- Vallorbe Midget Needle File Set
- Lighter construction / less durable
- All include a sectioned wallet.

Contents:

- Half Round (LAM002)
- Pillar (LAM001)
- Round (LAM010)
- Square (LAM008)
- Three Square (LAM007)
- Warding (LAM006)

Code	Description	UOM	Price
F9455	140mm (Cut 0) Lighter Construction	PACK*6	£19.50
F9456	140mm (Cut 2) Lighter Construction	PACK*6	£22.85
F32066	160mm (Cut 0) Lighter Construction	PACK*6	£24.95
F9457	160mm (Cut 2) Lighter Construction	PACK*6	£24.95

### Vallorbe Swiss, Set of 12



Vallorbe - Swiss Made - 2482, 2483, 2484, 2485 - Invest in the Best

- Knurled handle
- Made from chrome steel, hardness 65HRC +/-2
- Certified ISO 9001 / EN29001
- 12 Vallorbe Swiss files in a comprehensive range of shapes and sizes
- All include a sectioned wallet.

Contents:

- Barrette (2411)
- Crochet (2415)
- Crossing (2403)
- Half Round (2402)
- Knife (2405)
- Oval (2409)
- Pillar (2401)
- Pillar Round Edges (2416)
- Round (2410)
- Square (2408)
- Three Square (2407)
- Warding (2406)

Code	Description	UOM	Price
24821400	140mm (Cut 0) Vallorbe 2482	PACK*12	£79.95
24821402	140mm (Cut 2) Vallorbe 2482	PACK*12	£72.50
24821404	140mm (Cut 4) Vallorbe 2482	PACK*12	£114.95
24831600	160mm (Cut 0) Vallorbe 2483	PACK*12	£99.95
24831602	160mm (Cut 2) Vallorbe 2483	PACK*12	£89.95
24831604	160mm (Cut 4) Vallorbe 2483	PACK*12	£117.95
LA24850	200mm (Cut 0) Vallorbe 2485	PACK*12	£147.95

### Vallorbe Swiss, Set of 12, in Plastic Box

Vallorbe - Swiss Made - 2492, 2493 - Invest in the Best



- Knurled handle
- Made from chrome steel, hardness 65HRC +/-2
- Certified ISO 9001 / EN29001
- 12 Vallorbe Swiss files in a comprehensive range of shapes and sizes
- All include a plastic storage box

Contents:

- Barrette (2411)
- Crochet (2415)
- Crossing (2403)
- Half Round (2402)
- Knife (2405)
- Oval (2409)
- Pillar (2401)
- Pillar Round Edges (2416)
- Round (2410)
- Square (2408)
- Three Square (2407)
- Warding (2406)

Code	Description	UOM	Price
LA24924	140mm (Cut 4) Vallorbe 2494	PACK*12	£99.95
LA24934	160mm (Cut 4) Vallorbe 2493	PACK*12	£99.95

### Value, Set of 4



Value Set - Invest in the Best

Ideal for wax model making will give a semi/smooth finish plus also very useful for removing suspected plated items before you test to buy precious metals.

- Exceptional value
- 140mm length
- Cut 0
- Red plastic handles

Contains: pillar, half round, square, triangle

Code	Description	UOM	Price
F32973	140mm OL, Cut 0, Set of 4	PACK*4	£3.95

## RIFFLER FILES

Vallorbe - Swiss Made - Invest in the Best

- Square middle handle
- Made from chrome steel, hardness 65HRC +/-2
- Certified ISO 9001 / EN29001

All our files in the following sections and types are of superlative Swiss Vallorbe manufacturer. The quality is unrivalled and the range vast. Selection is only a matter of deciding on type, length-size and cut.

Cuts are expressed in numbers, they simply get finer as the number rises. Eg: 0=Coarse, 2=Medium, 4=Fine etc.

Dotted outer profiles on images indicate cutting faces.

### Riffler 150mm Files, Vallorbe Swiss



Vallorbe - Swiss Made - Invest in the Best

Dimensions: Shape x (Vallorbe Reference & Cut) x Section in mm\*

\*Section sizes are approximate and at the widest or largest point

- Square central handle
- Made from chrome steel, hardness 66HRC
- Certified ISO 9001 / EN29001
- Length 150mm

With their long square section central handle and wide choice of shapes, Rifflers are for working surfaces and contours which are hard to access. Particularly recommended for engravers, carvers and goldsmiths also used by die makers, silversmiths and for intricate woodcarving.

Dotted outer profiles on images indicate cutting faces.

\*Most Popular Shapes:

- 1st - Rectangle (129152)
- 2nd - Square (129302)
- 3rd - Triangle (129422)
- 4th - Knife (129512)
- 5th - Round (129812)

### Half Round (12962, Cut 2) 4.5 x 1.6mm



Vallorbe - Swiss Made

- Made from chrome steel, hardness 66HRC
- Certified ISO 9001 / EN29001
- Half Round Section
- Overall Length 150mm
- Cut 2

Code	Description	UOM	Price
129622	Half Round (12962, Cut 2) 4.5 x 1.6mm	EACH	£16.35

### Half Round (12963, Cut 2) 4.5 x 1.4mm



Vallorbe - Swiss Made

- Made from chrome steel, hardness 66HRC
- Certified ISO 9001 / EN29001
- Half Round Section
- Overall Length 150mm
- Cut 2

Code	Description	UOM	Price
129632	Half Round (12963, Cut 2) 4.5 x 1.4mm	EACH	£18.75

The UK's  
Largest  
File Selection

### Half Round (12964, Cut 2) 4.7 x 1.4mm

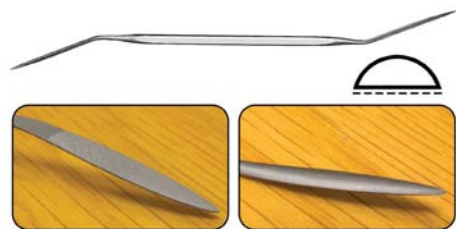

- Vallorbe - Swiss Made
- Made from chrome steel, hardness 66HRc
  - Certified ISO 9001 / EN29001
  - Half Round Section
  - Overall Length 150mm
  - Cut 2

Code	Description	UOM	Price
129642	Half Round (12964, Cut 2) 4.7 x 1.4mm	EACH	£15.25

### Half Round (12965)



- Vallorbe - Swiss Made
- Made from chrome steel, hardness 66HRc
  - Certified ISO 9001 / EN29001
  - Knife Section
  - Overall Length 150mm
  - Cut 2

Code	Description	UOM	Price
129652	Half Round (12965)	EACH	£14.95

### Knife (12951, Cut 0) 4.4 x 1.2 x 0.70mm



- Vallorbe - Swiss Made
- Made from chrome steel, hardness 66HRc
  - Certified ISO 9001 / EN29001
  - Knife Section
  - Overall Length 150mm
  - Cut 0

Code	Description	UOM	Price
129510	Knife (12951, Cut 0) 4.4 x 1.2 x 0.70mm	EACH	£23.75

### Knife (12951, Cut 2) 4.4 x 1.2 x 0.70mm (4th\*)



- Vallorbe - Swiss Made
- Made from chrome steel, hardness 66HRc
  - Certified ISO 9001 / EN29001
  - Knife Section
  - Overall Length 150mm

• Cut 2

Code	Description	UOM	Price
129512	Knife (12951, Cut 2) 4.4 x 1.2 x 0.70mm (4th*)	EACH	£30.55

### Knife (12951, Cut 4) 4.4 x 1.2 x 0.70mm



- Vallorbe - Swiss Made
- Made from chrome steel, hardness 66HRc
  - Certified ISO 9001 / EN29001
  - Knife Section
  - Overall Length 150mm
  - Cut 4

Code	Description	UOM	Price
129514	Knife (12951, Cut 4) 4.4 x 1.2 x 0.70mm	EACH	£26.95

### Knife (12952, Cut 2) 4.4 x 1.2 x 0.70mm



- Vallorbe - Swiss Made
- Made from chrome steel, hardness 66HRc
  - Certified ISO 9001 / EN29001
  - Knife Section
  - Overall Length 150mm
  - Cut 2

Code	Description	UOM	Price
129522	Knife (12952, Cut 2) 4.4 x 1.2 x 0.70mm	EACH	£33.15

### Knife (12953, Cut 2) 2.5 x 1.0mm

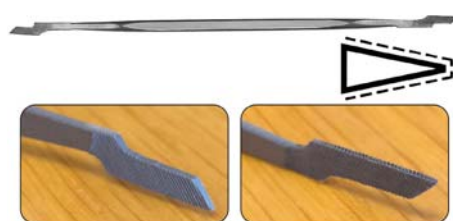

- Vallorbe - Swiss Made
- Made from chrome steel, hardness 66HRc
  - Certified ISO 9001 / EN29001
  - Knife Section
  - Overall Length 150mm
  - Cut 2

Code	Description	UOM	Price
129532	Knife (12953, Cut 2) 2.5 x 1.0mm	EACH	£25.65

Brush for  
Cleaning Files

See Page 799



### Knife (12955, Cut 2) 4.7 x 1.4 x 0.70mm



- Vallorbe - Swiss Made
- Made from chrome steel, hardness 66HRc
  - Certified ISO 9001 / EN29001
  - Knife Section
  - Overall Length 150mm
  - Cut 2

Code	Description	UOM	Price
129552	Knife (12955, Cut 2) 4.7 x 1.4 x 0.70mm	EACH	£23.05

### Knife (12956, Cut 2) 1.1mm



- Vallorbe - Swiss Made
- Made from chrome steel, hardness 66HRc
  - Certified ISO 9001 / EN29001
  - Knife section, flat cutting edge
  - Overall Length 150mm
  - Cut 2

Code	Description	UOM	Price
129562	Knife (12956, Cut 2) 1.1mm	EACH	£15.75

### Knife (12957, Cut 2) 1.1mm



- Vallorbe - Swiss Made
- Made from chrome steel, hardness 66HRc
  - Certified ISO 9001 / EN29001
  - Knife section, rounded cutting edge
  - Overall Length 150mm
  - Cut 2

Code	Description	UOM	Price
129572	Knife (12957, Cut 2) 1.1mm	EACH	£17.15

### Oval (12972, Cut 0) 4.0 x 1.8mm



- Vallorbe - Swiss Made
- Made from chrome steel, hardness 66HRc
  - Certified ISO 9001 / EN29001
  - Oval Section
  - Overall Length 150mm
  - Cut 0

Code	Description	UOM	Price
129720	Oval (12972, Cut 0) 4.0 x 1.8mm	EACH	£17.95

**Oval (12972, Cut 2) 4.0 x 1.8mm**



- Vallorbe - Swiss Made
- Made from chrome steel, hardness 66HRc
  - Certified ISO 9001 / EN29001
  - Oval Section
  - Overall Length 150mm
  - Cut 2

Code	Description	UOM	Price
129722	Oval (12972, Cut 2) 4.0 x 1.8mm	EACH	£16.60

**Oval (12972, Cut 4) 4.0 x 1.8mm**



- Vallorbe - Swiss Made
- Made from chrome steel, hardness 66HRc
  - Certified ISO 9001 / EN29001
  - Oval Section
  - Overall Length 150mm
  - Cut 4

Code	Description	UOM	Price
129724	Oval (12972, Cut 4) 4.0 x 1.8mm	EACH	£20.30

**Oval (12973, Cut 2) 4.0 x 1.8mm**



- Vallorbe - Swiss Made
- Made from chrome steel, hardness 66HRc
  - Certified ISO 9001 / EN29001
  - Oval Section
  - Overall Length 150mm
  - Cut 2

Code	Description	UOM	Price
129732	Oval (12973, Cut 2) 4.0 x 1.8mm	EACH	£16.35

**Oval (12974, Cut 2) 4.0 x 1.8mm**

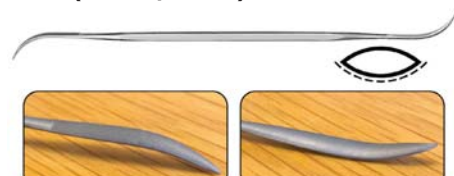

- Vallorbe - Swiss Made
- Made from chrome steel, hardness 66HRc
  - Certified ISO 9001 / EN29001
  - Oval Section
  - Overall Length 150mm
  - Cut 2

Code	Description	UOM	Price
129742	Oval (12974, Cut 2) 4.0 x 1.8mm	EACH	£15.95

**Oval (12975, Cut 2) 4.0 x 1.9mm**



- Vallorbe - Swiss Made
- Made from chrome steel, hardness 66HRc
  - Certified ISO 9001 / EN29001
  - Oval Section
  - Overall Length 150mm
  - Cut 2

Code	Description	UOM	Price
129752	Oval (12975, Cut 2) 4.0 x 1.9mm	EACH	£15.95

**Rectangle (12914, Cut 2) 3.5 x 1.5mm**



- Vallorbe - Swiss Made
- Made from chrome steel, hardness 66HRc
  - Certified ISO 9001 / EN29001
  - Rectangle Section
  - Overall Length 150mm
  - Cut 2

Code	Description	UOM	Price
129142	Rectangle (12914, Cut 2) 3.5 x 1.5mm	EACH	£16.35

**Rectangle (12915, Cut 0) 3.5 x 1.5mm**



- Vallorbe - Swiss Made
- Made from chrome steel, hardness 66HRc
  - Certified ISO 9001 / EN29001
  - Rectangle Section
  - Overall Length 150mm
  - Cut 0

Code	Description	UOM	Price
129150	Rectangle (12915, Cut 0) 3.5 x 1.5mm	EACH	£17.65

**Rectangle (12915, Cut 2) 3.5 x 1.5mm, Best Seller**



- Vallorbe - Swiss Made
- Made from chrome steel, hardness 66HRc
  - Certified ISO 9001 / EN29001
  - Rectangle Section
  - Overall Length 150mm

• Cut 2

Code	Description	UOM	Price
129152	Rectangle (12915, Cut 2) 3.5 x 1.5mm, Best Seller	EACH	£16.50

**Rectangle (12915, Cut 4) 3.5 x 1.5mm**



- Vallorbe - Swiss Made
- Made from chrome steel, hardness 66HRc
  - Certified ISO 9001 / EN29001
  - Rectangle Section
  - Overall Length 150mm
  - Cut 4

Code	Description	UOM	Price
129154	Rectangle (12915, Cut 4) 3.5 x 1.5mm	EACH	£23.50

**Round (12981, Cut 0) Ø3.1mm, 30° Curve**

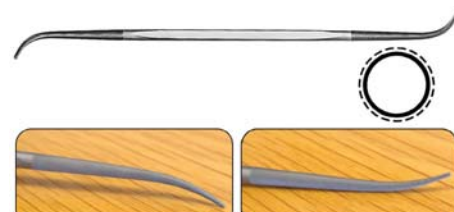

- Vallorbe - Swiss Made
- Made from chrome steel, hardness 66HRc
  - Certified ISO 9001 / EN29001
  - Round Section
  - Overall Length 150mm
  - Cut 0

Code	Description	UOM	Price
129810	Round (12981, Cut 0) Ø3.1mm, 30° Curve	EACH	£14.95

**Round (12981, Cut 2) Ø3.1mm, 30° Curve (5th\*)**

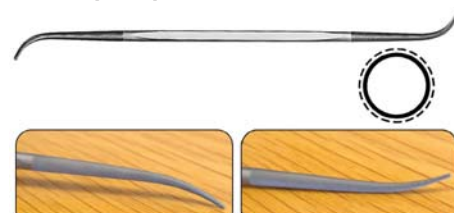

- Vallorbe - Swiss Made
- Made from chrome steel, hardness 66HRc
  - Certified ISO 9001 / EN29001
  - Round Section
  - Overall Length 150mm
  - Cut 2

Code	Description	UOM	Price
129812	Round (12981, Cut 2) Ø3.1mm, 30° Curve (5th*)	EACH	£15.25

www. Online Discounts

The UK's Largest File Selection

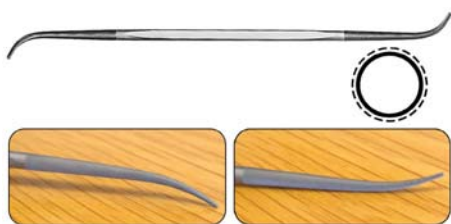
**Round (12981, Cut 4) Ø3.1mm, 30° Curve**

Vallorbe - Swiss Made

- Made from chrome steel, hardness 66HRc
- Certified ISO 9001 / EN29001
- Round Section
- Overall Length 150mm
- Cut 4

Code	Description	UOM	Price
129814	Round (12981, Cut 4) Ø3.1mm, 30° Curve	EACH	£18.15

**Round (12982, Cut 2) Ø3.1mm**

Vallorbe - Swiss Made

- Made from chrome steel, hardness 66HRc
- Certified ISO 9001 / EN29001
- Round Section
- Overall Length 150mm
- Cut 2

Code	Description	UOM	Price
129822	Round (12982, Cut 2) Ø3.1mm	EACH	£15.60

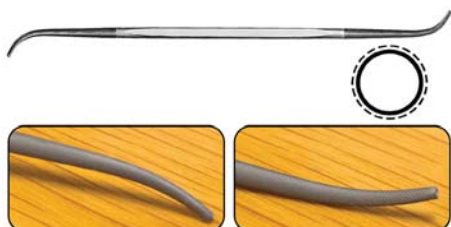
**Round (12983, Cut 0) Ø3.30mm**

Code	Description	UOM	Price
129830	Round (12983, Cut 0) Ø3.30mm	EACH	£14.95

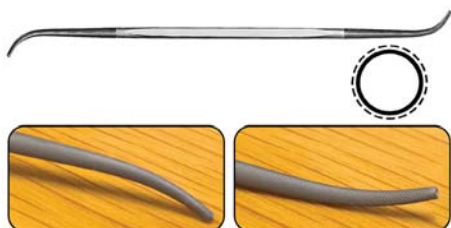
**Round (12983, Cut 2) Ø3.3mm**

Vallorbe - Swiss Made

- Made from chrome steel, hardness 66HRc
- Certified ISO 9001 / EN29001
- Round Section
- Overall Length 150mm
- Cut 2

Code	Description	UOM	Price
129832	Round (12983, Cut 2) Ø3.3mm	EACH	£15.45

**Round (12983, Cut 4) Ø3.30mm**

Code	Description	UOM	Price
129834	Round (12983, Cut 4) Ø3.30mm	EACH	£20.95

**Round (12985, Cut 2) Ø3.25mm**

Vallorbe - Swiss Made

- Made from chrome steel, hardness 66HRc
- Certified ISO 9001 / EN29001
- Round Section
- Overall Length 150mm
- Cut 2

Code	Description	UOM	Price
129852	Round (12985, Cut 2) Ø3.25mm	EACH	£15.45

**Round (12988, Cut 2) Ø3.25mm**

Vallorbe - Swiss Made

- Made from chrome steel, hardness 66HRc
- Certified ISO 9001 / EN29001
- Round Section
- Overall Length 150mm
- Cut 2

Code	Description	UOM	Price
129882	Round (12988, Cut 2) Ø3.25mm	EACH	£15.65

**Square (12930, Cut 0) 2.5mm**

Vallorbe - Swiss Made - 12930

- Made from chrome steel, hardness 66HRc
- Certified ISO 9001 / EN29001
- Square Section
- Overall Length 150mm
- Cut 0

Code	Description	UOM	Price
129300	Square (12930, Cut 0) 2.5mm	EACH	£17.30

**Cutting &  
Smoothing  
Broaches**

See Page 795

**Square (12930, Cut 2) 2.5mm (2nd\*)**

Vallorbe - Swiss Made - 12930

- Made from chrome steel, hardness 66HRc
- Certified ISO 9001 / EN29001
- Square Section
- Overall Length 150mm
- Cut 2

Code	Description	UOM	Price
129302	Square (12930, Cut 2) 2.5mm (2nd*)	EACH	£16.35

**Square (12930, Cut 4) 2.5mm**

Vallorbe - Swiss Made - 12930

- Made from chrome steel, hardness 66HRc
- Certified ISO 9001 / EN29001
- Square Section
- Overall Length 150mm
- Cut 4

Code	Description	UOM	Price
129304	Square (12930, Cut 4) 2.5mm	EACH	£22.75

**Trapezoid (12900, Cut 2) 2.9mm**

Vallorbe 12900 - Swiss Made

- Made from chrome steel, hardness 66HRc
- Certified ISO 9001 / EN29001
- Triangle Section
- Overall Length 150mm
- Cut 2

Code	Description	UOM	Price
129002	Trapezoid (12900, Cut 2) 2.9mm	EACH	£17.35

**Triangle (12942, Cut 0) 3.0mm**

Vallorbe - Swiss Made

- Made from chrome steel, hardness 66HRc
- Certified ISO 9001 / EN29001
- Triangle Section
- Overall Length 150mm
- Cut 0

Code	Description	UOM	Price
129420	Triangle (12942, Cut 0) 3.0mm	EACH	£19.95

**Triangle (12942, Cut 2) 3.0mm (3rd\*)**



Vallorbe - Swiss Made  
 • Made from chrome steel, hardness 66HRc  
 • Certified ISO 9001 / EN29001  
 • Triangle Section  
 • Overall Length 150mm  
 • Cut 2

Code	Description	UOM	Price
129422	Triangle (12942, Cut 2) 3.0mm (3rd*)	EACH	£26.85

**Triangle (12942, Cut 4) 3.0mm**



Vallorbe - Swiss Made  
 • Made from chrome steel, hardness 66HRc  
 • Certified ISO 9001 / EN29001  
 • Triangle Section  
 • Overall Length 150mm  
 • Cut 4

Code	Description	UOM	Price
129424	Triangle (12942, Cut 4) 3.0mm	EACH	£22.95

**Triangle (12943, Cut 2) 3.4mm**

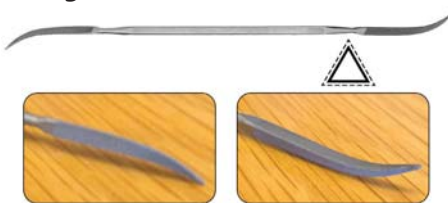

Vallorbe - Swiss Made  
 • Made from chrome steel, hardness 66HRc  
 • Certified ISO 9001 / EN29001  
 • Triangle Section  
 • Overall Length 150mm  
 • Cut 2

Code	Description	UOM	Price
129432	Triangle (12943, Cut 2) 3.4mm	EACH	£28.15

**Riffler 180mm Files, Vallorbe Swiss**

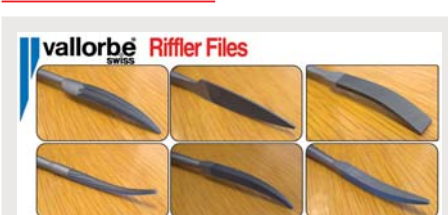

Vallorbe - Swiss Made - Invest in the Best Dimensions: Shape x (Vallorbe Reference) x Section in mm\*  
 \*Section sizes are approximate and at the widest or largest point  
 • Square central handle

- Made from chrome steel, hardness 66HRc
- Certified ISO 9001 / EN29001
- Length 180mm
- Cut 2

With their long square section central handle and wide choice of shapes, Rifflers are for working surfaces and contours which are hard to access. Particularly recommended for engravers, carvers and goldsmiths also used by die makers, silversmiths and for intricate woodcarving.

Dotted outer profiles on images indicate cutting faces.

**Half Round (12763) 9.2 x 3.6mm**



Vallorbe - Swiss Made  
 • Made from chrome steel, hardness 66HRc  
 • Certified ISO 9001 / EN29001  
 • Triangle Section  
 • Overall Length 180mm  
 • Cut 2

Code	Description	UOM	Price
127632	Half Round (12763) 9.2 x 3.6mm	EACH	£25.95

**Knife (127500) 10.4 x 2.7mm**



Vallorbe - Swiss Made  
 • Made from chrome steel, hardness 66HRc  
 • Certified ISO 9001 / EN29001  
 • Triangle Section  
 • Overall Length 180mm  
 • Cut 2

Code	Description	UOM	Price
127502	Knife (127500) 10.4 x 2.7mm	EACH	£27.50

**Rectangle (12711) 8.3 x 2.4mm**



Vallorbe - Swiss Made  
 • Made from chrome steel, hardness 66HRc  
 • Certified ISO 9001 / EN29001  
 • Triangle Section  
 • Overall Length 180mm  
 • Cut 2

Code	Description	UOM	Price
127112	Rectangle (12711) 8.3 x 2.4mm	EACH	£22.45



**Round (12781) Ø4.8mm**

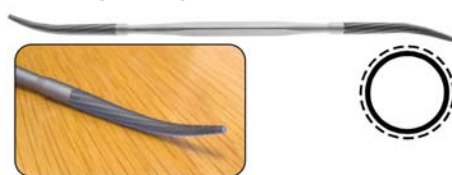

Vallorbe - Swiss Made  
 • Made from chrome steel, hardness 66HRc  
 • Certified ISO 9001 / EN29001  
 • Triangle Section  
 • Overall Length 180mm  
 • Cut 2

Code	Description	UOM	Price
127812	Round (12781) Ø4.8mm	EACH	£19.25

**Square (12731) 4.7mm**



Vallorbe - Swiss Made  
 • Made from chrome steel, hardness 66HRc  
 • Certified ISO 9001 / EN29001  
 • Triangle Section  
 • Overall Length 180mm  
 • Cut 2

Code	Description	UOM	Price
127312	Square (12731) 4.7mm	EACH	£23.65

**Triangle (12741) 7.4mm**



Vallorbe - Swiss Made  
 • Made from chrome steel, hardness 66HRc  
 • Certified ISO 9001 / EN29001  
 • Triangle Section  
 • Overall Length 180mm  
 • Cut 2

Code	Description	UOM	Price
127412	Triangle (12741) 7.4mm	EACH	£27.25

**Riffler File Sets, Vallorbe Swiss**



Vallorbe - Swiss Made - Invest in the Best

With their long square section central handle and wide choice of shapes, Rifflers are for working surfaces and contours which are hard to access. Particularly recommended for engravers, carvers and goldsmiths

also used by die makers, silversmiths and for intricate woodcarving.

- Square central handle
- Made from chrome steel, hardness 66HRc
- Certified ISO 9001 / EN29001
- Cut 2

150mm Set of 6:

- 12915, 12930, 12942, 12952, 12963, 12981

180mm Set of 6:

- 12711, 12731, 12741, 12750, 12763, 12781

Code	Description	UOM	Price
121562	150mm Riffler Files, Set of 6	PACK*6	£143.95
121862	180mm Riffler Files, Set of 6	PACK*6	£199.95

### Riffler File Sets, Value



With their long square section central handle and wide choice of shapes, Rifflers are used by die makers, silversmiths and for intricate woodcarving and wax working

- Riffler file set
- Set of 12
- Overall length 14cm
- Coarse cut

Code	Description	UOM	Price
F39452	Riffler Files Set	PACK*12	£8.95

### Riffler File Sets, Diamond Impregnated



Rifflers are used by die makers, silversmiths and for intricate woodcarving and wax working

- Riffler file set
- Set of 5
- Diamond impregnated
- Single end
- Overall length 15cm
- PVC coated handles for comfort

Code	Description	UOM	Price
F47508	Diamond Riffler Files Set	PACK*5	£9.95

PRICE PROMISE  GUARANTEE

### Planishing Blocks

See Page 882



## PIVOT FILES, BURNISHERS & FILE SETS



Vallorbe - Swiss Made - Invest in the Best

- Made from chrome steel, hardness 65HRc +/-2
- Certified ISO 9001 / EN29001

All our files in the following sections and types are of superlative Swiss Vallorbe manufacturer. The quality is unrivalled and the range vast. Selection is only a matter of deciding on type, length-size and cut.

Cuts are expressed in numbers, they simply get finer as the number rises. Eg: 0=Coarse, 2=Medium, 4=Fine etc.

Dotted outer profiles on images indicate cutting faces.

### Pivot File Burnishers, Bergeon



Burnishers for balance staffs and wheels, rectangular hard metal.

- Bergeon Swiss
- Length 165mm
- Working length 46mm
- Width 4.5mm
- Edge: R 0.1mm
- Right Handed, Bergeon 2933D
- Left handed, Bergeon 2933G

Code	Description	UOM	Price
B4192	Burnisher (Right Hand), Bergeon 2933D	EACH	£87.75
B33496	Burnisher (Left Hand), Bergeon 2933G	EACH	£87.75

### Brush for Cleaning Files

See Page 799



### Abrasive Blocks

See Page 1144

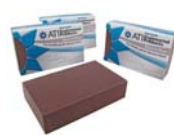

### Pivot File & Burnisher, Vallorbe Swiss

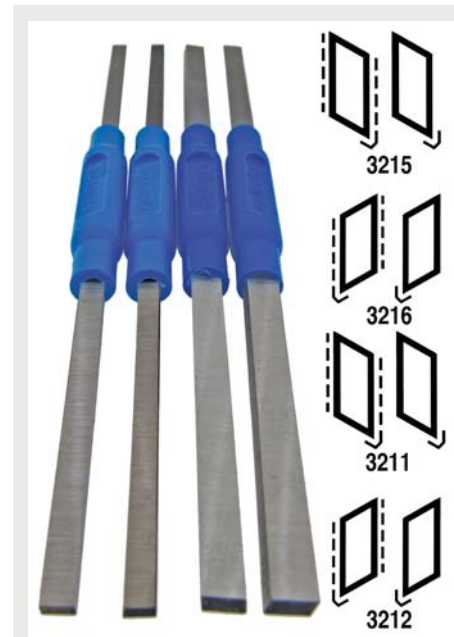

Pivot File & Burnisher

Vallorbe Swiss Made: one file end for final finishing the other hardened steel burnisher for mirror finish polish.

- The diagrams are as if holding the tool to use, looking down the file or burnisher
- Each file and burnisher have one rounded safety edge

### 4.5mm Left Angle, Pivot File & Burnisher



- Vallorbe 3215
- 4.5mm x 2mm
- Left Angle
- 180mm Length

Code	Description	UOM	Price
3215	4.5mm Left Angle, Pivot File & Burnisher	EACH	£42.95

### 4.5mm Right Angle, Pivot File & Burnisher



- Vallorbe 3216
- 4.5mm x 2mm
- Right Angle
- 180mm Length

Code	Description	UOM	Price
3216	4.5mm Right Angle, Pivot File & Burnisher	EACH	£42.95

### Pin Chuck Adaptor & Collets

See Page 938



**6.0mm Left Angle, Pivot File & Burnisher**



- Vallorbe 3211
- 6.0mm x 3mm
- Left Angle
- 180mm Length

Code	Description	UOM	Price
3211	6.0mm Left Angle, Pivot File & Burnisher	EACH	£42.95

**6.0mm Right Angle, Pivot File & Burnisher**



- Vallorbe 3212
- 6.0mm x 3mm
- Right Angle
- 180mm Length

Code	Description	UOM	Price
3212	6.0mm Right Angle, Pivot File & Burnisher	EACH	£42.95

**Oval Burnisher, Vallorbe**



- Vallorbe Swiss 0788
- Oval
- 100mm (4") Length
- 8mm Width
- 3.5mm Thick

Code	Description	UOM	Price
B0234	Oval Burnisher, Vallorbe	EACH	£10.95

**Set of Engineers Files, Vallorbe Swiss**



- Vallorbe - Swiss Made - Engineers Files
- Made from chrome steel, hardness 65HRc +/-2
  - Certified ISO 9001 / EN29001
  - Set of 6 general purpose coarse files
  - All have fitted plastic handle
  - Cutting length 8" (approx)
  - Overall length 12" (approx)

- Set includes:
- Flat (coarse)
  - Flat (medium)
  - Warding
  - Half round
  - Square
  - Round

Code	Description	UOM	Price
F9458	Engineers File Set	PACK*6	£35.95



**Set of Hobby Files**

Hooby File Set

- Super value
- Excellent cutting pattern
- Perfect for the standard cost repair/manufacturing works
- Supplied in a sectioned wallet
- 160mm Overall length



Contents:

- Pillar with Safety edge
- Half Round
- Pillar
- Round
- Square
- Three Square

Code	Description	UOM	Price
F39455	160mm OL, Set of 6	PACK*6	£9.95

**FORMING TOOLS**

**ANVILS**

An anvil is an important bench craft persons basic tool, a block with a hard surface on which another object is struck. The inertia of the anvil allows the energy of the striking tool to be transferred to the work piece. In most cases the anvil is used as a forming tool. Before the advent of modern soldering/welding technology, it was a primary tool of metal workers. Because anvils are very ancient tools and were at one time very commonplace, they have also acquired symbolic meaning beyond their use as utilitarian objects.

We have large selection of anvils in stock from mini to large made from best grade steels and exceptional polished finishing.

The majority of our anvils also have a pritchel hole. A pritchel hole is a round hole in an anvil. Its primary purpose is to provide clearance for punching tools, but it can also be used to hold tools that have round shanks. Pritchel tools are tools such as punches whose functions do not require them to be held at a particular orientation.

**English Shape, Traditional**

**Anvil Mini T Shape**



- Small and compact, hand hold it or place in mini vice (see codeV32981 for our full range) or drive it into a stump adapted to a hardy hole and bench block
- Made from cast iron

- Blackened coated finish
- Twin horned one side rounded, other shoulder squared and with planishing top face
- Traditional shape popular
- Size: 95 x 80 x 12mm
- Weight: 80 grams

Code	Description	UOM	Price
A34914	Anvil Mini T Shape	EACH	£2.95

**Bench Anvil**



- Made from cast iron
- Polished finish
- Traditional single flat wide horn with rounded shoulder
- Nice size planishing face 75mm x 42mm
- Size: 130 x 43 x 70mm
- Weight: 900 grams

Code	Description	UOM	Price
A34912	Bench Anvil	EACH	£5.95

**German Shape, Horn**

**Horn Anvi, Round Base**



- Made from cast iron
- Polished finish
- Twin horn anvil sits on a enamel finished base with two fixing screw holes giving sturdiness/non movement of anvil (screws not supplied)
- Having an anvil on a base gives a advantage of working with larger pieces your table top won't be in the way
- With a pritchel hole planishing top face, rounded and a shoulder horns
- Traditional shape popular for many years
- Size: 100 x 80 x 70mm
- Weight: 700 grams

Code	Description	UOM	Price
A4917	Horn Anvi, Round Base	EACH	£7.75

**Bench Peg & Forming Kit**



See Page 649

### Horn Anvil, Heavy Duty



- Made from cast iron
- Heavy Duty
- Polished finish
- Twin horn anvil sits on an enamel finished base with two fixing screw holes giving sturdiness/non movement of anvil (screws not supplied)
- Having an anvil on a base gives an advantage of working with larger pieces your table top wont be in the way
- With a pritchel hole planishing top face, rounded and a shoulder horns
- Traditional shape popular for many years
- Size: 190 x 115 x 40mm
- Weight: 3 kg

Code	Description	UOM	Price
A34913	Horn Anvil, Heavy Duty	EACH	£15.70

### USA Shape, Horn

#### Horn Anvil with Arch Base



- Made from cast iron
- Smooth shine finish
- With a pritchel hole planishing top face, rounded and a shoulder horns
- Traditional shape popular for many years
- Size: 110 x 55 x 25mm
- Weight: 450 grams

Code	Description	UOM	Price
A4916	Horn Anvil with Arch Base	EACH	£9.95

#### Horn Anvil with Flat Base



- Twin horn Anvil
- Made for precision work this miniature machined horned anvil is case hardened steel.
- High polished finish
- With a pritchel hole planishing top face, rounded and a shoulder horns
- A traditional model which has remained popular for many years.
- Size: 110 x 65 x 35mm
- Weight: 500 grams

Code	Description	UOM	Price
A0008	Horn Anvil with Flat Base	EACH	£8.65

## TUBE & WIRE BENDER

### Sheet & Wire Bender

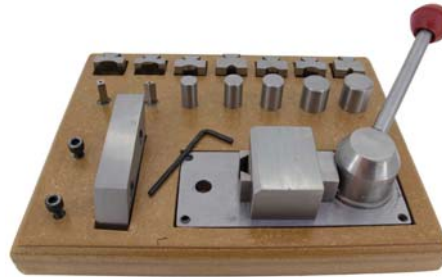

A high quality tool that allows you to bend and shape metal sheet or wire with total ease.

How to use:

- Simply remove the tool from the storage base
- Insert desired size & shape dies
- Use the spring loaded cam operated lever to bend your metal to desired shape
- Excellent for creating ring shanks

Features:

- 7 sets of dies (5 round, 1 square & 1 rhombus)
- Die sizes: Ø12, 14, 16, 20, 22mm, 90° & 60° & 30° (60° & 30° are the same die)
- Dies are hardened and polished steel
- Round, 90°, 60° & 30° angles all possible
- Tool can be screwed down to base, used loose or inserted in a bench vice using the extra base block provided
- Lever cam system ensures minimal effort is required
- All supplied on wooden bade
- Made in India

Dimensions:

- Die height: 17mm
- Bender: 140 x 60 x 40mm
- Wooden base: 240 x 200mm
- Weight: 5Kg

Code	Description	UOM	Price
R48608	Ring Shank & Metal Bender	EACH	£99.95

### Sheet & Wire Bender, Durston



A high quality tool, manufactured by Durston, that allows you to bend and shape metal sheet or wire with total ease.

How to use:

- Simply remove the tool from the storage base
- Insert desired size & shape dies
- Use the spring loaded cam operated lever to bend your metal to desired shape
- Excellent for creating ring shanks

Features:

- Superior quality, precision engineering
- Dies line up perfectly together
- 7 sets of dies (5 round, 1 square & 1 rhombus)
- Die sizes: Ø12, 14, 16, 20, 22mm, 90° & 60° & 30° (60° & 30° are the same die)
- Dies are hardened and polished steel
- Round, 90°, 60° & 30° angles all possible
- Tool can be screwed down to base, used loose or inserted in a bench vice using the extra base block provided

- Lever cam system ensures minimal effort is required
- All supplied compact storage & transportation case
- Delrin dies available for use with softer or patterned rings & metal
- Durston 1307
- Made in UK

Dimensions:

- 5Kg

Code	Description	UOM	Price
R45658	Ring Shank & Metal Bender, Durston	EACH	£173.95
R45659	Delrin Dies for Ring Shank & Metal Bender	PACK*5	£48.95

### Tube & Wire Bender



Irwin Hillman tools, Made in Germany

For bending wire and tube of smaller diameters; able to use on the following metals: gold, silver, platinum, palladium, brass, copper, stainless steel, aluminium and steel.

- Form bangles, hoops, earrings, necklace and chokers when designing and making
- Comprises three grooves to form three, four and six millimetre diameter sizes
- Made from steel and black in finish
- Designed for use with tubes up to diameter Ø6mm

How to use...

1. Push the top handle forwards completely; place the tube or wire into appropriate groove.
2. Ensure the wire length is sufficient enough to thread through the tool, so the bending action can be complete.
3. Press the handles down and the bottom groove lines meet so you are pushing down the tube or wire to form the bend.

- Size 140mm x 65mm x 25mm
- Weight: 150g

Code	Description	UOM	Price
P34121	Mini Tube & Wire Bender	EACH	£25.85

### Tube & Wire Bender, Tabletop



The wire bender lets you bend metals up to 2mm in diameter using several techniques.

- The tool is designed to either be clamped into your bench-top vice, or screwed directly to your bench. The two included screws firmly attach the jig to your work surface if you prefer not using a vice. Having the wire bender firmly mounted is key to it working properly.
- The aluminum base has several grooves and profiles in it, so you can easily bend right angles and semi circles.
- The wire bender also features four removable pins enabling you to configure custom bending patterns.

Size: 110 x 25 x 15mm

Weight: 85g

Code	Description	UOM	Price
W34927	Table Top Wire Bender	EACH	£1.65



Tube & Wire Shaping Tool

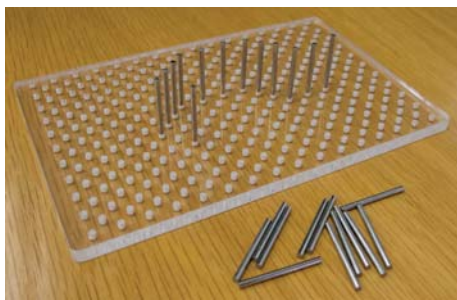

This multi pin wire bender lets you bend metals and wire using several techniques into any pattern/shapes you desire.

- Plastic rectangular base, 150 x 100mm
- 25 pins included
- 326 holes
- Can make intricate shapes as pins are multi positional

Code	Description	UOM	Price
W39058	Tube & Wire Shaping Tool	EACH	£6.95

Wire Shaping Mandrels



- Wire working mandrels
- Square, round & triangular mandrels & handle
- Mandrels are stepped allowing you to create multiple sizes
- Single interchangeable handle
- Plastic, lightweight and easy to use
- Colour may vary
- Set of 3
- Overall length 100mm (excluding handle)

Code	Description	UOM	Price
W45696	Wire Working Mandrel Set	PACK*3	£4.95

BLOCKS, CUBES, PUNCHES - DAPPING



Our variety of dapping blocks, cubes, punches & sets makes forming and doming sheet metal

into shapes adding dimensions and depth to designs simple. Made in various materials metal, brass, rubber and wood, we cater for all types of working material and practices.

These hardened and machined manufactured tools meet thorough quality standards for consistent quality results. Additionally we have a quality economic range which offers excellent quality products at low prices. The metal grades are of exceptional quality matched with a high-quality finish.

Cousins top tip: Punches should be stored in dry areas to avoid rusting and pitting, also use WD40 lubricant (code C32757) to maintain longevity.

Which punch and die combinations?

The thickness of the sheet determines the punch and dies size to be used to shape sheet metal. For thin gauge metals a punch and die with similar diameters works better together for a close fit.

For doming, cut the desired shape out of the sheet metal and anneal it. Using a dapping punch and die to firstly press the sheet into a large, shallow die, then into deeper dies, annealing as needed. As you work the entire surface, the metal will take on a curve. Don't try to complete the dome in one step unless you need a very shallow curvature. Practice on scrap metal to develop this practice.

Annealing:

The process of heating and cooling metal to make it softer/pliable so it will be easier to work with. The required temperature for annealing, the duration of heating and the rate of cooling vary according to the metal used. When you heat the metal ensure red cherry colour is achieved. Let the item naturally cool down rather than immersing the item in water immediately. Put on a metal planishing (P5202) block to help cool quicker. Wait for the red cherry colour to disappear then place in cold water. If the heated metal is submerged too quickly in water the piece may become distorted; however metal becomes hard when subjected to mechanical working. This effect is called 'work hardening'; as soon as the metal becomes difficult to move, re-anneal it. Annealing will not damage the metal, but trying to bend work-hardened metal may cause it to crack or buckle.

Here are some annealing temperatures and guidelines.

- Fine gold annealing not required
- 18ct yellow and red gold anneals at 650°C while white anneals at 750°C
- 14ct yellow and red gold anneals at 650°C while white anneals at 750°C
- 9ct gold anneals at 650°C
- Sterling Silver anneals between 600-650°C
- Platinum anneals between 900-1000°C
- Copper anneals at 650°C
- Brass anneals at between 600-650°C
- Nickel Silver (German silver) anneals at 650-680°C
- Aluminium anneals at 300-350°C

Dapping Blocks, Steel



- 27 Holes
- Range from Ø2.00mm to 25.00mm

- Made in India
- Dimensions:
- 130 x 65 x 25mm
- Weight 1.4Kg

Code	Description	UOM	Price
D34918	27 Hole, Dapping Block	EACH	£16.95

Dapping Blocks, Wooden



- Shaped wooden dapping block
- Flower, heart, hexagon, oval, round & tear drop
- 165 x 90 x 20mm
- Made from wood preventing scratches and marks to softer metals

Code	Description	UOM	Price
D41177	Flower Dapping Block	EACH	£6.15
D41173	Heart Dapping Block	EACH	£6.15
D41174	Hexagonal Dapping Block	EACH	£6.15
D41176	Oval Dapping Block	EACH	£6.15
D41175	Round Dapping Block	EACH	£6.50
D41172	Tear Drop Dapping Block	EACH	£6.15

Dapping Blocks, Wooden Extra Large



- 2 Extra large (XL) concave domes, Ø135mm
- 4 half round grooves: Ø15, 18, 20 & 25mm
- Made from wood preventing scratches and marks to softer metals
- Made in India
- Dimensions:
- 170 x 170 x 70mm
- Weight 1.15Kg

Code	Description	UOM	Price
D39417	Dapping Block, Wooden	EACH	£15.95

Dapping Cubes, Brass



- Dapping / Doming Cubes
- Brass

• Multi Diameter Holes

Code	Description	UOM	Price
D36261	30mm, 60 Domed Cube	EACH	£7.95
D36262	40mm, 64 Domed Cube	EACH	£8.95
D4240	50mm, 64 Domed Cube, UK	EACH	£35.95

**Dapping Cubes, Bronze**



Bronze is a harder material than brass, so can be used with stronger materials and will not need as much surface finishing when used

- Dapping / Domes Cube
- Bronze
- Multi Diameter Holes
- 50 or 60mm square
- Range Ø3mm to Ø35mm Domes
- C39416 has face with 15 ring punch indentations

Code	Description	UOM	Price
D36263	50mm, 56 Domed Cube	EACH	£19.95
C39416	60mm, 52 Domed Cube with Ring Punch Block	EACH	£22.95

**Dapping Cubes, Steel**



- D45555
  - 12 Domes
  - 25mm square
  - Range Ø3mm to 14mm
- D19982
  - 18 Domes
  - 50mm square
  - Range Ø4mm to Ø40mm
- D4239
  - 18 Domes
  - 50mm square
  - Range Ø4mm to Ø45mm
  - Made in UK
- D41192
  - 26 Domes
  - 70mm square
  - Range Ø3 to Ø52mm
  - Mirror polished domes
  - Made from high quality carbon steel (international grade 52100)
  - Carbon steel is harder than stainless steel, will last longer and is more robust
- D35074
  - 25 Domes
  - 100mm square
  - Range Ø4.5mm to Ø70mm

Code	Description	UOM	Price
D45555	25mm, 12 Domes, Ø3 to Ø14mm	EACH	£4.95
D19982	50mm, 18 Domes, Ø4mm to Ø40mm	EACH	£12.95
D4239	50mm, 18 Domes, Ø4mm to Ø45mm, UK	EACH	£62.05
D41192	70mm, 26 Domes, Ø3mm to Ø52mm, Carbon Steel	EACH	£99.95
D35074	100mm, 25 Domes, Ø4.5mm to Ø70mm	EACH	£33.95

**Dapping Cubes - Wooden**

- Cube 70mm
- 4 Domes Ø50, Ø54, Ø55, Ø60mm
- 2 V grooves: 6 x 10mm & 6 x 12mm
- 2 Rectangular grooves: 3.5 x 14mm & 3.5 x 11.5mm
- 5 Half round grooves, widths: 5, 7, 8, 9, 10 & 12mm
- Weight 220g
- Made from wood preventing scratches and marks to softer metals



Code	Description	UOM	Price
D31266	Wooden Forming / Dapping Cube	EACH	£11.95

**Dapping Disc - Steel, Rubber Mounted**



- An excellent set which includes 11 round dapping holes as well as 9 forming grooves on top of a thick vulcanised rubber firm base which absorbs the shock
- Allows you to hammer without creating excess noise or vibration at your bench

Hole diameters:  
 • Ø5.00, 6.00, 7.00, 7.50, 8.50, 10.00, 11.00, 11.50, 12.00, 13.00 & 19.50mm

Forming Grooves:  
 • 3 "V" shaped: 3 x 2mm, 2.5 x 2mm & 2 x 2mm  
 • 3 flat: 3.5, 3 & 2.5mm  
 • 3 half round: Ø4, 3.5 & 3mm

Dimensions are approx.

Code	Description	UOM	Price
D37128	Dapping Disc on Rubber Base	EACH	£14.95



**Final Finishing Polishing Compound**

See Page 1170



**Files**

See Page 859



**Dapping Punches, Delrin**



- 8 pieces
- Sizes: Ø6, 9, 12, 15, 18, 20, 24 & 28mm
- Weight 300g
- Inexpensive & lightweight

Code	Description	UOM	Price
D41191	Ø6mm to Ø28mm Punch Set	PACK*8	£10.95

**Dapping Punches, Steel**

**Ø2.30 to Ø13.00mm Punch Set of 12**



- High quality doming punch set of 12 on a wooden stand with tempered round anodised head
- Each punch is polished to a mirror finish to a high standard
- Sizes: Ø2.30, 3.50, 4.30, 5.10, 5.90, 6.70, 7.50, 8.30, 9.10, 9.90, 10.70 & 13.00mm
- Weight: 600g

Code	Description	UOM	Price
P36483	Ø2.30 to Ø13.00mm Punch Set of 12	PACK*12	£13.95

**Hammers**

See Page 906



**Ø2.80 to Ø25.30mm Punch Set of 24**



- High quality doming punch set of 24 on wooden stand, tempered round anodised heads
- Each punch head is polished to a mirror finish to a high standard
- Sizes: Ø2.80, 3.20, 3.60, 4.00, 5.60, 6.40, 7.20, 8.00, 9.50, 10.40, 11.20, 11.80, 12.60, 14.40, 15.00, 15.70, 17.60, 18.30, 19.00, 19.80, 20.70, 22.25, 23.90 & 25.30mm
- Weight 3.1Kg
- Made in India

Code	Description	UOM	Price
P20871	Ø2.80 to Ø25.30mm Punch Set of 24	PACK*24	£52.25

**Ø3.50 to Ø25.30mm Punch Set of 36**



- High quality doming punch set of 36 on a wooden stand with tempered round anodised head
- Each punch is polished to a mirror finish to a high standard
- Sizes: Ø3.50, 3.80, 4.40, 5.00, 5.40, 5.50, 6.70, 7.00, 7.30, 8.00, 8.50, 9.00, 9.50, 10.00, 10.50, 11.00, 11.50, 12.00, 12.50, 13.00, 13.50, 13.80, 14.30, 14.60, 16.0, 16.50, 17.20, 18.30, 18.80, 19.50, 20.50, 21.30, 22.20, 23.00, 24.30 & 25.30mm
- Weight: 2.9kg

Code	Description	UOM	Price
P36312	Ø3.50 to Ø25.30mm Punch Set of 36	PACK*36	£31.50

**Ø12.60 to Ø25.30mm Punch Set of 12**



- High quality doming punch steel set of 12 on wooden stand
- Each punch head is polished to a mirror finish to a high standard
- Sizes: Ø12.60, 14.40, 15.00, 15.70, 17.60, 18.30, 19.00, 19.80, 20.70, 22.25, 23.90 & 25.30mm
- Weight 2.5Kg
- Made in India

Code	Description	UOM	Price
P20870	Ø12.60 to Ø25.30mm Punch Set of 12	PACK*12	£25.95

**Dapping Punches, Steel, Repousse**



**Repousse Dapping Punches**

- Ideal for creating intricate detail on metal surfaces
- Stainless steel punches
- Set of 15 punches
- Supplied with wooden stand

**Shapes included:**

- Domed
- Round
- Triangle
- Square
- Straight
- Hollow

Code	Description	UOM	Price
P46144	Repousse Punches, Stainless Steel	PACK*15	£99.95

**Dapping Punches - Steel, Shaped**



- Shaped punch set
- Oval, tear drop, triangle, square, heart & star all included
- Approx. overall length of each punch 90mm
- Double ended, big and small pattern available
- Excellent for decorative designs on rings or patterns on work
- Supplied in plastic wallet
- Made in India

**Dimensions:**

- Rectangle: 19 x 14mm & 5 x 3mm
- Square: 16 x 16mm & 3.50 x 3.50mm
- Star: Widest point 20mm & 5mm
- Triangle: 20 x 20 x 20mm & 5 x 5 x 5mm
- Oval: 22 x 16mm & 5 x 4mm
- Tear drop: 23 x 17mm & 5 x 4mm
- Heart: 20 x 22mm & 4 x 5mm

All dimensions are approx.

Code	Description	UOM	Price
P38759	Shaped Punches, Steel	PACK*7	£15.95

**Dapping Punches, Italian**



**Doming Punches**

- Individuals by Size
- Hard polished heads
- O.M.O Italy

Code	Description	UOM	Price
D6551A	Ø2mm Punch	EACH	£5.95
D6551B	Ø3mm Punch	EACH	£5.95
D6551C	Ø4mm Punch	EACH	£5.95
D6551D	Ø5mm Punch	EACH	£5.95
D6551E	Ø6mm Punch	EACH	£5.95

**OVER 130,000 DIFFERENT ITEMS**

**Jewellers Tin-Snips Curved End Shears**

**VALUE**

**See Page 830**

**Online Discounts**

**SAME DAY DISPATCH**

**Knife Edge Cutter Burrs**

**See Page 809**

**Jewellery Drill Bits**

**See Page 837**

## Dapping Punches, UK



- Doming punch set
- Set of 15 or 3
- Hard polished heads
- See website "more info" for specification
- Made in UK

Code	Description	UOM	Price
D4243	Ø5.50 to 18.50mm Punches	PACK*15	£53.95
D5073	Ø25.5, 32 & 38mm Punches	PACK*3	£59.95

## Dapping Punches, Wooden



- 24 pieces
- Sizes Ø10mm to Ø25mm
- Weight 500g
- Made from wood preventing scratches and marks to softer metals
- Lightweight and easy to handle
- Inexpensive

Code	Description	UOM	Price
P20868	Ø10mm to Ø25mm Punch	PACK*24	£10.95

PRICE PROMISE  GUARANTEE

Riva Calico Mops

COUSINSUK

See Page 1121



## Dapping Punches, Wooden Extra Large



- 2 pieces
- Sizes Ø55mm to Ø70mm
- Overall height 1170mm
- Extra large (XL)
- Lightweight and easy to handle
- Inexpensive
- Made from wood preventing scratches and marks to softer metals

Code	Description	UOM	Price
D46138	Ø55 & Ø70mm Punches	PACK*2	£7.95

Dapping Sets, Wooden

## Block with 1 Punch (Multishape)



- Multishape dapping block
- 4 shapes: Teardrop, round, oval & heart
- Supplied with punch
- Block: 130 x 50 x 50mm

Code	Description	UOM	Price
D45777	Block with 1 Punch (Multishape)	EACH	£10.95

## Block with 6 Punches (Ø18 to 54mm)



- Quality rosewood
- Smooth finish
- 6 punches & 8 hole dapping block
- Sizes marked on base
- Punch sizes: Ø18, 18.5, 19, 22, 45 & 54mm
- Dapping block sizes: Ø32, 35, 38, 50, 65, 70, 75 & 80
- Dapping block size: 280 x 155 x 85mm

Code	Description	UOM	Price
D39424	Block with 6 Punches (Ø18 to 54mm)	EACH	£27.95

 IMPROVED  
SPEED SEARCH

## Block with 10 Punches (Ø16 to 65mm)



- Quality hardwood
- Smooth finish
- 10 punches & 10 hole dapping block
- Punch sizes: Ø16 to Ø65mm
- Dapping block size: 180 x 100 x 50mm

Code	Description	UOM	Price
D45783	Block with 10 Punches (Ø16 to 65mm)	EACH	£27.95

## Cube with 2 Punches (Ø13 &amp; 21mm)



- 2 punches, Ø13 & 21mm
- Dapping cube, 60 x 60mm
- 6 domes, from Ø23 to 45mm

Code	Description	UOM	Price
D39418	Cube with 2 Punches (Ø13 & 21mm)	EACH	£3.95

## Cube with 7 Punches (Ø25 to 65mm)



- Quality hard wood
- Smooth finish

## FORMING TOOLS

- 7 punches with dapping block
- Punch sizes: Ø25, 32, 37, 40, 45, 51 & 64mm
- Dapping block size: 75 x 75mm
- Supplied with woden stand

Code	Description	UOM	Price
D45782	Cube with 7 Punches (Ø25 to 65mm)	EACH	£29.95

### Dapping Sets

#### Block with 3 Punches (Ø40 to Ø50mm)



- King size dapping set
- 3 punches, Ø40, 45 & 50mm
- With equivalent dapping block
- Supplied with wooden stand

Code	Description	UOM	Price
D41193	Block with 3 Punches (Ø40 to Ø50mm)	EACH	£51.95

#### Cube with 6 Punches (Ø30 to Ø65mm)



- King size dapping set
- 6 punches, Ø30, 38, 45, 50, 57 & 65mm
- With equivalent dapping cube
- Supplied with wooden stand

Code	Description	UOM	Price
D41186	Cube with 6 Punches (Ø30 to Ø65mm)	EACH	£79.95



**BROWSE & BUY**

Sievert Torch Kit for Jewellers

See Page 651



#### Cube with 24 Punches (Ø2.30 to Ø25mm)



- Comprehensive dapping set
- 24 punches, from Ø2.30 to 25mm
- With doming block
- Stylish black finish
- Stainless steel
- Supplied with plastic stand

Code	Description	UOM	Price
D45781	Cube with 24 Punches (Ø2.30 to Ø25mm)	EACH	£33.50

### Dapping Sets, Durston

#### 21 Punches and Dapping Cube, Durston



The Durston small dapping set is a prime example of a well-engineered jewellers tool.

- Extreme high quality hardened steel construction and highly mirror polished finished
- 21 punches with a 21 punch dapping block
- Complete with a carrying/storage stand
- Weight: 6kg
- Durston 1102
- Made in UK

Diameter sizes of punches and dapping domes: Ø3, 4, 5, 6, 7, 8, 9, 10, 11, 12, 13, 14, 15, 17, 19, 21, 23, 25, 28, 32, 36mm

Dapping cube size: 50 x 50mm

Code	Description	UOM	Price
D35088	21 Punches and Dapping Cube, Durston	PACK*21	£175.00

**PRICE PROMISE GUARANTEE**



WD-40 Lubricating Aerosols

See Page 1180



#### 24 Punches and Dapping Cube, Durston



The Durston large dapping set is a prime example of a well-engineered jewellers tool.

- Extreme high quality hardened steel construction and highly mirror polished finished
- 24 punches with a 24 punch dapping block
- Complete with a carrying/storage stand
- Weight: 8kg
- Durston 1101
- Made in UK

Diameter sizes of punches and dapping domes: Ø3, 4, 5, 6, 7, 8, 9, 10, 11, 12, 13, 14, 15, 17, 19, 21, 23, 25, 28, 32, 36, 40, 45, 50mm

Dapping cube size: 70 x 70mm

Code	Description	UOM	Price
D35089	24 Punches and Dapping Cube, Durston	PACK*24	£188.95

### Dapping Sets, Italian

#### 31 Punches and Dapping Base, Italian



Doming Punch Set and Base On Stand

- Set of 31 punches 2 to 32mm
- Base on stand
- Hard polished head

Made in Italy

Code	Description	UOM	Price
D6551	31 Punches and Dapping Base, Italian	PACK*31	£350.00

**+ Contact & Services**

**Your direct line to our Management Team**

### Wooden Base for Forming Tools, Italian

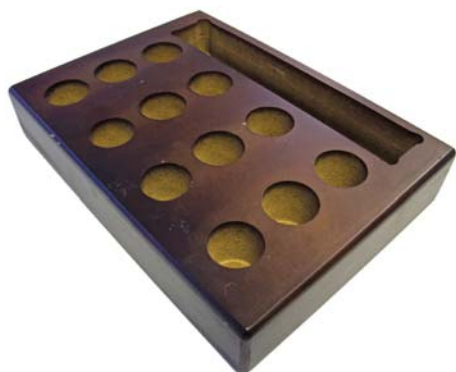

- Overall size: 22 x 16 x 4cm
- 12 Holes: Ø26mm x 30mm deep
- 1 large slot 18mm x 30mm x 30mm
- Polished/sealed wood

Made in Italy

Code	Description	UOM	Price
D8339	Wooden Base for Forming Tools, Italian	EACH	£35.95

### Dapping & Swage Set, Italian



37 piece combination outfit on polished wood base / holder.

Comprises:

- Full Dapping Set with 31 punches from Ø2 to 32mm
- Horn anvil on 100mm stand.
- Collet block with round stake.
- Grooving / Swage blocks etc.
- O.M.O Italy

Code	Description	UOM	Price
D8338	Dapping & Forming "Deluxe" Complete Set, Italian	PACK*37	£575.00

### Dapping & Swage Set, 40 Piece



Comprehensive dapping set with Swage block and cube included

- Best grade steel/iron used with smartly polished finish
- Comes with wooden compartment stand with sizes markings
- 36 Punches

- Doming Block
- Doming Cube
- Swage Block
- Swage Cube

Specifications:

- Steel doming block: 60mm square, range Ø4 to Ø45mm
- 36 piece set of doming punches, sizes: Ø3.5, 4, 4.5, 5, 5.5, 6, 6.5, 7, 8, 8.5, 9, 9.5, 10, 10.5, 11, 11.5, 12, 12.5, 13, 13.5, 14, 14.7, 15.4, 16.2, 17, 17.8, 18.6, 19.4, 20.2, 21, 21.8, 22.6, 23.4, 24.2 & 25mm
- Multi size swage block, 10 grooves: Ø5, 6, 8, 10, 11, 13, 14, 16, 18, 19mm. Length of grooves 40mm
- Multi shaped forming cube:
  - 8 half round grooves
  - 5 rectangle/right angle grooves
  - 7 'V' Grooves
- Wooden storage base size 270 x 230 x 35mm
- Made in India
- Weight: 11kg

Code	Description	UOM	Price
F39423	36 Punches & Dapping Block & Cube, with Swage Block & Cube	EACH	£94.95

### Dapping & Swage Set, 55 Piece



We would proudly like to present this fantastic forming kit made with quality and preciseness in mind.

Comprehensive dapping set with swage block, cube, swage bars & anvil included

- Best grade steel/iron used with smartly polished finish
- Comes with wooden compartment stand with sizes markings
- 36 Punches
- Doming Block
- Doming Cube
- Forming/Swage Cube
- 15 Forming Bars
- Twin Horn Anvil

Specifications:

- Twin horn German shape anvil on base: 100 x 80 x 70mm
- Steel doming block: 60mm square, range Ø4 to Ø45mm
- 36 piece set of doming punches, sizes: Ø3.5, 4, 4.5, 5, 5.5, 6, 6.5, 7, 7.5, 8, 8.5, 9, 9.5, 10, 10.5, 11, 11.5, 12, 12.5, 13, 13.5, 14, 14.7, 15.4, 16.2, 17, 17.8, 18.6, 19.4, 20.2, 21, 21.8, 22.6, 23.4, 24.2 & 25mm
- Multi size swage block, 10 grooves: Ø5, 6, 8, 10, 11, 13, 14, 16, 18, 19mm. Length of grooves 40mm
- Multi shaped forming/swage cube:
  - 8 half round grooves: 30, 24, 20, 16, 9, 8, 5, 4mm
  - 4 rectangle/right angle grooves: 10 x 4, 8 x 3.5, 5 x 2.5, 4 x 1.5mm
  - 7 'V' Grooves: 10 x 4.55, 7.5 x 3.5, 5 x 2.5, 2 x 1.5, 7.5 x 6.5, 5.5 x 4, 2.5 x 2.5mm
- Set of forming bars:
  - 10 round: Ø24, 21, 18, 15, 11, 10, 7, 5, 3 & 2mm
  - 4 square: 6 x 6, 5 x 5, 4 x 4 & 3 x 3
  - 1 diamond: 45° angle, 16 x 11mm
- 1 x wooden storage base size 295 x 240 x 35mm
- Made in India
- Weight: 11.5kg

Code	Description	UOM	Price
F36084	Dapping & Swage Complete Set, Indian	PACK*55	£154.95

### BLOCKS, CUBES - SWAGE



The Swage block, swedge or swage anvil has been used for centuries. It is considered an indispensable tool by jewellers/silversmiths.

- Operations performed on a swage block are not limited to bending, punching and forming
- Create manufacture many styles shapes to your or customers specific designs like bezels for settings bangles earrings necklaces, ring parts, the sky's the limit with a swage block
- Shapes for examples on our swage blocks are half round, oval, rectangle, and v groove
- Simply cut your metals gold, silver, platinum, copper brass etc. And place a appropriate metal bar that fits in to you groove. Not all swage blocks come with metal bars but this is not a problem. You can pick up these from your local metal stockist or use some already purchased tools to perform the task
- Use the sides of your dapping punches for half round shape swage block or use your triblet/ring bezel triblet available in many shapes

### Half Round (Shapes Ø3.5 to Ø9mm)



- Best seller precision half round swage block made from best grade steel
- 6 Sizes: 3.5 to 9mm
- Ideal for forming tube, and collets
- Made in UK or unbranded

Dimensions:

- 105 x 38 x 12.5mm
- 360g

Code	Description	UOM	Price
S45568	Ø3.50 to Ø9.00mm Forming Block	EACH	£16.95
S4238	Ø3.50 to Ø9.00mm Forming Block, Made in UK	EACH	£29.95

### Half Round (Shapes Ø16 to Ø63.5mm)



- A traditional precision semi-circle swage block made from best grade steel
- Ideal for forming bangles and bracelets

# FORMING TOOLS

- 10 Half Round Groove: 16, 17.5, 23, 26, 30, 32, 46, 63.5mm
- Ideal for forming bangles and bracelet
- Made in UK

DimensionsL  
 • Overall size: 135 x 45 x 40mm  
 • Weight: 1.3 kg

Code	Description	UOM	Price
S4236	Ø16 to 63.5mm Half Round Forming Block	EACH	£69.75

## Half Round (Shapes Ø17.5 to Ø50mm) O.M.O. Italy



- O.M.O. Italy
- An old-fashioned precision semi-circle swage block made from best grade steel
  - Ideal for forming bangles and bracelet
  - 5 Half Round Grooves: 17.5, 22.5, 27.5, 40 and 50mm
  - High quality
  - Stainless steel

Dimensions:  
 • Overall size: 160 x 60 x 60mm  
 • Weight: 2.7 kg

Code	Description	UOM	Price
S5205	Ø17.50 to 50mm Half Round Forming Block	EACH	£65.95

## Half Round (Shapes Ø35 to Ø75mm)



- An old-fashioned precision semi-circle swage block made from best grade steel
- Ideal for forming bangles and bracelets
- Extra large grooves
- 3 Half Round Grooves: 35, 45 & 55mm
- 2 shallow half round grooves: Ø65 & 75mm
- Supplied with stepped madre, steps Ø25, 38 & 45mm
- Polished stainless steel
- High quality

Dimensions  
 • Overall block size: 160 x 55 x 55  
 • Weight: 3.6kg

Code	Description	UOM	Price
D45778	Ø35 to 75mm Half Round Forming Block	EACH	£79.95

## Multi Shaped Block

- Very popular multipurpose swage/dapping blocks
- One of its best features these forming blocks have are the selection of oval formers on one side not forgetting every side has 1/2 round, "V" grooves and dipped round sections
- We have two sorts available the Indian one is exceptional value good quality steel construction and finished to a satisfactory level
- The Italian is of an extreme precision

- machined, top grade selection of steel construction and of a high finish
- See website "more info" for further specification

## Multi Shaped Forming Block



- 8 Half round grooves, sizes: 25, 22, 16, 19, 12, 7, 5, 4mm
- 14 domes, sizes: Ø24, 20, 19, 18, 17, 15, 13, 11, 8, 7, 6, 5, 4, 3mm

Code	Description	UOM	Price
D34917	Multi Shaped Forming Block	EACH	£14.95

## Multi Shaped Forming Block



- 18 Half Round Grooves: 22, 21, 19, 18, 17, 15, 14, 13, 12, 11, 10, 9, 8, 7, 6, 5, 4, 3mm
  - 3 V grooves: 5 x 2.5, 3 x 2, 2 x 2mm
  - 17 Domes: Ø18, 17, 16, 15, 14, 13, 12, 11, 10, 9, 8, 7, 6, 5, 4, 3, 2mm
  - 5 Ovals: 22 x 15, 20 x 14, 20 x 13, 17 x 11, 16 x 11mm
- Overall size: 200 x 40 x 40mm  
 Weight: 2.1kg

Code	Description	UOM	Price
D31904	Multi Shaped Forming Block	EACH	£24.95

## Multi Shaped Forming Block, O.M.O. Italy



- O.M.O. Italy
- 19 Half Rounds: 25, 22, 19, 18, 15, 14, 13, 12, 11, 10, 9, 8, 7, 6, 5, 4, 3, 2, 1mm
  - 3 V grooves: 3 x 2, 3 x 1.50, 2 x 1mm
  - 15 Domes: Ø19, 17, 16, 14, 12, 10, 9, 8, 7, 6, 5, 4, 3, 2, 1mm
  - 6 Ovals: 28 x 21, 23 x 17, 18 x 14, 17 x 13, 13 x 11, and 12 x 10mm
  - High quality
- Overall size: 210 x 45 x 45mm  
 Weight: 2.9kg

Code	Description	UOM	Price
S8344	Multi Shaped Forming Block, O.M.O. Italy	EACH	£149.95



SAME DAY DISPATCH

## Multi Shaped Cube

- Vintage cube multi shaped forming blocks
- We have two sorts available, the Indian one is exceptional value good quality steel construction and finished to a satisfactory level
- The Italian is of an extreme precision machined, top grade selection of steel construction and of a high finish
- Cubes consist of half rounds, "V" grooves & rectangular/right angle channels
- See website "more info" for further specification

## Multi Shaped Forming Cube



- Cube Swage Block
- Medium varied sizes on a cube form
- 8 half round grooves: 30, 24, 20, 16, 9, 8, 5, 4mm
- 4 rectangle/right angle grooves: 10 x 4, 8 x 3.5, 5 x 2.5, 4 x 1.5mm
- 7 'V' Grooves: 10 x 4.55, 7.5 x 3.5, 5 x 2.5, 2 x 1.5, 7.5 x 6.5, 5.5 x 4, 2.5 x 2.5mm

Dimensions:  
 • Overall size: 60 x 60 x 50mm  
 • Weight: 1.2kg

Code	Description	UOM	Price
C34919	Multi Shaped Forming Cube	EACH	£16.95

## Multi Shaped Forming Cube Including Domes



- Cube Swage Block
- Medium varied sizes on a cube form
- 12 Domes: From Ø4 to Ø24mm
- 5 half round grooves: Ø3 to 6mm
- 6 'V' Grooves: Ø3 to 6mm
- 6 Flats: Ø3 to 6mm

Dimensions:  
 • Overall size: 50 x 50 x 50mm  
 • Weight: 900g

Code	Description	UOM	Price
D45776	Multi Shaped Forming Cube Including Domes	EACH	£15.50

## Multi Shaped Forming Cube, O.M.O. Italy



- O.M.O. Italy
- Medium varied sizes on a cube form
  - 8 Half Round: 30, 24, 20, 16, 9, 8, 5, 4mm
  - 5 Rectangle/Right Angle: 10 x 4, 8 x 3.5, 5 x 2.5, 4 x 1.5mm
  - 7 "V" Grooves: 10 x 4.55, 7.5 x 3.5, 5 x 2.5, 2.00 x 1.50, 7.50 x 6.50, 5.50 x 4, 2.50 x 2.50mm

• High quality

Dimensions:  
 • Overall Size 60 x 60mm  
 • Weight: 1.3kg

Code	Description	UOM	Price
S8352	Multi Shaped Forming Cube, O.M.O. Italy	EACH	£82.95

**Multi Shaped Kit**



**Cube & Forming Bars**

An excellent value forming set machined finished to a high standard.

- Best grade steel construction
- Includes a wooden storage stand marked with all the sizes
- Set comprises of perfectly shaped bars which fit precisely into the swage cube

Set includes:

**Block:**

- 8 half round: Ø30, 24, 20, 16, 9, 8, 5 & 4mm
- 5 rectangle/right angle: 10 x 4, 8 x 3.5, 5 x 2.5 & 4 x 1.5mm
- 7 "V" grooves: 10 x 4.55, 7.50 x 3.50, 5.00 x 2.50, 2.00 x 1.50, 7.50 x 6.50, 5.50 x 4.00 & 2.50 x 2.50mm
- Overall size: 60 x 60mm
- Weight: 1.3kg

**Forming Bars:**

- 10 round: Ø24, 21, 18, 15, 11, 10, 7, 5, 3 & 2mm
- 5 square: 6 x 6, 5 x 5, 4 x 4, 3 x 3 & 2 x 2
- Diamond: 45° angle, 6 x 11mm

Code	Description	UOM	Price
F36083	Multi Shape Professional Forming Set	PACK*17	£60.95

**Multi Shaped Kit, O.M.O. Italy**

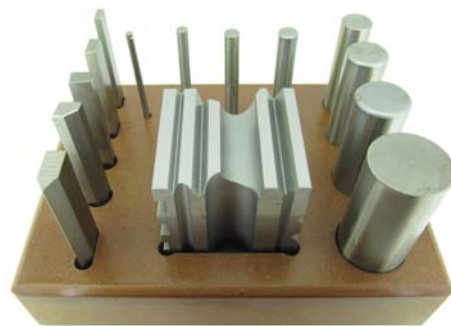

**O.M.O. Italy - Cube & Forming Bars**

This is an exceptional set made for the expert professional Jeweller, silversmith and jewellery artist

- Machined with accuracy and high grade steel construction
- Set comprising of perfectly shaped bars fitting into the cube former perfectly
- Wooden storage stand included

Includes wooden base 19x14cm

- High quality

**Cube:**

- 8 Half Round: 30, 24, 20, 16, 9, 8, 5, 4mm
- 5 Rectangle/Right Angle: 10 x 4mm, 8 x 3.5mm, 5 x 2.5mm, 4mm x 1.5mm
- 7 "V" Grooves: 10 x 4.55mm, 7.5 x 3.5mm, 5 x 2.5mm, 2.00 x 1.50mm, 7.50 x 6.50mm, 5.50 x 4mm, 2.50 x 2.50mm

**Bars:**

- 8 Round: Ø32, 23, 20, 16, 10, 8, 6 & 4mm
- 3 Rectangle: 9.5 x 7.5, 11.5 x 6 & 9.5 x 3.5 mm
- Diamond 45°c angle, 10.5 x 13.5mm

- Chisel 60°, 20 x 7.5mm

Code	Description	UOM	Price
S8337	Multi Shaped Professional Forming Set	PACK*14	£195.00

**Multi Shaped Kit, Wooden**



**Cube & Forming Bars**

An excellent value forming set made from wood

- Smooth wood finish
- Includes a wooden storage stand marked with all the sizes
- Set comprises of perfectly shaped bars which fit precisely into the swage cube
- Great value, perfect for the starting jewellers, or those working with softer metals such as gold

Set includes:

**Block:**

- 8 half round: Ø25, 22, 19, 17, 12, 11, 8 & 5mm
- 5 rectangle/right angle: 7.5 x 4.5, 7 x 4.5, 5.5 x 4.0, 5 x 4 & 4.5 x 3.5mm
- 5 "V" grooves: 13, 11, 9 & 7mm
- Overall size: 65 x 65mm
- Weight: 1.3kg

**Forming Bars:**

- 9 round: Ø25, 21, 18, 15, 11, 10, 7 & 5mm
- 5 rectangle: 12 x 7, 12 x 6, 12 x 5, 12 x 4 & 12 x 3mm
- Diamond: 45° angle: 14 x 14mm

Code	Description	UOM	Price
F39422	Multi Shaped Professional Forming Set	EACH	£18.95

**BLOCKS, PRESSES - PLANISHING**

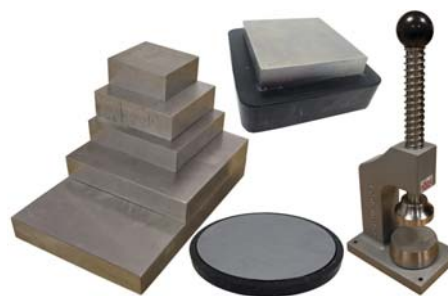

Planishing blocks are a thick metal slab made from the highest quality hardened steel to planish or 'hammer' on metals such as gold, silver, copper, brass, platinum, palladium, titanium, etc, in order to flatten metal after it has been cut with shears and/or put through a rolling mill. These processes, particularly the latter, can often make the surface uneven. Both sides of our planishing block are case hardened and ground flat polished on both sides, so the whole block is usable.

Additionally they are used to emboss patterns

on designs, simply place the pattern, for example wire/symbol etc, on the planishing block, then place the metal sheet over the pattern and planish until the model is transferred onto the sheet.

We have a large range of sizes to cater for big to small jobs as well as a vast array of hammers and mallets to use with our planishing blocks.

Please note:

To keep the Planishing Block maintained grease with WD40 (see link below) when not in use store in a dry place.

**Rubber, Noise Reduction**



**Rubber Planishing Blocks**

- Will not leave scratches when dapping with steel or wood
- Excellent for noise reduction
- Will reduce hand strain via a reduced vibration
- Multiple sizes available
- Width x length x height

Hint and Tip: Buy two and sandwich your piece between the two blocks; hammer to achieve a perfect and flattened finish, with no marks

Code	Description	UOM	Price
P38762	50 x 50 x 25mm Rubber Block	EACH	£2.95
D31265	100 x 100 x 25mm Rubber Block	EACH	£3.95
P39045	150 x 100 x 25mm Rubber Block	EACH	£4.50

**Urethane Pad**



- Urethane Pad
- Excellent for use with disc cutters, dapping and forming tools
- Noise reduction
- Bench protection
- 150 x 150 x 3mm

Code	Description	UOM	Price
D45779	150 x 150mm Urethane Pad	EACH	£12.95





## Steel (High Mirror Finish)

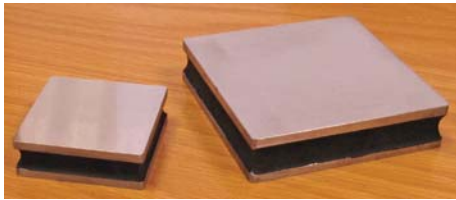

- Superior high mirror finish
- Fantastic for more delicate work
- Both sides have same high mirror finish
- Made in far east

Code	Description	UOM	Price
D35517	60 x 60 x 20mm Planishing Block	EACH	£8.95
D35518	100 x 100 x 25mm Planishing Block	EACH	£15.40

## Steel (Polished)



Standard planishing blocks from India available in various sizes

- Excellent value and price
- Best quality steel used, grounded down to a superb flat polished finish

Code	Description	UOM	Price
P34916	48 x 48 x 18mm, Planishing Block	EACH	£3.95
P34917	63 x 63 x 18mm Planishing Block	EACH	£4.80
P34918	74 x 74 x 18mm Planishing Block	EACH	£5.30
P34919	100 x 100 x 18mm Planishing Block	EACH	£8.95
P34920	150 x 100 x 18mm Planishing Block	EACH	£14.95
P34921	150 x 150 x 18mm Planishing Block	EACH	£18.95

## Steel (Polished), Durston

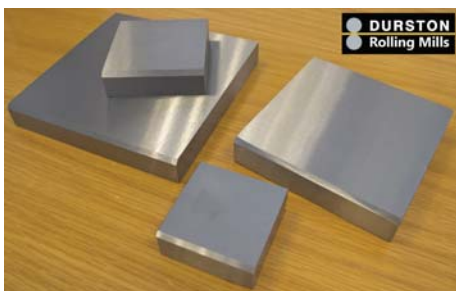

- Hardened tool steel
- Each block is ground flat, polished & case hardened
- High Quality
- Durston
- Made in UK

Code	Description	UOM	Price
P45648	50 x 50 x 20mm Planishing Block	EACH	£12.50
P45649	65 x 65 x 25mm Planishing Block	EACH	£14.95
P45650	100 x 100 x 20mm Planishing Block	EACH	£16.95
P45651	130 x 130 x 20mm Planishing Block	EACH	£28.95

## Steel (Polished), O.M.O Italy



- Hardened steel blocks with one rounded edge for forming curves
- Italian Manufacture
- High Quality
- O.M.O Italy

Code	Description	UOM	Price
P5201	50 x 50 x 20mm Planishing Block	EACH	£12.95
P5202	60 x 60 x 20mm Planishing Block	EACH	£15.50
P5203	80 x 80 x 20mm Planishing Block	EACH	£18.50
P5204	100 x 100 x 20mm Planishing Block	EACH	£22.95

## Steel (Polished with Round Edges), Wheatsheaf



- Hardened steel blocks with rounded edge for forming curves
- Polished surface
- High Quality
- Wheatsheaf
- UK Made

Code	Description	UOM	Price
P4244	76 x 76 x 20mm Planishing Block	EACH	£29.95
P4245	152 x 76 x 20mm Planishing Block	EACH	£44.95

## Steel (Polished with Rubber Mount), Round



- Another excellent set which includes a vulcanised rubber firm base which absorbs the shock plus a thinner solid steel block, which is 6mm thick
- Allows you to hammer without creating excess noise or vibration at your bench

Dimensions:

- Steel block: Ø120mm x 6mm
- Overall: Ø140mm x 10mm
- Weight: 700g

Code	Description	UOM	Price
A39042	Planishing Block with Rubber Base	EACH	£14.95

## Steel (Polished with Rubber Mount), Square



- An excellent set which includes a thick vulcanised rubber firm base which absorbs the shock plus a solid steel block which is 18mm thick
- Allows you to hammer without creating excess noise or vibration at your bench

Dimensions:

- Steel block: 70 x 70 x 18mm
- Overall: 100 x 100 x 35mm
- Weight: 1.1Kg

Code	Description	UOM	Price
P36317	Planishing Block with Rubber Base	EACH	£10.95

## Steel & Nylon (with Rubber Mount)



- This is an excellent set which includes a thick vulcanised rubber firm base which absorbs shock plus a solid steel block which is 18mm thick and 75mm diameter.
- The third piece is a sturdy nylon block the same size which fits into the rubber base for lighter more delicate work
- This is a well-made set, and allows one to hammer without creating excess noise vibration at the bench.

Weight: 1kg

Dimensions are approx.

Code	Description	UOM	Price
A34915	Ø75mm Dual Planishing Block	EACH	£9.95

## Planishing Presses



Planishing Presses

- Durston, O.M.O Italy or Indian
- Dimension given is the size of the press
- Spring loaded for ease of use
- Cast iron bodies.
- Hardened and polished press heads
- Can be bolted to the table or stability (bolts not supplied)



Planishing presses are in essence a planishing block and a heavy duty hammer comprised of the highest quality hardened steel to planish or 'hammer on metals such as gold, silver, copper, brass, platinum, palladium, titanium, etc. in order to flatten metal after it has been cut with shears and/or put through a rolling mill. Cutting and milling, can often make the surface uneven so a planishing press is a quick and efficient way of flattening your work after it has been formed.

Presses are great to emboss patterns or designs, simply place the pattern, for example wire/symbol etc, on the planishing pad, then place the metal sheet over the pattern and use the sprung planishing head to hammer the sheet until the model is transferred.

Please note:

- To keep the planishing surfaces maintained grease with WD40 (see link below).
- Bolt the press to a work surface through the pre-made holes in its base, approximately Ø10mm (bolts not supplied), preferably three to four inches long.

Overall dimensions (H x W x D);

- P6541: 400 x 130 x 190mm (13kg)
- P6540: 540 x 130 x 210mm (20kg)
- P47149: 540 x 140 x 220mm (22kg)
- P34924: 580 x 100 x 190mm (10kg)
- P35096: 600 x 100 x 20mm (16kg)

Code	Description	UOM	Price
P6541	Ø60mm Press, O.M.O Italy	EACH	£145.00
P6540	Ø78mm Press, O.M.O Italy	EACH	£175.00
P47149	Ø78mm Press, Durston	EACH	£188.95
P34924	Ø100mm Press, India	EACH	£69.95
P35096	Ø100mm Press, Heavy Base, India	EACH	£79.95

## COLLET BLOCKS AND PLATES



Collets are metal bands/claws which surround a gemstone and collet making is an important and essential skill in the art of stone setting

The art of collet making has been used for generations with jewellery makers all over the world. Modern times though have changed the way jewellers use collets/mounts as when designing a handmade piece they can buy readymade mounts. This can prove to be costly and you will not always find the styles/sizes your customer requires or prefers. Using readymade mounts also takes away that defining element of handmade jewellery which your customers will appreciate more and are willing to pay for. There is nothing like fashioning and making collet mounts specific to your designs giving further elegance to your jewellery range.

We have a wide selection available with different shapes, sizes and angles, all made from highest quality steel. Looked after properly, they could well last a life time and may even be passed from one generation to the next.

Quick guide to making a collet:

1. Measure your gemstone and work out its outer size all round circumference/perimeter.
2. Cut a straight strip of metal; gold, silver, platinum, palladium, copper, brass etc.
3. Depending on the shape of your gemstone, form your strip around a mandrel; round,

square, oval, triangle, rectangle, oval etc. (Ref M20873A)

4. Solder the joining seam.

5. You will notice our great range of collet blocks/plates available in various shapes, sizes and angles. This allows you to choose one that will suit your design ambitions.

6. Form your shape in to your collet block and plate, this process is also known as coning.

7. You can then saw, file or burr your collet to your obtain one of many possible effects and styles

Shapes:

- Oval - 4 to 14mm
- Rectangle - 5 to 15mm
- Round - 5 to 20mm
- Square - 4 to 14mm
- Tear Drop - 4 to 14mm

### Half Round (O.M.O Italy)

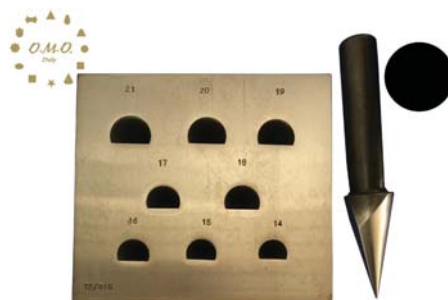

- Collet block with half round holes
- Various sizes
- 17 degree angled punch
- Overall size 100 x 90 x 25mm
- Hardened steel
- "Special K" tool steel
- O.M.O Italy

Dimensions:

- Collet sizes x degree of punch

Code	Description	UOM	Price
C48145	Ø5 to Ø15mm with 17 Degree Punch	EACH	£179.95
C48146	Ø14 to Ø21mm with 17 Degree Punch	EACH	£233.50

### Heart (O.M.O Italy)



- Collet block with heart shape holes
- Various sizes
- 17 degree angled punch
- Overall size 100 x 90 x 25mm
- Hardened steel
- "Special K" tool steel
- O.M.O Italy

Dimensions:

- Collet sizes x degree of punch

Code	Description	UOM	Price
C48161	5 to 15mm with 17 Degree Punch	EACH	£199.95
C48162	14 to 21mm with 17 Degree Punch	EACH	£259.00

PRICE PROMISE GUARANTEE

### Hexagonal (O.M.O Italy)



- Collet block with hexagonal holes
- Various sizes
- 17 degree angled punch
- Overall size 100 x 90 x 25mm
- Hardened steel
- "Special K" tool steel
- O.M.O Italy

Dimensions:

- Collet sizes x degree of punch

Code	Description	UOM	Price
C48106	4 to 14mm with 17 Degree Punch	EACH	£62.95
C48107	14 to 21mm with 17 Degree Punch	EACH	£120.20

### Hexagonal (O.M.O Italy) Elongated



- Collet block with elongated hexagonal holes
- Various sizes
- 17 degree angled punch
- Overall size 100 x 90 x 25mm
- Hardened steel
- "Special K" tool steel
- O.M.O Italy

Dimensions:

- Collet sizes x degree of punch

Code	Description	UOM	Price
C48108	4 to 14mm with 17 Degree Punch	EACH	£74.95
C48109	14 to 21mm with 17 Degree Punch	EACH	£120.20

### Hexagonal (O.M.O Italy) Extra Elongated



- Collet block with extra elongated hexagonal holes
- Various sizes
- 17 degree angled punch
- Overall size 100 x 90 x 25mm
- Hardened steel
- "Special K" tool steel
- O.M.O Italy

Dimensions:

- Collet sizes x degree of punch

Code	Description	UOM	Price
C48110	4 to 14mm with 17 Degree Punch	EACH	£74.95
C48111	14 to 21mm with 17 Degree Punch	EACH	£120.20

## Octagonal (O.M.O Italy)



- Collet block with Octagonal holes
- Various sizes
- 17 degree angled punch
- Overall size 100 x 90 x 25mm
- Hardened steel
- "Special K" tool steel
- O.M.O Italy

Dimensions:

- Collet sizes x degree of punch

Code	Description	UOM	Price
C48119	4 to 14mm with 17 Degree Punch	EACH	£64.95
C48120	14 to 21mm with 17 Degree Punch	EACH	£120.20

## Oval (O.M.O Italy)



- Collet block with oval holes
- Various sizes
- Various degree punches available
- Overall size 100 x 90 x 25mm
- Hardened steel
- "Special K" tool steel
- O.M.O Italy

Dimensions:

- Collet sizes x degree of punch

Code	Description	UOM	Price
C6537	4 to 14mm with 17 Degree Punch	EACH	£84.95
C48101	14 to 21mm with 17 Degree Punch	EACH	£119.95

**PRICE PROMISE  
GUARANTEE** 

Planishing,  
Stretching &  
Bumping Hammer



See Page 910

## Oval (O.M.O Italy) Perfect

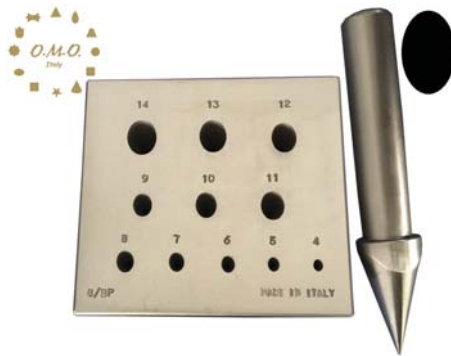

- Collet block with perfect oval holes
- Various sizes
- 17 degree angled punch
- Overall size 100 x 90 x 25mm
- Hardened steel
- "Special K" tool steel
- O.M.O Italy

Dimensions:

- Collet sizes x degree of punch

Code	Description	UOM	Price
C48147	4 to 14mm with 17 Degree Punch	EACH	£179.95
C48148	14 to 21mm with 17 Degree Punch	EACH	£233.50

## Oval (O.M.O Italy) Narrow



- Collet block with narrow oval holes
- Various sizes
- 17 degree angled punch
- Overall size 100 x 90 x 25mm
- Hardened steel
- "Special K" tool steel
- O.M.O Italy

Dimensions:

- Collet sizes x degree of punch

Code	Description	UOM	Price
C6531	4 to 14mm with 17 Degree Punch	EACH	£89.95
C48102	14 to 21mm with 17 Degree Punch	EACH	£120.20

## Oval (O.M.O Italy) Narrow Perfect



- Collet block with perfect narrow oval holes
- Various sizes
- 17 degree angled punch

- Overall size 100 x 90 x 25mm
- Hardened steel
- "Special K" tool steel
- O.M.O Italy

Dimensions:

- Collet sizes x degree of punch

Code	Description	UOM	Price
C48149	5 to 15mm with 17 Degree Punch	EACH	£179.95
C48150	14 to 21mm with 17 Degree Punch	EACH	£233.50

## Oval (O.M.O Italy) Sharp



- Collet block with sharp oval holes
- Various sizes
- 17 degree angled punch
- Overall size 100 x 90 x 25mm
- Hardened steel
- "Special K" tool steel
- O.M.O Italy

Dimensions:

- Collet sizes x degree of punch

Code	Description	UOM	Price
C48151	5 to 15mm with 17 Degree Punch	EACH	£199.95
C48152	14 to 21mm with 17 Degree Punch	EACH	£259.00

## Oval (O.M.O Italy) Sharp, Swelled

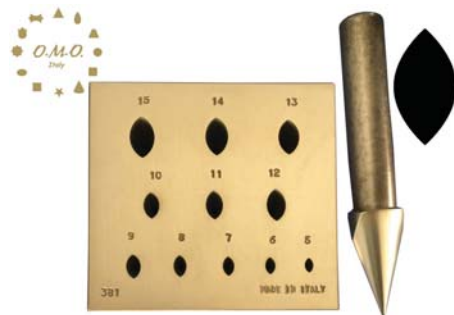

- Collet block with sharp, bloated oval holes
- Various sizes
- 17 degree angled punch
- Overall size 100 x 90 x 25mm
- Hardened steel
- "Special K" tool steel
- O.M.O Italy

Dimensions:

- Collet sizes x degree of punch

Code	Description	UOM	Price
C48153	5 to 15mm with 17 Degree Punch	EACH	£199.95
C48154	14 to 21mm with 17 Degree Punch	EACH	£259.00

Texturing  
Hammers

See Page 909



**Pentagonal (O.M.O Italy)**



- Collet block with pentagonal holes
- Various sizes
- 17 degree angled punch
- Overall size 100 x 90 x 25mm
- Hardened steel
- "Special K" tool steel
- O.M.O Italy

Dimensions:

- Collet sizes x degree of punch

Code	Description	UOM	Price
C48112	4 to 14mm with 17 Degree Punch	EACH	£64.95
C48113	14 to 21mm with 17 Degree Punch	EACH	£120.20

**Rectangular (O.M.O Italy)**



- Collet block with rectangular holes
- Various sizes
- 17 degree angled punch
- Overall size 100 x 90 x 25mm
- Hardened steel
- "Special K" tool steel
- O.M.O Italy

Dimensions:

- Collet sizes x degree of punch

Code	Description	UOM	Price
C48123	4 x 2.8mm to 14 x 10mm with 17 Degree Punch	EACH	£74.95
C48116	5 x 2.5mm to 15 x 7.5mm with 17 Degree Punch	EACH	£74.95
C48139	6 x 2mm to 16 x 12mm with 17 Degree Punch	EACH	£74.95
C48135	6 x 3mm to 16 x 13mm with 17 Degree Punch	EACH	£74.95
C48131	6 x 4mm to 16 x 14mm with 17 Degree Punch	EACH	£74.95
C48127	6 x 5mm to 16 x 15mm with 17 Degree Punch	EACH	£74.95
C48117	14 x 7mm to 21 x 11mm with 17 Degree Punch	EACH	£120.20
C48132	14 x 9mm to 21 x 14 with 17 Degree Punch	EACH	£120.20
C48124	14 x 10mm to 21 x 15mm with 17 Degree Punch	EACH	£120.20
C48136	14 x 11mm to 21 x 17mm with 17 Degree Punch	EACH	£120.20
C48128	14 x 13mm to 21 x 20mm with 17 Degree Punch	EACH	£120.20

**Rectangular (O.M.O Italy) Chamfered Corners**



- Collet block with rectangular holes with chamfered corners
- Various sizes
- 17 degree angled punch
- Overall size 100 x 90 x 25mm
- Hardened steel
- "Special K" tool steel
- O.M.O Italy

Dimensions:

- Collet sizes x degree of punch

Code	Description	UOM	Price
C48125	4 x 2.8mm to 14 x 10mm with 17 Degree Punch	EACH	£78.95
C6530	5 x 2.5mm to 15 x 7.5mm with 17 Degree Punch	EACH	£76.95
C48141	6 x 2mm to 16 x 12mm with 17 Degree Punch	EACH	£79.95
C48137	6 x 3mm to 16 x 13mm with 17 Degree Punch	EACH	£79.95
C48133	6 x 4mm to 16 x 14mm with 17 Degree Punch	EACH	£79.95
C48129	6 x 5mm to 16 x 15mm with 17 Degree Punch	EACH	£79.95
C48118	14 x 7mm to 21 x 11mm with 17 Degree Punch	EACH	£120.20
C48142	14 x 9mm to 21 x 14 with 17 Degree Punch	EACH	£120.20
C48126	14 x 10mm to 21 x 15mm with 17 Degree Punch	EACH	£120.20
C48138	14 x 11mm to 21 x 17mm with 17 Degree Punch	EACH	£120.20
C48134	14 x 12mm to 21 x 18mm with 17 Degree Punch	EACH	£120.20
C48130	14 x 13mm to 21 x 20mm with 17 Degree Punch	EACH	£120.20

**Rectangular (O.M.O Italy) Rounded Corners**

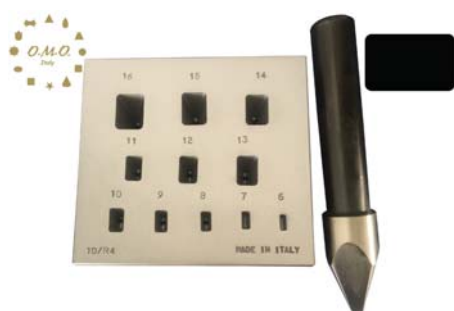

- Collet block with rectangular holes with rounded corners
- Various sizes
- 17 degree angled punch
- Overall size 100 x 90 x 25mm
- Hardened steel
- "Special K" tool steel
- O.M.O Italy

Dimensions:

- Collet sizes x degree of punch

Code	Description	UOM	Price
C48169	6 x 2mm to 16 x 12mm with 17 Degree Punch	EACH	£179.95

C48167	6 x 3mm to 16 x 13mm with 17 Degree Punch	EACH	£179.95
C48165	6 x 4mm to 16 x 14mm with 17 Degree Punch	EACH	£179.95
C48163	6 x 5mm to 16 x 15mm with 17 Degree Punch	EACH	£179.95
C48168	14 x 7mm to 21 x 11mm with 17 Degree Punch	EACH	£233.50
C48166	14 x 9mm to 21 x 14mm with 17 Degree Punch	EACH	£233.50
C48170	14 x 10mm to 21 x 15mm with 17 Degree Punch	EACH	£233.50

**Rectangular (O.M.O Italy) Swelled**



- Collet block with swelled rectangular holes (rounded edges giving a swelled rectangle look)
- Various sizes
- 17 Degree angled punch
- Overall size 100 x 90 x 25mm
- Hardened steel
- "Special K" tool steel
- O.M.O Italy

Dimensions:

- Collet sizes x degree of punch

Code	Description	UOM	Price
C48143	4 x 4mm to 14 x 14mm with 17 Degree Punch	EACH	£79.95
C48144	14 x 14mm to 21 x 21mm with 17 Degree Punch	EACH	£120.20

**Round (O.M.O Italy)**



- Collet block with round holes
- Various sizes
- Various degree punches available
- Overall size 100 x 90 x 25mm
- Hardened steel
- "Special K" tool steel
- O.M.O Italy

Dimensions:

- Collet sizes x degree of punch

Code	Description	UOM	Price
C48099	Ø3 to Ø13mm with 17 Degree Punch	EACH	£44.95
C6534	Ø5 to Ø20mm with 17 Degree Punch	EACH	£59.95
C6533	Ø5 to Ø20mm with 28 Degree Punch	EACH	£59.95
C48100	Ø5 to Ø20mm with 32 Degree Punch	EACH	£59.95



**ONLINE ORDER STATUS**



**SAME DAY DISPATCH**

## Round (Wheatsheaf UK)

- Collet block with round holes
- Various sizes
- Various degree punches available
- Hardened Steel
- Overall size: 100 x 45 x 13mm
- Made In UK



Code	Description	UOM	Price
C4237	Ø3 to Ø13mm with 17 Degree Punch	EACH	£37.95
C4335	Ø5 to Ø19mm with 28 Degree Punch	EACH	£35.50

## Square (O.M.O Italy)



- Collet block with square holes
- Various sizes
- 17 degree angled punch
- Overall size 100 x 90 x 25mm
- Hardened steel
- "Special K" tool steel
- O.M.O Italy

Dimensions:  
• Collet sizes x degree of punch

Code	Description	UOM	Price
C6532	4 to 14mm with 17 Degree Punch	EACH	£59.95
C48114	14 to 21mm with 17 Degree Punch	EACH	£120.20

## Square (O.M.O Italy) Chamfered Corners



- Collet block with square holes with chamfered corners
- Various sizes
- 17 degree angled punch
- Overall size 100 x 90 x 25mm
- Hardened steel
- "Special K" tool steel
- O.M.O Italy

Dimensions:  
• Collet sizes x degree of punch

Code	Description	UOM	Price
C6536	4 to 14mm with 17 Degree Punch	EACH	£63.95
C48115	14 to 21mm with 17 Degree Punch	EACH	£120.20

## Square (O.M.O Italy) Swelled



- Collet block with square swelled holes (rounded edges giving a swelled square look)
- Various sizes
- 17 degree angled punch
- Overall size 100 x 90 x 25mm
- Hardened steel
- "Special K" tool steel
- O.M.O Italy

Dimensions:  
• Collet sizes x degree of punch

Code	Description	UOM	Price
C48155	4 x 4 to 14 x 14mm with 17 Degree Punch	EACH	£179.95
C48156	14 x 14 to 21 x 21mm with 17 Degree Punch	EACH	£233.50

## Tear Drop (Pear) (O.M.O Italy)



- Collet block with tear drop (pear shape) holes
- Various sizes
- 17 degree angled punch
- Overall size 100 x 90 x 25mm
- Hardened steel
- "Special K" tool steel
- O.M.O Italy

Code	Description	UOM	Price
C6535	4 to 14mm with 17 Degree Punch	EACH	£89.95
C48103	14 to 21mm with 17 Degree Punch	EACH	£120.20

## Tear Drop (Pear) Narrow (O.M.O Italy)



- Collet block with narrow tear drop (pear shape) holes
- Various sizes
- 17 degree angled punch
- Overall size 100 x 90 x 25mm
- Hardened steel

- "Special K" tool steel
- O.M.O Italy

Code	Description	UOM	Price
C48104	4 to 14mm with 17 Degree Punch	EACH	£89.95
C48105	14 to 21mm with 17 Degree Punch	EACH	£120.20

## Triangular (O.M.O Italy)



- Collet block with triangular holes
- Various sizes
- 17 degree angled punch
- Overall size 100 x 90 x 25mm
- Hardened steel
- "Special K" tool steel
- O.M.O Italy

Dimensions:  
• Collet sizes x degree of punch

Code	Description	UOM	Price
C48121	4 to 14mm with 17 Degree Punch	EACH	£74.95
C48122	14 to 21mm with 17 Degree Punch	EACH	£120.20

## Triangular (O.M.O Italy) with One Curved Edge



- Collet block with triangular holes that have one curved edge (quarter circle shape)
- Various sizes
- 17 degree angled punch
- Overall size 100 x 90 x 25mm
- Hardened steel
- "Special K" tool steel
- O.M.O Italy

Dimensions:  
• Collet sizes x degree of punch

Code	Description	UOM	Price
C48157	5 to 15mm with 17 Degree Punch	EACH	£179.95
C48158	14 to 21mm with 17 Degree Punch	EACH	£233.50



Alphabetical & Numerical Punch Sets

See Page 969



## Triangular (O.M.O Italy) Swelled



- Collet block with swelled triangular holes (rounded edges giving a swelled triangle look)
- Various sizes
- Various degree punches available
- Overall size 100 x 90 x 25mm
- Hardened steel
- "Special K" tool steel
- O.M.O Italy

Dimensions:

- Collet sizes x degree of punch

Code	Description	UOM	Price
C48159	5 to 15mm with 17 Degree Punch	EACH	£199.95
C48160	14 to 21mm with 17 Degree Punch	EACH	£259.00

## CUPOLA SETS



*Cupola derives from the latin term "cupula", and is a term meaning a domed structure often seen in churches, temples, mosques and many places of worship/venue halls*

*Create Cupola traditional arts/craft Jewellery with our various varieties of sets small, medium, large and full set.*

- Popular with necklace designs using as a centre piece or simply on its own
- High quality dapping sets for the professional crafts person, jeweller, silversmith and artist metal worker
- All pieces hardened, ground and highly polished for the perfect results
- Sets are available in a plastic carry case or wooden stand

## Ø50mm & Ø57mm, Durston

Cupola Set - Small - Durston

- Set includes 3 pieces with sturdy carry stand
- 2 Punches sizes Ø50mm & Ø57mm
- 1 double sided base
- With plastic carry case
- Durston 1112
- Made in Great Britain

Weight: 4kg



Code	Description	UOM	Price
C35091	Small Cupola Set, Durston	PACK*3	£64.95

## Ø64mm & Ø71mm, Durston

Cupola Set - Medium - Durston

- Set includes 3 pieces with sturdy carry stand
- 2 Punches sizes Ø64mm & Ø71mm
- 1 double sided base
- With plastic carry case
- Durston 1113
- Made in Great Britain

Weight: 4.5kg



Code	Description	UOM	Price
C35092	Medium Cupola Set, Durston	PACK*3	£84.95

## Ø78mm & Ø85mm, Durston

Cupola Set - Large - Durston

- Set includes 3 pieces with sturdy carry stand
- 2 Punches sizes Ø78mm & Ø85mm
- 1 double sided base
- With plastic carry case
- Durston 1114
- Made in Great Britain

Weight: 7kg



Code	Description	UOM	Price
C35093	Large Cupola Set, Durston	PACK*3	£114.95

## Complete Set, Durston



Cupola Set - Complete - Durston

- Punches/Base sizes: 50mm, 57mm, 64mm, 71mm, 78mm, and 85mm
- With plastic carry case
- Durston 1111
- Made in Great Britain

Weight: 14kg

Code	Description	UOM	Price
C35090	Complete Cupola Set, Durston	PACK*9	£215.00

## Gilbow Cutting Shears

See Page 830



## Ø55mm & Ø60mm



Cupola Set - Indian

- Set includes 3pcs
- Punches/base sizes Ø55mm – Ø60mm
- With wooden storage stand
- Non EU

Weight: 4.5kg

Code	Description	UOM	Price
D34921	Cupola Set, Indian	PACK*3	£27.50

## Complete Set, Indian



Cupola Set - Complete - Wooden

- 4 punches
- 2 reversible bases
- Punches/Base sizes: Ø40, 45, 50 & 60mm
- With wooden base
- Sizes marked on base
- Made in India

Weight: 1Kg

Code	Description	UOM	Price
C39419	Complete Cupola Set, Wooden	EACH	£29.95

## DISC CUTTERS

*Disc Cutters are used in the design and manufacture of jewellery such as bracelets, earrings, necklaces, pendants and broaches, for contemporary or traditional designs.*

*Cutting or saw piecing circles can be arduous to perfect the complete shape; therefore disc cutters are used to cut out circular pieces from sheet metal quickly and precisely. We hold a wide range of disc cutting tools which cover a variety of sizes from 2mm to 24mm, including high quality and economic sets. The Italian and English cutters have exceptional quality and are made to a very high standard using the best grade tool steel. These tools can last a working lifetime.*

*Disc Cutters are made from hardened tool steel and constructed and designed to cut soft metals such as gold, silver, copper, brass, aluminium, tin, gilding metal, bronze and pewter as well as textiles such as leather. We recommend cutting up to 1mm diameter of sheet metal with any of our disc cutters, based on gold and silver.*

Some handy tips when using a disc cutter:

Select the corresponding cutting punch for the hole to be cut. Spray the area with WD40 (code C32756) to lubricate the cutting punch, this fine and inexpensive oil is ideal to use with these tools. Remove the punch from the cutting whole and place the sheet into the side slit, strike the top of the punch firmly with a hammer (code H9621) the cutter punch will puncture the piece and push out the disc.

We recommend these hammers to use with the following cutting punches when using our disc cutter range...

Use H5107 Ball Pein Hammer with Disc cutting tools D5206, D200869 and D4225. Use H33138, 16oz Blocking Hammer with Disc Cutting Tool, D8351.

View our range of forming tools, particularly Doming Blocks and Punches, highly suitable to use with disc cutting tools when designing and making.

## 2 Diameters, Ø35 & Ø45mm



- Disc cutter set of 2
- Extra large disc cutter
- Rectangular base
- Hole Ø35 & Ø45mm (marked in imperial & metric sizes)
- Can be used with a hydraulic press
- Rockwell hardness rating 60, tool lasts longer than similar items on the market
- High grade D3 tool steel
- Maximum sheet thickness 2mm
- Made in India

Size and weight:  
• 125 x 60 x 40mm  
• Weight: 2.7Kg

Code	Description	UOM	Price
D39421	2 Diameters, Ø35 & Ø45mm	EACH	£54.50

## 5 Diameters, Ø12 to Ø25mm



- Disc cutter set of 5
- Square base
- Hole Ø12, 15, 19, 22 & 25mm (marked in imperial sizes)
- Rockwell hardness rating 60, tool lasts longer than similar items on the market
- High grade D3 tool steel
- Maximum sheet thickness 2mm
- Made in India

Size and weight:  
• 75 x 70 x 40mm  
• Weight: 1.18Kg

Code	Description	UOM	Price
D35519	5 Diameters, Ø12 to Ø25mm	EACH	£25.95

## 6 Diameters, Ø19 to Ø24mm, Italian



- Large Hole Diameter Disk Cutter
- Heavy duty version for heavier sheet Sizes
- Hole Ø19, 20, 21, 22, 23 & 24mm
- Maximum sheet thickness 5mm
- O.M.O Italy

Size and weight:  
• 150mm x 130mm x 130mm  
• Weight: 6.6 kg

Code	Description	UOM	Price
D8351	6 Diameters, Ø19 to Ø24mm, Italian	EACH	£295.00

## 7 Diameters, Ø3 to Ø12.5mm



- Disc cutter set of 7
- Square base
- Spring loaded with handle
- Holes: Ø3, 4.5, 6.2, 8, 9.5, 11 & 12.5mm (marked in imperial sizes)
- Rockwell hardness rating 60, tool lasts longer than similar items on the market
- High grade D3 tool steel
- Maximum sheet thickness 2mm
- Made in India

Size and weight:  
• 70 x 75 x 30mm  
• Weight: 1.5Kg

Code	Description	UOM	Price
D39420	7 Diameters, Ø3 to Ø12.5mm	EACH	£24.95

## Centre Positioning Dies



- Centre positioning dies for your disc cutter
- Allows you to cut perfect washer shape discs
- 10 sizes: Ø3, 6, 9, 13, 16, 19, 22, 25, 28 & 32mm
- Durston dies are specific to Durston disc cutters
- The Indian dies are specific to disc cutter D48079 & cannot be used with other disc cutters
- Pack\*10

Code	Description	UOM	Price
D45774	Centre Positioning Dies, Durston	PACK*10	£69.95
D45780	Centre Positioning Dies	PACK*10	£23.95

## Ball Pein Hammers

See Page 906



## Piercing or Fret Saws & Blades

See Page 982



## Bangle & Bracelet Holding Tools

See Page 772



## Doming Blocks & Punches

See Page 875



7 Diameters, Ø6 to Ø15mm



- Disc cutter set of 7
- Round base
- Sizes: Ø6.3, 7.8, 9.5, 11, 12.6, 14.2, 15.8mm
- Rockwell hardness rating 60, tool lasts longer than similar items on the market
- High grade D3 tool steel
- Maximum sheet thickness 2mm

Size & Weight:  
 • 63mm Diameter  
 • Weight: 600g

This precision cutting tool is made from high quality steel.

Used for cutting round discs with ease and accuracy.

Made in India.

Code	Description	UOM	Price
D34920	7 Diameters, Ø6 to Ø15mm (Round Base)	EACH	£13.95

7 Diameters, Ø6 to Ø15mm



- Disc cutter set of 7
- Square base
- Hole Ø6, 7, 9, 11, 12, 14, & 15mm (marked in imperial sizes)
- Maximum sheet thickness 2mm
- Rockwell hardness rating 60, tool lasts longer than similar items on the market
- High grade D3 tool steel
- Made in India

Size and weight:  
 • 60 x 60 x 40mm  
 • Weight: 760g

Code	Description	UOM	Price
D35520	7 Diameters, Ø6 to Ø15mm (Square Base)	EACH	£26.10

8 Diameters, Ø4.5 to Ø16mm, UK



- 8 Punch disc cutter, on square base
- Material is put between the two halves of the die, the corresponding punch is knocked down to cut the circle from the material. Mallet/hammer is used to knock punches.
- Punch sizes: Ø4.50, 6.30, 7.90, 9.50, 11.00, 12.50, 14.00 & 15.80mm
- Maximum sheet thickness 3mm

Made in UK

Size: 65 x 65 x 45mm

Weight: 1.1kg

Code	Description	UOM	Price
D4225	8 Diameters, Ø4.5 to Ø16mm, UK	EACH	£79.95

10 Diameters, Ø3 to Ø32mm, Durston



Yet another well engineered tool from Durston. This is an excellent precision disc cutter. Looked after properly this tool will last a life time & possibly beyond

- Punches made from special tool steel, hardened and ground. Ends of the punches are ground at a perfect angle for great results giving you a precise cut minimising the need for de-burring after
- 10 punches sizes: Ø3, 6, 9, 13, 16, 19, 22, 25, 28, 32mm
- Punches are hardened to Rockwell hardness rating of 62
- Spring loaded die plate allows easy clamping of the material & is lockable with an Allen key (supplied)
- All components fit neatly into plastic carrying tray with metal handles
- 10 punches fit into an additional integral tray that can be removed if required
- Punches also have separate, removable carrying tray (that also fits in the main tray)
- Maximum sheet thickness 3mm
- Weight 7.5Kg
- Durston 1201
- Made in UK

Included:

- Durston spring loaded die plate
- 10 punches with separate carry tray
- Plastic carry tray with metal handles
- Urethane pad to absorb energy of hammer blows
- Punch lubricant
- Set of shims to level up when punching holes

• Allen key

Code	Description	UOM	Price
D45635	10 Diameters, Ø3 to Ø32mm, Durston	EACH	£174.95
D46049	Ø6mm Disc Cutter Punch	EACH	£24.95

10 Diameters, Ø3 to Ø32mm



- Disc cutter set of 10
- Supplied with rubber base
- 10 sizes: Ø3, 6, 9, 13, 16, 19, 22, 25, 28 & 32mm
- Rockwell hardness rating 60, tool lasts longer than similar items on the market
- High grade D3 tool steel
- Maximum sheet thickness 2mm
- Centre positioning dies available, our code D45870

Size & Weight:

- Ø110mm Diameter
- Weight: 3.4Kg

Code	Description	UOM	Price
D48079	10 Diameters, Ø8 to Ø32mm	EACH	£69.95

14 Diameters, Ø3 to Ø16mm



- Disc cutter set of 14 hardened cutters
- Rectangular base
- Sizes: Ø3, 4.5, 5, 6, 7, 7.5, 8, 8.5, 10, 11, 12, 13, 14 & 16mm
- Rockwell hardness rating 60, tool lasts longer than similar items on the market
- High grade D3 tool steel
- Used for cutting round discs with ease and accuracy
- Max sheet capacity 2mm

Size & Weight:

- 110mm x 50mm x 33mm
- Weight: 1.1kg

Code	Description	UOM	Price
D20869	14 Diameters, Ø3 to Ø16mm	EACH	£21.95

PRICE PROMISE  
 GUARANTEE

Fine Oil Spray

See Page 1180



www. Online Discounts



**14 Diameters, Ø3 to Ø25mm**



- Disc cutter set of 14 hardened cutters
- Round base
- Sizes: Ø3mm to Ø25mm
- Sizes marked on the plate
- Rockwell hardness rating 60, tool lasts longer than similar items on the market
- High grade D3 tool steel
- Used for cutting round discs with ease and accuracy
- Maximum sheet cutting thickness 2mm
- Base Ø140mm
- Weight: 1.1kg

Code	Description	UOM	Price
D41194	14 Diameters, Ø3 to Ø25mm	EACH	£65.95

- Rockwell hardness rating 60, tool lasts longer than similar items on the market
- High grade D3 tool steel
- Rectangular base
- Can be used with a hydraulic press
- Maximum sheet thickness 2mm
- Made in India

Code	Description	UOM	Price
D44125	Disc Cutter, Multishaped	EACH	£119.95

**Multi Shaped Disc Cutter (Geometric Shapes)**

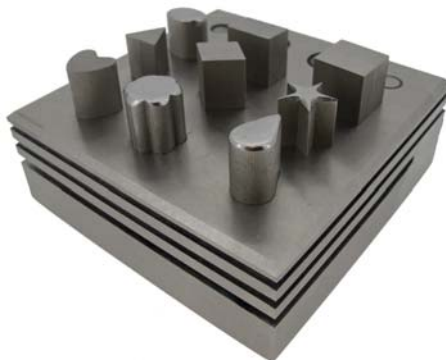

- Multi shaped disc cutter
- 9 shapes: Flower, oval, tear drop, diamond, star, heart, triangle, rectangle & square
- Rockwell hardness rating 60, tool lasts longer than similar items on the market
- High grade D3 tool steel
- Rectangular base
- Can be used with a hydraulic press
- Maximum sheet thickness 2mm
- Made in India

Code	Description	UOM	Price
D42094	Multi Shaped Disc Cutter	EACH	£125.00

**Flower Disc Cutter**



- Flower disc cutter
- 4 sizes: Ø10, 15, 20 & 25mm
- Rockwell hardness rating 60, tool lasts longer than similar items on the market
- High grade D3 tool steel
- Rectangular base
- Can be used with a hydraulic press
- Maximum sheet thickness 2mm
- Made in India
- Base 75 x 80mm
- 1.4Kg

Code	Description	UOM	Price
D40309	Flower Disc Cutter	EACH	£134.95

**Heart Disc Cutter**



- Heart disc cutter
- 5 sizes: 10 x 12, 12 x 15, 15 x 18, 20 x 24 & 20 x 25mm
- Rockwell hardness rating 60, tool lasts longer than similar items on the market
- High grade D3 tool steel
- Rectangular base
- Can be used with a hydraulic press
- Maximum sheet thickness 2mm
- Made in India
- Base 75 x 80mm
- 1.4Kg

Code	Description	UOM	Price
D40307	Heart Shapes Disc Cutter	EACH	£139.95

**Hexagon Disc Cutter**



- Hexagon disc cutter
- 5 sizes: Ø12, 15, 18, 21 & 24mm
- Rockwell hardness rating 60, tool lasts longer than similar items on the market
- High grade D3 tool steel
- Rectangular base
- Can be used with a hydraulic press
- Maximum sheet thickness 2mm
- Made in India
- Base 75 x 80mm
- 1.4Kg

Code	Description	UOM	Price
D40308	Hexagon Shapes Disc Cutter	EACH	£165.00

**18 Diameters, Ø2 to Ø12mm, Italian**



- 18 Punch Disc Cutter central slot for positioning sheet under corresponding punch.
- Punch Sizes: Ø2 to 12mm
- Round Base
- O.M.O Italy
- Size & Weight:
- 100mm x 65mm
- Weight: 2.7kg

Code	Description	UOM	Price
D5206	18 Diameters, Ø2 to Ø12mm, Italian	EACH	£185.00

**Multi Shaped Disc Cutter**



- Multi shaped disc cutter
- 9 shapes: Dog, tear drop, octagon, Christian cross, bird, thin heart, eye, heart & butterfly

**Mallets & Hammers**  
See Page 911

## Oval Disc Cutter



- Oval disc cutter
- 7 sizes: 6 x 4, 8 x 6, 10 x 8, 12 x 10, 14 x 10, 16 x 14 & 18 x 16mm
- Rockwell hardness rating 60, tool lasts longer than similar items on the market
- High grade D3 tool steel
- Rectangular base
- Can be used with a hydraulic press
- Maximum sheet thickness 2mm
- Made in India
- Base 75 x 80mm
- 1.4Kg

Code	Description	UOM	Price
D40304	Oval Shapes Disc Cutter	EACH	£127.95

## Square Disc Cutter



- Square disc cutter
- 7 sizes: 4, 6, 8, 10, 12, 14 & 16mm
- Rockwell hardness rating 60, tool lasts longer than similar items on the market
- High grade D3 tool steel
- Rectangular base
- Can be used with a hydraulic press
- Maximum sheet thickness 2mm
- Made in India
- Base 75 x 80mm
- 1.4Kg

Code	Description	UOM	Price
D40310	Square Disc Cutter	EACH	£110.00

**TODAY** SAME DAY DISPATCH

## Square & Rectangle Disc Cutter



- Square & rectangle disc cutter
- 4 sizes: 10, 15, 20 & 12 x 25mm
- Rockwell hardness rating 60, tool lasts longer than similar items on the market
- High grade D3 tool steel
- Rectangular base
- Can be used with a hydraulic press
- Maximum sheet thickness 2mm
- Made in India
- Base 75 x 80mm
- 1.4Kg

Code	Description	UOM	Price
D40306	Sqaure & Rectangle Disc Cutter	EACH	£114.95

## Star Disc Cutter



- Star disc cutter
- 5 sizes: Ø12, 15, 18, 21 & 25.5mm
- Rockwell hardness rating 60, tool lasts longer than similar items on the market
- High grade D3 tool steel
- Rectangular base
- Can be used with a hydraulic press
- Maximum sheet thickness 2mm
- Made in India
- Base 75 x 80mm
- 1.4Kg

Code	Description	UOM	Price
D40305	Star Disc Cutter	EACH	£135.00

**IMPROVED SPEED SEARCH**

## DRAW PLATES

A draw plate is a multi-die plate made of hardened steel which wire is drawn through to thin it. Our Draw Plates are available in many different shapes and sizes including round, square, oval, half-round rectangular square and triangular for reducing and forming different shaped wire. The drawing holes on the plate are wider at the rear and taper slightly towards the front.

Method:

- Prepare the wire by hammering, filing, rolling or swaging, to reduce it, in order for it to fit through the die; the wire is then ready to be pulled through the die.
- During this process the volume of the wire remains the same, so as the diameter decreases, the length increases.
- Usually the wire requires to be drawn through several dies, allowing the wire to gradually decrease until the desired size is reached, to ensure the longevity of the die plate.
- When drawing, anneal the wire first and file at one end to taper it.
- Measure the diameter of the wire and insert the tapered end into a die hole the closest size smaller to its diameter.
- Use Draw Tongs (D6239) to hold and pull the wire through the die. Sometimes it may be necessary to lubricate the wire with grease or wax, see our code P1406.
- A wire can be drawn up to three times consecutively before it needs to be re-annealed. The drawing process makes the wire brittle, not re-annealed the wire can cause snapping.
- Metals such as gold, silver, copper, brass, bronze and pewter can be drawn through a regular steel plate, whereas stronger metals such as platinum, titanium and palladium wire are recommended to be drawn through a tungsten carbide plate for durability. All metals drawn with this plate, however, will have a polished finish coat.
- Every draw plate we stock is made from the very best hardened steel to ensure optimum longevity.

The above picture is of a round hole steel draw plate with 31 Holes Ø3.00 to 6.00mm (code D4458) and a heavy duty workshop vice (code V33154) holding it.

Below is a guide for making round tube with this item...

Formula to find the circumference of a round tube: Multiply diameter by 3.1416

- Depending on the size of the tube to be made, cut the sheet to the desired strip width considering the formula above.
- Remove the sharp edge of the sheet to make drawing easier by using a Deburring Tool with Pocket Clip (Code B31879).
- Prepare one end by cutting it to a point so it will fit through the preferred die size. Ensure the point is long enough so the wire can be pulled through the die with a draw tong easily (code D6239).
- Coat the edges with Beeswax (P1406) to lubricate.
- Secure the draw plate in a vice and draw the wire, this will achieve the tubular shape illustrated in the picture above.
- Finally, use a Tube Cutting Jig with Sizing Gauge (T31883) to cut the tube to the length you would like which is now ready to be soldered.

**Steel by Shape**



**Draw Plate**

Comprehensive selection of draw plates

- Unbelievably good value for money
- Various shapes and sizes available
- Handy for wax wire shaping
- Made in India

Please note not recommended to draw platinum and is advisable to anneal your metals to soften before drawing

**D Shape (30 holes) Ø3.50 to 6.70mm**



- Half Round (D Shape)
- 30 holes
- Overall size: 205 x 30 x 5mm

Code	Description	UOM	Price
D35069	D Shape (30 holes) Ø3.50 to 6.70mm	EACH	£3.50

**Hexagonal (30 holes) 1.60 to 5.00mm**



- Hexagonal holes
- 30 holes
- Overall size: 205 x 30 x 5mm

Code	Description	UOM	Price
D35068	Hexagonal (30 holes) 1.60 to 5,00mm	EACH	£3.50

**Oval (30 holes) 1.40 x 3.20 to 3.00 x 6.00mm**



- Oval hole
- 30 holes
- Overall size: 205 x 30 x 5mm

Code	Description	UOM	Price
D35067	Oval (30 holes) 1.40 x 3.20 to 3.00 x 6.00mm	EACH	£3.50

**Rectangular (30 holes) 1.20 x 3.00 to 2.50 x 6.00mm**



- Rectangular Hole

- 30 holes
- Overall size: 205 x 30 x 5mm

Code	Description	UOM	Price
D35079	Rectangular (30 holes) 1.20 x 3.00 to 2.50 x 6.00mm	EACH	£3.50

**Round (63 holes) Ø0.30 to 1.60mm**



- Round hole
- 63 holes
- Overall size: 115 x 25 x 5mm

Code	Description	UOM	Price
D35059	Round (63 holes) Ø0.30 to 1.60mm	EACH	£3.50

**Round (71 holes) Ø0.30 to 2.70mm**



- Round hole
- 71 holes
- Ø0.30 to 2.70mm
- Overall size: 165 x 25 x 5mm

Code	Description	UOM	Price
D35060	Round (71 holes) Ø0.30 to 2.70mm	EACH	£3.50

**Round (82 holes) Ø0.80 to 2.50mm**



- Round hole
- 82 holes
- Overall size: 255 x 30 x 6mm

Code	Description	UOM	Price
D35061	Round (82 holes) Ø0.80 to 2.50mm	EACH	£3.50

**Round (91 holes) Ø0.70 to 4.00mm**



- Round hole
- 91 holes
- Overall size: 255 x 30 x 6mm

Code	Description	UOM	Price
D35062	Round (91 holes) Ø0.70 to 4,00mm	EACH	£3.50

**Round (30 holes) Ø1.50 to 4.30mm**



- Round hole
- 30 holes
- Overall size: 215 x 30 x 5mm

Code	Description	UOM	Price
D35070	Round (30 holes) Ø1.50 to 4.30mm	EACH	£3.50

**Square (20 holes) 1.80 to 3.00mm**



- Square hole

- 20 holes
- Overall size: 155 x 25 x 5mm

Code	Description	UOM	Price
D35063	Square (20 holes) 1.80 to 3.00mm	EACH	£3.50

**Square (25 holes) 2.00 to 3.30mm**



- Square hole
- 25 holes
- Overall size: 155 x 25 x 5mm

Code	Description	UOM	Price
D35064	Square (25 holes) 2.00 to 3.30mm	EACH	£3.50

**Square (25 holes) 2.30 to 3.40mm**



- Square hole
- 25 holes
- Overall size: 155 x 25 x 5mm

Code	Description	UOM	Price
D35065	Square (25 holes) 2.30 to 3.40mm	EACH	£3.50

**Square (30 holes) 1.60 to 4.30mm**



- Square hole
- 30 holes
- Overall size: 205 x 30 x 5mm

Code	Description	UOM	Price
D35066	Square (30 holes) 1.60 to 4.30mm	EACH	£3.50

**Tear Drop (30 holes) 1.50 x 2.50 to 3.70 x 5.00mm**



- Tear Drop Holes
- 30 Holes
- Overall size: 205 x 30 x 5mm

Code	Description	UOM	Price
D35071	Tear Drop (30 holes) 1.50 x 2.50 to 3.70 x 5.00mm	EACH	£3.50

**Triangular (30 holes) 2.00 to 4.50mm**



- Triangular Holes
- 30 Holes
- Overall size: 195 x 30 x 5mm

Code	Description	UOM	Price
D35072	Triangular (30 holes) 2.00 to 4.50mm	EACH	£3.50

PRICE PROMISE GUARANTEE

## Steel by Shape, A\*F Swiss

Draw Plates - A\*F Swiss

Comprehensive selection of draw plates

- A\*F Swiss
- Various shapes and sizes available
- Handy for wax wire shaping

Please note not recommended to draw platinum and is advisable to anneal your metals to soften before drawing

### D Shape (20 holes) Ø1.00 to 3.00mm



A\*F Swiss

- Half Round (D shaped)
- 20 Holes Ø1.00 to 3.00mm
- Overall size: 170 x 35 x 8mm
- Hardened Steel, A\*F Swiss 149.550A

Code	Description	UOM	Price
D4453	D Shape (20 holes) Ø1.00 to 3.00mm	EACH	£78.95

### Oval (31 holes) Ø3.00 to 6.00mm



A\*F Swiss

- Oval Hole Draw Plate
- 31 Holes Ø3.00 to 6.00mm
- Overall size: 235 x 50 x 10mm
- Hardened Steel, A\*F Swiss 149.552

Code	Description	UOM	Price
D4454	Oval (31 holes) Ø3.00 to 6.00mm	EACH	£47.95

### Rectangular (20 holes) 0.50 x 1.40 to 1.00 x 3.00mm



A\*F Swiss

- 20 Holes: widths: 0.50 to 1.00mm, Lengths: 1.40 to 3.00mm
- Overall size: 165 x 35 x 7mm
- Hardened Steel, A\*F Swiss 149.554A

Code	Description	UOM	Price
D4456	Rectangular (20 holes) 0.50 x 1.40 to 1.00 x 3.00mm	EACH	£42.25

### Round (31 holes) Ø3.00 to 6.00mm



A\*F Swiss

- 31 Holes Ø3.00 - 6.00mm
- Overall size: 235 x 50 x 9.5mm
- Hardened Steel, A\*F Swiss 149.556

Code	Description	UOM	Price
D4458	Round (31 holes) Ø3.00 to 6.00mm	EACH	£59.95

### Square (31 holes) 0.50 to 3.00mm



A\*F Swiss

- Square Hole Draw Plate
- 31 Holes, Range 0.50 to 3.00mm
- Overall size: 165 x 35 x 7mm
- Hardened Steel, A\*F Swiss 149.553A

Code	Description	UOM	Price
D4455	Square (31 holes) 0.50 to 3.00mm	EACH	£79.95

### Triangular (31 holes) 3.00 to 6.00mm



A\*F Swiss

- Triangular Draw Plate
- 31 Holes, Range 3.00 to 6.00mm
- Overall size: 235 x 50 x 9.5mm
- Hardened Steel, A\*F Swiss 149.555

Code	Description	UOM	Price
D4457	Triangular (31 holes) 3.00 to 6.00mm	EACH	£50.25

## Steel Multishape



Draw Plate - Multishape

- 10 Square (2.50 to 3.50mm)
- 10 Triangular (2.60 to 3.60mm)
- 10 Half Round (Ø3 to Ø4.80mm)
- 10 Oval (Ø3.00 to Ø4.00mm)
- Unbelievably good value for money
- Handy for wax wire shaping
- Made in India

Please note not recommended to draw platinum and is advisable to anneal your metals to soften before drawing

Code	Description	UOM	Price
D37133	Draw Plate, Multi Shape	EACH	£4.95

## Tungsten, Round

Draw Plates - Tungsten

Round hole tungsten carbide draw plates are extremely durable and if looked after properly will last a life time, in fact you may even pass it down!

- Some of the best features of having a tungsten carbide draw plate is you will notice the wire coming out highly polished.
- Excellent range of sizes going down to very fine perfect to do filigree jewellery work
- Smooth cutting action as tungsten cutting dies bits stay sharp
- Tungsten carbide is 3 times stiffer than steel and much denser than titanium
- Draw wires of gold, silver, platinum, palladium, copper, brass, titanium etc
- A good tip while drawing wire is to run bees wax (Cousins Ref. P1406) along the wire before entering the draw tungsten bit to get a very smooth cutting action

### Ø0.20 to 0.30mm, 5 Hole



- Tungsten holes
- Brass plate
- 5 Holes Ø0.20 to 0.30mm (31 to 35 SWG)
- Overall size: 90 x 25 x 7.5mm
- Made in India

Code	Description	UOM	Price
S39282	Ø0.20 to 0.30mm, 5 Hole	EACH	£9.95

### Ø0.26 to 2.80mm, 39 Hole, A\*F Swiss



A\*F Swiss 149.549

- Tungsten
- 39 Holes Ø0.26 to 2.80mm
- Overall size: 210 x 47 x 7.5mm

Code	Description	UOM	Price
D0432	Ø0.26 to 2.80mm, 39 Hole, A*F Swiss	EACH	£69.95

### Ø0.28 to 2.90mm, 52 Hole



- 52 Holes Ø0.28 to 2.90mm
- Overall size: 205 x 55 x 7mm
- Made in India

Code	Description	UOM	Price
D34943	Ø0.28 to 2.90mm, 52 Hole	EACH	£99.95

### Ø0.90 to 1.60mm, 5 hole



- Tungsten holes
- Brass plate
- 5 Holes Ø0.90 to 1.60mm (16 to 20 SWG)
- Overall size: 95 x 25 x 7.5mm
- Made in India

Code	Description	UOM	Price
S39281	Ø0.90 to 1.60mm, 5 hole	EACH	£9.50

### Ø2.30 to 6.00mm, 24 Hole, A\*F Swiss



A\*F Swiss 149.623

- Tungsten
- 24 Holes Ø2.30 to 6.00mm
- Overall size: 300 x 50 x 9.5mm
- Hardened Steel

Code	Description	UOM	Price
D4459	Ø2.30 to 6.00mm, 24 Hole, A*F Swiss	EACH	£92.50

**Wooden, Round**

Draw Plates - Wooden - For Soft Chain

- Round hole, rosewood draw plates
- Excellent for soft chain or wire
- Lightweight & easy to use

**Ø1.20 to 6.50mm, 12 Hole with Tang**



- Holes: Ø1.20mm to Ø6.50mm
- 12 Holes
- Rosewood
- with Tang

Code	Description	UOM	Price
D37824	Ø1.20 to 6.50mm, 12 Hole with Tang	EACH	£3.95

**Ø3.00 to 14.00mm, 12 Hole**



- Holes: Ø3.00mm to Ø14.00mm
- 12 Holes
- Rosewood
- Hand or Vice Held

Code	Description	UOM	Price
D37825	Ø3.00 to 14.00mm, 12 Hole	EACH	£5.95

**DRAW TONGS**

**120mm (26mm) with Sliding Clamp**



Overall length: 120mm  
Jaw width: 26mm  
A\*F Swiss

- Serrated jaws
- Extra wide
- Box joint for extra strength
- Very good quality
- With spring and locking ring
- Forged in toughened steel, with flat serrated jaws

Dimensions: Overall Length x (Jaw Width)

Code	Description	UOM	Price
T47199	120mm (26mm) with Sliding Clamp	EACH	£79.95

**125mm (6mm) with Sliding Clamp**

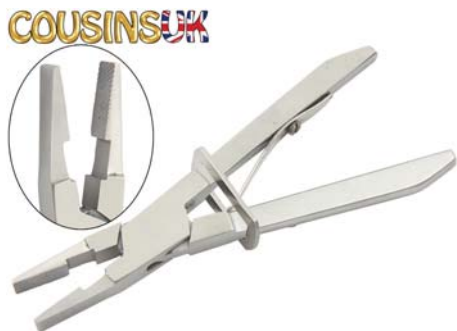

Overall length: 125mm  
Jaw width: 6mm

Cousins Swiss Style

- 6mm wide x 15mm deep jaws
- Serrated jaws
- 125mm overall length
- Box joint for extra strength
- Very good quality
- With spring and locking ring
- Weight 100g

Code	Description	UOM	Price
P48625	125mm (6mm) with Sliding Clamp	EACH	£17.95

**140mm (29mm) with Sliding Clamp**



Overall length: 140mm  
Jaw width: 29mm

Cousins Swiss Style

- 29mm wide jaws
- Serrated jaws
- 140mm overall length
- Box joint for extra strength
- Very good quality
- With spring and locking ring
- Weight 120g

Code	Description	UOM	Price
P48624	140mm (29mm) with Sliding Clamp	EACH	£19.95

**PRICE PROMISE GUARANTEE** ✓

**150mm (30mm) without Locking Clamp**



Overall length: 150mm  
Jaw width: 30mm

Cousins Swiss Style

- TBAm wide jaws
- Serrated jaws
- 150mm overall length
- Box joint for extra strength
- Very good quality
- With spring
- Weight 120g

Code	Description	UOM	Price
P48627	150mm (30mm) without Locking Clamp	EACH	£21.95

**150mm (32mm) with Sliding Clamp**



Overall length: 150mm  
Jaw width: 32mm

Draw Tong with Clamp

- Overall Length 150mm
- Jaw Width 32mm
- Light/Medium Duty

Code	Description	UOM	Price
D9474	150mm (32mm) with Sliding Clamp	EACH	£15.25

**170mm (35mm) with Sliding Clamp**



Overall length: 170mm  
Jaw width: 35mm

Cousins Swiss Style

- 35mm wide jaws
- Serrated jaws

**JUMP RING MAKING & MANUFACTURING**

**Easy Twist Tool**



Jump Ring Making - Cousins - Easy Twist

- An inexpensive tool to make your own jump rings
- Simple to use to make multiple jump rings
- Screw the preferred sized mandrel into the plastic base, hold the wire at the bottom end (nearest to the base) and place your finger into the hole and simply twist the plastic base around your finger whilst gradually letting the wire wrap up and around the mandrel
- A speedy way of making a coil, ready to cut jump rings
- Set 1: 4pcs mandrel set sizes: Ø 4mm, 6mm, 7mm, 8mm (J31876 - Small)
- Set 2: 4pcs mandrel set sizes: Ø 10mm, 12mm, 14mm, 18mm (J31877 - Large)
- Each mandrel is 95mm long, depending on the size of the wire you can make up to 100 jump rings (Based on 1mm gold wire)
- Light weight and easy to use
- Made from carbon steel
- Mandrels are threaded at the end while enables a quick and easy change over between the mandrels and the plastic holder

Size: base length 146mm x 55mm x 5mm  
 Weight: 130 grams (Set 1)  
 Weight: 475 grams (Set 2)

Code	Description	UOM	Price
J31876	Ø4 to Ø8mm Jump Ring Maker	EACH	£8.95
J31877	Ø10 to Ø18mm Jump Ring Maker	EACH	£10.95

**Hand Held Stepped Mandrels**



Jump Ring Making - Stepped

- An inexpensive tool to make your own jump rings
- Comfortable plastic holding handles
- Each stepped lengths are 18mm long, depending on the size of the wire you can make up to 25 jump rings (Based on 1mm gold wire)
- Small Mandrel Ø: 1.5, 2.5, 3.5, 4.5 & 5mm
- Large Mandrel Ø: 6, 7, 8, 9 & 10mm

- 170mm overall length
- Box joint for extra strength
- Very good quality
- With spring and locking ring
- Weight 140g

Code	Description	UOM	Price
P48626	170mm (35mm) with Sliding Clamp	EACH	£25.95

**200mm (15mm) with Curved Handle**



- Overall length: 200mm  
 Jaw width: 15mm
- For holding wire to pull through draw plates.
  - Special curved handle allowing extra pulling power and stability
  - Serrated jaws
  - Overall length 200mm
  - Jaw width 15mm
  - Jaw depth 35mm
  - Weight 480g

Code	Description	UOM	Price
D36256	200mm (15mm) with Curved Handle	EACH	£5.95

**200mm (24mm) with Ring**



- Overall length: 200mm  
 Jaw width: 24mm
- Draw Tong with Ring
  - Overall Length 200mm
  - Jaw Width 24mm
  - Jaw Depth 30mm
  - Heavy Duty
  - Hooked handles with stout pull ring

Code	Description	UOM	Price
D9473	Draw Tongs, 200mm with Ring	EACH	£9.95

**230mm (10mm) with with Screw Locking**



- Overall length: 230mm  
 Jaw width: 10mm
- Cousins Swiss Style
- 10mm wide x 60mm deep jaws
  - Maximum jaw opening 70mm
  - Serrated jaws
  - 230mm overall length
  - Box joint for extra strength
  - Very good quality
  - With screw locking system
  - Weight 100g

Code	Description	UOM	Price
P48628	230mm (10mm) with Grip Locking	EACH	£15.95

**250mm (15mm) with Curved Handle**



- Overall length: 250mm  
 Jaw width: 15mm
- For holding wire to pull through draw plates
  - Special curved handle allowing extra pulling power and stability
  - Serrated jaws
  - Overall length 250mm
  - Jaw Width 15mm
  - Jaw Depth 40mm
  - Medium Duty

Code	Description	UOM	Price
D6239	Draw Tongs, 250mm	EACH	£10.95

**Tongs & Crucible Holders**

See Page 1004



**Beeswax Block**

See Page 1170



**Durstons Rolling Mills**

See Page 723

**Tube Cutting Jig with Sizing Gauge**

See Page 832



- Light weight and easy to use
- Made from carbon steel
- Cut production costs by making your own jump rings in gold, silver and platinum

Size: entire length 230mm  
Weight: 135 grams per set of 2

Code	Description	UOM	Price
M31885	Ø1.5mm to Ø10mm Jump Ring Making Mandrels	PACK*2	£12.95

## Jump Ring Maker



### Jump Ring Maker

Excellent for easily producing multiple jump rings, links etc, from round or oval wire. Suitable for use with the Foredom number 30 handpiece & pendant motor (as well as the Dremel equivalent) (our reference K2230CE)

#### How to use:

1. Place the preferred mandrel size into the chuck and tighten, locking the mandrel in place ready to make your coil of wire.
2. Keeping the wire pulled tight, use the handle to rotate the mandrel creating a tight coil of wire around your mandrel.
3. Remove the coil from the mandrel and place in the coil holder, twisting the nuts to press the sprung loaded top down, holding your now coiled wire firmly in place.
4. Insert your number 30 hand piece (not supplied) into the protective collar. Then attach the circular saw blade using the cutter holder attachment provided.
5. Lubricate the saw blade using our burr cut lube (B4181)
6. Cut along the slit, cutting your coil into your simple and easy to make jump rings

#### Kit contains:

- 20 mandrels, from Ø2.5 to Ø12mm (sizes carved on wooden base)
- Rotation stand and lever (can be screwed to base, screws not supplied)
- Spring loaded coil holder
- Protective hand piece collar (for no.30 hand piece, supplied separately)
- Saw cutter blade
- Attachment for saw cutter blade
- Supplied on wooden base with labelled compartments

Made in India

Code	Description	UOM	Price
J39047	Jump Ring Maker	EACH	£135.00
J40313	Saw Cutter Blade for Jump Ring Maker	EACH	£7.95



**DURSTON**  
Online Tutorials

Solder Panels,  
Strips & Syringes

See Page 52



## Jump Ring Maker, Durston



No pendant motor? No worries!

Use the excellent quality Durston mandrels and chuck holder on their own to create perfect sized jump rings every time, using your existing cutters.

- 20 mandrels, Ø2.5, 3, 3.5, 4, 4.5, 5, 5.5, 6, 6.5, 7, 7.5, 8, 8.5, 9, 9.5, 10, 10.5, 11, 11.5 and 12mm
- Increased mandrel length, each one 120mm long
- Rotation stand and lever which screws into the metal base and is taller, giving more room to work
- Durston 1318

Code	Description	UOM	Price
R48922	Chuck & Mandrels	EACH	£119.95

## Jump Ring Maker, Durston (PRO 2)



Durston Jump Ring Maker PRO 2 - The Ringer

Jump Ring Maker - Made In Great Britain by Durston - Removable from Base

Excellent for easily producing multiple jump rings, links etc, from round or oval wire. Suitable for use with the Foredom number 30 handpiece & pendant motor (as well as the Dremel equivalent) (our reference K2230CE)

#### Kit contains:

- 20 mandrels, Ø2.5, 3, 3.5, 4, 4.5, 5, 5.5, 6, 6.5, 7, 7.5, 8, 8.5, 9, 9.5, 10, 10.5, 11, 11.5 and 12mm
- Increased mandrel length, each one 120mm long
- Rotation stand and lever which screws into the metal base and is taller, giving more room to work
- Spring loaded coil holder with screws for attaching to your work bench if required
- Protective hand piece collar (for no.30 hand piece)
- Saw cutter blade and attachment, high speed steel
- Supplied on metal base, components are removable

#### How to use:

1. Place the preferred mandrel size into the chuck and tighten, locking the mandrel in place ready to make your coil of wire.
2. Keeping the wire pulled tight, use the handle to rotate the mandrel creating a tight coil of wire around your mandrel.
3. Remove the coil from the mandrel and place in the coil holder, twisting the nuts to press the sprung loaded top down, holding your now coiled wire firmly in place.
4. Insert your number 30 hand piece into the protective collar. Then attach the circular saw blade using the cutter holder attachment provided.

5. Lubricate the saw blade using our burr cut lube (B4181)

6. Cut along the slit, cutting your coil into your simple and easy to make jump rings

- Made in Great Britain
- Durston 1308

Code	Description	UOM	Price
R42922	Jump Ring Maker, Durston	EACH	£189.95
D43131	Blade for Jump Ring Tool, Durston	EACH	£9.95

## Jump Ring Maker, Italian

Jump Ring Making - Italian

Excellent for producing multiple jump rings, links etc, from round or oval wire.

Place the preferred mandrel size into the unit holder and tighten with the mushroom plastic head mounted on the unit. Lock the mandrel from the 'turning handle' side with an Allen Key (not supplied).

This unit has a sliding left and right fitting for mandrels to fit perfectly. Put the wire into the mandrel 'leading hole' and hold wire with your free hand, turn the handle round and the coil starts to form on the mandrel

- Accessory Mandrels Ref: M8349 and M8348 fit this tool
- Made from carbon steel, they are strong, durable and heavy duty
- Each mandrel is 200mm long, depending on the size of the wire you can make up to 25 jump rings (Based on 1mm gold wire)
- Each mandrel has a pilot hole for your wire
- O.M.O Italy

Size and weight: Jump Ring Manufacturing Tool

- Italian 400mm x 180mm x 130mm (F8350) - 4KG
- Round Mandrel Set for Jump Ring Manufacturing Tool length 200mm (M8348) - 4.5KG
- Oval Mandrel Set for Jump Ring Manufacturing Tool length 200mm (M8349) - 1.5KG

## Jump Ring Manufacturing Tool, Italian



Code	Description	UOM	Price
F8350	Jump Ring Manufacturing Tool, Italian	EACH	£118.95

## Round (Ø4mm to 25mm) Mandrel Set

- For jump ring and link production
- Set of 21 round mandrels in steel
- Each mandrel has a pilot hole for your wire
- Ø4mm to Ø25mm in 1mm increments
- 20cm in length
- Forming Tool Ref: F8350



**SAME DAY DISPATCH**

• Made in Italy

Code	Description	UOM	Price
M8348	Round (Ø4mm to 25mm) Mandrel Set	PACK*21	£149.95

### Oval (6x4mm to 20x15mm) Mandrel Set



- For jump ring and link production
- Set of 9 oval mandrels
- Each mandrel has a pilot hole for your wire
- 20cm in length
- Sizes 6x4, 8x6, 9x7, 10x7.5, 11x8.5, 12x9, 14x11, 16x12, 20x15mm
- Forming Tool Ref: F8350
- Made in Italy

Code	Description	UOM	Price
M8349	Oval (6x4mm to 20x15mm) Mandrel Set	PACK*9	£186.50

### Jump Ring Opening Tool

#### Jump Ring Opening Tool



- Simple & easy to use
- Twist action, jump ring opener
- Save your fingers the stress
- 3 different width slots, 0.70, 1.05 & 1.60mm

Code	Description	UOM	Price
J37137	Jump Ring Opening Tool	EACH	£1.95

## MANDRELS FOR BANGLES, BRACELETS & HOOP EARRINGS

Mandrels for making bracelets, bangles and hoop earrings

Design, manufacture and repair, bangles, bracelets, hooped earring with our large selection of tools and equipment.

In recent years the public interest in bangle and bracelet fashions has glamorously resurged, particular with the growth of the Pandora and Chamilia brands. Bangles and bracelets can come in variable shapes and sizes and we stock a wide selection of tools and equipment for all sizing, manufacturing, wholesaling and retailing needs. Take this opportunity to design and manufacture your own Churi range to capitalise on a rapidly growing industry.

We have a large selection of mandrels in oval and round shapes varying in sizes and material quality. Our Italian mandrels have been used in manufacturing for generations; they are all finished to a smooth high standard. Made from cast iron their centres are hollow making them lighter to make working with them easy. Likewise we now stock an economy range of these mandrels from India at exceptional value, again made from cast iron; hollow centred comprising a

smooth finish.

Furthermore, the wooden mandrel has also proven popular as being an inexpensive way of forming, ideal for infrequent use.

### Anticlastic Mandrel & Die Set



Mandrels - Anticlastic - With Die Set - Durston

Anticlastic forming jewellery is a craft that has been used for at least over 100 years. This method provides many ideas for jewellery artists to create fascinating and profitable works of art for their customers.

Bangle making is taken to another level with the Durston bangle anticlastic forming six piece die set. This tool gives one simple method to form bangles in various shapes.

- Anticlastic forming is a technique of metal forming whereby sheet metal is formed directly with a hammer on a surface that is curved or rounded inward, creating a bowl effect on a bracelet, bangle or ring.
- Speedy change tooling allows one to slide bangle dies on and off in seconds
- Mount onto our bench vice (code V33153) or will fit standard 4" vices. It is also recommended to use some vice jaws so that the mandrel remains perfect and mark free (code FDASJ35).
- The dies and holder are precision ground, high polished and hardened ensuring if used properly will last a life time
- Special shape Durston nylon forming hammer included
- Durston 1181
- Made in UK

The item includes:

- 1 x Durston special made convex nylon hammer
- 1 x Mounting die vice bar: Ø20mm x 200mm
- 1 x large flat round die: Ø60mm x length 55mm
- 1 x Small flat round die: Ø40mm x length 55mm
- 1 x Large shallow concave die: Ø60mm x length 55mm x concaving central point Ø50mm
- 1 x Small shallow concave die: Ø40mm x length 55mm x concaving central point Ø30mm
- 1 x Large double concave shallow die: Ø60mm x length 55mm, consisting of two concave forms:
  - Large concave width 30mm x concaving central point Ø50mm
  - Small concave width 15mm x concaving central point Ø30mm
- 1 x Small twin concave shallow die: Ø40mm x length of face 55mm, consisting of two concave forms:
  - Large Concave width 30mm x concaving central point Ø30mm
  - Small concave width 15mm x concaving central point Ø25mm

How to use:

1. Secure the mounting die vice bar into your bench vice and chose a die required for forming your shape.
2. Push the die onto the die bar holder and see how you can also turn the die a full 360°, giving a wide flexibility for forming a bangle
3. For anticlastic forming, place your metal into the concave shape and tap with the forming hammer provided, constantly around the metal. Notice now how the bangle develops a concave anticlastic shape
4. With your plain dies, place the metal over the chosen die and tap evenly so the piece wraps its self over die. This will give you a perfect round bangle form.

Code	Description	UOM	Price
D35760	Bangle Forming Anticlastic Mandrel & Die Set	EACH	£149.95

### Oval, Steel



Mandrels - Oval - Steel

- For bangle / bracelet forming and reshaping
- O.M.O. Italy
- \* Indian made may have some small surface imperfections that does not detract from use

Code	Description	UOM	Price
M6546	25 x 35mm to 45 x 55mm (height 300mm) O.M.O. Italy	EACH	£79.95
M31942	30 x 35mm to 60 x 70mm (height 380mm)*	EACH	£12.40
M36252	32 x 40mm to 65 x 70mm (height 310mm)*	EACH	£17.95
M37845	37 x 40mm to 55 x 65mm (height 230mm) with Tang*	EACH	£21.95
M6547	45 x 55mm to 65 x 75mm (height 300mm) O.M.O. Italy	EACH	£79.95
M6548	65 x 75mm to 85 x 95mm (height 300mm) O.M.O. Italy	EACH	£99.95

### Oval, Wooden



Mandrels - Oval - Wooden

Ideal for repair purposes, re-forming etc

- 30 x 35mm to 60 x 65mm
- Height 380mm

Code	Description	UOM	Price
M36251	30 x 35mm to 60 x 65mm Oval Mandrel	EACH	£12.95





Round, Steel



Mandrels - Round - Steel

- For bangle/bracelet forming and reshaping
- O.M.O Italy
- \* Indian made may have some small surface imperfections that does not detract from use

Code	Description	UOM	Price
M6543	Ø25 to Ø50mm (height 300mm) O.M.O Italy	EACH	£40.95
M36485	Ø35 to Ø60mm (height 300mm)*	EACH	£18.95
M37844	Ø35 to Ø65mm (height 230mm) with Tang*	EACH	£18.95
M31941	Ø35 to Ø75mm (height 380mm)*	EACH	£19.95
M6544	Ø40 to Ø70mm (height 300mm) O.M.O Italy	EACH	£56.95
M6545	Ø50 to Ø90mm (height 380mm) O.M.O Italy	EACH	£69.95

Round, Steel Stepped



Mandrels - Round - Steel - Stepped

- 4 Steps: Ø49, 54, 59 & 64mm
- With Tang for securing in vice: 45 x 45mm
- Overall length 230mm
- Steel

Code	Description	UOM	Price
M37846	Round Stepped with Tang	EACH	£17.95

Round, Steel (for Hoop Earrings)



Mandrels - Hoop Earring - Steel

- For making hoop earrings from Ø10 to Ø50mm
- Also use for Bangles & Bracelets)
- Height 300mm

Code	Description	UOM	Price
M31939	Ø10 to Ø50mm (height 300mm)	EACH	£12.50

Round, Wooden



Mandrels - Round - Wooden

- This inexpensive wooden mandrel is made from good quality boxwood
- It is lightweight and easy to handle when making and forming bangles
- Different sizes available
- See website "more info" for further specification

Code	Description	UOM	Price
M20876	Ø35 to Ø50mm (height 380mm) Mandrel	EACH	£6.95
M47012	Ø35 to Ø65mm (Height 230mm) Mandrel	EACH	£8.95

Round, Wooden Stepped



Mandrels - Round - Wooden - Stepped

- 4 Steps: Ø50, 57, 63 & 70mm
- With Tang for securing in vice: 45 x 45mm
- Overall length 230mm
- Wooden

Code	Description	UOM	Price
M37847	Round Stepped with Tang	EACH	£15.95

Round, Wooden with Handle



Mandrels - Round - Wooden - With Handle

- This inexpensive wooden mandrel with handle is made from good quality boxwood
- Handle makes it extremely easy to use and manoeuvre to your needs
- It is lightweight and easy to use when making and forming bangles
- Ø40 to Ø70mm
- Height 230mm
- Weight 430g

Code	Description	UOM	Price
M37131	Ø40 to Ø70mm (height 230mm) Mandrel with Handle	EACH	£12.90

Mandrel Holder



- Mandrel holder for bangle/bracelet mandrels with tang
- Plates screws to any work bench
- Holder is removable, slots & fixes onto the plate
- For use with mandrels M37846, M37844 & M37847
- Enables hands free working with excellent stability
- Holder hole size: 50 x 40 x 30 (width x length x depth)
- Plate size: 105 x 40 x 10 (width x length x depth)

Code	Description	UOM	Price
M47013	Mandrel Holder for Bracelet/Bangle Mandrels	EACH	£24.50



MANDRELS & TRIBLETS FOR RINGS



We supply a large selection of Mandrels for Rings and Triblets with lots of variant shapes and sizes. All of our range are ground with precision and are made of hardened best quality steel. We also supply a wide range of mallets and hammers to use with these tools. Moreover, we stock a large selection of ring sticks and gauges, please see links below.

Popular ways that our customer's use Mandrels for Rings and Triblets when repairing or manufacturing...

Repairing:

Reshaping wedding bands/ring shanks to its original shape whether that be round, square, oval etc. When a customer brings a ring to repair most often it has been distorted in shape due to everyday wear. Depending on the size and shape of the ring place it on the tapered Triblet that matches the shape. Ideally use a mallet to tap the ring shank as this will not mark or indent. We supply a large selection of Mandrels for Rings and Triblets with lots of variant shapes and sizes. All of our range are ground with precision and are made of hardened best quality steel. We also supply a wide range of mallets and hammers to use with these tools. Moreover, we stock a large selection of ring sticks and gauges, please see links below.

Popular ways that our customer's use Mandrels for Rings and Triblets when repairing or manufacturing...

Manufacturing:

When making a ring first decide which shape you would like the ring to be. Round is most common but other shapes sometimes can be more desirable for varying a collection and favourable for selling.

Sizing too is important; measure the customer's finger size in advance by using a ring gauge and ring stick to determine the size, many Triblets, Ringsticks and Guages in our range have sizes on already. There are many size systems throughout the world so please use a ring conversion chart (see PDF link below). Ring bands can be made in many different shapes and forms using rolling mills, a variety of shapes can be formed using a rolling mill, draw plates, swage blocks etc. To determine the size of the band it is useful to have a ring stick with millimetre, circumference and diameter sizes (code R31920). For example, place your ring on the triblet and size reads "W" UK size, the band length equates to 65mm in length.

Once you have made your band and annealed it, use Half Round Pliers (P4784) to start forming into a circular shape. Place your band on the Triblet shape you would like to make and tap it

with a hammer or mallet; hold the Triblet firm and place the end on bench peg for leverage. Keep turning the triblet around in a circular motion and you will have your ring/band formed. Using a hammer first makes it easier to bend the band and then finish with a mallet to tighten the shape around the Triblet.

Triblets are widely used to make sheet metal, bezels, collets and mounts. Mounts are metal bands that surround the stone(s). We also have a range of smaller Triblets which are used to make large to small jump rings i

### Triblet Holder

Triblet Holders

- Cast iron or steel base for your triblet
- Supports your triblet whilst you hammer, form or solder
- Can be screwed/bolted to bench
- Durston model had 3 steps allowing you to work at different angles & heights

See website "more info" for further specification

### Triblet Holder



- Steel base for your triblet
- Black powder coated
- Made in India

Dimensions:  
• 340 x 50 x 90mm (L x W x H)  
• 3.5Kg

Code	Description	UOM	Price
M47014	Triblet Holder	EACH	£16.95

### Triblet Holder, Durston



- Cast iron base for your triblet
- 3 steps allowing you to work at different angles & heights
- Durston 1531
- Made in UK

Dimensions:  
• 293 x 70 x 75mm  
• 2.7Kg

Code	Description	UOM	Price
T45655	Triblet Holder, Durston	EACH	£34.95

### Anticlastic (Sinusidal) Triblets



Triblets - Anticlastic (Sinusidal)

Anticlastic forming refers to the shaping of an object

where the dominant axis moves in opposite directions; a familiar example of this is a potato chip or horse saddle.

- Anticlastic, sinusidal mandrel
- Wheatsheaf (Made in UK) or Cousins

Code	Description	UOM	Price
S48847	220mm, Ø6 to Ø12mm, Cousins	EACH	£18.95
S33349	240mm, Ø4 to Ø18mm, Wheatsheaf	EACH	£99.95
S48848	400mm, Ø10 to Ø25mm, Cousins	EACH	£27.95

### Oval Triblets



Triblets - Oval

Oval triblets are perfect for making rings for both fingers and toes

- Length x working sizes
- Length excludes handle
- Wheatsheaf UK, O.M.O Italy or unbranded

Item T42893 supplied with a screw in tang for holding in a vice

Code	Description	UOM	Price
T4248	200mm (2.4 x 4mm to 11 x 12.5mm) Wheatsheaf	EACH	£51.95
T7883	230mm (8x12mm to 26x34mm) O.M.O Italy	EACH	£39.95
T42893	230mm (11 x 13 to 23 x 25mm) with Tang	EACH	£11.95

### Rectangle Triblets



- Hard Chrome plated
- With screw in tang for holding in a vice
- Length x working sizes
- Length excludes handle
- Made in India

Code	Description	UOM	Price
T42895	230mm (7 x 11 to 16 x 20mm) with Tang	EACH	£14.95

### Ring Bezel Mandrel Triblets



Triblets - Ring Bezels

Form bezels of various shapes and sizes with these specially-shaped mandrels

- Very popular for jewellers, silversmiths, light engineers, model makers and those in arts and crafts

- Can be used on a whole range of metals such as gold, silver, platinum, titanium, palladium, copper, and brass
- Wide variety of shapes available
- Also used to make jump rings for jewellery making and repair
- Machined from carbon quality steel
- Very good to make baby and toe rings etc.

Shapes:

- Oval
- Square
- Hexagonal
- Rectangular
- Triangular
- Round
- Star

Length: 280mm

Code	Description	UOM	Price
M20873C	Hexagonal (4.5x4.5mm to 11x11mm) Triblet	EACH	£5.95
M20873A	Oval (5.50x4.8mm to 12x10mm) Triblet	EACH	£5.95
M20873D	Rectangular (6x4mm to 100x8mm) Triblet	EACH	£5.95
M20873F	Round (5mm to 12mm) Triblet	EACH	£5.95
M20873B	Square (4x4mm to 9x9mm) Triblet	EACH	£5.95
M31872	Star (6.5mm to 12mm) Triblet	EACH	£7.95
M20873E	Triangular (5x5 to 11x11x11) Triblet	EACH	£5.95

### Round (Plain) Triblets



Triblets - Round - Plain

- Most popular shape throughout the world
- Length excludes handle
- Durston, Wheatsheaf UK or Cousins
- Stainless steel

Dimensions:

- Overall length, working sizes

Code	Description	UOM	Price
T4220	160mm, Ø5 to Ø12.5mm, Wheatsheaf	EACH	£14.95
T5177	200mm, Ø8 to Ø19mm, Cousins	EACH	£13.50
M31943	200mm, Ø12 to Ø24mm, Cousins	EACH	£9.95
T5178	250mm, Ø11 to Ø25mm, Wheatsheaf	EACH	£20.25
T5179	320mm, Ø11 to Ø25mm, Cousins	EACH	£22.95
T35267	320mm, Ø10 to Ø28mm, Cousins (Recessed Handle)	EACH	£15.95
T45654	365mm, Ø5 to Ø20mm, Durston	EACH	£22.50
T45653	365mm, Ø10 to Ø25mm, Durston	EACH	£21.95
T45652	410mm, Ø10 to Ø28mm, Durston	EACH	£24.95

### Round (Plain Wooden) Triblets



Triblets - Round - Plain - Wooden

An inexpensive wooden triblet made from good quality boxwood. It is lightweight and easy to handle when making and forming rings.

- 205mm Overall length
- Ø12 to Ø24mm
- Wooden

Code	Description	UOM	Price
R37135	Wooden Ring Triblet	EACH	£1.95

## Round (Graduated without Lines) Triblets



Triblets - Round - Graduated - No Lines

- Accurately form / shape with these marked Triblets
- No lines, only letters and numbers so you will not get line marks on the back of the ring
- Length excludes handle
- Durston, Wheatsheaf UK or Cousins

Dimensions:

- Overall length (working sizes)

Code	Description	UOM	Price
R40301	230mm, A to Z +6, Cousins	EACH	£11.95
M31940	250mm, A to Z +3, Cousins	EACH	£13.95
R35268	300mm, A to Z +6, Cousins	EACH	£17.95
T4218	320mm, A to Z +6, Wheatsheaf	EACH	£29.95
R45656	360mm, A to Z +6, Durston	EACH	£29.95
T4205	400mm, A to Z +6, Wheatsheaf	EACH	£31.85

## Round (Graduated with Lines) Triblets



Triblets - Round - Graduated - With Lines

- Accurately form/shape with these marked lined triblets
- Length excludes handle
- Lined shaft for accurate sizing
- Stainless steel
- Wheatsheaf UK

Special:

- Triblet T32856 Yes we have a triblet that measures A-Z+10! This triblet will cover for almost every eventuality in finger sizing, to prevent any loss of trade. Make customers aware you accommodate for larger finger sizes, boost your reputation and your profits, be prepared to make anything.

Dimensions:

- Overall length (working sizes)

Code	Description	UOM	Price
T4213	200mm, A to Z, Wheatsheaf	EACH	£24.95
T4215	250mm, A to Z+6, Wheatsheaf	EACH	£25.25
T32856	250mm, A to Z+10, Wheatsheaf	EACH	£37.95
T4210	250mm, A to Z+6 (plus ISO 41-76) Wheatsheaf	EACH	£34.95

## Round (Graduated with Lines, Wooden) Triblets



Triblets - Round - Graduated - With Lines

An inexpensive wooden triblet made from good quality boxwood. It is lightweight and easy to handle when making and forming rings and will not leave marks as easily as a steel triblet would.

- Accurately form & shape with this lined triblet. You may get light lines on the back of your rings, finishing is required
- Length excludes handle
- Lined Shaft for accurate sizing
- Wooden

Dimensions:

- Overall length (working sizes)

Code	Description	UOM	Price
W39059	215mm (Ø12mm to Ø24mm), Cousins	EACH	£4.50

## Round (with Groove or Flat) Triblets



Triblets - Round - With Groove - With Flat

- Groove, form or re-shape your ring
- The groove is so a gemstone with a shallow or deep culet will fit over this triblet and the stone will not get damaged
- Flat is to form & shape signet rings
- Length excludes handle
- Stainless steel
- Wheatsheaf UK or Cousins

Dimensions:

- Overall length (working sizes)

Code	Description	UOM	Price
M31944	220mm (Ø12mm to Ø24mm) with Groove, Cousins	EACH	£12.50
T4214	250mm (Ø11mm to Ø25mm) with Flat, Wheatsheaf	EACH	£33.45
T4216	250mm (Ø12mm to Ø25mm) with Groove, Wheatsheaf	EACH	£33.45
T1721	320mm (Ø9mm to Ø25mm) with Groove, Wheatsheaf	EACH	£33.45

## Square Triblets



Triblets - Square

Form/shape a square ring, eye catching for customers or make a square collets for your stone settings

- Length excludes handle
- Stainless steel
- O.M.O Italy or India

Dimensions:

- Overall length (working sizes)

Code	Description	UOM	Price
T7884	200mm (4 x 4mm to 10 x 10mm) O.M.O Italy	EACH	£27.95
T42894	230mm (6.5 x 6.5 to 18 x 18mm) with Tang	EACH	£11.95
T7882	250mm (10 x 10mm to 25 x 25mm) O.M.O Italy	EACH	£39.95

## Teardrop Triblets



Triblets - Teardrop

- For making a collet for all pear shaped stones such as diamonds & coloured stones, particularly cabochons
- Length excludes handle
- Stainless steel
- O.M.O Italy

Dimensions:

- Overall length (working sizes)

Code	Description	UOM	Price
T6538	170mm (5mm to 15mm) O.M.O Italy	EACH	£57.95
T6539	230mm (10mm to 25mm) O.M.O Italy	EACH	£63.95

## Triangle Triblets



- Hard Chrome plated
- With screw in tang for holding in a vice
- Length x working sizes
- Length excludes handle
- Made in India

Code	Description	UOM	Price
T42896	230mm (11 x 11 x 11 to 22 x 22 x 22mm)	EACH	£14.95

## NECKLACE BUSTS

- Our necklace busts are an essential tool for shaping necklaces easily and accurately.
- Beautifully constructed of polished cast iron.
- Use to work metals or to form wax.
- Guarantees that your necklaces will be of the proper length and fit every time.
- By using this necklace mandrel, you can hammer, forge, or work with wax to design to create natural draping necklaces.
- Made of highly polished cast iron, these "Iron Bust's" also make attractive counter or window displays.

### Necklace Bust, Indian

- 2.5kg
- Cast Iron
- Chrome Plated
- 185mm at shoulders
- Ø90mm at neck
- 120mm Overall height



Code	Description	UOM	Price
N35100	Small (185 x 120mm - 2.5kg) Bust	EACH	£17.95

### Necklace Bust, Italian



Quality Polished ITALIAN Cast iron bust for forming neck pieces

- Polished cast iron.
- Use to work metals or to form wax.
- Guarantees that your necklaces will be of the proper length and fit every time.
- By using this necklace mandrel, you can hammer, forge, or work with wax to design to create natural draping necklaces.
- Made of highly polished cast iron, these "Iron Bust's" also make attractive counter or window displays.
- O.M.O Italy

Dimensions:

- Shoulder width x height - weight

PRICE PROMISE GUARANTEE

• See additional information for full specification

Code	Description	UOM	Price
B6549	Small (210 x 110mm - 3.2kg) Bust	EACH	£119.95
B6550	Large (250 x 175mm - 8kg) Bust	EACH	£189.95

## RIVETING & PIERCING

### Riveting & Piercing Tool



Riveting & Piercing Tool

Create metal connections and joints without a torch.

The basic idea of a rivet is that a small tube-shaped piece of metal is inserted through holes in pieces of metal sheet (a pendant and its added on décor for example) and then the tube-shaped metal is flattened on both ends to secure the metal sheet together.

- This innovative riveting system is intended to pierce and set semi-tubular rivets
- Semi-tubular rivets have a hard head that creates a finished look, and a tubular end that is set by a flaring method to create a secure, clean, and constant connection
- The tool features a piercing tool on one end that creates the hole to accommodate the rivet. The other end is a flaring tool which precisely and cleanly sets the rivet
- No need for a hammer, brilliant for delicate work
- Piercing can also be used to create perfect spherical holes for threading (for pendants/decorations)
- The tool is machined from heat treated tool steel, unlike many hand tools on the market which are made from softer metals and then case hardened
- This is what gives our tool the strength and precision to perform as well as it does, allowing you to easily pierce through material up to 2mm
- Used for metal sheet .22 gauge and under
- Can be used on sheet metal, leather etc.

Dimensions:

- 75 x 40 x 10mm
- Hole piercing diameter: Ø1.50mm
- Maximum sheet depth: 25mm
- Largest size rivet: Ø2.90mm
- 125g

Code	Description	UOM	Price
R37130	Riveting & Piercing Tool	EACH	£6.75

## SPOON STAKE

### Spoon Stake (For Making Spoons)

Designing and making handmade spoons is one of the most ancient art forms a silversmith/jewellery artist has performed for many century's.

Spoons are suitable for many occasions and customers will often present them for special occasions such as christenings, shooting spoons, apostle as well as your basic tea, coffee or soup spoon.

If you have ever wanted to make spoons with your own designs, take a look at our singular or set of spoon stakes.

### Spoon Stake (For Making Spoons)



- Traditional English Spoon Stake
- Head size: 50 x31mm
- Overall height 75mm
- Highly polished
- Cast iron

Code	Description	UOM	Price
S4254	Spoon Stake (For Making Spoons)	EACH	£39.55

### Set of 4 Spoon Stakes with Wooden Stand



Sizes of top surface:

- Small 32mm x 23mm x 8mm
- Medium 39mm x 26mm x 11mm
- Large 50mm x 33mm x 11mm
- Extra large 65mm x 40mm x 13mm

Weight : 700grams

Code	Description	UOM	Price
S34922	Set of 4 Spoon Stakes with Wooden Stand	PACK*4	£9.95

## GEMMOLOGICAL INSTRUMENTS



### Gemmological Instruments

Become a Gemstone Dealer, plus enjoy learning with our selection of tools for gemstone identification, whether you're buying or selling, or simply have an interest in to the world of Gemstones.

The key to avoiding costly mistakes and recognizing profitable opportunities, is to know what to look out for with a hands on approach.

Our range for Gem Identification Tools equipment and books will help you:

- Open your eyes to the types of treatments, imitations, synthetics, look-alikes and fakes in the gem market today.
- Learn how to tell the difference between them.

Quickly spot:

- Synthetics, including emeralds and diamonds
- Filed diamonds

- Diffused "blue" sapphires and "red" rubies
- High pressure/high temperature (H P H T) – treated diamonds
- Discover how to identify new gems such as "mandarin" garnet red "emerald", and North Carolina's chromium-rich emeralds
- Know when to seek help from a professional gemmologist or lab
- Become more professional in your business or hobby

Please note:

Gemmological instruments tools are designed to save you time and effort. It is your responsibility to understand what the Gemmological instruments response signifies. Our range is practically more useful in telling you what a stone is NOT, then what it is. And can be helpful in narrowing down possible identifications. With experience you will know when to seek help from a professional gemmologist lab.

### Chelsea Filter

#### Chelsea Filter



Assists stone sorting and gem identification. Includes instructions and guide notes.

The Chelsea Filter (emerald filter) is a pocket-sized colour filter.

It is used primarily to spot fakes mixed in with natural stones in coloured stone parcels and jewellery, and to differentiate emeralds, sapphires, aquamarines and natural green jadeite from manufactured stones.

See Website full product information.

Code	Description	UOM	Price
E9451	Chelsea Filter	EACH	£24.85

### Diffraction Spectroscope

#### Diffraction Spectroscope



For pure transparent (non opaque) stones. Each type of stone has its own spectrum colour diagnostic. Similar to the prism spectroscope but works by diffracting white light to give non prismatic perspective.

It may be used to test transparent gem materials including rough and broken pieces, fashioned pieces, strings of beads, gems set in jewellery, ornaments and carvings.

See Website full product information.

Code	Description	UOM	Price
E9518	Diffraction Spectroscope	EACH	£53.95

## Jadeite Filter

### Jadeite Filter



Used for differentiating between natural and dyed green and lavender jade.

- Very effective tool in the use of separating red, blue and green stone from others that might look similar in comparison.
- Extremely useful in detecting certain dyes treated on gemstones.

See Website full product information.

Code	Description	UOM	Price
E33835	Jadeite Filter	EACH	£24.50

## London Dichroscope

### London Dichroscope



Incorporates two polarizing sheets mounted at right angles to each other allowing the London Dichroscope necessity to samples rays from two different areas of the same stone.

Examples are views of a Tourmaline/ruby gemstone with a London Dichroscope with a back light. With the same ray of light entering the gemstone both sides should be the same colour under the filter.

See Website full product information.

Code	Description	UOM	Price
E9519	London Dichroscope	EACH	£33.95

## Prism Spectroscope

### Prism Spectroscope



View when held to natural light

Used to test less pure transparent (opaque) gem materials including rough and broken pieces, fashioned pieces, strings of beads, gems set in jewellery, ornaments and carvings.

Prism spectroscope (based on dispersion) is a tool for examining which parts of white light are absorbed by a gemstone (as well as by other materials).

See Website full product information.

Code	Description	UOM	Price
E9517	Prism Spectroscope	EACH	£49.95

## Prism Spectroscope with Focus Option

### Prism Spectroscope with Focus Option



View when held to natural light

Used to test less pure transparent (opaque) gem materials including rough and broken pieces, fashioned pieces, strings of beads, gems set in jewellery, ornaments and carvings.

The focus option allows you to focus the lines better.

Prism spectroscope (based on dispersion) is a tool for examining which parts of white light are absorbed by a gemstone (as well as by other materials).

See Website full product information.

Code	Description	UOM	Price
E33808	Prism Spectroscope with Focus Option	EACH	£89.95

## UV Long Wave Pen



- An instrument which detects the fluorescent reaction of diamond
- Used to judge the colour grading & positioning of stones
- Distinguishes stones according to the distinctive colour emitted by the long wave UV light
- Applies to gems such as natural ruby from Myanmar, opal, amber synthetic ruby, spinel and sapphire, YAG etc
- Many natural diamonds emit a distinctive glowing blue colour under UV light and other coloured diamonds give a particular light

Specifications

- Ø20mm
- 100mm long

- Lightweight & portable
- Requires 1 x AA batteries, reference MN15006 (not included)

Code	Description	UOM	Price
U40268	Ultra Violet Long Wave Pen, A*F Swiss	EACH	£29.95

# GRAVERS, SCORPERS, SCRAPERS & DEBURRING

Tools for engraving, setting, chasing, sculpting, etc are inexpensive compared with the cost of essential tooling to practice other crafts. One is able to buy the essentials for a lifetime of manufacturing, leaving only the expense of replenishing consumables.

At Cousins Material House Ltd we distribute a full range of Swiss Vallorbe gravers and accessories for a wide variety of modern day workshop applications for manufacturing, repairing, craftwork, hobbyists and work in the fine arts.

With various industries demanding the highest quality tools, Vallorbe gravers have been the forefront market leader in this field. Used by industry experts all over the world on millions of pieces there is very little the Vallorbe Graver has not touched.

Gravers come in various shapes, sizes and metal qualities.

Metal types:

- **Tools Steel (WS)** the standard graver, keeps a tough sharp edge maintaining hours of production usage.
- **High Speed Steel (HSS)** this tougher graver keeps a sharp edge for a considerably longer time than normal tool steel gravers (WS).

More graver info:

Gravers can be used on a whole variety of metals or materials including gold, silver, platinum, palladium, titanium, copper, brass, bronze, pewter, gilding metal, steel, ivory, bone, wood, plastics and aluminium.

All gravers have markings from the manufacturer which indicates the size and metal quality. HSS gravers always have a yellow paint mark on the tang of the graver; this identifies the mounting point for the handle. Additionally measure the width of the graver and compare with the graver chart below, to determine the size.

Graver handles come in different shapes and sizes, it is advisable to replace the handle with the graver to ensure optimum grip between handle and graver.

Preparing a graver:

A graver tool has to be of a certain length to suit the hand of the user. Held in working position, the end of the tool should project half to three-quarters of an inch beyond the thumb.

A graver, when brought, will be too long and will have to be shortened. If only a small reduction is required a small piece can be broken off the tang before the handle is fitted. The tang is not as hard as the rest of the tool and the broken end should be filed or grinded to a point so that it can be easily inserted into the handle.

If a graver has to be shortened considerably, the end will have to be ground off by using a double bench grinder (code B33154) and care must be taken not to over-heat the tool

and "draw the temper" – that is, cause to become too soft for use as a cutting graver. During grinding the graver will become very hot, intermittently dip the graver into water to ensure the steel doesn't overheat and become brittle. Continue this process until the shape forms a point ready to fit into a handle. One can also use a sharpening stone to shape gravers according to individual specification.

## Deburring Tool



Deburring tool with pocket clip

- Fast efficient and economical solution to remove Burrs which remains at the edges of components after cutting or machining and to take sharp edges off metal sheet
- For the jeweller, silversmith, arts craft, contemporary jeweller, model makers and light engineers
- The fine sharp blade the edge after any cutting shearing or punching process
- This tool is ideal for working with wax or metals
- Rotating blade enables you to smooth circular inner & outer edges

Size & Weight:

- Length 140mm
- Diameter Ø8mm
- Weight 20 grams

Code	Description	UOM	Price
B31879	Deburring Tool with Pocket Clip	EACH	£3.25

## Graver Sharpener Holders

### Graver Sharpener

Handy graver sharpener with metal roller, aluminium body and two brass positioning screws for correct angles.

- Small and inexpensive this graver sharpener can be used with all of our range of Swiss Vallorbe gravers (please note: 6mm Square HSS Graver, code 0501Hss600 will not fit in this tool)
- Gravers are placed in either of two angled tear drop openings and should be then rolled over the oilstone to sharpen and shape.
- Consistently achieve the perfect angle when sharpening.

Size: 45mm x 35mm 5mm

Weight: 30g

Code	Description	UOM	Price
G9475	Graver Sharpener	EACH	£2.75

### Graver Sharpener, Bergeon Swiss

• Bergeon 2462  
A high precision graver sharpener, made from steel, from Switzerland's Bergeon and the best of its kind.

• Ideal to use with a sharpening stone on a base (code S4868 or S31323);

• Comprises a smooth roller feet manoeuvre.

• The graver sharpener allows the angle of the graver



to be adjusted to the appropriate angle and locks the tool for consistent sharpening and polishing

- Will hold a square and lozenge graver from 1.25mm.

Size: up to 4mm Gravers

Weight: 35g

Code	Description	UOM	Price
G0751	Graver Sharpener, Bergeon Swiss	EACH	£73.95

### Graver Sharpener, Crocker Style



Engraving, stone setting and chasing certainly has its skill, as techniques and experience that you have learnt over time produces high quality workmanship.

A Crocker style Graver Sharpener is a traditional tool used for decades by some of the greatest crafts people.

Set your angle precisely with consistency while grinding and sharpening your hand engraver tools. It is easy to use; just simply place it in the angle holder sleeve. Rest the table base bar on your bench and moving left to right grind/sharpen your graver.

- Choose from two angles to quickly achieve the accurate hone and sharp edge you need for professional engraving results.
- Index adjustment for both angle and pitch. Use with sharpening stones of your choice.
- Please note graver and sharpening stone not supplied

Code	Description	UOM	Price
G34925	Graver Sharpener, Crocker Style	EACH	£16.95

## Gravers, Bergeon Specialist

### Bergeon 2930 Staff Graver



- Bergeon 2930
- Widia
- For left or right handed turning
- 2.00mm square section
- Handle Diameter Ø5.0mm
- Overall Length 135mm
- Weight 25g

Excellent high quality, Bergeon Swiss, staff gravers; will cut the hardest of metals without quick deterioration of the edge.

- Mounted on a metal knurled handle for the ultimate compatibility.
- Plastic cap protector included.
- This hard steel graver will re-sharpen on a Diamond Lap Stone (code D33152)

Code	Description	UOM	Price
G0749	Bergeon 2930 Staff Graver	EACH	£34.50

### Bergeon 2931 Winding Stem Graver



- Bergeon 2931
- Widia
- 0.50 x 6.00mm section
- Handle Diameter Ø8.0mm
- Overall Length 135mm
- Weight 25g

Excellent high quality, Bergeon Swiss, stem gravers will cut the hardest of metals without quick deterioration of the edge.

- Mounted on a metal knurled handle for the ultimate compatibility
- Plastic cap protector included
- This hard steel graver will re-sharpen on a Diamond Lap Stone (code D33152)

Code	Description	UOM	Price
G0750	Bergeon 2931 Winding Stem Graver	EACH	£63.50

## Gravers



Gravers

- Pack\*2
- Ideal for watch makers & jewellers
- Great starter gravers
- Stainless steel

Code	Description	UOM	Price
G39426	Knife & Chisel	PACK*2	£1.95
G39427	Square & Diamond	PACK*2	£2.15

## Gravers, Set



Graver set

- Set of 6
- Most popular flat edge shape
- With wooden handles
- Stainless steel

Set contains:

- Flat edge, 0.10mm
- Flat edge, 0.20mm x 2
- Flat edge, 0.30mm
- Flat edge, 0.40mm
- Flat edge, 0.50mm

Dimensions are approx.

Code	Description	UOM	Price
G39425	Gravers Set	PACK*6	£10.25

PRICE PROMISE GUARANTEE

## Graver, Flat Edge



Flat Edge - Gravers - Vallorbe Swiss (0401) or Unbranded

The Flat Edge Graver is used to cut out parallel curves and lines when engraving, chasing, decorating or sculpting. A professional stone setter will always 'bright cut'\* prior to setting an open back type setting; such as between peg clusters or along the channel before setting the stone(s) into the mount. The now reflective base will act as a mirror to enhance the stones sparkle. Additionally, jewellers often rhodium plate over the ring mount after the 'bright cut' process especially when setting diamonds.

\*Bright cut – the action of cutting the surface of the area where the stone is to be set, in order to enhance the stone.

- Wider, flat gravers such as No.24 create a unique finish by 'rocking' the graver from left to right while pulling the graver back creates an old fashioned and impressive textured effect on the surface.
- Furthermore, illusion settings enhance the appearance of small stones, making them seem bigger. By cutting facets on the illusion plate (around the stone) with a flat scorpor or a square graver, the metal will catch and reflect light, adding to the sparkle of the stone.
- Tool Steel (WS) = Length 80mm
- High Speed Steel (HSS) = Length 65mm
- Vallorbe Swiss or Unbranded

Code	Description	UOM	Price
G45792	A = 0.20mm (No.2) HSS	EACH	£5.50
0401HSS2	A = 0.20mm (No.2) HSS, Vallorbe	EACH	£12.25
0401WS2	A = 0.20mm (No.2) WS, Vallorbe	EACH	£9.95
G45793	A = 0.40mm (No.4) HSS	EACH	£5.50
0401HSS4	A = 0.40mm (No.4) HSS, Vallorbe	EACH	£12.25
0401WS4	A = 0.40mm (No.4) WS, Vallorbe	EACH	£9.95
G45794	A = 0.60mm (No.6) HSS	EACH	£5.50
0401HSS6	A = 0.60mm (No.6) HSS, Vallorbe	EACH	£12.60
0401WS6	A = 0.60mm (No.6) WS, Vallorbe	EACH	£9.95
G45795	A = 0.80mm (No.8) HSS	EACH	£5.50
0401HSS8	A = 0.80mm (No.8) HSS, Vallorbe	EACH	£12.60
0401WS8	A = 0.80mm (No.8) WS, Vallorbe	EACH	£9.95
G45796	A = 1.00mm (No.10) HSS	EACH	£5.50
0401HSS10	A = 1.00mm (No.10) HSS, Vallorbe	EACH	£15.75
0401WS10	A = 1.00mm (No.10) WS, Vallorbe	EACH	£9.95
0401HSS12	A = 1.20mm (No.12) HSS, Vallorbe	EACH	£12.95
G45797	A = 1.20mm (No.12) HSS	EACH	£5.50
0401WS12	A = 1.20mm (No.12) WS, Vallorbe	EACH	£9.95
G45798	A = 1.40mm (No.14) HSS	EACH	£5.50
0401HSS14	A = 1.40mm (No.14) HSS, Vallorbe	EACH	£13.45
0401WS14	A = 1.40mm (No.14) WS, Vallorbe	EACH	£9.95
G45799	A = 1.60mm (No.16) HSS	EACH	£5.50
0401HSS16	A = 1.60mm (No.16) HSS, Vallorbe	EACH	£13.45
0401WS16	A = 1.60mm (No.16) WS, Vallorbe	EACH	£9.95
G45800	A = 1.80mm (No.18) HSS	EACH	£5.50
0401HSS18	A = 1.80mm (No.18) HSS, Vallorbe	EACH	£14.00
0401WS18	A = 1.80mm (No.18) WS, Vallorbe	EACH	£9.95
0401HSS20	A = 2.00mm (No.20) HSS, Vallorbe	EACH	£14.70
0401WS20	A = 2.00mm (No.20) WS, Vallorbe	EACH	£9.95
0401HSS24	A = 2.40mm (No.24) HSS, Vallorbe	EACH	£15.40
0401WS24	A = 2.40mm (No.24) WS, Vallorbe	EACH	£9.95

## Graver, Knife



Knife Edge - Gravers - Vallorbe Swiss (0406) or Unbranded

Comprised of a knife edge with straight sides, this graver is primarily used to cut excess metal away from stone settings, and when applicable, the metal between

stones in a row or cluster. The appropriate size relates to the spacing of the stone(s), the amount of metal to be removed and the size of the gemstone.

- Tool Steel (WS) = Length 80mm
- High Speed Steel (HSS)
- Vallorbe Swiss or Unbranded

Code	Description	UOM	Price
G45816	A = 1.16mm HSS	EACH	£8.75
G45817	A = 1.24mm HSS	EACH	£8.75
G45818	A = 1.35mm HSS	EACH	£8.75
G45819	A = 1.45mm HSS	EACH	£8.75
G45820	A = 1.50mm HSS	EACH	£8.75
0406WS18	A = 1.80mm WS, Vallorbe	EACH	£12.25
0406WS20	A = 2.00mm WS, Vallorbe	EACH	£12.50
0406WS22	A = 2.20mm WS, Vallorbe	EACH	£12.65
0406WS24	A = 2.40mm WS, Vallorbe	EACH	£13.15
0406WS26	A = 2.60mm WS, Vallorbe	EACH	£13.35
0406WS32	A = 3.20mm WS, Vallorbe	EACH	£15.50

## Graver, Lozenge



Lozenge - Gravers - Vallorbe Swiss (0502)

This graver cuts out a unique diamond shape, like the Square Graver, it will cut out star shapes into metal and also raises grains to secure the stone and to enhance the look of the stone (Bright cut).

\*Bright cut – the action of cutting the surface of the area where the stone is to be set, in order to enhance the stone.

- Cut out parallel curves and lines when you are engraving, chasing, decorating or sculpting.
- For cutting and turning balance staffs in a watch and clock.
- Tool Steel (WS) = Length 110mm
- Vallorbe Swiss

Code	Description	UOM	Price
0502WS150	A = 1.50mm, WS	EACH	£7.90
0502WS175	A = 1.75mm, WS	EACH	£7.50
0502WS200	A = 2.00mm, WS	EACH	£6.65
0502WS225	A = 2.25mm, WS	EACH	£6.65
0502WS250	A = 2.50mm, WS	EACH	£6.65
0502WS300	A = 3.00mm, WS	EACH	£8.15

## Graver, Onglette or Spitstick



Onglette or Spitstick - Gravers - Vallorbe Swiss or Unbranded

Comprised of a knife edge and curved sides, this graver is primarily used to cut excess metal away from stone settings, and when applicable, the metal between stones in a row or cluster. The appropriate size relates to the spacing of the stone(s), the amount of metal to be removed and the size of the gemstone.

- Tool Steel (WS) = Length 80mm
- High Speed Steel (HSS)
- Vallorbe Swiss or Unbranded

Code	Description	UOM	Price
G45810	A = 1.24mm (No.4/0) HSS	EACH	£5.50
0403WS40	A = 1.24mm (No.4/0) WS, Vallorbe	EACH	£11.50
G45811	A = 1.35mm (No.3/0) HSS	EACH	£5.50
0403WS30	A = 1.35mm (No.3/0) WS, Vallorbe	EACH	£11.50
G45812	A = 1.45mm (No.2/0) HSS	EACH	£5.50
0403WS20	A = 1.45mm (No.2/0) WS, Vallorbe	EACH	£9.50
G45813	A = 1.58mm (No.0) HSS	EACH	£5.50
0403WS0	A = 1.58mm (No.0) WS, Vallorbe	EACH	£9.50
G45814	A = 1.78mm (No.1) HSS	EACH	£5.50
0403WS1	A = 1.78mm (No.1) WS, Vallorbe	EACH	£9.90
G45815	A = 1.78mm (No.2) HSS	EACH	£5.50

0403WS2	A = 1.94mm (No.2) WS, Vallorbe	EACH	£9.90
0403WS3	A = 2.16mm (No.3) WS, Vallorbe	EACH	£10.35

## Graver, Oval or Bullsticks



Oval or Bull Stick - Gravers - Vallorbe Swiss

Used mostly on channel, tension and peg cluster settings for engraving accurate hand grooves for the diamond girdle to sit in securely; also known as the chisel tool for sculpturing or chasing.

- Tool Steel (WS) = Length 80mm
- Vallorbe Swiss

Code	Description	UOM	Price
040415	A = 1.50mm (No.15) WS	EACH	£10.95
040417	A = 1.70mm (No.17) WS	EACH	£10.95
040419	A = 1.90mm (No.19) WS	EACH	£10.95
040421	A = 2.10mm (No.21) WS	EACH	£10.95
040423	A = 2.30mm (No.23) WS	EACH	£10.95
040425	A = 2.50mm (No.25) WS	EACH	£10.95

## Graver, Round Edge



Round Edge (Half Round) - Gravers - Vallorbe Swiss or Unbranded

The round edge graver is predominantly used to grain set. This involves creating grains from the surface of the metal by pushing with the graver from the area immediately around the setting to secure the stone(s) in the set.

- Cut out half round curves and lines when engraving, chasing, decorating or sculpturing.
- Also known as a dotter when letter or script engraving, ideal for the full stop after a script engraved piece
- Tool Steel (WS) = Length 80mm
- High Speed Steel (HSS) = Length 65mm
- Vallorbe Swiss or Unbranded

Code	Description	UOM	Price
G45801	A = 0.20mm (No.2) HSS	EACH	£5.50
0402WS2	A = 0.20mm (No.2) WS, Vallorbe	EACH	£8.95
G45802	A = 0.40mm (No.4) HSS	EACH	£5.50
0402WS4	A = 0.40mm (No.4) WS, Vallorbe	EACH	£8.95
0402WS6	A = 0.60mm (No.6) WS, Vallorbe	EACH	£8.95
G45803	A = 0.60mm (No.6) HSS	EACH	£5.50
0402HSS6	A = 0.60mm (No.6) HSS, Vallorbe	EACH	£12.95
G45804	A = 0.80mm (No.8) HSS	EACH	£5.50
0402HSS8	A = 0.80mm (No.8) HSS, Vallorbe	EACH	£12.95
0402WS8	A = 0.80mm (No.8) WS, Vallorbe	EACH	£8.95
G45805	A = 1.00mm (No.10) HSS	EACH	£5.50
0402WS10	A = 1.00mm (No.10) WS, Vallorbe	EACH	£8.95
G45806	A = 1.20mm (No.12) HSS	EACH	£5.50
0402WS12	A = 1.20mm (No.12) WS, Vallorbe	EACH	£8.95
G45807	A = 1.40mm (No.14) HSS	EACH	£5.50
0402WS14	A = 1.40mm (No.14) WS, Vallorbe	EACH	£8.95
G45808	A = 1.60mm (No.16) HSS	EACH	£5.50
G45809	A = 1.80mm (No.18) HSS	EACH	£5.50

## Graver, Square



Square - Gravers - Vallorbe Swiss

The Square Graver will cut out star shapes into metal and also raises grains to secure the stone and to enhance the look of the stone (Bright cut).

**HAMMERS & MALLETS**

**HAMMERS**

Form – Bend - Flatten!

Our range of hammers and Mallets are made in all parts of the world. Our hammers encompass the highest quality, have finely balanced heads for simple and precise swinging as well as smoothly curved handles for an ergonomic grip.

- High grade heads for superior durability, high strength and long lasting working life.
- For working jewellers, silversmiths, model makers, arts/crafts, metal smiths, watch/clock makers and Repairers.

Which hammer do I need?

The hammers shown on this page are designed for a specific purpose or application. Here are some descriptions of the different types of hammers and their uses:

- **Riveting-** comprised of one round and one chisel face. Used for forming metal and for creating a rivet.
- **Ballpien** – a commonly used hammer for shaping and flattening metal and for removing dents; with one round face and one half round domed face.
- **Embossing-** also known as repoussé, its two high domed round faces, this hammer works the metal from the back to form three-dimensional shapes.
- **Forming-** used to move heavy-gauge metal while retaining much of the weight of the original metal. Substantial weight with a slightly rounded face
- **Planishing** - used for hardening metal and for smoothing the surface of gold, silver, brass, stainless steel and other metals.
- **Chasing** - a multipurpose hammer for chasing, chiselling, riveting or peening.
- **Stretching** - Used for expanding metals surface area
- **Polishing** – To creating indents in your metal with a hammered texture and smooth, shiny finish

Some hammer terms explained:

- **Riveting** – hammering a metal rod in a hole to create a head and fasten something.
- **Repoussé/Embossing** – the shaping of metal in relief by hammering on the reverse side.
- **Chasing** – the process of hammering metal to form a recessed shape
- **Planishing** - the process of hammering metal with a polished hammer to obtain an even surface
- **Chiselling** - by creasing metal over holes and grooves, an alternative riveting technique.
- **Peening** - is the process of hammering on a metal surface to strengthen the material properties of metal by hammering blows.

**Ball Pein**

Hammers - Ball Pein

- These hammers are used for flattening, shaping or removing dents
- Constructed with forged steel heads and hardwood handles

Cousins Ball Pein:  
• Excellent Quality

**Scrapers, Faithfull**



Jewellers, Engineers Scraper Tools - Faithfull

A hand scraper is a hand tool used to scrape metal from a surface. They are typically used to cut away unwanted solder, de-burring, trimming sharp edges on sheet metal, and creating a texturing effect.

- Fitted with a wooden handle
- Best grade hardened steel
- Excellent cutting finished edges

We supply a large range of sharpening stones ideal for maintained the sharpness of scraping tools, please see the link below to view the complete range.

Weight: 80 grams

Code	Description	UOM	Price
S33508	Half Round 100mm Engineers Hand Scraper	EACH	£3.80
S33509	Triangular 100mm Engineers Hand Scraper	EACH	£3.80

**Scrapers, Vallorbe**



Jewellers, Engineers Scraper Tools, Vallorbe Swiss  
Swiss Vallorbe Jewellers' Scrapers Tools are made from the highest quality hardened steel. The cutting edges are ground to perfection giving a razor sharp edge quality.

Their typical uses are for removing inner edge material and to cut away unwanted solder especially from bangles and rings. Create texturing effects to add contrast to jewellery and deburring sharp edges on sheet metals. Wooden handles are also available for these scraper tools please see link below to see whole range.

- Weight:
- 06532 – 5grams
  - 06533 – 12 gram
  - 06534 – 30 grams

Code	Description	UOM	Price
06532	Ø5.00mm Mechanics Scraper	EACH	£9.95
06533	Ø7.00mm Mechanics Scraper	EACH	£12.25
06534	Ø9.00mm Mechanics Scraper	EACH	£12.95

\*Bright cut – the action of cutting the surface of the area where the stone is to be set, in order to enhance the stone.

- Cut out parallel curves and lines when you are engraving, chasing, decorating or sculpting.
- For cutting and turning balance staffs in a watch and clock.
- Tool Steel (WS) = Length 110mm
- High Speed Steel (HSS) = Length 110mm
- Vallorbe Swiss

Code	Description	UOM	Price
0501WS150	A = 1.50mm WS	EACH	£6.60
0501WS175	A = 1.75mm WS	EACH	£6.45
0501WS200	A = 2.00mm WS	EACH	£6.45
0501HSS225	A = 2.25mm HSS	EACH	£17.95
0501WS225	A = 2.25mm WS	EACH	£5.80
0501HSS250	A = 2.50mm HSS	EACH	£15.50
0501WS250	A = 2.50mm WS	EACH	£6.45
0501HSS275	A = 2.75mm HSS	EACH	£15.50
0501WS275	A = 2.75mm WS	EACH	£6.60
0501HSS300	A = 3.00mm HSS	EACH	£17.95
0501WS300	A = 3.00mm WS	EACH	£6.45
0501WS325	A = 3.25mm WS	EACH	£7.70
0501HSS350	A = 3.50mm HSS	EACH	£17.95
0501WS350	A = 3.50mm WS	EACH	£7.50
0501HSS400	A = 4.00mm HSS	EACH	£17.95
0501HSS600	A = 6.00mm HSS	EACH	£21.25

**Scrapers**



Jewellers, Engineers Scraper Tools

Triangular scrapers with & without fluted groove for scraping / removing metal from a surface. They are typically used to cut away unwanted solder, de-burring, trimming sharp edges on sheet metal, and creating a texturing effect.

- Fitted with a wooden handle
- Excellent cutting finished edges
- Superb quality for the price
- Scraper length 70mm
- Overall length 170mm
- With or without fluted groove
- Made in India

Code	Description	UOM	Price
S36353	Triangular, Fluted	EACH	£1.95
S36352	Triangular, Solid	EACH	£1.95

**Scrapers, Black Blade**



Jewellers, Engineers Scraper Tools

Triangular, fluted scraper with an extendible black blade for scraping / removing metal from a surface. Typically used to cut away unwanted solder, de-burring, trimming sharp edges on sheet metal, and creating a texturing effect.

- Knurled metal handle
- Extendible black blade
- Excellent cutting finished edges
- Superb quality for the price
- Scraper length: from 10 to 80mm
- Handle length: 110mm
- With fluted groove
- Made in India

Code	Description	UOM	Price
G39334	Triangular, Fluted - Black Blade	EACH	£4.95

**Machine Gravers**

See Page 666



# HAMMERS & MALLETs

- Blue Finished Head
- Finely Polished Ends

Dimensions: Weight x Overall Length x Head Length x Head Ø

## 1oz (28g) 205 x 50 x 8mm



- Overall length 205mm
- Face diameter Ø8mm
- Head length 50mm

Dimensions: Weight x Overall Length x Head Length x Head Ø

Code	Description	UOM	Price
H39469	1oz (28g) 205 x 50 x 8mm	EACH	£2.15

## 1oz (28g) 210 x 50 x 8mm, Cousins



Cousins - Excellent Quality

A miniature scaled down version of the traditional ball pein hammer. Used for shaping metal, riveting etc.

- Blue Finished Head
- Finely Polished Ends
- Overall Length 210mm
- Head Length 50mm
- Head Ø8mm

Dimensions: Weight x Overall Length x Head Length x Head Ø

Code	Description	UOM	Price
H19522	1oz (28g) 210 x 50 x 8mm, Cousins	EACH	£3.95

## 2oz (56g) 230x 65 x 10mm



- Overall length 230mm
- Face diameter Ø10mm
- Head length 65mm

Dimensions: Weight x Overall Length x Head Length x Head Ø

Code	Description	UOM	Price
H39470	2oz (56g) 230x 65 x 10mm	EACH	£2.20

## 2oz (56g) 245 x 60 x 14mm, Cousins



Cousins - Excellent Quality

- Blue Finished Head
- Finely Polished Ends
- Overall Length 245mm
- Head Length 60mm
- Head Ø14mm

Dimensions: Weight x Overall Length x Head Length x Head Ø

Code	Description	UOM	Price
H19523	2oz (56g) 245 x 60 x 14mm, Cousins	EACH	£4.80

## 4oz (112g) 250 x 65 x 15mm



- Overall length 250mm
- Face diameter Ø15mm
- Head length 65mm

Dimensions: Weight x Overall Length x Head Length x Head Ø

Code	Description	UOM	Price
H39471	4oz (112g) 250 x 65 x 15mm	EACH	£3.50

## 4oz (112g) 270 x 75 x 15mm, Cousins



Cousins - Excellent Quality

- Blue Finished Head
- Finely Polished Ends
- Overall Length 270mm
- Head Length 75mm
- Head Ø15mm

Dimensions: Weight x Overall Length x Head Length x Head Ø

Code	Description	UOM	Price
H5107	4oz (112g) 270 x 75 x 15mm, Cousins	EACH	£5.50

## 8oz (200g) 260 x 80 x 20mm



- Overall length 260mm
- Face diameter Ø20mm
- Head length 80mm

Dimensions: Weight x Overall Length x Head Length x Head Ø

Code	Description	UOM	Price
H39466	8oz (200g) 260 x 80 x 20mm	EACH	£4.50

## Brass, Plastic & Steel

Hammers - Brass - Plastic - Steel

- These hammers offer lightweight, non marking effect.
- Used for forming and bending on metals including gold, silver, copper, brass, etc.

Dimensions: Weight x Head Length x Head Ø

## Brass, 84g (3oz) x 50 x 14mm



- Overall length 240mm
- Length of head 50mm
- Diameter of head Ø14mm
- Weight 84gms (3oz)
- Head faces: 1 domed & 1 flat

Code	Description	UOM	Price
H39472	Brass, 84g (3oz) x 50 x 14mm	EACH	£3.95

## Brass, 84g (3oz) x 60 x 16mm, Bergeon



Bergeon 30416 - Swiss Made

- Overall Length 230mm
- Length of Head 60mm
- Diameter of Head 16mm (5/8")
- Weight 84gms (3oz)
- Head Faces: 1 Domed & 1 Flat

Code	Description	UOM	Price
H0770	Brass, 84g (3oz) x 60 x 16mm, Bergeon	EACH	£17.75

## Brass, 84g (3oz) x 60 x 16mm, Cousins



- Overall Length 230mm
- Length of Head 60mm
- Diameter of Head 16mm (5/8")
- Weight 84gms (3oz)
- Head Faces: 1 Domed & 1 Flat

Code	Description	UOM	Price
H19524	Brass, 84g (3oz) x 60 x 16mm, Cousins	EACH	£8.95

## Brass & Plastic, 55g (2oz) x 51 x 13mm



- Head diameter Ø13mm
- Overall length 235mm
- Head length 51mm

Code	Description	UOM	Price
H19161	Brass & Plastic, 55g (2oz) x 51 x 13mm	EACH	£3.95

## Brass & Plastic, 55g (2oz) x 55 x 14mm



- Head diameter Ø14mm
- Overall length 235mm
- Head length 55mm
- Flat heads
- Aluminium handle

Code	Description	UOM	Price
H39474	Brass & Plastic, 55g (2oz) x 55 x 14mm	EACH	£3.95

## Brass, Plastic & Steel, 140g (5oz) Repousse



- 5 ounces
- Ø25mm head
- 3 screw on heads, brass, nylon and steel

- 260mm overall length

Code	Description	UOM	Price
H45548	Brass, Plastic & Steel, 140g (5oz) Repousse	EACH	£7.85

**Delrin, 56g (2oz) (Rounded & Wedged Faces)**



- Overall Length: 260mm
- Length of Head: 90mm
- Diameter of Head: Ø19mm
- Weight: 56g (2oz)
- Head Faces: 1 Rounded & 1 conical wedge

Code	Description	UOM	Price
H45830	Delrin, 56g (2oz) (Rounded & Wedged Faces)	EACH	£4.95

**Delrin, 88g (3oz) (Flat & Wedged Faces)**



- Overall Length: 240mm
- Length of Head: 85mm
- Diameter of Head: Ø24mm
- Weight: 88g (3oz)
- Head Faces: 1 Conical wedge & 1 flat

Code	Description	UOM	Price
H37132	Delrin, 88g (3oz) (Flat & Wedged Faces)	EACH	£4.95

**Multi Head, 150g (5.25oz)**



Excellent for a wide variety of work - 150g

With 6 interchangeable heads:

- Brass
- Metal
- Ball Pein
- Chisel
- Acrylic
- Regular

Code	Description	UOM	Price
H37829	Multi Head, 150g (5.25oz)	EACH	£4.95

**Steel 84g (3oz) x 40 x 15mm**



- Overall length 175mm
- Length of head 40mm
- Diameter of head Ø15mm
- Weight 84gms (3oz)

- Two flat faces

Code	Description	UOM	Price
H39473	Steel 84g (3oz) x 40 x 15mm	EACH	£2.95

**Steel & Plastic, 60g (2oz) x 55 x 12mm**



- Overall length 180mm
- Length of head 55mm
- Diameter of head Ø12mm
- Weight 60g (2oz)
- Two flat faces
- Steel & plastic face

Code	Description	UOM	Price
H45553	Steel & Plastic, 60g (2oz) x 55 x 12mm	EACH	£2.50

**Chasing (Polishing)**

Hammers - Chasing (Polishing)

Selection of bowed hammers, rounded and rectangular twin heads. Traditional and popular with silversmiths/craft metal workers

- Multipurpose hammers especially designed for chasing, peening, embossing, polishing and raising
- Well balanced hardwood handles offer comfort to allow more bounce back which reduces strain.
- Highly polished heads

Dimensions:

Weight x Overall Length x Head Length x Head Size

**Rectangular 9oz (315 x 115 x 23mm) Chasing**



- Two different extra shallow rectangle bowed faces, fine and extra fine
- Overall length 315mm
- Head length 115mm
- Head width 23mm
- 9oz

Dimensions:

Weight x Overall Length x Head Length x Head Size

Code	Description	UOM	Price
H35286	Rectangular 9oz (315 x 115 x 23mm) Chasing	EACH	£11.95

**Rectangular 17oz (315 x 115 x 28mm) Chasing**



- Two different extra shallow rectangle bowed faces, fine and extra fine
- Overall length 315mm

- Head length 115mm
- Head width 28mm
- 17oz

Dimensions:

Weight x Overall Length x Head Length x Head Size

Code	Description	UOM	Price
H35283	Rectangular 17oz (315 x 115 x 28mm) Chasing	EACH	£11.95

**Round 11oz (310 x 95 x 25mm) Polishing**



- 1 Round flat head Ø25mm
- 1 Ball Ø26mm
- Highly Polished Head
- Overall length 310mm
- Head length 95mm
- 11oz

Dimensions:

Weight x Overall Length x Head Length x Head Size

Code	Description	UOM	Price
H35285	Round 11oz (310 x 95 x 25mm) Polishing	EACH	£11.95

**Round 17oz (310 x 120 x 30mm) Polishing**



- 1 Round domed head Ø30mm
- 1 Round high domed head Ø30mm
- Highly Polished Head
- Overall length 310mm
- Head length 120mm
- 17oz

Dimensions:

Weight x Overall Length x Head Length x Head Size

Code	Description	UOM	Price
H35284	Round 17oz (310 x 120 x 30mm) Polishing	EACH	£11.95

**Chasing, Repousse (Embossing)**

Hammers - Chasing, Repousse (Embossing)

Chasing is the opposite of repousse, and the two are used in conjunction to create a finished piece. It is also known as embossing.

Repousse is used to work the reverse of the metal to form a raised design on the front, chasing is used to refine the design on the front of the work by sinking the metal.

- Highly Polished Heads
- One Round Large Surface for chasing or flattening
- One Pein for rivetting, metal design

These hammers have one large smooth face for striking, chasing, chiselling or planishing metal and one round face for rivetting, peening or metal design. The well balanced hardwood narrow necked handles offer comfort and reduces hand strain from the repousse 'bounce back' effect

## 4oz, Ø25 x 57 x 260mm



Weight 4oz  
 • Overall length 260mm  
 • Head length 57mm  
 • Head diameter 25mm

Code	Description	UOM	Price
H19526	4oz, Ø25 x 57 x 260mm	EACH	£6.50

## 5oz, Ø25 x 55 x 255mm



Weight 5oz  
 • Overall length 255mm  
 • Head length 55mm  
 • Head diameter Ø25mm

Code	Description	UOM	Price
H36260	5oz, Ø25 x 55 x 255mm	EACH	£3.95

## 5oz, Ø28 x 60 x 260mm



Weight 5oz  
 • Overall length 260mm  
 • Head length 60mm  
 • Head diameter 28mm

Code	Description	UOM	Price
H19527	5oz, Ø28 x 60 x 260mm	EACH	£6.95

## 6oz, Ø32 x 67 x 260mm



Weight 6oz  
 • Overall length 260mm  
 • Head length 67mm  
 • Head diameter 32mm

Code	Description	UOM	Price
H19528	6oz, Ø32 x 67 x 260mm	EACH	£7.50

## 7oz, Ø25 x 65 x 260mm, Domed Face



Weight 7oz  
 • Domed face  
 • Head Ø25mm  
 • Head length 65mm  
 • Overall length 260mm

Code	Description	UOM	Price
H41187	7oz, Ø25 x 65 x 260mm, Domed Face	EACH	£4.95

## Cross Pein

Hammers - Cross Pein - Warrington

- Also known as a Warrington hammer
- Usually used for driving nails, pins and rivets
- The cross pein is used to start the nail or pin, then the hammer is reversed to use the flat head to drive it home
- The steel heads on these hammers have a flat end and a chiselled end for forming and riveting for light to medium work

Dimensions: Weight x Overall Length x Head Length x Head Ø

## 4oz (330 x 100 x 15mm) Cross Pein, Faithful



- Weight 4oz
- Length overall 330mm
- Head length 100mm
- Round head Ø15mm
- Domed chisel width 16mm

Dimensions: Weight x Overall Length x Head Length x Head Ø

Code	Description	UOM	Price
H5106	4oz (330 x 100 x 15mm) Cross Pein, Faithful	EACH	£5.85

## 8oz (260 x 85 x 23mm) Cross Pein



- Weight 4oz
- Length overall 260mm
- Head length 85mm
- Round head Ø23mm
- Domed chisel width 16mm

Dimensions: Weight x Overall Length x Head Length x Head Ø

Code	Description	UOM	Price
H39465	8oz (260 x 85 x 23mm) Cross Pein	EACH	£3.95

## Goldsmiths Classic

Hammers - Goldsmiths

- These classic shaped hammers are commonly used in the workshops of goldsmiths
- Also for other kinds of uses for a wide variety of metal working
- With polished heads and hard wood handles the quality is exceptional particularly at this economical price
- The hex heads are flat and highly polished making it ideal for planishing
- The chiselled ends are perfect for riveting and raising, for medium to heavy use

Dimensions:

Head Shapes x Overall Length x Head Length x Head Size

## Hex/Hex (265 x 90 x 16mm)



Dimensions:

Head Shapes x Overall Length x Head Length x Head Size

- Overall length 265mm
- Head length 90mm
- Head diameter 16mm

Code	Description	UOM	Price
H31923	Hex/Hex (265 x 90 x 16mm)	EACH	£4.95

## Hex/Chisel (265 x 90 x 16mm)



Dimensions:

Head Shapes x Overall Length x Head Length x Head Size

- Overall length 265mm
- Head length 90mm
- Head diameter 16mm

Code	Description	UOM	Price
H31922	Hex/Chisel (265 x 90 x 16mm)	EACH	£5.75

## Round/Chisel (265 x 90 x 18mm)



Dimensions:

Head Shapes x Overall Length x Head Length x Head Size

- Overall length 265mm
- Head length 90mm
- Head diameter 18mm

Code	Description	UOM	Price
H19525	Round/Chisel (265 x 90 x 18mm)	EACH	£5.60

## Pattern & Texturing

Hammers - Pattern & Texturing

Superb double sided texturing hammers create a fantastic indent (cutting) or raised (blocking) pattern on your metals.

- "Cutting" is the official (Assay office) terminology for creating an indent pattern in your metals
- "Blocking" is the term for creating a raised pattern in your metal
- Experiment with our full range and give your work a unique, one off look by combining different pattern hammers
- Well balanced, hickory wooden handles
- For non-ferrous metals
- Multi-head hammer has 9 differing screw on pattern heads

How to use:

1. One must have a sturdy, flat work surface
2. Place a rubber planishing block on your surface (code D31265) and place a planishing block on top (Alternatively you can use the



A34915 dual planishing block, an all in one tool perfect for the texturing hammer pattern process)

3. Place your metal on the planishing steel block and choose a pattern hammer

4. Strike hammer pattern head over metal evenly to create fantastic effects

Dimensions: Overall Length x Head Length x Head Ø x Patterns

**230 x 70 x Ø29mm (Stripes & Chequered)**



- Dimensions:
- Pattern head size: Ø29mm
  - Head length: 70mm
  - Length of hammer: 230mm
  - Weight: 225 grams

Dimensions: Overall Length x Head Length x Head Ø x Patterns

Code	Description	UOM	Price
H36074	230 x 70 x Ø29mm (Stripes & Chequered)	EACH	£6.95

**230 x 70 x Ø29mm (Stripes & Holes)**



- Dimensions:
- Pattern head size: Ø29mm
  - Head length: 70mm
  - Length of hammer: 230mm
  - Weight: 225 grams

Dimensions: Overall Length x Head Length x Head Ø x Patterns

Code	Description	UOM	Price
H36075	230 x 70 x Ø29mm (Stripes & Holes)	EACH	£6.95

**250 x 60 x 18mm (9 Various Heads)**



- Texturing Hammer - Interchangeable Heads
- Overall Length 250mm
  - Head Length 60mm
  - Head Ø18mm

Head Patterns Included:  
 Plain - Single Hole - Single Round Raised Spike - Single Square Raised Spike - Single Pyramid Raised Spike - V Groove Stripes - Straight Groove Stripes - Diamond Chequered - Square Chequered

Dimensions: Overall Length x Head Length x Head Ø x Patterns

Code	Description	UOM	Price
H36076	250 x 60 x 18mm (9 Various Heads)	EACH	£16.95

**260 x 65 x 18mm (13 Various Heads)**



- Texturing Hammer - Interchangeable Heads
- Overall Length 265mm
  - Head Length 65mm
  - Head Ø18mm
  - Weight 425g

Head Patterns Include:  
 Brass flat - Brass Domed - Black Nylon Flat - White Nylon Domed - Round Pin - Square Pin - Tapered Cone - Dimple - Domed - Square Check - Horizontal Lines - Diamond Check - Waves.

Dimensions: Overall Length x Head Length x Head Ø x Patterns

Code	Description	UOM	Price
H41190	260 x 65 x 18mm (13 Various Heads)	EACH	£15.95

**Pattern & Texturing Superior Quality**

Hammers - Pattern & Texturing - Superior Quality

Superb double sided texturing hammers create a fantastic indent (cutting) or raised (blocking) pattern on your metals.

- "Cutting" is the official (Assay office) terminology for creating an indent pattern in your metals
- "Blocking" is the term for creating a raised pattern in your metal
- Experiment with our full range and give your work a unique, one off look by combining different pattern hammers
- Well balanced, hickory wooden handles
- For non- ferrous metals

How to use:

1. One must have a sturdy, flat work surface
2. Place a rubber planishing block on your surface (code D31265) and place a planishing block on top (Alternatively you can use the A34915 dual planishing block, an all in one tool perfect for the texturing hammer pattern process)
3. Place your metal on the planishing steel block and choose a pattern hammer
4. Strike hammer pattern head over metal evenly to create fantastic effects

- Dimensions:
- Pattern head size: Ø29mm
  - Head length: 70mm
  - Length of hammer: 265mm
  - Weight: 330grams



**4 Circle (Blocking) & Dimples (Cutting)**



Code	Description	UOM	Price
H36049	4 Circle (Blocking) & Dimples (Cutting)	EACH	£17.95

**Chequered (Cutting) & 6 Circle (Cutting)**



Code	Description	UOM	Price
H36050	Chequered (Cutting) & 6 Circle (Cutting)	EACH	£17.95

**Cross Pattern (Blocking) & 6 Wide Stripe (Cutting)**



Code	Description	UOM	Price
H36051	Cross Pattern (Blocking) & 6 Wide Stripe (Cutting)	EACH	£17.95

**Planishing & Stretching**

Hammers - Planishing - Stretching

Planishing Hammer

- Ideal for the metal smith, the tool for smoothing metals surfaces.

Stretching Hammer

- Using this hammer allows you to really move the metal or expand its surface area. Perfect for making vessels or bowls

Dimensions:  
 Weight x Overall Length x Head Length x Head Size



## 5oz (275 x 80 x 20) Planishing



- 1 Round head Ø20mm
- 1 Rectangle 19 x 21mm
- Head length 80mm
- Overall Length: 275mm
- Hickory Shaft
- Faithfull

Dimensions:

Weight x Overall Length x Head Length x Head Size

Code	Description	UOM	Price
H33139	5oz (275 x 80 x 20) Planishing	EACH	£14.75

## 21oz (310 x 120 x 30mm) Stretching



Highly Polished Heads with a well balanced hardwood handles offer comfort to allow more bounce back which reduces strain.

- 1 Round flat face
- 1 Round lightly domed face
- Head Ø30mm
- Head length 120mm
- Overall Length: 310mm

Dimensions:

Weight x Overall Length x Head Length x Head Size

Code	Description	UOM	Price
H35282	21oz (310 x 120 x 30mm) Stretching	EACH	£11.95

## Riveting Hammer

Hammers - Riveting

A very useful and multi-use hammer, it can be used to stretch wires, making flat head rivets as well as an excellent tool for everyday use in a watchmakers or jewellers workshop.

- Hardwood hammers with quality steel heads offer a chisel-shaped end for riveting with a square flat end for light-duty work
- Square face
- Rectangular shaped handle
- Lightweight
- Popular to use with watch bracelet removing tools, such as our economy bracelet removing set (B31272)

Dimensions: Head Length x Head Size x Overall Length x (Weight)

## 55 x 10 x 190mm (45g)



- 10 x 10mm face
- 55mm head length
- Overall length 190mm
- 45g

Code	Description	UOM	Price
H39467	55 x 10 x 190mm (45g)	EACH	£2.95

## 65 x 12 x 200mm (80g)



- 12 x 12mm face
- 65mm head length
- Overall length 200mm
- 80g

Code	Description	UOM	Price
H39468	65 x 12 x 200mm (80g)	EACH	£2.95

## Silversmiths "Lightweight"

Classic Silversmith Hammers - Lightweight

- Silversmith's hammers
- Embossing, raising, texturing & classic
- Polished steel faces
- Lightweight & easy to handle
- Ergonomic black wooden handle
- Overall length 220mm

See additional information for full specification

## Embossing Hammer



- Two rounded embossing surfaces

Code	Description	UOM	Price
H44312	Embossing Hammer	EACH	£8.95

## Embossing Hammer, Pointed



- One narrow pointed surface
- One rounded pointed surface
- Head length 65mm
- Overall weight 55g

Code	Description	UOM	Price
H44308	Embossing Hammer, Pointed	EACH	£8.95

## Raising Hammer, Narrow



- One 3mm thick face
- One 4mm thick face
- Head length 65mm
- Overall weight 55g

Code	Description	UOM	Price
H44309	Raising Hammer, Narrow	EACH	£8.95

## Raising Hammer, Extra Narrow



- One 1mm thick face
- One 1.5mm thick face
- Head length 70mm
- Overall weight 50g

Code	Description	UOM	Price
H44311	Raising Hammer, Extra Narrow	EACH	£8.95

## Silversmith Classic



- Two rounded faces
- Head length 65mm
- Overall weight 60g

Code	Description	UOM	Price
H44307	Silversmith Classic	EACH	£8.95

## Texturing Hammer



- One crossed surface
- One flat smooth surface
- Head length 70mm
- Overall weight 125g

Code	Description	UOM	Price
H44310	Texturing Hammer	EACH	£8.95

## Watchmakers & Jewellers, A\*F Swiss



A\*F Swiss

Watchmakers/Jewellers & Hobbyists hammers for delicate working.

- Hardwood hammers with high quality steel heads offer a chisel-shaped end for riveting with a flat end for light-duty work
- Popular to use with watch bracelet tools when tapping pin holders for accurate pressure, for example the A\*F Bracelet Pin Remover Set (B0144) and Standard Slots A\*F Bracelet Holding Tool (B0154)

Dimensions: Head Length x Overall Length x Head Diameter x Weight

Code	Description	UOM	Price
H0768	50mm (205 x Ø9mm) 25gms	EACH	£6.75
H8065	60mm (215 x Ø10mm) 40gms	EACH	£8.95



H0771	70mm (225 x Ø11mm) 54gms	EACH	£8.95
H0772	80mm (235 x Ø12mm) 70gms	EACH	£10.95

**Watchmakers & Jewellers, Bergeon**



Bergeon Swiss

Watchmakers/Jewellers & Hobbyists hammers for delicate working.

- Bergeon Swiss
- Hardwood hammers with extremely high quality steel heads offer a chisel-shaped end for riveting with a flat end for light-duty work
- Popular to use with Bergeon watch bracelet tools when tapping pin holders for accurate pressure, for instance Bergeon Bracelet Tool (B0151)

Dimensions: Head Length x Overall Length x Head Diameter x Weight

Code	Description	UOM	Price
H0766	50mm (205 x Ø9mm) 30grms	EACH	£17.45
H0769	60mm (215 x Ø9.5mm) 40gm	EACH	£18.45
H0767	70mm (220 x Ø10.5mm) 55gm	EACH	£18.95

**Watchmakers & Jewellers, Cousins**



Cousins - Excellent Quality

Watchmakers/Jewellers & Hobbyists hammers for delicate working.

- Hardwood hammers with quality steel heads offer a chisel-shaped end for riveting with a flat end for light-duty work
- Popular to use with watch bracelet removing tools, such as our Economy Bracelet Removing Set (B31272)

Dimensions: Head Length x Overall Length x Head Diameter x Weight

Code	Description	UOM	Price
H19517	50mm (205 x Ø9mm) 25g	EACH	£4.75
H19518	60mm (215 x Ø10mm) 35g	EACH	£5.25
H19519	70mm (230 x Ø11mm) 50g	EACH	£5.50
H19520	80mm (235 x Ø12mm) 65g	EACH	£5.95
H19521	90mm (250 x Ø14mm) 95g	EACH	£6.50

**MALLETS**

- Mallet - useful for forming, bending and shaping without scratching or marring surfaces.
- Multitude of face materials available including rawhide, nylon, rubber, wood or plastic.

We have a large range of soft mallets and hammers from all over the world, all made from the best quality materials, ensuring these tools last for life.

Thor Mallets made in Great Britain.

For over 50 years Thor mallets have specialized in the manufacture of these essential tools. This has enabled us to stock a wide range of none damaging, striking solutions for any problem where a hand tool is required.

Thor Mallet's reputation for quality is renowned particularly as it has held the ISO9002 approval since 1992. Users of Thor mallets include jewellers, silversmiths, model makers, light engineers and people in arts and crafts.

Thor also supply a range of mallets made from wood, brass and nylon all with the specific intention not to mark and damage work.

**Brass Mallets**



- Brass plated mallets
- Brass is a soft metal, does not damage what its hitting
- Ideal for use with disc cutters, as it does not damage the cutting tool
- Absorbs blows excellently

Dimensions: Weight x Overall Length x Head Length x Head Ø

Code	Description	UOM	Price
M41183	1lb (450g) 260 x 65 x Ø25mm	EACH	£9.95
M41184	2lb (900g) 275 x 65 x Ø33mm	EACH	£12.50

**Brass & Nylon Mallets**



- Brass & nylon head mallets
- Two options for your work
- Ideal for use with disc cutters, as it does not damage the cutting tool
- Absorbs blows excellently

Dimensions: Weight x Overall Length x Head Length x Head Ø

Code	Description	UOM	Price
M45831	5oz (150g) 250 x 90 x Ø25mm	EACH	£7.95
M45832	11oz (315g) 290 x 100 x Ø40mm	EACH	£9.50

**Nylon Mallets**



Mallets with special re-coiless festure & unbreakable nylon heads. The centrepiece of the hammer is in welded steel finished in lacquer. Varnished hickory wood handle.

Flat headed mallet provides the brawn to form and shape sheet metal quickly and productively.

- Thor or unbranded
- The hardwood handles give the most ergonomic spring action whilst in use
- Ideal for sheet metal work, shaping rings and forming etc.
- Solid heads
- Nylon will not splinter or fracture when hammering

Dimensions: Weight x Overall Length x Head Length x Head Ø

Code	Description	UOM	Price
M45833	6oz (175g) 310 x 90 x Ø38mm	EACH	£5.50
M33141	6oz (175g) 275 x 90 x Ø38mm, Thor	EACH	£8.15
M45834	9oz (250g) 320 x 90 x Ø50mm	EACH	£5.95
M45835	11oz (320g) 330 x 115 x Ø65mm	EACH	£7.95
M33142	11oz (320g) 300 x 115 x Ø50mm, Thor	EACH	£10.95

**Nylon Mallets (Screw Ends)**



Our Cousins special recoil-less hammer with unbreakable nylon ends. The centrepiece of the hammer is in welded steel finished in lacquer. Varnished hickory wood handle.

Flat headed mallet provides the brawn to form and shape sheet metal quickly and productively.

- The hardwood handles give the most ergonomic spring action whilst in use
- Ideal for sheet metal work, shaping rings and forming etc.
- With replaceable and interchangeable nylon heads
- Nylon will not splinter or fracture when hammering

Dimensions: Weight x Overall Length x Head Length x Head Ø

Code	Description	UOM	Price
M47710	6oz (170g) 240 x 85 x Ø20mm	EACH	£4.50
M47708	6oz (170g) 260 x 85 x Ø25mm	EACH	£4.95
H35281	7oz (190g) 250 x 95 x Ø25mm, Superior	EACH	£9.25
H39475	10oz (275g) 260 x 80 x Ø30mm	EACH	£5.50
M47711	Ø20mm Mallet Face (For M47710)	EACH	£1.50
M47709	Ø25mm Mallet Face (For M47708)	EACH	£1.50
M35299	Ø25mm Mallet Face, Superior (For M35299)	EACH	£1.75
H39476	Ø30mm Mallet Face (For H39475)	EACH	£1.50



## Nylon Mallets (Screw Ends), Thor



Our large range of Thor flat headed mallets provides the brawn to form and shape sheet metal quickly and productively.

- The nylon/ rubber & hardwood handles give the most ergonomic spring action whilst in use.
- Ideal for sheet metal work, shaping rings and forming etc.
- Available with interchangeable nylon heads or complete solid head.
- Handle gives just the right amount of spring when used.

M5319 = Thor THO708

M5318 = Thor THO710

M5320 = Thor THO712

Dimensions: Weight x Overall Length x Head Length x Head Ø

Code	Description	UOM	Price
M5319	9oz (260g) 250 x 100 x Ø25mm	EACH	£8.10
M5318	15oz (425g) 300 x 100 x Ø32mm	EACH	£9.50
M5320	23oz (650g) 300 x 115 x Ø38mm	EACH	£9.95
M5319A	Ø25mm Mallet Face (For M5319)	EACH	£0.98
M5318A	Ø32mm Mallet Face (For M5318)	EACH	£1.50
M5320A	Ø38mm Mallet Face (For M5320)	EACH	£2.05

## Nylon "Bossing" Mallets, Thor



Nylon, non marking heads mounted on wooden handles. These hammers provide the power to form and shape metal sheet quickly, a pre-repousse method.

A bossing mallet has an egg shaped head and is often used with a leather sandbag for hollowing or dishing sheet metal.

- Thor brand
- UK made
- High quality
- Pear shaped
- Ø50, 60 & 70mm

H34112 = Thor 8898SP

H34113 = Thor 8899SP

H34114 = Thor 8900SP

Dimensions: Weight x Overall Length x Head Length x Head Ø

Code	Description	UOM	Price
H34112	7oz (200g) 280 x 50 x Ø50mm	EACH	£14.95
H34113	10oz (275g) 300 x 130 x Ø60mm	EACH	£18.95
H34114	13.5oz (380g) 340 x 130 x Ø70mm	EACH	£22.95

 SAME DAY DISPATCH

## Rawhide Mallets, Indian



Best Indian mallets exceptional quality for the price.

- Made from natural buffalo hide tightly coiled and pressed 3 times for uniform quality and maximum durability
- Ideal for sheet metal work shaping rings bangles loops etc

Dimensions: Weight x Overall Length x Head Length x Head Ø

Code	Description	UOM	Price
M34951	3oz (90g) 280 x 75 x Ø25mm	EACH	£3.60
M34952	4oz (120g) 280 x 75 x Ø32mm	EACH	£4.10
M34953	4.5oz (130g) 290 x 75 x Ø38mm	EACH	£4.70
M34954	5oz (150g) 290 x 75 x Ø44mm	EACH	£5.85
M34955	7oz (200g) 310 x 75 x Ø50mm	EACH	£6.95

## Rawhide Mallets, Made in UK



Rawhide mallets made from the finest buffalo hide impregnated with shellac. Varnished handles made from selected ash wood.

- Varnished hides for extra protection
- High quality
- Cylinder shaped
- 7, 9 or 11 ounce
- Hickory handles
- Made in Great Britain

Dimensions: Weight x Overall Length x Head Length x Head Ø

Code	Description	UOM	Price
M44305	4oz (110g) 250 x 70 x Ø32mm	EACH	£8.95
M44304	9oz (250g) 290 x 80 x Ø45mm	EACH	£10.50
M44306	11oz (310g) 290 x 80 x Ø45mm	EACH	£10.95

 WORLDWIDE DELIVERY



**ORDER tracking**

Mandrels & Triblets for Rings

See Page 900



## Rawhide Mallets, Thor



Made from genuine buffalo hides, tightly coiled and pressed three times for uniform quality and maximum durability.

Ideal for sheet metal work, shaping rings and jewellers etc.

- Thor brand
- High quality
- Cylinder shaped
- Ø38, 44 & 50mm
- Made in Great Britain

M4750 = Thor THO112

M4751 = Thor THO114

M4752 = Thor THO116

Dimensions: Weight x Overall Length x Head Length x Head Ø

Code	Description	UOM	Price
M4750	6.5oz (190g) 265 x 90 x Ø38mm	EACH	£12.75
M4751	9oz (270g) 300 x 90 x Ø44mm	EACH	£13.30
M4752	12oz (340g) 300 x 100 x Ø50mm	EACH	£17.70

## Rubber Mallet, Vitrex

Rubber mallet prevents marking or damaging during hammering unlike using a conventional metal hammer.

- Excellent for repairs and manufacturing on items like silver trays, punch bowels, trophies, fruit bowels or classic car restoration such as bumpers and lights as well as on classic medieval armour.
- Remove dents and restore damaged pieces to the original look.
- Flatten out metal that has been cut or rolled through a rolling mill with no marking of the piece itself.
- If absolutely no marking is necessary in production use a rubber dapping block (code D31265) to hammer on
- Black or white rubber

Dimensions: Weight x Overall Length x Head Length x Head Ø

## 12oz (350g) 250 x 75 x Ø45mm (Black)



- Overall length: 250mm
- Length of head: 75mm
- Face diameter: Ø45mm
- Black rubber

Dimensions: Weight x Overall Length x Head Length x Head Ø

Code	Description	UOM	Price
M45836	12oz (350g) 250 x 75 x Ø45mm (Black)	EACH	£4.95

**18.5oz (530g) 310 x 85 x Ø50mm (White), Vitrex**



- Overall length: 310mm
- Length of head: 85mm
- Face diameter: Ø50mm
- White rubber

Dimensions: Weight x Overall Length x Head Length x Head Ø

Code	Description	UOM	Price
M33528	18.5oz (530g) 310 x 85 x Ø50mm (White), Vitrex	EACH	£4.65

**Wooden Mallet**

Hard Boxwood & Wooden Mallets:

- Ideal for sheet metal work
- Flattening and without marring
- Light in weight, no marking

Bossing Mallet:

- Made from traditional hard maple wood, this mallet provides the power to form and shape metal sheet quickly, a pre-repoussé method
- A bossing mallet has an egg shaped head and is often used with a leather sandbag for hollowing or dishing sheet metal
- This heavy duty mallet is a quality addition to your existing mallets

Head diameter in brackets

**Boxwood Mallet (Ø30mm), A\*F Swiss**



- A\*F Swiss 142.209
- Overall length: 220mm
- Length of head: 75mm
- Face diameter: Ø30mm

Dimensions: Weight x Overall Length x Head Length x Head Ø

Code	Description	UOM	Price
M34907	Boxwood Mallet (Ø30mm), A*F Swiss	EACH	£7.75

**Boxwood Mallet (Ø30mm), Bergeon**



- Bergeon 1447
- Overall length: 225mm
- Length of head: 75mm
- Face diameter: Ø30mm

Dimensions: Weight x Overall Length x Head Length x Head Ø

Code	Description	UOM	Price
M0962	Boxwood Mallet (Ø30mm), Bergeon	EACH	£7.75

**Wooden Mallet (Ø47mm)**



- Overall length: 310mm
- Length of head: 100mm
- Face diameter: Ø47mm
- Weight 9oz (260g)

Dimensions: Weight x Overall Length x Head Length x Head Ø

Code	Description	UOM	Price
M19730	Wooden Mallet (Ø47mm)	EACH	£3.65

**Bossing Mallet (Ø75mm)**



- Overall length: 325mm
- Length of head: 140mm
- Face diameter: Ø75mm
- Weight 21.5oz (610g)

Dimensions: Weight x Overall Length x Head Length x Head Ø

Code	Description	UOM	Price
M33140	Bossing Mallet (Ø75mm)	EACH	£49.95

**Wooden Mallet (Ø25mm)**



- Overall length: 230mm
- Length of head: 75mm
- Face diameter: Ø25mm
- Weight 7oz (200g)

Dimensions: Weight x Overall Length x Head Length x Head Ø

Code	Description	UOM	Price
M45837	Wooden Mallet (Ø25mm)	EACH	£3.95

**Wooden Mallet (Ø40mm)**



- Overall length: 250mm
- Length of head: 90mm
- Face diameter: Ø40mm
- Weight 8oz (225g)

Dimensions: Weight x Overall Length x Head Length x Head Ø

Code	Description	UOM	Price
M45838	Wooden Mallet (Ø40mm)	EACH	£4.25

**HAND REMOVING & ADJUSTING, CLOCK**

**Clock Hand Collet Adjusting Tool**

**Round Clock Hand Collet Adjusting Tool**



- Round Tip
- Tip 1 to 4mm
- Wooden Handle
- This tool is normally used for the adjustment of the bushing for hermle hands.

Hermle movements can strike a few minutes before or after the hour instead of directly on the hour to correct this you simply put the tool through the minute hand bush and rotate the hand slightly so the clock strikes exactly on the hour.

Code	Description	UOM	Price
B19167	Round Clock Hand Collet Adjusting Tool	EACH	£2.75

**Square Round Clock Hand Collet Adjusting Tool**



- Square Tip
- Tip 1 to 6mm
- Red Plastic Handle
- This tool is normally used for the adjustment of the bushing for hermle hands.

Hermle movements can strike a few minutes before or after the hour instead of directly on the hour to correct this you simply put the tool through the minute hand bush and rotate the hand slightly so the clock strikes exactly on the hour.

Code	Description	UOM	Price
B19168	Square Round Clock Hand Collet Adjusting Tool	EACH	£3.95

**Hammers**

See Page 906

**Rubber Planishing Block**

See Page 881



## Clock Hand Removing Levers



Bergeon 30032.04 - Swiss Made

For clocks and alarm clock. In specular polished hardened steel work surfaces. Mirror finished tips with knurled handles.

- Tip width: 15m
- Length: 210mm
- Weight 120gm

Code	Description	UOM	Price
H7351	15mm Wide, Bergeon 30032.04	PAIR	£89.95

## Clock Hand Removing, Screw Pressure

### Clock Hand Remover

- Indian
- D-Shape
- Weight 20gms



Code	Description	UOM	Price
H31259	Clock Hand Remover	EACH	£2.65

### Clock Hand Remover

- Economy
- Indian
- G-Shape



Code	Description	UOM	Price
H32055	Clock Hand Remover	EACH	£4.95

### Clock Hand Remover, Bergeon 30002

Clock Hand Remover

For clocks and alarm clocks, comes with two blades Large and small.

- Bergeon 30002
- Swiss Made



Code	Description	UOM	Price
H0788	Clock Hand Remover, Bergeon 30002	EACH	£29.95

### Blade (large) Bergeon 30002A

Clock Hand Remover Replacement Blade - Large

- Bergeon 30002A
- Swiss Made



Code	Description	UOM	Price
H0789	Blade (large) Bergeon 30002A	EACH	£3.70

### Blade (small) Bergeon 30002B

Clock Hand Remover Replacement Blade - Small

- Bergeon 30002B
- Swiss Made



Code	Description	UOM	Price
H0790	Blade (small) Bergeon 30002B	EACH	£3.70

## HANDLES FOR FILES, GRAVERS & BROACHES



Handles for Files, Gravers & Broaches

Take a look at our large range of Handles.

Quick guide to mounting / fitting your various handles:

Graver handles vary in size and shape. Selection depends upon one's own hand grip control and comfort. For these reasons it is common to collect an assortment of handles.

New gravers are normally too long and must be cut back to reduce the excessive length. If the handle is more than a couple of inches long, a new graver would have to be cut back that much more to accommodate one's hand control.

However, as gravers are continually re-sharpened they become shorter. Hence, the change to a longer graver handle should be optioned rather than discarding the graver. Our ranges of quality graver handles are designed for durability. The fine finished hardwood is contoured to provide comfort and a sure grip. A metal band near the opening end secures the graver and acts to keep the wood from splitting when the graver is inserted.

Files come in all kinds of shapes and sizes and selection depends on hand grip, control and comfort. We supply a large range of file handles including with collet grip for needle files (H0858) and twist on handles (H7987)

along with hardened traditional wooden handles.

Mounting your files and gravers on to the handles is simple with none collet or twist handles. Please see the guide below to mount the graver correctly.

Handling gravers after preparation is simple. After shaping the graver to the right size put the graver into a vice (V5345) and use vice grips (FDASJ35) so the leather grips do not mark the graver; then heat the blue end with a torch (M4184) for between one and two minutes. Push on the handle making sure the top and bottom end of the graver touches the metal support ring collet. Leave to cool for thirty minutes, the graver is ready to use.

Files are just as easy to mount. Insert the file into a vice (V5345) and use vice grips (FDASJ35) so the leather grips do not mark the file; then heat the 'tang' or the 'grip' end with a torch (M4184) for between one and two minutes. Push on the handle making sure the top and bottom end of the file touches the metal support ring collet. Leave to cool for thirty minutes, the file is ready to use.

## Universal Chucks with Fixed Handle

Wooden Handle - Universal Chuck

Popular range of universal chuck and handle for multiple applications for holding gravers, files, beading, millgrain and many other uses. With a wooden or plastic handles for a comfortable grip.

- Fixed handles
- Wood handles
- Best quality A\*F Swiss

### Zero to Ø2.75mm, Wood Handle



Universal Chuck with Fixed Wooden Handle

- Overall Length 75mm
- Pear Shaped Handle Diameter 30mm
- Supplied with 2 Collets
- Weight 60g

Code	Description	UOM	Price
P31900	Zero to Ø2.75mm, Wood Handle	EACH	£2.95

PRICE PROMISE  GUARANTEE

Gravers or Scorpers & Deburring

See Page 904



**Zero to Ø2.75mm, Wood Handle**



Universal Chuck with Fixed Wooden Handle  
 • Overall Length 75mm  
 • Mushroom Shaped Handle Daimeter 30mm  
 • Supplied with 2 Collets  
 • Weight 60g

Code	Description	UOM	Price
P47016	Zero to Ø2.75mm, Wood Handle	EACH	£2.95

**Zero to Ø3.00mm, Wood Handle, A\*F Swiss**



A\*F Swiss - Universal Chuck with Fixed Wooden Handle  
 • Overall Length 73mm  
 • Mushroom Handle Daimeter 34mm  
 • Supplied with 2 Collets  
 • Weight 30g

Code	Description	UOM	Price
P1220	Zero to Ø3.00mm, Wood Handle, A*F Swiss	EACH	£8.25

**Zero to Ø3.00mm, Wood Handle, A\*F Swiss**



A\*F Swiss - Universal Chuck with Fixed Wooden Handle  
 • Overall Length 70mm  
 • Ball Handle Daimeter 34mm  
 • Supplied with 2 Collets  
 • Weight 30g

Code	Description	UOM	Price
H47366	Zero to Ø3.00mm, Wood Handle, A*F Swiss	EACH	£8.75

**for Ø2.35mm Shanks, Wood Handle, A\*F Swiss**



A\*F Swiss - Universal Chuck with Fixed Wooden Handle  
 • Closing to Ø3.00mm  
 • Overall Length 73mm  
 • Handle Daimeter 34mm  
 • Handle Mushroom Shape with Cut Out  
 • Supplied with 1 Collets  
 • Weight 30g

Code	Description	UOM	Price
H47365	for Ø2.35mm Shanks, Wood Handle, A*F Swiss	EACH	£8.75

**Universal Chucks with Handle, Spindle Mountable**

Wooden Handle - Universal Chuck - Spindle Mountable

Easily mounts onto a tapered spindle simply by screwing., the metal ring gives added strength when fixing and removing.

Ideal if you have ever had difficulties drilling, polishing, grinding, etc in small areas because regular mops and abrasives are too large. This added on tool fits tapered spindles with ease. You now can mount a large variety of attachments like Mini Mops, Silicon Finishers and Mounted Roll Sanders/ Drum Sanders etc.

- Overall Length 89mm
- Metal Ring Ø18mm
- Hole Ø7mm approx.
- Handle Daimeter 25mm
- Supplied with 1 Collets
- Weight 30g

Code	Description	UOM	Price
H47368	Ø2.20 to Ø3.00mm Universal Handle, A*F Swiss	EACH	£11.75

**Universal Chuck with Rotating Handle**

**Ø0.00 to 2.50mm Wood Handle**



Universal Chuck with Rotating Handle  
 With drum for extra purchase & grip for power increase etc.  
 • Overall Length 90mm  
 • Handle Daimeter 32mm  
 • Supplied with 2 Collets  
 • Weight 35g

Code	Description	UOM	Price
P20016	Ø0.00 to 2.50mm Wood Handle	EACH	£4.15

**Zero to Ø3.00mm Universal Handle**



Universal Chuck & Handle  
 • Overall Length 100mm  
 • Metal Ring Ø13mm  
 • Hole Ø7mm approx.  
 • Handle Daimeter 35mm  
 • Supplied with 2 Collets  
 • Weight 45g

Code	Description	UOM	Price
D20130	Zero to Ø3.00mm Universal Handle	EACH	£2.95

**Ø2.20 to Ø3.00mm Universal Handle, A\*F Swiss**



A\*F Swiss - Universal Chuck & Handle

**Ø0.00 to 2.80mm Wood Handle**



Universal Chuck with Rotating Handle  
 With knurling for extra purchase & grip for power increase etc.  
 • Overall Length 100mm  
 • Head Daimeter 20mm  
 • Supplied with 2 Collets  
 • Second collet stored in upper part of handle  
 • Weight 35g

Code	Description	UOM	Price
P33220	Ø0.00 to 2.80mm Wood Handle	EACH	£4.95

**Bench Vices**

**See Page 1046**

**Broaches, Cutting & Smoothing**

**See Page 795**

## Ø0.00 to 3.25mm, Plastic Handle



Universal Chuck with Rotating Plastic Handle  
With drum for extra purchase & grip for power increase etc.

- Overall Length 85mm
- Handle Diameter 32mm
- Supplied with 4 Collets
- Weight 100g

Code	Description	UOM	Price
V39485	Ø0.00 to 3.25mm, Plastic Handle	EACH	£4.50

## Quickchange Multi Handle



A great product, this pair of handles feature allen screws which hold your file, graver or broach in place, meaning that swapping a tool over is as quick and simple as using an allen key

- Set of 2
- Rose wood handles
- Allen key provided
- Ø25mm

Code	Description	UOM	Price
H39428	Quickchange Multi Handle	PACK*2	£6.50

## Pear



Code	Description	UOM	Price
H36474	45mm Long, Ø35mm	EACH	£0.55
H4619	60mm Long, Ø35mm	EACH	£0.55
H4622	90mm Long, Ø27mm	EACH	£0.55

## Ø3.00mm to Ø1.80mm, Wood Handle, A\*F Swiss



A\*F Swiss - Universal Chuck with Fixed Wooden Handle  
With drum for extra purchase & grip for power increase etc.

- Closing from Ø3.00mm to Ø1.80mm
- Overall Length 95mm
- Handle Diameter 34mm
- Supplied with 1 Collets
- Weight 48g

Code	Description	UOM	Price
H47367	Ø3.00mm to Ø1.80mm, Wood Handle, A*F Swiss	EACH	£16.95

## Round



Code	Description	UOM	Price
H4618	40mm Long, Ø38mm	EACH	£0.55

## Mushroom



Code	Description	UOM	Price
H36476	45mm Long, Ø33mm	EACH	£0.60
H36471	52mm Long, Ø30mm	EACH	£0.55

## Round with Flat



Code	Description	UOM	Price
H36477	25mm Long, Ø30mm	EACH	£0.55
H36085	30mm Long, Ø35mm	EACH	£0.55

## Universal Needle File Handles



Universal Chuck - Needle File Handles

Popular range of universal chuck handles for holding needle files or other tools with square or round shanks. In wood or plastic triangular shape (to prevent rolling on the bench) these chuck handles will hold files secure for precision work whilst providing a comfortable grip.

- Fixed handles
- Wood or plastic handles
- Ideal for needle files

Code	Description	UOM	Price
H47137	Ø2.50, Red Plastic Handle	EACH	£5.75
H47136	Ø3.50, Blue Plastic Handle	EACH	£7.15
H0858	Ø2.50 to Ø3.30mm, Wood Handle	EACH	£2.20

## Mushroom with Cut Out



Code	Description	UOM	Price
H36469	40mm Long, Ø28mm	EACH	£0.55
H4617	45mm Long, Ø33mm	EACH	£0.55
H36470	55mm Long, Ø35mm	EACH	£0.55

## Straight



Code	Description	UOM	Price
H4620	75mm Long, Ø22mm	EACH	£0.80
H4623	100mm Long, Ø10mm	EACH	£0.80
H4621	100mm Long, Ø23mm	EACH	£0.80

## Straight with Mushroom



- Straight with mushroom head
- 125mm long
- 22mm
- Wooden handle

Code	Description	UOM	Price
H41189	125mm Long, Ø22mm	EACH	£1.50



**Straight, Acrylic**



- Bergeon 5091.14
- Acrylic, for gravers or small files

Code	Description	UOM	Price
H0857	80mm Long, Ø20mm	EACH	£6.95

**Straight, Plastic**



- Straight
- Plastic, comfy handle
- 100mm long
- 30mm wide
- 25mm deep
- Fitting hole size Ø10mm
- Colours may vary

Code	Description	UOM	Price
H39454	100mm Long, 25mm Wide	EACH	£0.95

**Straight, Plastic**



- Straight
- Plastic, comfy handle
- 100mm long
- Ø25mm
- Fitting hole size Ø8mm
- With threaded hole for extra grip
- Unbreakable
- Colours may vary

Code	Description	UOM	Price
H39453	100mm Long, Ø25mm	EACH	£1.95

**Straight, Plastic - Quickchange**



- Straight
- Plastic
- Quickchange, simply unscrew the top ring to change files/gravers/scrapers in double quick time
- 90mm long

• Diameter Ø20mm

Code	Description	UOM	Price
H45823	90mm Long, Ø90mm	EACH	£1.75

**Straight, Plastic - Swiss Made**



File handles in blue plastic. Fits the hand perfectly and grips the file tang firmly. Available in different sizes and socket diameters to facilitate all applications.

- Swiss Made
- Best Quality
- Various Handles Sizes
- Various Hole Diameters

Code	Description	UOM	Price
H47138	Small Handle (75mm) Ø2mm Hole	EACH	£0.95
H47139	Small Handle (75mm) Ø3mm Hole	EACH	£0.95
H47140	Small Handle (75mm) Ø4mm Hole	EACH	£0.95
H47141	Small Handle (75mm) Ø5mm Hole	EACH	£0.95
H47142	Medium Handle (90mm) Ø2mm Hole	EACH	£0.99
H47143	Medium Handle (90mm) Ø3mm Hole	EACH	£0.99
H47144	Large Handle (120mm) Ø10mm Hole	EACH	£1.25

**Straight, Plastic - Vallorbe**



File handles in anti-slip blue plastic with hardened thread insert. Fits the hand perfectly and grips the file tang firmly. Available in different sizes and socket diameters.

- Swiss Made
- Best Quality
- Vallorbe Crocodile Style
- Anti-Slip Plastic
- Hardened Thread Insert

Dimensions: Hole Diameter x Overall Length

Code	Description	UOM	Price
H47145	No.2 - Hole Ø4.20mm, L=94mm	EACH	£2.95
H47146	No.4 - Hole Ø7.00mm, L=105mm	EACH	£2.95
H47147	No.7 - Hole Ø12.5mm, L=131mm	EACH	£2.95

PRICE PROMISE GUARANTEE

Hand Held Magnifiers

See Page 850



**Straight with "Twist On"**



- A hard ribbed insert firmly grips the file tang when twisted in place
- Maximum capacity Ø7mm
- Length 115mm
- Handle Ø30mm

Code	Description	UOM	Price
H7987	115mm Long, Ø30mm	EACH	£2.20

**MAGNETS**

**Magnets**

These magnets are an excellent aid for detecting fallacious materials when precious metal testing. Additionally they are ideal for preliminary tests before the filing and acid testing processes.

Furthermore, owing to metallic inclusions, synthetic diamonds may be attracted or repelled by this magnet as natural diamonds are not magnetic.

Please do not include magnets in your order if you have also ordered the following items as magnets have an adverse effect on them and will cause damage:

- Movements
- Circuits
- Electrical equipment
- Batteries

**Horseshoe Magnet 28 x 25mm**

- Traditional 'horse shoe' magnet
- A protective steel safety plate is included
- Ideal pocket size weighing only 35g
- Roebuck tools

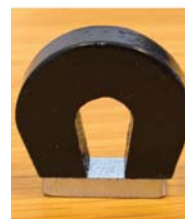

Size: 22mm x 25mm x 8mm

Code	Description	UOM	Price
M34117	Horseshoe Magnet 28 x 25mm	EACH	£3.95

**Magnet Block, 20mm x15mm x 6mm**

Length x Width x Depth Magnet for the testing of precious items including gold, silver and platinum. This high strength pocket size magnet will test for base metal in jewellery. Additionally, they are ideal for a preliminary test before filing and applying acid to the piece.



Code	Description	UOM	Price
M20858	Magnet Block, 20mm x15mm x 6mm	EACH	£2.50

## Magnet with Handle, Ø45mm x Ø 23mm

- Circular magnet
- Outside diameter Ø45mm
- Inside diameter Ø23mm
- Overall height 65mm
- Handle diameter Ø40mm



Code	Description	UOM	Price
M38657	Magnet with Handle, Ø45mm x Ø 23mm	EACH	£4.95

## Magnets, Telescopic Pick Up Tool



This superb tool is a great addition to a work shop and essential for anyone working with small metal parts.

- Pen style
- Extendible to 80cm
- Collapses to 16.5cm
- Ø12mm Magnet
- Colour may vary

Please do not include magnets in your order if you have also ordered the following items as magnets have an adverse effect on them and will cause damage:

- Movements
- Circuits
- Electrical equipment
- Batteries

Code	Description	UOM	Price
M39689	Magnetic Pick Up Tool	EACH	£2.95

## Magic Wiper, Bergeon



Magnet - Magic Wiper - Bergeon Swiss

- For recovering small metal pieces or dropped watch parts
- Tearproof & washable
- Consists of 2 double-sided magnetic strips
- Supplied flat
- Folded dimensions: 285 x 82mm
- Bergeon 7871

Code	Description	UOM	Price
M39011	Magic Wiper, Bergeon Swiss	EACH	£9.95

# MAINSRING TOOLS

## Clock, Bergeon 4126



Clock Mainspring Winder - Bergeon 4126

Comprises frame and crank with reversible ratchet device, 3 hooks and one double pin post for coiling spring to desired diameter before fitting. (Vice not included).

- For clock mainsprings for French & German clocks
- Overall length 180mm
- Height 100mm
- Width 30mm
- 1.5Kg

Code	Description	UOM	Price
M0954	Bergeon 4126 Clock Mainspring Winder	EACH	£136.75

## Clock, Bergeon 30076



This set contains: 1 heavy varnished cast iron frame, to be held in the bench vice. 2 crank handle, 8 barrels.

This BERGEON mainspring winder is very useful for clocks, alarm clocks and counters.

- Winds right or left hand springs
- Very easy and safe.
- In wooden case.
- 8 barrels in sizes 18 - 65mm

Additional Barrel Ø85mm available, item M0956

Code	Description	UOM	Price
M0955	Bergeon 30076 Clock Mainspring Winder	EACH	£765.00

## Clock, Bergeon 30076.9

Clock Mainspring Winder - Oversize Barrel - Ø85mm

- Bergeon 30076.9
- For Mainspring Winder M0955

Additional barrel size for large mainsprings, Ø85mm



Code	Description	UOM	Price
M0956	Clock Mainspring Winder Oversize Barrel, Bergeon 30076.9	EACH	£149.95

## Clock Let Down Tool, Bergeon 2301



Key to let down and wind up clock mainsprings.

Contains:

- 1 chuck holder fitted with a rubber handle
- 24 numbered chucks with winding squares from No 000 to 21 (Ø1.75 to Ø7.50 mm)
- Steps of 0.25 mm
- 1 special winding chuck for alarm clocks
- 1 removable metal handle
- In wooden case

Instruction for use

- For let down a mainspring

Choose the chuck corresponding to the winding square arbor and fix it to the tool. Put the tool into the square arbor. Exert a firmly pressure on the rubber cylinder. Turn slightly the tool clockwise. Lift up the click with the left hand. Let down by progressively releasing grip, so that the rubber cylinder slowly rubs on the tool.

- For winding up mainsprings

Choose the chuck corresponding to the winding square arbor and fix it to the tool provided with the metal handle. Wind up as with a normal key.

Code	Description	UOM	Price
M0887	Bergeon Clock Mainspring Let Down Tool	EACH	£885.00

## Clock Let Down Tool



Mainspring let down tools are used to safely unwind your clock's powerful mainspring, so that you may disassemble the movement for proper cleaning and lubrication without injuring yourself and causing extensive damage to the movement.

A clock key goes into the chuck and the chuck goes into the handle so you can let down the power of the spring. It does the same job as the let down tool with all the chucks as it can hold various sizes of key

- Can hold multiple sizes of key
- Maximum key handle width (to fit in the chuck) 1.50mm
- Durable plastic handle
- Double ended key shaft made from quality steel
- Key supplied separately

Code	Description	UOM	Price
M41162	Mainspring Let Down Tool	EACH	£11.95

Improved  
Competitive  
Carriage Costs

## WORLDWIDE DELIVERY

### Demagnetizers

See Page 657



### Clock Let Down Tool with 3 Key Shafts



Mainspring let down tools are used to safely unwind your clock's powerful mainspring, so that you may disassemble the movement for proper cleaning and lubrication without injuring yourself and causing extensive damage to the movement.

- Durable plastic handle
- Double ended key shafts made from quality steel
- 3 double ended key shafts: No.5, 6, 7, 8, 10 & 12

Code	Description	UOM	Price
M41163	Mainspring Let Down Tool with 3 Key Shafts	EACH	£14.75

### Clock Let Down Tool with 6 Key Shafts, Cousins



Permits confident release of mainspring power prior to disassembly, shafts hold firmly in the solid resinous holder.

- Contains:
- Set of six precision double ended steel key shafts
  - Universal holder

Imperial clock key sizes:

- 12 popular sizes included; 2/3, 4/5, 6/7, 8/9, 10/11 & 12/14.

Made in UK

Code	Description	UOM	Price
L6478	Mainspring Let Down Tool with 6 Key Shafts, Cousins	EACH	£75.00
H12039	Handle only for Cousins Let Down Tool	EACH	£5.95

### Clock, Rivot End Winder



Clock - Rivot End - Mainspring Winder

1. Insert the main wheel and winding arbor in the tool.
2. Clamp the main wheel to the tool.
3. Hook the loop end of the mainspring over the short outside pin.
4. Wind from the bottom with a key.
5. Insert a mainspring clamp over the mainspring once

it is wound to the required diameter.  
6. Wear protective glasses and gloves.

Code	Description	UOM	Price
M31427	Clock Mainspring Winder for Rivot End Mainsprings	EACH	£5.95

### Watch, Bergeon 2795-ETA



Bergeon 2795ETA

Assortment of 12 mainspring winders for ETA calibres contents includes one handle in wooden case with the following winders.

Set includes:

- 2729ETA01 suitable for calibre 1727
- 2729ETA02 suitable for calibres 2000.1/2004.1/2094
- 2729ETA03 suitable for calibres 2660/2671/2678/2688
- 2729ETA04 suitable for calibres 2801.2/2804.2
- 2729ETA05 suitable for calibres 2824.2/2834.2/2836.2
- 2729ETA06 suitable for calibre 2846.2
- 2729ETA07 suitable for calibres 2892A2/2893.1 .2 .3/2894.2/2895.2/2896/2897
- 2729ETA08 suitable for calibre 7001
- 2729ETA09 suitable for calibres 7750/7751/7753/7754
- 2729ETA10 suitable for calibres 7760/7765
- 2729ETA11 suitable for calibres 6497.1/6498.1
- 2729ETA12 suitable for calibres 6497.2/6498.2

Replacement winder handles, see our codes M43272 & M43273

Replacement winders available, see our code M44115

Code	Description	UOM	Price
M20152	Assortment of 12 Mainspring Winders for ETA Calibres	EACH	£575.00

### Watch, Bergeon 5355



Assortment of 7 right hand mainspring winders & 7 left hand arbors for mainsprings

- Ø5.60mm to Ø9.80mm right hand mainspring winders and handle

- Ø5.60mm to Ø9.80mm left hand arbors and handle
- No.0 to 6 right & left hand
- In wooden case
- Pack\*16
- Winders available separately, see code M40221
- Winder Handles available separately, see codes M43272 & M43273

Set Includes (right and left hand):

- No.0 = Ø5.60mm
- No.1 = Ø6.00mm
- No.2 = Ø6.50mm
- No.3 = Ø7.10mm
- No.4 = Ø7.80mm
- No.5 = Ø8.60mm
- No.6 = Ø9.80mm
- Right hand handle
- Left hand handle

Code	Description	UOM	Price
M38468	Mainspring Winder, Bergeon 5355	EACH	£429.95

### Watch, Bergeon 5356



Mainspring Winder - Wrist & Pocket Watch

- Assortments of 17 winders & 17 arbors for Nivaflex mainsprings and other qualities of steel
- Winders available separately, see code M40221
- Winder Handles available separately, see codes M43272 & M43273

Contents:

- 17 mainspring winders for right hand No 00 - 15 and 1 handle
- 17 arbors for left hand No 00 - 15 and 1 handle
- Ø5.3mm to Ø19mm
- In wooden case
- Red point: on right
- Blue point: on left

Code	Description	UOM	Price
M0952	Bergeon 5356 Pocket and Wrist Watch Mainspring Winder	EACH	£915.00

### Watch, Bergeon Arbors for Winders

- Replacement arbors for Bergeon mainspring winders
- Can turn a right hand winder into a left hand winder
- Can be used with any Bergeon mainspring winders, including our sets M38468 & M0952
- To be used with mainspring winders, see code M40221 for range
- If size is not currently listed, please ask via our online support system
- Bergeon 2729.MNG.XX



Code	Description	UOM	Price
M49225	Left Hand, Ø8.60mm (No.5) Arbor	EACH	£21.95
M48702	Left Hand, Ø10.80mm (No.7) Arbor	EACH	£21.95
M48703	Left Hand, Ø12.00mm (No.8) Arbor	EACH	£21.95
M48704	Left Hand, Ø13.00mm (No.9) Arbor	EACH	£21.95
M48705	Left Hand, Ø14.00mm (No.10) Arbor	EACH	£21.95
M48706	Left Hand, Ø15.00mm (No.11) Arbor	EACH	£21.95

# MARKING & SCORING

<b>M48707</b>	Left Hand, Ø16.00mm (No.12) Arbor	EACH	<b>£21.95</b>
<b>M48708</b>	Left Hand, Ø17.00mm (No.13) Arbor	EACH	<b>£21.95</b>
<b>M48709</b>	Left Hand, Ø18.00mm (No.14) Arbor	EACH	<b>£21.95</b>
<b>M48710</b>	Left Hand, Ø19.00mm (No.15) Arbor	EACH	<b>£21.95</b>

## Watch, Bergeon Handle for Winders



- Cylindrical handles for watch mainspring winders
- Plunger releases the mainspring straight from the winder into the barrel
- Right & left hand
- Can be used with any Bergeon mainspring winders, including our sets M20152, M38468 & M0952
- To be used with mainspring winder arbors, see code M40221 for range
- Bergeon 30082-M & 30082-MG
- Swiss

Code	Description	UOM	Price
<b>M43273</b>	Left Hand Mainspring Winder Handle	EACH	<b>£33.25</b>
<b>M43272</b>	Right Hand Mainspring Winder Handle	EACH	<b>£33.25</b>

## Watch, Bergeon Winders by Calibre

- Bergeon watch mainspring winders by calibre
- Barrel drum and arbor
- Replacements for all Bergeon sets
- For use with Bergeon winder handles, our code M43272 & M43273
- Replacements for our set M20152



Code	Description	UOM	Price
<b>M44115</b>	AS 1727	EACH	<b>£47.50</b>
<b>M44116</b>	ETA 2000.1, 2004.1, 2094	EACH	<b>£47.50</b>
<b>M44117</b>	ETA 2660, 2671, 2678, 2688	EACH	<b>£47.50</b>
<b>M44118</b>	ETA 2801.2, 2804.2	EACH	<b>£47.50</b>
<b>M42400</b>	ETA 2824.2, 2834.2, 2836.2	EACH	<b>£44.75</b>
<b>M44119</b>	ETA 2846.2	EACH	<b>£47.50</b>
<b>M44120</b>	ETA 2892A2, 2893.1 .2, 3, 2894.2, 2895.2, 2896, 2897	EACH	<b>£47.50</b>
<b>M44121</b>	ETA 7001	EACH	<b>£47.50</b>
<b>M44123</b>	ETA 6497.1, 6498.1	EACH	<b>£47.50</b>
<b>M44124</b>	ETA 6497.2, 6498.2	EACH	<b>£47.50</b>
<b>M41896</b>	Valjoux 7750, 7751, 7753, 7754 Winder	EACH	<b>£44.75</b>
<b>M44122</b>	Valjoux 7760, 7765	EACH	<b>£47.50</b>

## Watch, Bergeon Winders by Size

- Bergeon watch mainspring winders by size
- Barrel drum and arbor
- Replacements for all Bergeon sets
- For use with Bergeon winder handles, our code M43272 & M43273



- Replacements for our sets M38468 & M0952
- Right or left hand available
- If size is not currently listed, please ask via our online support system
- Bergeon 2729

- Dimensions:
- Right/Left Handed, Size (Bergeon number)
  - Size equals barrel drum size

Code	Description	UOM	Price
<b>M47696</b>	Left Hand, Ø6.00mm (No.1) Winder	EACH	<b>£39.95</b>
<b>M47697</b>	Left Hand, Ø6.50mm (No.2) Winder	EACH	<b>£39.95</b>
<b>M45736</b>	Left Hand, Ø7.80mm (No.4) Winder	EACH	<b>£39.95</b>
<b>M48985</b>	Left Hand, Ø9.80mm (No.6) Winder	EACH	<b>£39.95</b>
<b>M44277</b>	Left Hand, Ø10.80mm (No.7) Winder	EACH	<b>£39.95</b>
<b>M48986</b>	Left Hand, Ø12.00mm (No.8) Winder	EACH	<b>£39.95</b>
<b>M48343</b>	Left Hand, Ø18.00mm (No.14) Winder	EACH	<b>£39.95</b>
<b>M40221</b>	Right Hand, Ø6.00mm (No.1) Winder	EACH	<b>£39.95</b>
<b>M40222</b>	Right Hand, Ø7.80mm (No.4) Winder	EACH	<b>£39.95</b>
<b>M45756</b>	Right Hand, Ø9.80mm (No.6) Winder	EACH	<b>£39.95</b>
<b>M37765</b>	Right Hand, Ø10.80mm (No.7) Winder	EACH	<b>£39.95</b>
<b>M37766</b>	Right Hand, Ø12.00mm (No.8) Winder	EACH	<b>£39.95</b>
<b>M48357</b>	Right Hand, Ø18.00mm (No.14) Winder	EACH	<b>£39.95</b>

# MARKING & SCORING

## Centre Punch



### Centre Punch Tool - Pack of 3

A center punch is used to mark the center of a point. It is usually used to mark the center of a hole when drilling holes.

A drill bit has the tendency to 'wander' if it does not start in a recess. A center punch forms a large enough dimple to 'guide' the tip of the drill bit.

When drilling larger holes and the web of the drill is wider than the indentation produced by a center punch, the drilling of a pilot hole is usually needed.

- Includes sizes 1/32", 1/16", 3/32"
- Heat treated with steel alloy finishing
- Knurled soft rubber body for secure grip

Weight: 160g

Code	Description	UOM	Price
<b>P33512</b>	Centre Punch Set	PACK*3	<b>£2.50</b>

## Centre Punch, Adjustable



### Centre Punch Tool - Adjustable

- Adjustable Power Handle for Light or Heavy Punch
- Easy to Grip and Easy to Use
- Knurled Brass Body
- Hardened Steel Point
- Approximately 125mm (5") Length by Ø15mm (5/8")
- Fits into Holster, Jump Kit, Tool Boxes etc.

### Directions:

- Place Point on Surface
- Press Down on Handle Until it Clicks
- Turn Clockwise or Counter Clockwise to Control Depth of Punch

Code	Description	UOM	Price
<b>P34521</b>	Centre Punch, Adjustable	EACH	<b>£4.95</b>

## Centre Punch, Heavy Duty



### Centre Punch Tool - Heavy Duty

- Easy to grip and easy to use
- Heavy duty
- Spring loaded
- Knurled steel body
- Hardened steel point
- Approximately 135mm (5") Length by Ø15mm (5/8")
- Fits into holster, jump kit, tool boxes etc
- Weight: 100g

Code	Description	UOM	Price
<b>S39277</b>	Centre Punch, Heavy Duty	EACH	<b>£4.95</b>

## Centre Punch, Wooden Handle



### Centre Punch Tool - Wooden Handle

- Knurled wooden handle for easy and comfortable gripping
- Hardened Steel Point
- Simple & Effective
- With protective plastic cap

### Dimensions

- Overall length: 165mm
- Handle diameter: Ø35mm

Code	Description	UOM	Price
<b>P37134</b>	Centre Punch, Wooden Handle	EACH	<b>£4.30</b>

+

Contact & Services

Your direct line to our Management Team

## Dividers

Dividers

- Great for marking circles and shapes on various metals such; as gold, silver, platinum, copper, brass etc
- Use also to measure distances from one point to another

D9472

- Max span 100mm
- Manufactured from a best-grade steel
- Well finished and furnished with a solid adjusting nut for fine setting
- The legs are flat, very durable and pivot on a hardened stud
- The flexible bow spring is exceedingly strong to assure reliability
- Steel points are ground down and meet together for accuracy
- Made in Germany

S39283 & S39284

- Max span 80mm & 115mm
- Sharp, fine points
- The flexible bow spring is exceedingly strong to assure reliability
- Knurled handle
- Manufactured from top grade steel
- Made in India

## 80mm Span Divider

- Max span 80mm
- Sharp, fine points
- The flexible bow spring is exceedingly strong to assure reliability
- Knurled handle
- Manufactured from top grade steel
- Made in India



Code	Description	UOM	Price
S39283	80mm Span Divider	EACH	£2.95

## 100mm Span Divider, German

- Span 100mm Maximum
- Manufactured from a best-grade steel
- Well finished and furnished with a solid adjusting nut for fine setting.
- The legs are flat, very durable and pivot on a hardened stud.
- The flexible bow spring is exceedingly strong to assure reliability
- Steel points are ground down and meet together for accuracy
- Great for marking circles and shapes on various metals such as gold silver platinum copper brass etc
- Use also to measure distances from one point to another
- German manufacture



Code	Description	UOM	Price
D9472	100mm Span Divider, German	EACH	£4.95



## 115mm Span Divider

- Max span 115mm
- Sharp, fine points
- The flexible bow spring is exceedingly strong to assure reliability
- Knurled handle
- Manufactured from top grade steel
- Made in India



Code	Description	UOM	Price
S39284	115mm Span Divider	EACH	£3.95

## Engineers (Blue) Marking

Engineers (Blue) Marking

The Original Stuarts Micrometer Blue, Engineers Marking Blue.



Engineer's Blue is a highly pigmented paste used to assist in the mating of two or more components.

- Normally known as Engineers Blue, this thick blue grease which is used as a thin even smear so when two parts are fitted together the area of contact is marked by the transference of the blue colour.
- When Engineer's blue is mixed with methylated spirits (Code C4357) it forms a quick drying stain which is known as marking blue or layout dye. This stain is used in the marking out operation in metalworking with various tools.

Supplied in a 38g tin.  
Weight: 100g

Code	Description	UOM	Price
M33506	Micrometer Engineers Marking Blue	EACH	£3.30

## External Joint Calipers

Calipers - Joint - External

This caliper is used to measure the external diameters of objects of all shapes. Simply adjust the caliper so both points touch the two ends you would like to measure and make a reading of the two points with a rule (code: R4911).



- Made from carbon steel
- Polished finish
- Heat treated points
- Quick adjusting spring nut for speedy and positive setting
- "Faithfull" brand quality tool

Weight: 60g

Code	Description	UOM	Price
C33505	75mm External Joint Caliper	EACH	£3.25

PRICE PROMISE GUARANTEE

Repose / Chasing Hammers

See Page 908



## Internal Joint Calipers

Calipers - Joint - Internal

This gauge is used for taking the internal diameters of objects of all shapes. Simply adjust the caliper so both points touch the two ends you would like to measure and make a reading of the two points with a rule (code: R4911).



- Made from carbon steel
- Polished finish
- Heat treated points
- Quick adjusting spring nut for speedy and positive setting
- "Faithfull" brand quality tool

Weight: 60g

Code	Description	UOM	Price
C33504	75mm Internal Joint Caliper	EACH	£3.50

## Jenny Calipers

Calipers - Jenny

Fixed points 'Jenny' or 'Hermaphrodite' callipers are specifically designed to locate the centre of a round or square section of metal, and are also used for marking off a constant distance from an edge.

The offset leg holds an adjustable point and the straight leg features an integral locating lug.



- "Faithfull" brand quality tool
- 150mm
- Weight: 90g

Code	Description	UOM	Price
C33503	Jenny Calipers	EACH	£4.65

## Scribers

Scribers

- Used for all types of metals including gold and silver
- Made to precision these tools come with hardened steel/carbide tips

## Scriber & Burnisher



Scriber & burnisher combined

- Scriber
- Burnisher
- Stainless Steel
- Overall length 180mm

Code	Description	UOM	Price
B38764	Scriber & Burnisher	EACH	£1.75

## Scriber, Carbide Tip



This Carbide Scriber is a great choice for both manufacturer and hobbyists. The durable etching point works effortlessly on various materials

- Works easily on metals, ceramics and glass.
- Great for jewellery makers, crafts person, engineers, watch and clock makers, arts / crafts and ceramic industry



- Carbide point makes precise marks and last long in sharpness then covenantal steel scribers
- Knurled steel handle provides precision grip

Code	Description	UOM	Price
S6243	Scriber, Carbide Tip	EACH	£2.95

## Scriber, Carbide Tip - Twisted Handle



This Carbide Scriber is a great choice for both manufacturer and hobbyists. The durable etching point works effortlessly on various materials

- Works easily on metals, ceramics and glass.
- Great for jewellery makers, crafts person, engineers, watch and clock makers, arts / crafts and ceramic industry
- Carbide point makes precise marks and last long in sharpness then covenantal steel scribers
- Twisted steel handle provides precision grip
- Double ended

Code	Description	UOM	Price
S39429	Scriber, Carbide Tip - Twisted Handle	EACH	£1.95

## Scriber, Double Ended



Double ended scriber in plastic wallet

- Knurled handle for better grip
- Double ended, lasts twice as long
- Overall length 100mm

Code	Description	UOM	Price
S37136	Scriber, Double Ended	EACH	£1.95

## Scribers, Set of 3



- Double Ended
- Supplied in plastic wallet
- Length 180mm
- Used for all types of metals including gold and silver
- Made to precision these tools come with hardened steel tips
- All scribers consist of two sharp ground hardened steel points to retain their marking / scoring edge
- Scriber 1: double ended scriber has a knurled centre body to provide a positive grip.

One point is set at a right angle 90° increasing flexibility for marking and scoring

- Scriber 2: double ended scriber has a whole knurled body to provide a grip like holding a pencil. One point is set at right angle 90° increasing flexibility for marking and scoring

- Scriber 3: one dual use scriber has a knife edge at one end and is pointed at the opposite end. The knife edge is ideal for scoring wood, plastics and laminates

Code	Description	UOM	Price
S31911	Scribers, Set of 3	PACK*3	£3.95

## Squares for Precision Marking

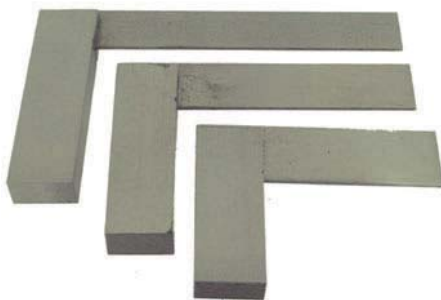

Squares

- Precision Marking Squares are used to mark out the body of your piece and to achieve straight lines
- Milled to an exact 90° angle
- These precision squares are ideal for marking perfect corners, centralising stones and finding centres
- Compact and rigid, they are made with carbon steel

Code	Description	UOM	Price
S20127	50mm (2" inch) Square	EACH	£2.95
S20128	75mm (3" inch) Square	EACH	£3.50
S20129	100mm (4" inch) Square	EACH	£3.95

# MATS

Work mats are a very handy addition to your work bench as using one will give you a clean, smooth and even surface for you to work on.

- Anti skid, anti static, flexible, plastic, rubber, ridged or extra thin all available
- A\*F Swiss, Bergeon Swiss, Horotec Swiss or Cousins
- Adhesive or non adhesive backs
- Protects your work bench
- Helps prevent parts from being lost (there is less bounce off a softer work surface than a hard wooden bench)

## Anti-Skid, Bergeon 7808



Bergeon 7808 - Swiss Made

The same stability as an adhesive backed matt, with the flexibility of a normal mat. A choice of colours gives the user the ability to pick which contrast suits his work best.

- Specialist anti-skid surface
- Slightly soft and flexible
- Black, green or white, offering different contrasts to suit the user
- Bergeon Swiss
- 320 x 240 x 2mm

Code	Description	UOM	Price
M38989	Anti Skid Bench Mat, Black	EACH	£20.95
M38990	Anti Skid Bench Mat, Green	EACH	£20.95
M38988	Anti Skid Bench Mat, Black	EACH	£20.95

## Anti-Static, A&F & Cousins



Anti Static Bench Mats - Cousins or A\*F Swiss

- Anti static mats
- A\*F Swiss or Cousins
- Green
- 235 x 350mm

Code	Description	UOM	Price
M33334	235 x 350mm, A*F Swiss	EACH	£8.95
M35429	235 x 350mm, Cousins	EACH	£5.50
M35099	235 x 350mm, Cousins (adhesive backed)	EACH	£6.25

## Flexi Mats, Bergeon 7050



Flexi-Mats - Bergeon Swiss

- Black
- Excellent grip
- Soft & smooth
- Non adhesive back
- Easy to clean with a humid towel
- Bergeon Smile line
- Bergeon 7050-8500-1 & 7050-8500-2

Code	Description	UOM	Price
M39297	295 x 180mm, Flexi-Mat	EACH	£10.95
M39298	600 x 370mm, Flexi-Mat	EACH	£17.50

## Plastic (Original), Bergeon 6808



Bergeon 6808 - Swiss Made

- Plastic bench mats
- With self adhesive backing
- Black, green or white, offering different contrasts to suit the user
- 240 x 320mm

Code	Description	UOM	Price
M45933	Black Plastic Mat, Bergeon Swiss	EACH	£9.75

**Watchmakers  
Benches**  
See Page 647

M0964	Green Plastic Mat, Bergeon Swiss	EACH	£9.75
M45934	White Plastic Mat, Bergeon Swiss	EACH	£9.75

**Plastic (Original), Horotec**



New from Horotec, specialised super thin bench mats

- Super thin
- Inexpensive
- Sticky back without adhesive
- Great for those who prefer a harder surface
- Ideal for for apprentices, students or employees
- Flexible
- Can be glued to bench if required
- Black, green or white, offering different contrasts to suit the user
- 350 x 240 x 0.5mm
- Horotec Swiss 24.206

Code	Description	UOM	Price
M44133	Black Super Thin Mat, Horotec Swiss	EACH	£5.25
M44135	Green Super Thin Mat, Horotec Swiss	EACH	£7.25
M44134	White Super Thin Mat, Horotec Swiss	EACH	£7.25

**Rubber (Original), Bergeon 5808**



Bergeon 5808 (&2746) - Swiss Made

- Rubber bench mats
- Bergeon 5808 (&2746)
- Black, Green or White
- Self-adhesive
- Sticks to any work bench
- Dimensions: 240 x 340 x 2.0mm

Code	Description	UOM	Price
M48097	Black Bench Mat	EACH	£29.95
M48096	Green Rubber Mat	EACH	£29.95
M0963	Green Rubber Mat (Bergeon 2746)	EACH	£26.50
M48098	White Bench Mat	EACH	£29.95

**Battery Exchange Parts Kit**



**See Page 210**

**Ridged Bench Mats**

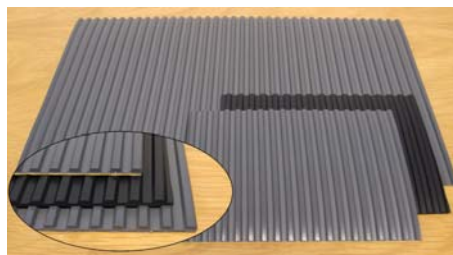

Bench Mats (Ridged)

- Adhesive Backed\*
- Sticks to any work bench
- Stops tools rolling on the workbench

Code	Description	UOM	Price
M31429	100 x 150mm, A*F Swiss	EACH	£9.95
M0966	100 x 150mm, Bergeon Swiss, Adhesive Back*	EACH	£13.30
M31400	180 x 300mm, A*F Swiss	EACH	£16.95
M0965	180 x 300mm, Bergeon Swiss, Adhesive Back*	EACH	£27.50
M35084	200 x 290mm, Indian	EACH	£5.95

**MEASURING GUAGES, BEAD, PEARL & STONE**

- For Wedding & Gem Ring Gauges see Main Tools Category "Ring (Gem & Wedding) Tools"
- For Bangle & Bracelet Gauges see Main Tools Category "Bangle & Bracelet Tools"

**Pearl & Stone (Thickness) Gauge**



- Pearl & Stone (Thickness) Gauge
- 25mm capacity
- Accuracy to 0.01mm
- Millimeter or inch display
- Spring loaded gauge
- Excellent for measuring stones
- 90mm overall length
- Switchable metric/imperial zero button
- Battery operated
- Supplied in carry case

Code	Description	UOM	Price
G44830	Pearl & Stone (Thickness) Gauge	EACH	£59.95

**TODAY SAME DAY DISPATCH**

**SECURE ONLINE ORDERING** 

**IMPROVED SPEED SEARCH** 

**Pearl & Stone Gauge, A\*F Swiss**



Simply put your gemstone between the sizing press and the dial will show your size. The A\*F Pearl and Stone Gauge is a light, compact and handy tool so you can hang it from your neck or from your pocket.

- 0.1 to 20mm in 0.1mm increments
- Spring loaded measuring plunger and anvil
- Movable zeroing dial
- Cast smooth iron body
- Long lasting steel jaws
- Made in Japan

Code	Description	UOM	Price
M4186	Pearl and Stone Gauge, A*F Swiss	EACH	£82.95

**Pearl & Stone Gauge, Indian**



Simply put your gemstone between the sizing press and the dial will show your size

- 0.1 to 10mm in 0.1mm increments
- With locking nut
- Movable zeroing dial
- Cast iron body
- Long lasting steel jaws

Code	Description	UOM	Price
G36254	Pearl and Stone Gauge	EACH	£14.95

**PRICE PROMISE GUARANTEE** 

**Tenth Gauge (for Gem Stones)**



- Tenth gauge for precise measurements of stones etc.
- Accurate to 0.1mm (range 10mm).

Code	Description	UOM	Price
G8869	Stone Gauge, A*F Swiss	EACH	£31.35
G31918	Stone Gauge, Indian	EACH	£5.95

**Carat Gauge (Circle Shape)**



A versatile mounting and stone gauge. It has holes for measuring loose stones and extensions for gauging stones that are ready mounted. Markings are in carat sizes on one side and millimetres on the other.

- Very convenient tool and it is pocket sized to carry with you
- One side carats 1/32 to 4 and other millimetres 2 to 11
- Lightweight aluminium construction
- Size: Ø4" Diameter

Code	Description	UOM	Price
G8680	Carat and Millimeter Gem Gauge	EACH	£2.75

**Carat Gauge (Oval Shape)**



- Diamond Metal Sizing Plate
- Compact, 55mm width
- Polished finish
- 17 carat sizes: 0.01, 0.02, 0.05, 0.10, 0.20, 0.25, 0.50, 0.75, 1.00, 1.20, 1.50, 1.75, 2.0, 2.5, 3.0, 3.5, 4.0ct

Code	Description	UOM	Price
G45825	Carat Gauge	EACH	£2.95

**Carat Gauge (Rectangle Shape)**



- Diamond Metal Sizing Plate
- Compact only 85mm x 25mm
- Polished finish
- 17 carat sizes: 0.01, 0.02, 0.05, 0.10, 0.20, 0.25, 0.50, 0.75, 1.00, 1.20, 1.50, 1.75, 2.0, 2.5, 3.0, 3.5, 4.0

Code	Description	UOM	Price
G6112	Single Arm Metal Diamond Gauge	EACH	£2.10

**Carat Gauge, Turntable**



- This handy aluminium stone gauge measures stones and settings
- From 1/32 to 4 carats or 2 - 11mm
- Features red numerals for easy identification
- Birthstone chart on the back
- 90 x 70mm

Code	Description	UOM	Price
G36255	Carat and Millimeter Gem Gauge	EACH	£1.95

**Carat Fan Gauge**



- Cousins UK Four Arm Diamond Gauge.
- 21 hole - Carat sizes are: 0.01, 0.02, 0.05, 0.10, 0.20, 0.25, 0.50, 0.75, 1.0, 1.25, 1.5, 1.75, 2.0, 2.5, 3.0, 3.5, 4.0, 4.5, 5.0, 5.5, 6.0
  - Made from durable metal polished finished and with a plastic wallet
  - Compact only 90mm folded

Code	Description	UOM	Price
G6111	Multi Arm Metal Diamond Gauge	EACH	£4.50

**Carat Fan Gauge, Bergeon**



- Bergeon 1989.4 - Swiss made
- Four Arm Diamond Gauge
  - Made with excellence in mind
  - 21 hole - Carat sizes are: 0.01, 0.02, 0.05, 0.10, 0.20, 0.25, 0.50, 0.75, 1.0, 1.25, 1.5, 1.75, 2.0, 2.5, 3.0, 3.5, 4.0, 4.5, 5.0, 5.5, 6.0
  - Made from durable metal polished finished and with a plastic wallet
  - Compact only 90mm folded

Code	Description	UOM	Price
G0699	Bergeon 1989-4 Multi Arm Metal Diamond Gauge	EACH	£32.65

**MEASURING GAUGES, CARAT & GEM**

- For Wedding & Gem Ring Gauges see Main Tools Category "Ring (Gem & Wedding) Tools"
  - For Bangle & Bracelet Gauges see Main Tools Category "Bangle & Bracelet Tools"
- Large selection of gem gauges available Swiss and non Swiss. A Simple and inexpensive gauge is exactly what you have been waiting for, and will save you lots of precious time and money.
- Get a real close estimate of a diamond or gemstones carat weight, while they are still in its setting
  - Removing diamonds just to know their carat weight is a thing of the past
  - We stock electronic and dial gauges giving fast accurate readings for your gemstones/pearls

**Carat Gauge**



- A versatile stone gauge for professional jewellers. Can be used to measure mounted and unmounted gemstones, negating the need for diamond scales
- Very convenient tool with a pocket sized carry case
  - Can measure mounted or unmounted stones
  - Perfect for valuations
  - The gauge measures the stone, the book converts the measurement to give the carat weight
  - Can measure diamonds from 0.18 to 11.31 carats

Code	Description	UOM	Price
G39458	Carat Gauge and Guide	EACH	£7.95

**SECURE ONLINE ORDERING**

Stone Setting Claw & Prong Lifting Tool



See Page 1030

Precious Metal Testing  
See Page 716

www. Online Discounts

**Carat Fan Gauge, Multi Shape**



Multi shaped gem fan gauges are a must for people buying used/second-hand jewellery or general stone valuing.

- Simple to use.
- Will measure: round brilliant (0.01ct to 6.0ct), pear (10ct to 30ct), oval (0.75ct to 3.0ct) marquise (0.75ct to 3.0ct), emerald (0.02ct to 3.00ct) and radiant (0.02ct to 3.0ct)
- Measures loose and mounted
- Made from durable metal polished finished and with a plastic wallet
- Compact only 90mm folded

Code	Description	UOM	Price
G20126	Carat Gem Gauge	EACH	£6.95

**Carat Fan Gauge, Multi Shape, Circular**



- Diamond/pearl stone pocket gauge folds to the size 35mm
- Easily measure the size of round marquise, and baguette stones
- Lightweight aluminium

- Sizes:
- Round 0.10 to 2.10mm
  - Baguette 0.60 to 4.00mm
  - Marquise 0.05 to 0.30mm

Code	Description	UOM	Price
G8679	Diamond / Stone Fan Gauge, Circular	EACH	£1.95

**Diamond Estimator Gauge, Gem-A**

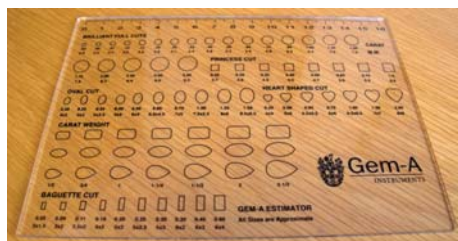

Diamond estimator gauge

Simply lay your stone over the gauge and you can quickly and easily tell the shape, carat and weight of your diamond.

- Gauges brilliant full cuts, princess, oval, baguette & heart shaped cuts
- Includes carat weight estimator
- Gem-A instruments

Code	Description	UOM	Price
G45773	Diamond Estimator Gauge	EACH	£4.95

**Diamond and Pearl Gauge**

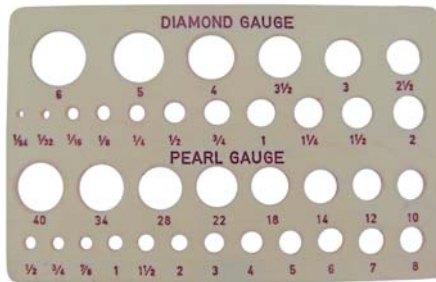

- Cousins UK Popular plastic diamond & pearl gauge
- Two sided with 4 size formats marked.
  - One side Diamond 1/64 to 6 – Pearl 1/2 to 40
  - Other side metric carats 0.016 to 2.56 – metric grains 518 to 41.06

Code	Description	UOM	Price
G6113	Plastic Diamond and Pearl Gauge	EACH	£1.50

**Diamond Simulant Gauge, Shapes**



Diamond Carat - Simulant Shaping - Fan Gauge

This gauge shows examples of 7 beautiful shaped simulated stones. The customer can hold it up to their hands and see what the different shape stones look like without you having to get your expensive stock out.

- Use this diamond gauge to help show what shape diamond a customer might want
- Also nice to use when designing jewellery
- Multiple shaped stones that are attached in one handy tool that store under a sleeve
- A great jewellery tool for stone setting
- Made from durable steel polished chrome finish
- Compact, only 100mm folded
- 7 fan arms
- Supplied with leather case

Shapes include:

- Oval, emerald, pear, marquise, round, square & baguette

Code	Description	UOM	Price
G47047	Shaped Stone Gauge	EACH	£26.95

**Diamond Simulant Gauge, Sizes**



Diamond Carat - Simulant Sizing - Fan Gauge

This gauge shows examples of ten beautiful round simulated stones. The customer can hold it up to their hands and see what the different size stones look like without you having to get your expensive stock out.

- Use this diamond gauge to help show what size diamond a customer might want.
- Also nice to use when designing jewellery.
- Multiple sized stones that are attached in one handy tool that store under a sleeve.
- A great jewellery tool for stone setting.
- Made from durable steel polished chrome finish
- Compact only 100mm folded

- 10 fan arms with each are embossed with weight and sizes:

Sizes as follows..

- 0.10ct - Ø3.0mm, 0.15ct - Ø3.4mm, 0.20ct - Ø3.8mm
- 0.25ct - Ø4.2mm, 0.33ct - Ø4.6mm, 0.50ct - Ø5.2mm
- 0.75ct - Ø6.0mm, 1.00ct - Ø6.6mm, 1.50ct - Ø7.5mm
- 2.00ct - Ø8.2mm

Code	Description	UOM	Price
G20149	Diamond Sizing Gauge	EACH	£26.95

**Diamond Sieve & Bead Sorter**



Diamond sieves are used as a simple solution for sorting rough or polished diamonds.

- Can also be used to sort out gemstones, beads, and crystals
- Precision-drilled sieves fit inside the chrome plated case and screens diamonds by size
- 23 plates
- 50mm diameter
- Sorting tub for collection
- Capacity 1 - 33 points (Ø1.10 to Ø4.50mm)
- Sieve interchangeability Chart

Select your required plate and insert between the two halves, then use as a sieve to separate sizes.

Code	Description	UOM	Price
S9479	Diamond Sieve Set	EACH	£29.50

**Gem Setting Gauge**

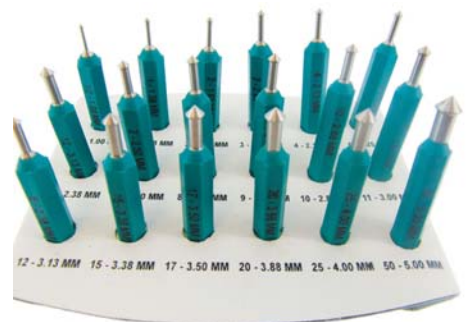

- Comprising of 18 conical gem gauges
- Each hardened steel with blue plastic handles
- Marked in mm 1 to 5
- Carat points 1/2 to 50 for checking the size of the stone seat
- (Carat point) sizes include: 1.00mm (1/2), 1.38mm (1), 1.63mm (2), 2.00mm(3), 2.13mm (4), 2.25mm (5), 2.38mm (6), 2.50mm (7), 2.63mm(8), 2.75mm(9), 2.88mm (10), 3.00mm (11), 3.13mm (12), 3.38mm (15), 3.50mm (17), 3.88mm(20), 4.00mm(25), 5.00mm(50)

# MEASURING GAUGES, MICROMETERS, RULERS & VERNIERS

Stone gauge with 18 holes marked in both points and millimetres (1/2 50 points 1-5mm).

The unit consists of 18 gauges in the sizes for measuring the cut for the stone to sit in.

Setting burrs (ref: 119257 and size) with a 90 degree angle are available for cutting a perfect seat corresponding to the measured size of the gem setting gauge.

Code	Description	UOM	Price
G19551	Gem Setting Gauge	EACH	£129.95

## MEASURING GAUGES, MICROMETERS, RULERS & VERNIERS

### CLOCK KEY GAUGE

#### Clock Key Gauge



- Metric Sizes: 1.75mm to 6.00mm
- Imperial Numbers: 000 to 15
- 18 Sizes

Code	Description	UOM	Price
G32018	Clock Key Gauge	EACH	£12.95

### MICROMETERS

The micrometre is a precision measuring instrument used by jewellers, watchmakers, clockmakers, engineers and any work that deals in precision measurements

- Manual or digital
- 0.01mm (one hundredth of a millimetre) precision
- Each revolution moves the face closer to the anvil
- Essential for any workbench

#### Micrometers

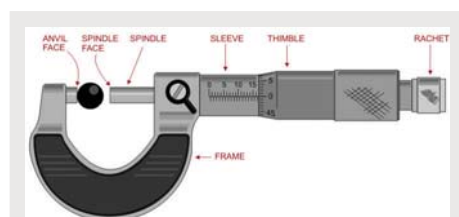

- ETALON Swiss, Bergeon Swiss, Baker or unbranded
- Measuring 0 to 25mm

- Measuring in graduations of 0.01mm
- See additional information for specifications

#### Precision Micrometer (0 to 15mm)



- Metal
- Measures 0 to 15mm in graduations of 0.01mm
- Knurled handle
- Steel

Code	Description	UOM	Price
M47755	Precision Micrometer (0 to 15mm)	EACH	£4.75

#### Precision Micrometer (0 to 25mm)



- Metal
- Measures 0 to 25mm in graduations of 0.01mm

Code	Description	UOM	Price
M6253	Precision Micrometer (0 to 25mm)	EACH	£5.75

#### Precision Micrometer, Baker (0 to 25mm)



- Measures 0 to 25mm in graduations of 0.01mm
- Carbide tipped
- Ground & lapped finished measuring faces
- Stainless steel for rust prevention
- Laser etched markings
- Heat resistant grip
- Supplied with case

Code	Description	UOM	Price
G45824	Precision Micrometer, Baker (0 to 25mm)	EACH	£34.95

#### Precision Micrometer, ETALON (0 to 25mm)



- Measures 0 - 25mm in graduations of 0.01mm
- Tungsten Carbide Tip
- Heat Insulated Handle
- Supplied in plastic case
- ETALON Swiss

This is a beautiful engineered micrometer made by Etalon (ISO 9001) established in 1941, and based in Rennes, Switzerland

- Complete with 2 hex keys and adjusting spanner wrench for fine tuning your precision instrument
- Every Etalon micrometre is inspected for accuracy and an inspection report is provided according to EN45014

Code	Description	UOM	Price
G35101	Precision Micrometer, ETALON (0 to 25mm)	EACH	£59.95

#### Tavannes Horizontal Micrometer, Bergeon (0 to 25mm)



- Measures 0 to 25mm in graduations of 0.01mm
- Bergeon 1959.1423

Code	Description	UOM	Price
M31444	Tavannes Horizontal Micrometer, Bergeon (0 to 25mm)	EACH	£575.00

### Micrometers (Digital)

#### Digital Micrometer



Code	Description	UOM	Price
G44357	Digital Micrometer	EACH	£51.95

### MEASURING GAUGES

#### Degree Gauge



Spring loaded measurement gauge

- Blackened steel arms
- Brass measurement run
- Accurate to 1/10 mm
- Up to 15mm

Code	Description	UOM	Price
G39457	Degree Gauge	EACH	£6.95

**SECURE** **ONLINE ORDERING**

### Depth Gauge with Protractor



A handy tool that allows the angle and depth to be measured simultaneously. The protractor graduates in 10° increments between 0 - 180° in opposite directions permitting the reading of both the direct and supplementary angles, all markings are deeply embossed.

The rule is graduated in both imperial and metric dimensions up to 150mm/6" and a knurled thumb nut allows the rule to be locked at the chosen angle.

- Blade Length 150mm (6")
- Graduations: 0.5mm or 64ths
- Weight: 90g

Code	Description	UOM	Price
G33510	Depth Gauge with Protractor	EACH	£7.45

### Rulers



Measuring with accuracy is a given for the day to day running of any retailer or manufacturer worth his salt. Here is a selection of the finest measuring aids available.

Metric measurement was introduced to Britain in the late 1960's and by early 70's it became a standard unit of measure and is the most popular today. Imperial however, still crops up as a measurement from all parts of the world with many manufactures and traders still using it so you still do have to be familiar with the system.

Our selection of measuring tools have both, so you can convert from either measurement with ease.

Code	Description	UOM	Price
R4912	150mm (6") Steel Ruler	EACH	£1.15
R1469	150mm (6") Steel Ruler, Bergeon Swiss	EACH	£8.50
R4911	300mm (12") Steel Ruler	EACH	£1.95
R31447	L-Shaped Ruler 75mm x 100mm (3" x 4")	EACH	£6.75

#### Centre Punch Set

See Page 920

### Wire Diameter Gauge



Convenient, round, light weight pocket gauge for measuring sheet, wire, rod, drills etc, to limit the use of a calliper.

- Ideal for measuring sheet or wire before rolling them through a rolling mill
- Measures burrs and drills faster when stone setting, for example
- All sizes embossed onto the gauge

- G39461
- Metric sizes from 0.19mm to 7.62mm
  - SWG wire gauge numbers 1 to 36
  - Weight: 50g
- G33511
- Metric sizes from 0.19mm to 7.62mm as well as one imperial side
  - SWG wire gauge numbers 1 to 36
  - Weight: 50g

Code	Description	UOM	Price
G39461	Wire Diameter Gauge	EACH	£4.65
G33511	Wire Diameter Gauge, Faithfull Tools	EACH	£11.65

## VERNIER GAUGES

*What is a vernier gauge?  
A plain, dial or digital vernier (or caliper) will give a direct reading of a distance measured, to high degree of accuracy.*

- One of the most useful measuring devices, used for generations in many types of industry
- All are functionally identical, with different ways of reading the result. These calipers comprise a calibrated scale with a fixed jaw, and another jaw with a pointer, that slides along the scale
- The distance between the jaws is then read in different ways for the three types
- Verniers can measure internal dimensions (upper jaws) and external dimensions (lower jaws) and in many cases depth by the use of a probe that is attached to the movable head and slides along the center of the body
- This probe is slender and can get into deep grooves that may prove difficult for other measuring tools
- Many vernier gauges include metric measurements on the lower part of the scale and imperial measurements on the upper, or vice versa
- Verniers differ in their precision of measurement. Most commonly, verniers can measure to within 0.01mm (10 micrometers) or one thousandth of an inch

### Depth Measuring Attachment, Bergeon Swiss



- Depth Measuring Attachment - Bergeon Swiss
- Attaches to a vernier gauge to easily measure depths
  - Acts as a measuring probe
  - Multiple diameter gauges: Ø0.90, 1.40, 1.60, 2.40 & 2.90mm
  - Also includes roller ball gauge to measure evenness of a surface
  - Set of 6 probes
  - Bergeon 7774

Code	Description	UOM	Price
G45952	Depth Gauge Set for Verniers	EACH	£81.95

### Dial (Metal) Vernier



- Metal Vernier Dial Gauge
- Suitable for internal, external and depth measuring
- Stainless steel with dial
- Capacity 150mm
- Made in Germany

Code	Description	UOM	Price
G4771	Metal Vernier Dial Gauge	EACH	£49.95

### Dial (Plastic) Vernier, A\*F Swiss



- A\*F Swiss. Plastic Vernier Dial Gauge Lightweight in toughened polyamide plastic with large metric dial for ease of reading and accuracy. Features locking lever for fixing the interior, exterior and depth measurements. The sliding gauge is marked in cm and the dial is graduated as follows:
- 1.0 = 1mm
  - 0.1 = 1/10mm
  - 0.05 = 1/20mm
  - Capacity = 150mm

Code	Description	UOM	Price
G0700	Plastic Vernier Dial Gauge, A*F Swiss	EACH	£38.15

PRICE PROMISE GUARANTEE

Online Discounts

## Dial (Plastic) Vernier, Bergeon



Bergeon 6621 - Swiss Made

Plastic Vernier Dial Gauge Lightweight in toughened polyamide plastic with large metric dial for ease of reading and accuracy. Features locking lever for fixing the interior, exterior and depth measurements. The sliding gauge is marked in cm and the dial is graduated as follows:

- 1.0 = 1mm
- 0.1 = 1/10mm
- 0.05 = 1/20mm
- Capacity = 150mm

Code	Description	UOM	Price
G0695	Plastic Vernier Dial Gauge, Bergeon	EACH	£37.95

## Digital (Carbon Fibre) Vernier



- Made of extra strong carbon fiber composite.
- The tare button allows the user to zero the gauge at any point during measuring.
- Comprising a large LCD screen and three measuring conversions, millimeter, inches and fractional, measuring values between 0 & 6" (0 - 150mm).
- Internal, external and height dimensions can be easily and accurately measured for a broad range of procedures.
- Triple scale measurement display in 0.1mm, 0.001 inches and 0-6 7/64.
- Flashing display indicates low battery life.

Weight: 80g

Code	Description	UOM	Price
G34125	Carbon Fibre Digital Vernier Gauge	EACH	£19.95

## Digital (Metal) Vernier



For precise and accurate measuring of inner and outer dimensions.

G9737:

- 100mm Digital Vernier Gauge
- Accuracy to 0.01mm
- Only 170mm overall length with measuring capacity of 100mm (4")
- External and internal measurement in accurate increments of 0.01 mm
- Switchable metric/imperial zero button
- Battery operated (replacement battery our code SZ357MF, RN357MF or MX357MF)

G5498:

- 150mm Digital Vernier Gauge
- Accuracy to 0.01mm
- 235mm overall length with measuring capacity of 150mm
- External and internal measurement in accurate increments of 0.01 mm
- Switchable metric/imperial zero button

- Battery operated (replacement battery our code SZ357MF, RN357MF or MX357MF)

Code	Description	UOM	Price
G9737	100mm Digital Metal Vernier	EACH	£19.25
G5498	150mm Digital Metal Vernier	EACH	£19.95

## Digital "Full Screen" (Plastic) Vernier



- The tare button allows the user to zero the gauge at any point during measuring.
- Comprising a large LCD screen and three measuring conversions, millimeter, inches and fractional, measuring values between 0 & 6" (0 - 150mm).
- Internal, external and height dimensions can be easily and accurately measured for a broad range of procedures.
- Triple scale measurement display in 0.01mm, 0.001 inches and 0-6 7/64.
- Flashing display indicates low battery life.
- Supplied in a plastic storage case, battery is included which is a CR2032. Additional batteries are available, our reference MX2032.

Weight: 100g

Code	Description	UOM	Price
G34124	Full Screen Digital Vernier Gauge	EACH	£22.95

## Sliding (Brass) Vernier



- Brass
- Graduated in inches and mm
- Capacity 80 mm (Cousins)
- Fits in pocket

Code	Description	UOM	Price
G31917	Brass Sliding Gauge, Cousins	EACH	£3.95

## Sliding (Metal) Vernier



- Metal Vernier
- Sliding Gauge
- Supplied in plastic pouch
- Imperial and metric
- Measures: 1 to 125mm or 1/16 to 5 inches

Code	Description	UOM	Price
G39460	Metal Vernier Sliding Gauge	EACH	£3.95

## Sliding (Plastic) Vernier



- Plastic Vernier
- Sliding Gauge
- Lightweight, easy to use and transport

- Imperial and metric
- Measures: 1 to 100mm or 1/8 to 4 inches

Code	Description	UOM	Price
G39459	Plastic Vernier Sliding Gauge	EACH	£0.75

## Sliding (Plastic) Vernier, A\*F Swiss

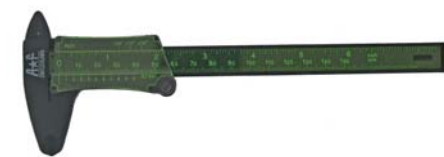

- A\*F Swiss
- Plastic Vernier
- Sliding Gauge
- Lightweight in toughened polyamide plastic with locking lever
- Double jaws for measuring inside and outside as well as depth gauge
- Measures: 0.05 to 150 mm

Code	Description	UOM	Price
G0701	Plastic Vernier Sliding Gauge, A*F Swiss	EACH	£25.50

## WATCH GAUGES

### Crown Gauge

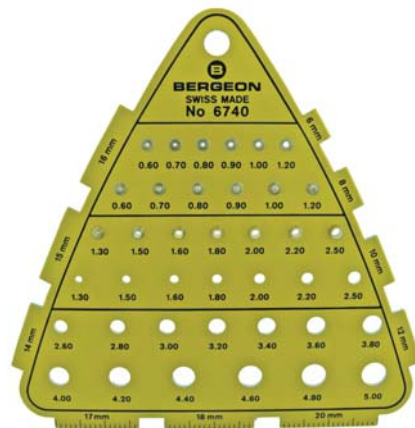

Bergeon 6740

For measuring:

- Thread of Stems
- Threads of Crowns
- Diameters of Crowns
- Diameters of Pendant tubes
- Dimensions: 85 x 85 x 1mm

Also suitable for measuring the distance between the lugs of watch cases.

Code	Description	UOM	Price
G0693	Watch Crown Gauge, Bergeon 6740	EACH	£37.95

### Glass Gauge



Gauge for watch glasses

- Up to 70mm
- Aluminium
- Easy to store and transport
- Great value

Code	Description	UOM	Price
G39462	Watch Glass Gauge, Aluminium	EACH	£0.95

**Hand Gauge**

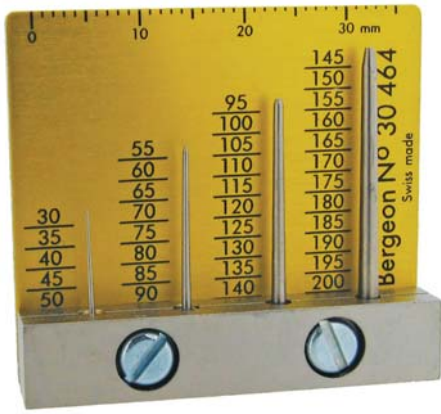

Bergeon 30464

- Accurately measures watch hand holes
- Can also be used for bushes and jewel holes

Code	Description	UOM	Price
G0698	Watch Hand Gauge, Bergeon 30464	EACH	£32.95

**Ligne Gauge (for Watch Movements)**

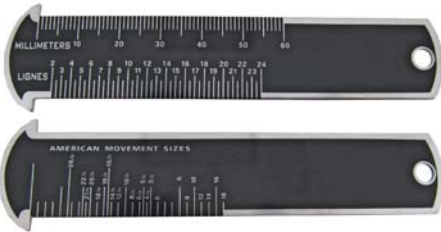

- Black
- Steel
- Between 2 to 24 ligne
- Millimeters 0 to 60mm
- For measuring the size of the watch movements

Code	Description	UOM	Price
G19002	Ligne Gauge	EACH	£2.45

**Spring Bar Gauges**

Callipers for measuring the distance between the lugs of a watch case.

- Both millimetre and inch display
- Millimetres: 8 to 22mm
- Inches: 5/16" to 7/8"
- Bergeon Swiss or Indian

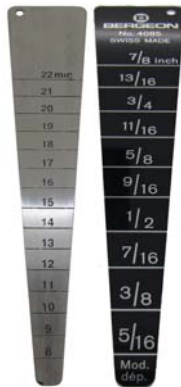

Code	Description	UOM	Price
S39649	Spring Bar Gauge	EACH	£2.95
L0934	Spring Bar Gauge, Bergeon Swiss	EACH	£12.50

**Wrist Watch & Pocket Watch Hands**  
See Page 214

**MOVEMENT HOLDERS (CLOCK & WATCH)**

**CLOCK MOVEMENT HOLDERS**

**Assembly Leg Movement Clamps**

These robustly made Movement Clamp legs hold the job away from the bench to clear protrusions and make inspection, pivot locating and strike assembly much easier.



- 3 pieces
- Solid brass and steel with non-slip feet
- Wired securely the tripod doubles as a temporary wall/ test hanger
- Made in UK

Code	Description	UOM	Price
C6477	Leg Clock Movement Clamps	PACK*3	£11.50

**Assembly Movement Supports**



- Support your clock movement during repair
- Provides easy access to all areas of the movements
- Assortment of sizes and supports
- Legs clamp to each corner of the movement
- Supplied with a hanging bracket for movement testing
- Including clock movement legs

Code	Description	UOM	Price
A41165	Assembly Supports for Clock Movements	EACH	£9.95

**Bench Top, Bergeon 30043**

Clock Movement Holder - Bergeon Swiss - Bench Top

The REALIS clock timing stands are simple, robust and practical. No more waste of time, insecurity, wrong suspension springs. Absolute stability of the movement during timing. Holder made of carefully polished beechwood. It is jointed and adjustable. Clock movements are not held by the bottom but they are hung. This very practical stand will hold all types of round and square movements of current sizes. Height: 360 - 450 mm.



- Bergeon 30043
- Made of beech wood
- Jointed

- Adjustable
- Holds Round or Square Movements
- Various test positions
- Bench Top
- Total height 36 - 45cm

Code	Description	UOM	Price
M0982	Movement Holder (Clock), Bergeon 30043	EACH	£84.95

**Wall Mounted, Bergeon 30044**

Clock Movement Holder - Bergeon Swiss - Wall Mounted

The REALIS clock timing stands are simple, robust and practical. No more waste of time, insecurity, wrong suspension springs. Absolute stability of the movement during timing. Holder made of carefully polished beechwood. It is jointed and adjustable. Clock movements are not held by the bottom but they are hung. This very practical stand will hold all types of round and square movements of current sizes. Height: 360 - 450 mm.



- Bergeon 30043
- Made of beech wood
- Jointed
- Adjustable
- Holds Round or Square Movements
- Various test positions
- For fixing to the wall
- Total height 36 - 45cm

Code	Description	UOM	Price
M0983	Movement Holder (Clock), Bergeon 30044	EACH	£54.95

**Bench Top, Universal**

- Universal Clock Movement Holder
- Strong & robust
- Regulating / Levelling screw on base
- Brackets are adjustable to 11 inches
- Overall height 370mm



Code	Description	UOM	Price
S32057	Mechanical Pendulum Clock Regulating Stand	EACH	£29.95

**Clock Movements**

*Hermle* See Page: 1292

*Kieninger* See Page: 1313

**HUBERT HERR** See Page: 1316

**REGULA** See Page: 1318



## WATCH MOVEMENT HOLDERS

### Ø7mm to 50mm, Plastic Rings

- Movement Holders
- Plastic Rings
- Set of 12
- Diameter: Ø7mm to Ø50mm



Code	Description	UOM	Price
M0984	Ø7mm to Ø50mm Plastic Ring Holders	PACK*12	£2.25

### Adjustable

Adjustable Movement Holders

- Ladies or gents
- Adjustable
- Aluminium
- Knurled handles
- Made in India



Code	Description	UOM	Price
M38222	Ø9mm to Ø23mm Movement Holder	EACH	£2.45
M38221	Ø9mm to Ø65mm Movement Holder	EACH	£3.95

### 3¾ to 11 Ligne, A\*F Swiss

- A\*F Swiss
- Swiss Made
- Adjustable 3¾ to 11 ligne
- Steel Frame



Code	Description	UOM	Price
M0972	3¾ to 11 Ligne, A*F Swiss	EACH	£24.50

### 3¾ to 11 Ligne, Bergeon 4039P - Carbon Fibre

- Bergeon 4039P
- Swiss Made
- Adjustable 3¾ to 11 ligne
- Carbon Fibre Frame



Code	Description	UOM	Price
M32570	3¾ to 11 Ligne, Bergeon 4039P - Carbon Fibre	EACH	£13.95

### 3¾ to 11 Ligne, Bergeon 4039

- Bergeon 4039
- Swiss Made
- Adjustable 3¾ to 11 ligne
- Steel Frame



Code	Description	UOM	Price
M0974	3¾ to 11 Ligne, Bergeon 4039	EACH	£16.50

### 8¾ to 19 Ligne, Bergeon 4040P - Carbon Fibre

- Bergeon 4040P
- Swiss Made
- Adjustable 8¾ to 19 Ligne.
- Carbon Fibre Frame



Code	Description	UOM	Price
M32569	8¾ to 19 Ligne, Bergeon 4040P - Carbon Fibre	EACH	£16.50

### 8¾ to 19 Ligne, Bergeon 4040

- Bergeon 4040
- Swiss Made
- Adjustable 8¾ to 19 Ligne.
- Steel Frame



Code	Description	UOM	Price
M0975	8¾ to 19 Ligne, Bergeon 4040	EACH	£16.50

### Ø25mm to Ø62mm, Bergeon 30211 - Pocketwatch

- Bergeon 30211
- Swiss Made
- Pocket Watch
- Steel Frame



Code	Description	UOM	Price
M32676	Ø25mm to Ø62mm, Bergeon 30211 - Pocketwatch	EACH	£59.95

### By Size, Bergeon 1996



Bergeon 1996 (+ Ligne size) - Swiss Made

- Individual movement holders specific to one ligne size only
- With adjustable hollow centre screw for hand setting support
- Base Ø31mm
- Swiss Made

Code	Description	UOM	Price
M43030	4¾ Ligne Movement Holder	EACH	£34.95
M43031	5 Ligne Movement Holder	EACH	£34.95
M43032	5¼ Ligne Movement Holder	EACH	£34.95
M43033	5½ Ligne Movement Holder	EACH	£34.95
M43034	5¾ Ligne Movement Holder	EACH	£34.95
M43035	6 Ligne Movement Holder	EACH	£34.95
M43036	6½ Ligne Movement Holder	EACH	£34.95
M43037	6¾ Ligne Movement Holder	EACH	£34.95
M43038	7¼ Ligne Movement Holder	EACH	£34.95
M43039	7½ Ligne Movement Holder	EACH	£34.95
M0976	7¾ Ligne Movement Holder	EACH	£34.95
M43040	8 Ligne Movement Holder	EACH	£34.95
M2995	8¾ Ligne Movement Holder	EACH	£34.95
M0977	8¾ Ligne Movement Holder	EACH	£34.95
M43041	9 Ligne Movement Holder	EACH	£34.95
M43042	9¾ Ligne Movement Holder	EACH	£34.95
M43043	9¾ Ligne Movement Holder	EACH	£34.95

M0978	9¾ Ligne Movement Holder	EACH	£34.95
M0979	10¼ Ligne Movement Holder	EACH	£34.95
M43044	10¾ Ligne Movement Holder	EACH	£34.95
M43045	11 Ligne Movement Holder	EACH	£34.95
M43046	11¼ Ligne Movement Holder	EACH	£34.95
M0980	11½ Ligne Movement Holder	EACH	£34.95
M35295	11¾ Ligne Movement Holder	EACH	£34.95
M36112	12 Ligne Movement holder	EACH	£34.95
M43047	12¼ Ligne Movement Holder	EACH	£34.95
M0981	12½ Ligne Movement Holder	EACH	£34.95
M43048	12¾ Ligne Movement Holder	EACH	£34.95
M43049	13 Ligne Movement Holder	EACH	£34.95
M43050	13¼ Ligne Movement Holder	EACH	£34.95
M43051	13½ Ligne Movement Holder	EACH	£34.95
M43052	13¾ Ligne Movement Holder	EACH	£36.95
M43053	14 Ligne Movement Holder	EACH	£36.95
M43054	14¼ Ligne Movement Holder	EACH	£36.95
M43055	15 Ligne Movement Holder	EACH	£36.95
M43056	16 Ligne Movement Holder	EACH	£36.95
M43057	17 Ligne Movement Holder	EACH	£36.95
M43058	17 Ligne Movement Holder	EACH	£36.95
M43059	19 Ligne Movement Holder	EACH	£36.95

### By Size, Bergeon 5914



Bergeon 5914 (+ ligne size) - Swiss Made

- Individual movement holders specific to one ligne size only
- Round shape
- Reversible
- In nickelled brass
- Swiss Made

Code	Description	UOM	Price
M43079	4¾ Ligne Movement Holder	EACH	£24.50
M43080	5 Ligne Movement Holder	EACH	£24.50
M43081	5¼ Ligne Movement Holder	EACH	£24.50
M43082	5½ Ligne Movement Holder	EACH	£24.50
M43083	5¾ Ligne Movement Holder	EACH	£24.50
M43084	6 Ligne Movement Holder	EACH	£24.50
M43085	6½ Ligne Movement Holder	EACH	£24.50
M43086	6¾ Ligne Movement Holder	EACH	£24.50
M43087	7 Ligne Movement Holder	EACH	£24.50
M43088	7½ Ligne Movement Holder	EACH	£24.50
M43089	7¾ Ligne Movement Holder	EACH	£24.50
M43090	8 Ligne Movement Holder	EACH	£24.50
M43091	8¼ Ligne Movement Holder	EACH	£24.50
M43092	8¾ Ligne Movement Holder	EACH	£24.50
M43093	9 Ligne Movement Holder	EACH	£24.50
M43094	9¾ Ligne Movement Holder	EACH	£24.50
M43095	9¾ Ligne Movement Holder	EACH	£24.50
M43096	9¾ Ligne Movement Holder	EACH	£24.50
M43097	10¼ Ligne Movement Holder	EACH	£24.50
M43098	10¾ Ligne Movement Holder	EACH	£24.50
M43099	11 Ligne Movement Holder	EACH	£24.50
M43100	11¼ Ligne Movement Holder	EACH	£24.50
M43101	11½ Ligne Movement Holder	EACH	£24.50
M43102	11¾ Ligne Movement Holder	EACH	£24.50
M43103	12 Ligne Movement Holder	EACH	£24.50
M43104	12¼ Ligne Movement Holder	EACH	£24.50
M43105	12½ Ligne Movement Holder	EACH	£24.50
M43106	12¾ Ligne Movement Holder	EACH	£24.50
M43107	13 Ligne Movement Holder	EACH	£24.50
M43108	13¼ Ligne Movement Holder	EACH	£26.95
M43109	13½ Ligne Movement Holder	EACH	£26.95
M43110	13¾ Ligne Movement Holder	EACH	£26.95
M43111	14 Ligne Movement Holder	EACH	£26.95
M43112	14¼ Ligne Movement Holder	EACH	£26.95
M43113	16 Ligne Movement Holder	EACH	£30.95

PRICE PROMISE GUARANTEE

<b>M43114</b>	16½ Ligne Movement Holder	EACH	<b>£30.95</b>
<b>M43115</b>	17 Ligne Movement Holder	EACH	<b>£30.95</b>
<b>M43116</b>	18 Ligne Movement Holder	EACH	<b>£30.95</b>
<b>M43117</b>	18½ Ligne Movement Holder	EACH	<b>£30.95</b>
<b>M43118</b>	19 Ligne Movement Holder	EACH	<b>£30.95</b>
<b>M43119</b>	19½ Ligne Movement Holder	EACH	<b>£31.85</b>
<b>M43120</b>	22 Ligne Movement Holder	EACH	<b>£31.85</b>

**By Size, Economy**

- Individual movement holders
- Ladies or gents
- Plastic
- Incredible value
- Inexpensive to replace of lost or damaged
- Colour may vary
- Made in India



Code	Description	UOM	Price
<b>M39630</b>	6¾ to 8 Ligne Movement Holder	EACH	<b>£1.50</b>
<b>M39631</b>	10½ to 12 Ligne Movement Holder	EACH	<b>£1.50</b>

**Spring Loaded, Swiss Style**



Movement Holders - Swiss Style

- Spring loaded
- Metal construction
- Ladies or gents

Code	Description	UOM	Price
<b>M39628</b>	Up to Ø15mm (Ladies)	EACH	<b>£4.95</b>
<b>M39629</b>	Up to Ø20mm (Gents)	EACH	<b>£4.95</b>

**Universal, Sprung Loaded**



- Spring loaded universal style
- Nickered steel tubes with black steel ends
- White nylon pins
- Maximum capacity Ø36mm diameter

Code	Description	UOM	Price
<b>M7612</b>	36mm Capacity Sprung Loaded Watch Movement Holder	EACH	<b>£2.95</b>

**for ETA 251.2XX Series**



A\*F - Swiss Made  
Bergeon - Swiss made

Metal or plastic movement holder for hand setting and chronograph function checking.

- 13¼ Ligne
- 4 pushers @ 2h, 4h, 8h & 10h
- See web "more Info" for full specification

Specifically for ETA calibres:

- 251.252
- 251.262
- 251.265
- 251.272

Code	Description	UOM	Price
<b>251252MA</b>	A*F Swiss ETA 251.2XX Series Movement Holder	EACH	<b>£33.95</b>
<b>M44216</b>	Bergeon Swiss ETA 251.2XX Series Movement Holder	EACH	<b>£189.95</b>

**for ETA 251.471**

A\*F 185.137 - Swiss Made

Plastic movement holder for hand setting and chronograph function checking. For calibre ETA 251.471.



- 10½ Ligne
- Movement holder with 2 push pieces
- Specifically for calibre ETA 251.471

Code	Description	UOM	Price
<b>251471MA</b>	ETA 251.471 Watch Movement Holder	EACH	<b>£36.08</b>

**for ETA 2824**

Horotec 09.050.02

Plastic movement holder for movement repair hand setting function checking. For calibre ETA 2824.



- 11½ Ligne
- Green Plastic

Code	Description	UOM	Price
<b>M48226</b>	ETA 2824, Horotec 09.050.02	EACH	<b>£3.00</b>

**for ETA 2892.A2**

Begeon 1999 - Swiss Made

Metal movement holder for hand setting and chronograph function checking. For calibre ETA 2892.A2



- 11½ to 13¼ Ligne
- 4 pushers @ 4h, 8h, 10h & 11h
- 4 support screws in tempered steel

Code	Description	UOM	Price
<b>M44276</b>	ETA 2892.A2 Movement Holder	EACH	<b>£159.95</b>

**for ETA 2892.2 & Omega 1140**

A\*F 185.140.1140 - Swiss Made

Plastic movement holder for hand setting and chronograph function checking. For calibres ETA 2892.2 & Omega 1140.



- Omega 1140
- ETA 2892.2
- 11¼ Ligne
- 2 Pushers

Code	Description	UOM	Price
<b>M12157</b>	Omega 1140 & ETA 2892-2 Movement Holder	EACH	<b>£19.75</b>

**for ETA 2894 & 2894.2**



Horotec 09.010-30 - Swiss Made  
Horotec 09.010-40 - Swiss Made

Metal round watch movement holder with 2 pushers and supports specific for calibres ETA 2894 & 2894.2

- 12½ Ligne
- 2 pushers
- 4 support screws in tempered steel (2894.2)

Code	Description	UOM	Price
<b>M48223</b>	ETA 2894, Horotec 09.010.30	EACH	<b>£159.95</b>
<b>M48224</b>	ETA 2894.2, Horotec 09.010.40	EACH	<b>£174.95</b>

**for Omega 861**

A\*F 185.140.861 - Swiss Made

Plastic movement holder for hand setting and chronograph function checking. For calibre Omega 861.



- Omega 861
- 12 Ligne
- 2 Pushers
- 2 supports

Code	Description	UOM	Price
<b>M12158</b>	Omega 861 Movement Holder	EACH	<b>£27.95</b>

**for Unitas 6497 / 6498**

Horotec 09.010-38 - Swiss Made

Metal round pocket watch movement holder with 2 supports for ETA calibre Unitas 6497 & 6498



- 16½ Ligne
- 2 support screws in tempered steel

Code	Description	UOM	Price
<b>M48222</b>	Unitas 6497/6498, Horotec 09.010.38	EACH	<b>£114.95</b>

**for Valjoux 7750, A\*F Swiss, Plastic**

A\*F 185.139 - Swiss Made

Plastic movement holder for hand setting and chronograph function checking. For calibre Valjoux 7750.



- 13¼ Ligne
- Pushers @ 2h & 4h
- Supports at centre and 12 o'clock

Code	Description	UOM	Price
<b>7750MB</b>	for Valjoux 7750, A*F Swiss, Plastic	EACH	<b>£25.95</b>

**TODAY** SAME DAY DISPATCH

**for Valjoux 7750, A\*F Swiss, Metal**



A\*F 185.141.7750 - Swiss Made

Metal movement holder for hand setting and chronograph function checking. For calibre Valjoux 7750.

- 13¼ Ligne
- Pushers @ 2h & 4h
- Supports at centre and 12 o'clock
- Optional supports available at 6 & 9 o'clock (supplied separately, see codes M40277 & M40276)

Code	Description	UOM	Price
M40275	for Valjoux 7750, A*F Swiss, Metal	EACH	£82.95

**for Valjoux 7750, A\*F Swiss, Metal, Tip Support**



- Tip Support for M40275
- Movement supplied with tips at centre and 12 o'clock
- Pack\*4

Code	Description	UOM	Price
M40276	for Valjoux 7750, A*F Swiss, Metal, Tip Support	PACK*4	£2.95

**for Valjoux 7750, A\*F Swiss, Metal, Space Screw**



- Space Screw for Tip Support for M40275
- Pack\*4

Code	Description	UOM	Price
M40277	for Valjoux 7750, A*F Swiss, Metal, Space Screw	PACK*4	£2.95

**for Valjoux 7750 & 7753, A\*F Swiss, Metal**



A\*F 185.141.7750-53 - Swiss Made

Metal movement holder for hand setting and chronograph function checking. For calibre Valjoux 7750 & 7753

- 13¼ Ligne
- Pushers @ 2h & 4h (for both calibres)

Code	Description	UOM	Price
M40274	for Valjoux 7750 & 7753, A*F Swiss, Metal	EACH	£94.95

**for Valjoux 7750, Bergeon, Metal,**



Bergeon 1998 - Swiss Made

Metal movement holder for hand setting and chronograph function checking. For calibre Valjoux 7750.

- 13¼ Ligne
- Pushers @ 2h & 4h
- Supports at centre and 12 o'clock

Code	Description	UOM	Price
M44215	for Valjoux 7750, Bergeon, Metal,	EACH	£169.95

**for Valjoux 7750 Series, ETA**



- From ETA Switzerland
- Metal movement holder specifically for various Valjoux
- Calibres with up to 3 push-pieces
- Specifically for calibres: 7750, 7751, 7753, 7754, 7757, 7758, 7760, 7765, 7768 & 7770

Code	Description	UOM	Price
7750MA	for Valjoux 7750 Series, ETA	EACH	£331.50

**for Valjoux 7750, Horotec Swiss**



Horotec 09.050.01

Plastic movement holder for hand setting and chronograph function checking. For calibre Valjoux 7750.

- 13¼ Ligne
- Pushers access @ 2h & 4h

Code	Description	UOM	Price
M48227	for Valjoux 7750, Horotec Swiss	EACH	£6.75

**for Valjoux 7750 to 7753, Horia**



Horia - Swiss Made

Super quality metal movement holder for hand setting and chronograph function checking. For calibres Valjoux 7750 & 7753

- 13¼ Ligne
- 6 Pushers
- Multiple support screws

Code	Description	UOM	Price
M48225	for Valjoux 7750 to 7753, Horia	EACH	£475.00

**for Zenith 400 Series & Rolex 4030**



Horia - Swiss Made

Metal movement holder for hand setting and chronograph function checking. For calibre Zenith 400, 410 & 420 & Rolex calibre 4030.

- 6 pushers
- 2 supports

Code	Description	UOM	Price
M40278	Zenith 400 Series Movement Holder	EACH	£365.00

**for Zenith 3019**



A\*F 185.140.3019 - Swiss Made

Plastic movement holder for hand setting and chronograph function checking. For calibre Zenith 3019.

- 13¼ Ligne
- Pushers @ 2h & 4h
- 4 supports

Code	Description	UOM	Price
M13751	Zenith 3019 Movement Holder	EACH	£58.95

OILING TOOLS



When oiling a watch, it is essential to have a tool that provides accuracy as well as the ability to deliver the right quantity of lubricant. Too much oil can be just as bad as too little.

Here on this page you will notice our large range of oiling tools to apply oils to everyday watches as well as the most top quality brands.

- Bergeon oiling tools have been considered the very best for generations and have adapted their designs with smart thinking in mind.
- A\*F Swiss range of oil tools are excellent in quality as a standard everyday use
- We have a selection of Indian made oil tools and for the price, are of a well-made quality ideal for the beginner, learner or student watchmaker

**Automatic Oilers, Bergeon (New Style)**



Automatic Oilers - Bergeon

An automatic oiler is the best tool for any application which requires a precise amount of oil to be carefully deposited.

- New Ergonomic style
- Easy use
- Oil is inside & protected against dust
- Supplied on base
- Capacity 100mm<sup>3</sup>
- Capacity for spare needle in the end (not supplied)

A39007 - Bergeon 7721

Complete set of all 3 automatic oilers, supplied on ergonomic stand

A38400 - Bergeon 7718.1A:

For shock protection devices in watches and balance bearings of all kinds.

A38401 - Bergeon 7719.2A:

For pallets, mechanical parts, oiling spots difficult to reach.

A38402 - Bergeon 7720.5:

For train wheel pivots, cup bearings, everywhere the oiler has to be positioned before depositing oil.

For Bergeon automatic oiler spare parts please see category below.

**Automatic Oiler Set**



- Bergeon 7721
- Includes auto oiler 1A, 2A & 5
- Supplied on ergonomic plastic stand

Code	Description	UOM	Price
A39007	Automatic Oiler Set	PACK*3	£148.95

**Auto Oiler 1A - Bergeon 7718-1A**

- Bergeon 7718.1A
- For shock protection devices in watches and balance bearings of all kinds
- Capacity 100mm<sup>3</sup>



Code	Description	UOM	Price
A38400	Auto Oiler 1A - Bergeon 7718-1A	EACH	£52.95

**Auto Oiler 2A - Bergeon 7719-2A**

- Bergeon 7719.2A
- For pallets, mechanical parts, oiling spots difficult to reach
- Capacity 100mm<sup>3</sup>



Code	Description	UOM	Price
A38401	Auto Oiler 2A - Bergeon 7719-2A	EACH	£52.95

**Auto Oiler 5 - Bergeon 7720-5**

- Bergeon 7720.5
- For train wheel pivots, cup bearings, everywhere the oiler has to be positioned before depositing oil
- Capacity 100mm<sup>3</sup>



Code	Description	UOM	Price
A38402	Auto Oiler 5 - Bergeon 7720-5	EACH	£52.95

**Watch Oils & Greases**  
See Page 1176

**Automatic Oiler Spare Parts (New Style), Bergeon**



Automatic Oilers - Spare Parts - Bergeon Swiss - New Style

Code	Description	UOM	Price
A37073	Metal Tube & Reservoir (No.1 & 5) Bergeon 7718DR	EACH	£16.85
A37074	Metal Tube & Reservoir (No.2A) Bergeon 7719DR	EACH	£18.95
A40003	Needle (No.1A) Bergeon 7718P	EACH	£12.85
A40004	Needle (No.2A) Bergeon 7719P	EACH	£12.85
A40005	Needle (No.5) Bergeon 7720P	EACH	£12.85

**Automatic Oiler Spare Parts (Old Style), Bergeon**



Automatic Oilers - Spare Parts - Bergeon Swiss

Code	Description	UOM	Price
A0023	Metal Tube (No.1A & 5) Bergeon 2718D	EACH	£13.95
A0027	Metal Tube (No.2A) Bergeon 2719D	EACH	£13.95
A0035	Metal Tube (No.15) Bergeon 4744D	EACH	£6.30
A0024	Needle (No.1A) Bergeon 2718P	EACH	£12.95
A0036	Needle (No.15) Bergeon 4744P	EACH	£5.40

**Oilers (Sets)**

**A\*F Swiss Set in Wallet**

- A\*F Swiss
- Set of 5
- Assortment of 5 oilers
- Supplied in wallet



- Contents:
- Super Fine
  - Extra fine
  - Fine
  - Medium
  - Large

Code	Description	UOM	Price
O1051	A*F Swiss Set in Wallet	PACK*5	£7.50

**Bergeon Swiss Box Set**

- Bergeon 30102-4
- Set of 4
- Assortment of 4 oilers
- Partitioned sliding box
- Colour coded



- Contents:
- Extra fine
  - Fine
  - Medium
  - Large

Code	Description	UOM	Price
O1049	Bergeon Swiss Box Set	PACK*4	£13.75

**Bergeon Swiss Carded Set**

- Bergeon 30102-S
- Assortment of 4 oilers
- Supplied on card
- Colour coded



- Contents:
- Extra fine
  - Fine
  - Medium
  - Large

Code	Description	UOM	Price
O1050	Bergeon Swiss Carded Set	PACK*4	£8.75

**Bergeon Swiss Set on Stand**

- Bergeon 31226-A
- Assortment of 4 oilers
- Supplied on heavy duty chrome base
- With 4 pith wood buttons
- Colour coded



- Contents:
- Extra fine
  - Fine
  - Medium
  - Large

Code	Description	UOM	Price
O47449	Bergeon Swiss Set on Stand	PACK*4	£105.95

**Indian Set in Wallet**

- Indian
- Set of 5
- Assortment of 5 oilers
- Supplied in wallet



- Contents:
- Super Fine
  - Extra fine
  - Fine
  - Medium
  - Large

Code	Description	UOM	Price
O31269	Indian Set in Wallet	PACK*5	£4.95

**Oilers (3 in 1) A\*F Swiss**



- Oilers - A\*F Swiss
- 3 in 1 (2 spares in handle)
  - Swiss Made
  - A\*F Swiss

(Fitted pin arrives the wrong way round, simply remove with pliers and fit the correct way round)

- Tip size
- Black\* - 0.18mm Tip
  - Red\* - 0.18mm Tip
  - Blue - 0.24mm Tip
  - Green - 0.45mm Tip
  - Yellow - 0.80mm Tip

\* Choice of colour (tip size the same)

Code	Description	UOM	Price
O1044	Super Fine (Black) Oiler	EACH	£3.75
O1047	Super Fine (Red) Oiler	EACH	£3.75
O1045	Fine (Blue) Oiler	EACH	£3.75
O1046	Medium (Green) Oiler	EACH	£3.75
O1048	Large (Yellow) Oiler	EACH	£3.75

**Oilers (3 in 1) Bergeon**



Oilers - Bergeon Swiss

- Fitted pin arrives the wrong way round, simply remove with pliers and fit the correct way round
- Tip size: 0.18mm

Code	Description	UOM	Price
O7619	Super Fine (Black) Oiler, Bergeon	EACH	£4.25
N7615	Super Fine (Black) Oiler Needle, Bergeon	EACH	£1.05

**Oilers (Ergonomic) Bergeon**



Oilers - Bergeon Swiss

Bergeon Oilers HH (Haute Horlogerie)

High precision needles, in stainless steel, electropolished. Ergonomic handle with coloured rings for identification and perfect grip. Specially adapted for all precision oiling.

- Very good hold of the drop
- Repeatability of the oil's quantity
- Precision of the drop's deposit
- Synthetic handle, antistatic
- Set of 4 our codes O1049 & O1050
- Swiss Made

Tip size

- Black\* - 0.18mm Tip (Bergeon 7013-N)
- Red\* - 0.18mm Tip (Bergeon 7013-R)
- Blue - 0.24mm Tip (Bergeon 7013-B)
- Green - 0.32mm Tip (Bergeon 7013-V)
- Yellow - 0.45mm Tip (Bergeon 7013-J)

\* Choice of colour (tip size the same)

Code	Description	UOM	Price
S32250	Bergeon Set of 4 Ergonomic Watch Oilers	PACK*4	£77.95
S32251	Super Fine (Black) Bergeon Ergonomic	EACH	£19.50
S32252	Super Fine (Red) Bergeon Ergonomic	EACH	£19.50
S32253	Fine (Blue) Bergeon Ergonomic	EACH	£19.50
S32254	Medium (Green) Bergeon Ergonomic	EACH	£19.50
S32255	Large (Yellow) Bergeon Ergonomic	EACH	£19.50

**Moebius Fixodrop Special Bottle**

See Page 1182



**Oilers (Single Blade)**



Oilers - Indian

- Single Bladed Oilers
- Ideal for students
- Indian Made

Code	Description	UOM	Price
O36099	Ø0.20mm (Red) Oiler - Super Fine	EACH	£1.25
O36100	Ø0.22mm (Blue) Oiler - Extra Fine	EACH	£1.25
O36114	Ø0.30mm (Black) Oiler - Fine	EACH	£1.25
O36101	Ø0.40mm (Yellow) Oiler - Medium	EACH	£1.25
O36115	Ø0.50mm (Green) Oiler - Large	EACH	£1.25

**Oil Pots (Multiple Cups)**

**3 In 1 Oil Pot, Indian**

- 3 In 1 Oil Pot Opaque Hard Plastic
- Ø50mm overall
- Lidded
- Sinks: 15, 13 and 11mm



Code	Description	UOM	Price
O7982	3 In 1 Oil Pot, Indian	EACH	£1.95

**3 Pot Oil Stand, Indian**

- Excellent value steel construction
- Three different sized ruby red style plastic reservoirs
- Rubber padded bottom, non-slip and plastic flip covering lid
- With 3 oil nib cleaners



Size: 60 x 45 x 30mm

Code	Description	UOM	Price
O36113	3 Pot Oil Stand, Indian	EACH	£7.50

**4 Pot Oil Stand, Made in France**

- 85 x 40 x 27mm overall.
- Non slip base
- Plastic reservoirs
- Roll top
- Made in France



Code	Description	UOM	Price
O1041	4 Pot Oil Stand, Made in France	EACH	£21.75

**4 Pot Oil Stand, Bergeon Swiss - Die Cast**



- Bergeon 30180A
- Oil cup stand in die cast alloy, sanded
- 90 x 50mm
- 4 red agate reservoirs
  - Ø6mm
  - Ø8mm
  - Ø9mm
  - Ø10mm

Code	Description	UOM	Price
O1035	4 Pot Oil Stand, Bergeon Swiss - Die Cast	EACH	£89.95

**4 Pot Oil Stand, Bergeon Swiss - Polished**



- Bergeon 30180
- Polished finish
- Oil cup stand in polished brass, chromium plated
- 4 red agate reservoirs
  - Ø6mm
  - Ø8mm
  - Ø9mm
  - Ø10mm

Code	Description	UOM	Price
O1036	4 Pot Oil Stand, Bergeon Swiss - Polished	EACH	£249.95

**4 Pot Oil Stand, Swiss Style**



- 4 oil pot stand, Swiss style
- 4 red agate reservoirs
- Heavy metal oil cup stand & lids
- High quality
- With pith wood holder
- 90 x 50 x 20mm

Code	Description	UOM	Price
O39557	4 Pot Oil Stand, Swiss Style	EACH	£35.95

**Watch Oils**

See Page 1182



### Oil Pots (Single Cups) A\* F Swiss

Oil Pots - Singles - Swiss

- A\* F Swiss
- Synthetic material
- Colour coded

Dimensions:

- Well diameter (colour)

#### Ø9mm (Red) Oil Cup, A\*F Swiss



- Ø45mm overall
- Lid
- Ø9mm sink

Code	Description	UOM	Price
01037	Ø9mm (Red) Oil Cup, A*F Swiss	EACH	£22.95

#### Ø11mm (Blue) Oil Cup, A\*F Swiss



- Ø45mm overall
- With Lid
- Ø11mm sink

Code	Description	UOM	Price
07616	Ø11mm (Blue) Oil Cup, A*F Swiss	EACH	£22.95

#### Ø20mm (Green) Oil Cup, A\*F Swiss



- Ø45mm overall
- With Lid
- Ø20mm sink

Code	Description	UOM	Price
07617	Ø20mm (Green) Oil Cup, A*F Swiss	EACH	£22.95

#### Ø27mm (Yellow) Oil Cup, A\*F Swiss



- Ø45mm overall
- Lid
- Ø27mm sink

Code	Description	UOM	Price
07618	Ø27mm (Yellow) Oil Cup, A*F Swiss	EACH	£22.95

**WORLDWIDE DELIVERY**

**www. Online Discounts**

Hairspring Degreaser Cleaning Fluid

See Page 1167



### Oil Pots (Single Cups) Bergeon Swiss

Oil Pots - Singles - Swiss

- Bergeon Swiss
- Glass wells
- Synthetic material
- Colour coded
- Overall diameter Ø34mm

Dimensions:

- Well diameter (colour)

#### Ø6mm (Red) Oil Cup



Bergeon 6885R - Swiss Made

- Ø34mm
- Lid
- Ø6mm Sink

Code	Description	UOM	Price
047441	Ø6mm (Red) Oil Cup	EACH	£12.95

#### Ø8mm (Blue) Oil Cup



Bergeon 6885B - Swiss Made

- Ø34mm
- Lid
- Ø8mm Sink

Code	Description	UOM	Price
047442	Ø8mm (Blue) Oil Cup	EACH	£12.95

#### Ø10mm (Green) Oil Cup



Bergeon 6885V - Swiss Made

- Ø34mm
- Lid
- Ø10mm Sink

Code	Description	UOM	Price
047443	Ø10mm (Green) Oil Cup	EACH	£12.95

#### Ø12mm (Yellow) Oil Cup



Bergeon 6885J - Swiss Made

- Ø34mm
- Lid
- Ø12mm Sink

Code	Description	UOM	Price
047444	Ø12mm (Yellow) Oil Cup	EACH	£12.95

#### Ø12mm (Grey) Oil Cup



Bergeon 6885G - Swiss Made

- Ø34mm
- Lid
- Ø12mm Sink

Code	Description	UOM	Price
047445	Ø12mm (Grey) Oil Cup	EACH	£12.95

#### Ø12mm (Black) Oil Cup



Bergeon 6885N - Swiss Made

- Ø34mm
- Lid
- Ø12mm Sink

Code	Description	UOM	Price
047446	Ø12mm (Black) Oil Cup	EACH	£12.95

#### Ø27mm (Yellow) Oil Cup



Bergeon 30101D - Swiss Made

- Ø45mm overall
- Lid
- Ø27mm sink

Code	Description	UOM	Price
01040	Ø27mm (Yellow) Oil Cup	EACH	£12.95

PRICE PROMISE GUARANTEE

IMPROVED SPEED SEARCH

Stem Oiler, Bergeon Swiss

See Page 1101



**Oil Pots (Single Cups) Indian**

**Ø8mm (Black) Oil Cup**

- Ø30mm overall
- Lid
- Ø8mm sink



Code	Description	UOM	Price
038659	Ø8mm (Black) Oil Cup	EACH	£1.25

**Ø10mm (Blue) Oil Cup**

- Ø30mm overall
- Lid
- Ø10mm sink



Code	Description	UOM	Price
038660	Ø10mm (Blue) Oil Cup	EACH	£1.25

**Ø11mm (Cream) Oil Cup**

- Ø45mm overall
- Lid
- Ø11mm sink



Code	Description	UOM	Price
07983	Ø11mm (Cream) Oil Cup	EACH	£1.25

**Ø14mm (Green) Oil Cup**

- Ø30mm overall
- Lid
- Ø14mm sink



Code	Description	UOM	Price
038661	Ø14mm (Green) Oil Cup	EACH	£1.25

**Ø17mm (Red) Oil Cup**

- Ø30mm overall
- Lid
- Ø17mm sink



Code	Description	UOM	Price
038662	Ø17mm (Red) Oil Cup	EACH	£1.25

**Moebius 8991, Fixdrop Epilame**

**See Page 1181**



**Oiler Set**



Oiler Set

- Set of 4 oilers & 4 oil cups
- Supplied with wooden stand
- Excellent value

- Oilers included:
- Super Fine (Black)
  - Extra fine (Red)
  - Fine (Blue)
  - Medium (Green)

- Oil cups included:
- Black (Ø8mm)
  - Blue (Ø10mm)
  - Green (Ø14mm)
  - Red (Ø17mm)

Code	Description	UOM	Price
038658	Single Oilers & Cups Set	EACH	£7.50

**Oiler Set, Bergeon 6875**



Oiler Set - Bergeon Swiss

- 5 oilers, 5 oil cups & 5 pith wood buttons
- Agate oil wells
- Anodised aluminium oil cups
- Anodised aluminium oiler handles
- High quality in anodized aluminium base
- Rotating base with bronze bearings
- Colour coded oilers, cups & pith woods
- Bergeon 6875

- Includes:
- Ø6mm well & oiler
  - Ø8mm well & oiler
  - Ø9mm well & oiler
  - Ø10mm well & oiler
  - Ø16mm well & oiler

Code	Description	UOM	Price
047447	Oiler Set, Bergeon 6875	EACH	£515.00



**Online Order Tracking**

**Oiler Set, Bergeon 6885.CB**



Oiler Set - Bergeon Swiss

- 5 oilers, 5 oil cups & 5 pith wood buttons
- Glass oil wells
- Synthetic oil cups
- Plastic oiler handles
- Colour coded oilers, cups & pith woods
- Rotating base
- Supplied in wooden case
- Bergeon 6885.CB

Includes:

- Ø6mm well & oiler
- Ø8mm well & oiler
- Ø10mm well & oiler
- Ø12mm well & oiler
- Ø12mm well & oiler

Code	Description	UOM	Price
047448	Oiler Set, Bergeon 6885.CB	EACH	£159.95

**OPTIVISORS**

- A wide range of professions and hobbies choose to use an optivisor including jewellers, watchmakers/repairers, tool die makers, engravers, craftsmen, artists, architects, needle point cross stitchers, sewers and dentists
- A precision instrument that improves vision and will increase your efficiency
- Optivisor lenses are ground and polished to precision ophthalmic standards
- The Optivisor frame is made of light weight, durable impact resistant materials
- The comfortable continuous headband is fully adjustable to fit any size, quickly and easily
- Adjustable pivot knobs hold visor in any position for easy flip-up viewing
- Can be worn over prescription or safety eyeglasses
- Leaves both hands free

*How to use the Optivisor*

The Optivisor should be worn squarely on the head with the lens plate at the bridge of the nose.

By adjusting the knob at the rear of the unit enough tension can be applied to hold the head band in place.

The adjustable pivots on either side of the visor should be tightened with enough tension to hold the lens in front of the eyes as well as up out of the path of vision when not in use.

## Bergeon Optivisors

Bergeon 5381-DA

- Swiss Made
- Optivisor Binocular magnifier with adjustable visor
- Headband with instant adjustment
- Felt lined leather frontal band fitting the shape of the head
- The visor can be raised or lowered as required
- Bergeon DA model, glass lenses



Magnification:

- Bergeon 5381-DA02 - Mag x1½ @ 51cm (20")
- Bergeon 5381-DA03 - Mag x1¾ @ 36cm (14")
- Bergeon 5381-DA05 - Mag x2½ @ 23cm (8")
- Bergeon 5381-DA07 - Mag x2¾ @ 15cm (6")
- Bergeon 5381-DA10 - Mag x3½ @ 12cm (4")

Code	Description	UOM	Price
O1094	No.2 (Mag x1½) Optivisor	EACH	£79.95
O1095	No.3 (Mag x1¾) Optivisor	EACH	£79.95
O1096	No.5 (Mag x2½) Optivisor	EACH	£79.95
O1097	No.7 (Mag x2¾) Optivisor	EACH	£79.95
O1098	No.10 (Mag x3½) Optivisor	EACH	£79.95
O1093	Opti-Loupe (Mag x2½)	EACH	£14.25
O22257	Lens Plate (Mag x2¾)	EACH	£34.95
O1099	Lens Plate (Mag x3½)	EACH	£33.50

## Donegan Optivisors



Donegan - Made in USA

- Optical glass prismatic lenses: Ground and polished to precision optical standards—bevel edged and mounted in an interchangeable plastic frame
- Scratch resistant lenses
- It tilts: Adjustable pivots allow the visor to be tilted out of the way when not needed and at your fingertips when you need magnification
- Adjustable headband: Conforms to fit all head sizes—fabricated from a special blend lightweight material. Comfortable when worn for long periods of time.
- High impact visor: Provides a tough, durable, always-new appearance
- Genuine leather comfort band: Padded orthopaedic felt adds to comfort
- Donegan DA model, glass lenses

Donegan optical optivisors are innovatively designed to a high quality and manufactured to precision. Several magnifications and focal lengths cover any requirement you may need

Magnification:

- Donegan No.DA-2 - Mag x1½ @ 51cm (20")
- Donegan No.DA-3 - Mag x1¾ @ 36cm (14")
- Donegan No.DA-4 - Mag x2 @ 25cm (10")
- Donegan No.DA-5 - Mag x2½ @ 20cm (8")

- Donegan No.DA-7 - Mag x2¾ @ 15cm (6")
- Donegan No.DA-10 - Mag x3½ @ 12cm (4")

Code	Description	UOM	Price
O1100	No.2 (Mag x1½) Optivisor	EACH	£35.50
O1101	No.3 (Mag x1¾) Optivisor	EACH	£35.50
O1102	No.4 (Mag x2) Optivisor	EACH	£35.50
O1103	No.5 (Mag x2½) Optivisor	EACH	£35.50
O1104	No.7 (Mag x2¾) Optivisor	EACH	£35.50
O1105	No.10 (Mag x3½) Optivisor	EACH	£35.50
O1106	Opti-Loupe (Mag x2½)	EACH	£10.85

## Multi Lens

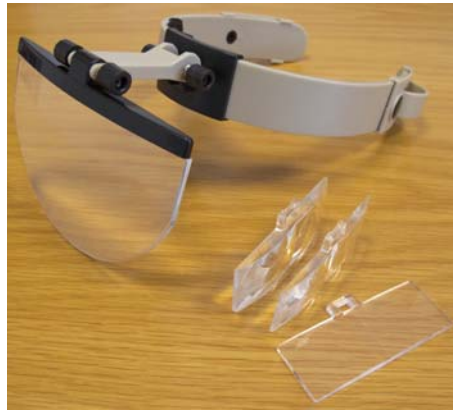

Head loupe magnifier which gives expert quality for hands frees working.

- Used by Jewellers, silversmiths, model makers, arts/crafts, sculptures, antique collectors/restorers, in electronics, for reading, etc
- Wide single lens meaning both eyes can see naturally
- Can be worn with spectacles and has an adjustable headband for greater comfort
- 300mm focal length for comfortable working posture
- With three interchangeable auxiliary lenses

Magnification:

- Main lens x2
- Auxiliary lens 1, x1.5 (used with mains lens becomes x3.5)
- Auxiliary lens 2, x2.5 (used with mains lens becomes x4.5)
- Auxiliary lens 3, x3.5 (used with mains lens becomes x5.5)

Code	Description	UOM	Price
O40252	Multiple Lens Optivisor	EACH	£7.95

## Multi Lens with LED



LED fully adjustable headband magnifier, with multiple lenses and removable LED light source

- Used by Jewellers, silversmiths, model makers, arts/crafts, sculptures, antique collectors/restorers, in electronics, for reading, etc
- Lens size 89 x 29mm, additional single eye lens Ø29mm
- 2 swivel LEDs within a light source that can be angled up and down to provide the direction of light you require
- Light source is detachable, making the item lighter and providing greater comfort
- Can be worn with spectacles and has an adjustable headband for greater comfort

- 2 interchangeable lenses with one additional lens
- x1.5, x3, x8.5 & x10 all possible

Magnification:

- Main lens x1.5
- Auxiliary lens 1, x1.5 (used with mains lens becomes x3)
- Additional single eye lens, x7 (used with mains lens becomes x8.5, used with main lens and auxiliary lens becomes x10)

Code	Description	UOM	Price
O40253	Multiple Lens Optivisor with LED Light	EACH	£5.85

## Multi Lens with LED, Light Tec



LED illuminated head loupe magnifier which gives expert quality for hands frees working.

- Used by Jewellers, silversmiths, model makers arts/crafts, sculptures, antique collectors/restores, electronics, reading, etc
- Removable adjustable illumination angle, up and down 60° and 50° side to side
- Can be worn with spectacles and has an adjustable headband for greater comfort and integral visor to cut out ambient light.
- With four interchangeable lenses supplied with their own storage case and cleaning cloth. The lenses stay firmly in position when raised or lowered, leaving both hands free to work. Lenses are protected with surface strength treatment.
- 3 x AAA (MN2400) Batteries (supplied)

Specification: Magnification x Focal Distance

- x1.2 @ 520 to 620mm
- x1.8 @ 230 to 320mm
- x2.5 @ 150 to 250mm
- x3.5 @ 80 to 120mm

Weight: 560 grams

Code	Description	UOM	Price
O36654	LED Headband Magnifier	EACH	£16.95

## PIN VICES, CHUCKS & TONGS

### PIN CHUCK ADAPTORS

Ideal Adaptor for Micromotors & Pendant Drills

- Multi colleted rotary drill pin vice sets
- Multi shank diameter options
- Useful adapters with different capacity chucks
- Also allows use of miniature drills with normal power drill chucks which do not close to small sizes
- Will fit micro motors and quick release hand pieces

Popular rotary equipment and headpieces for the Multi collets rotary drill pin vice set

- Freedom Handpiece No.18 (Press To Quick Release Action) code FD18
- Freedom High Speed Rotary Micro motor Kit code K1070CE
- Jewellers Kit & No20 "Quick Release" Hand piece code K2220CE



**Pin Chuck Adaptor (shank Ø2.35mm)**



Ideal Adaptor for Micromotors & Pendant Drills

- Multi collets rotary drill pin vice set
- A useful adapter with two different capacity chucks.
- For adapting 2.35mm (3/32") collets on rotary tools and flex shaft hand pieces to more useful range 0 to 2.35mm
- Also allows use of miniature drills with normal power drill chucks which do not close to these sizes
- Will fit micro motors and quick release hand pieces
- Supplied in plastic wallet
- Made in India

Dimensions:

- Shank mount size Ø2.35mm or 3/32"
- Consists of 2 collets:
- Ø1.65 to 2.35mm
- Ø0.00 to 1.15mm

Code	Description	UOM	Price
P39353	Pin Chuck Adaptor (shank Ø2.35mm)	EACH	£2.95

**Pin Chuck Adaptor (shank Ø2.35mm), A\*F Swiss**



A\*F Swiss 182.211

A useful set with different capacity chucks for holding drill bits. Adapts 2.35mm (3/32") collets on rotary tools and hand pieces to a more useful capacity from 0 to 3.00mm.

Ideal adaptor for micromotors & pendant drills especially with quick release hand pieces, plus also allows use of miniature drills with normal power drill chucks which do not close to small sizes.

Dimensions:

- Shank mount size Ø2.35mm or 3/32"
- 4 Collets sizes closing to: Ø0 - 1.5mm - 2mm - 3mm

Code	Description	UOM	Price
P1224	Pin Chuck Adaptor (shank Ø2.35mm)	PACK*4	£8.50
V47213	Ø1.50mm Spare Collet	EACH	£1.15
V47214	Ø2.00mm Spare Collet	EACH	£1.15
V47215	Ø3.00mm Spare Collet	EACH	£1.15

**Pin Chuck Adaptor (shank Ø3.15mm)**



Ideal Adaptor for Micromotors, Pendant Drills or Household drills

- A useful adapter for using micro drills
- For adapting Ø3.15mm (1/8") collets on rotary tools and flex shaft hand pieces to use micro drills
- Also allows use of miniature drills with normal power drill chucks which do not close to these sizes
- Made in India

Dimensions:

- Shank mount size Ø3.15mm or 1/8"
- Ø0.00 to Ø2.00mm capacity

- Overall length 32mm

Code	Description	UOM	Price
P39354	Pin Chuck Adapter (Shank Ø3.15mm)	EACH	£1.50

**Pin Chuck Adaptor (shank Ø6.35mm)**



Pin Chuck Adapter - With Collets

Multi collets rotary drill and hand pin vice set

- A useful adapter with three different capacity chucks.
- Also allows use on bench drills closing down to zero, which other similar models don't close down to.
- Ideal for Bench Drills for holding smaller drills etc creating more accuracy & stability
- Contains a middle body centre hole so you can tighten your items with strength and ease
- Knurled head cap
- Very popular with jewellers, silversmiths, light engineers, model makers and used in arts and crafts

Sizes:

Shank mount size Ø6.35mm

Consists of 3 collets & pin vice:

- 1 - closes to zero
- 2 - closes to Ø1.70mm
- 3 - closes to Ø2.20mm
- Collet length 20mm
- Overall Length 60mm

Recommend bench drill to use with this set: Item Code D9744 - Proxon Bench Drill

Code	Description	UOM	Price
P32162	Pin Chuck Adaptor (shank Ø6.35mm)	PACK*4	£6.95

**PIN TONGS**

*Ideal for holding small tools including drills, broaches and burnishers plus for holding materials for working on including rods and wires.*

**Pin Tongs (Sliding Grip), Bergeon**



Ideal for holding small tools including drills, broaches and burnishers plus for holding materials for working on including rods and wires.

Bergeon 30432

- Holder with slide locking steel jaws
- Nickel plated brass handle
- Steel chuck, opening 0 - 1.5 mm
- Length 110 mm

Code	Description	UOM	Price
P1211	Ø0.00mm to Ø1.50mm, Bergeon Swiss - Slide Locking	EACH	£14.85

**Pin Tongs (Sliding Grip), India**



Ideal for holding small tools including drills, broaches and burnishers plus for holding materials for working on including rods and wires.

Made in India

- Single ended
- Slide locking
- Length 10cm
- Stainless steel
- Round head
- Knurled handle

Code	Description	UOM	Price
V39480	Ø0.00mm to Ø0.75mm, Slide Locking	EACH	£1.95

**PIN VICES, INDIVIDUALS**

*A pin vice is a small type of hand drill/holder used in watch, clock and jewellery making.*

- *The pin vice features an adjustable chuck which holds drill bits, wire or pins*
- *This chuck is the reason for the word "vice" in the name*
- *A pin vice consists of four main sections: a chuck, a screw-on head which covers the chuck bar the tip, a barrel, usually no more than four or five inches long and a rotating knob at the base*
- *The barrel and head are often knurled for better grip. To fit a bit into the pin vice, the user partly unscrews the head, loosening the chuck*
- *The user then inserts a drill bit or whatever he requires into place, tightening the chuck*
- *The chuck will now hold the bit firmly in place*

**Double Ended Pin Vices**

Pin Vices - Double Ended

Save time with a collet ready for use at each end

P5314:

- Ø0 to Ø1.20mm & Ø1.70 to Ø2.50mm

V39478

- Ø0 to Ø1.20mm & Ø1.70 to Ø2.50mm

P1219:

- Ø0 to Ø1.00mm & Ø2.00 to Ø3.00mm (Reversible collets)

P1218:

- Ø0 to Ø1.60mm & Ø1.40 to Ø2.80mm

**Ø0 to Ø1.20mm & Ø1.70 to Ø2.50mm**

**VALUE**



- Length 10cm
- Double Ended: Ø0 to Ø1.20mm & Ø1.70mm to Ø2.50mm
- Hexagonal Heads
- Knurled Handle

• Made in India

Code	Description	UOM	Price
P5314	Ø0 to Ø1.20mm & Ø1.70 to Ø2.50mm	EACH	£2.50

**Ø0 to Ø1.20mm & Ø1.70mm to Ø2.50mm, US Style**

**VALUE**



- Length 10cm
- Double Ended: Ø0 to Ø1.20mm & Ø1.70mm to Ø2.50mm
- Round knurled hexagonal heads
- Knurled Handle
- American pattern
- Made in India

Code	Description	UOM	Price
V39478	Ø0 to Ø1.20mm & Ø1.70mm to Ø2.50mm, US Style	EACH	£2.50

**Ø0 to Ø1.00mm & Ø2.00 to Ø3.00mm, A\*F Swiss**



- A\*F Swiss
- Length 11cm
- Hexagonal Heads
- Knurled Handle

Code	Description	UOM	Price
P1219	Ø0 to Ø1.00mm & Ø2.00 to Ø3.00mm, A*F Swiss	EACH	£9.75

**Ø0 to Ø1.60mm & Ø1.40 to Ø2.80mm, A\*F Swiss - US Style**



- A\*F Swiss
- Length 11cm
- Double Ended: Ø0 to Ø1.60mm & Ø1.40 to Ø2.80mm
- Round Knurled Heads
- Knurled Handle

Code	Description	UOM	Price
P1218	Ø0 to Ø1.60mm & Ø1.40 to Ø2.80mm, A*F Swiss - US Style	EACH	£8.95

**Single Ended Eclipse Style**



"Eclipse" style for holding any length of wire rod.

- A\*F Swiss
- Hollow body
- Blued Steel
- Hardened Steel Jaws

Diameters:

- Ø0 to Ø1.00mm
- Ø0.75 to Ø1.50mm
- Ø1.25 to Ø3.00mm
- Ø2.75 to Ø5.00mm

Code	Description	UOM	Price
V47208	Eclipse Style Set (Ø0 to Ø5.00mm)	PACK*4	£16.95
V47209	Ø0 to Ø1.00mm Eclipse Style	EACH	£4.15
V47210	Ø0.75 to Ø1.50mm Eclipse Style	EACH	£4.50
V47211	Ø1.25 to Ø3.00mm Eclipse Style	EACH	£4.95
V47212	Ø2.75 to Ø5.00mm Eclipse Style	EACH	£5.50

**Single Ended with 1 Collet**

Pin Vices - Single End - 1 Collet

- Single Ended
- 1 Collet
- Mini
- Slim
- Wooden handle
- Heavy duty

**Ø0.00mm to Ø0.75mm (5cm) Mini**



- Single ended - mini
- Length 5cm
- Nickel plated
- Round head

Code	Description	UOM	Price
P1222	Ø0.00mm to Ø0.75mm (5cm) Mini	EACH	£5.95

**Ø0.00mm to Ø0.75mm (10cm) Slim**



- Single ended - slim
- Length 10cm
- Brass
- Round head
- Ø4.50mm body

Code	Description	UOM	Price
V39483	Ø0.00mm to Ø0.75mm (10cm) Slim	EACH	£1.95

**Ø0.00mm to Ø1.00mm (10cm)**



- Single ended
- Knurled wooden handle
- Length 10cm
- French type pin vice

- Wooden handle
- Round head
- Ø4.50mm body

Code	Description	UOM	Price
V39482	Ø0.00mm to Ø1.00mm (10cm)	EACH	£3.95

**Ø0.00mm to Ø7.00mm (15cm)**



- Length: 150mm (6")
- Jaws open to 7mm
- With ergonomic handle and wide jaws
- Heavy Duty
- Weight 300g

Code	Description	UOM	Price
P20874	Ø0.00mm to Ø7.00mm (15cm)	EACH	£6.30

**Single Ended with 1 Collet, A\*F Swiss**



A\*F Swiss - Pin Vices - Single End - 1 Collet

Long narrow pin vices with a hollow brass handle with steel head for holding and working with long pieces of wire or rod which passes through the entire body of the pin vice.

- A\*F Swiss
- Single Ended
- 1 Collet
- Slim
- Various Lengths

Code	Description	UOM	Price
P1212	Ø0.00mm to Ø0.80mm (8cm)	EACH	£5.95
P1213	Ø0.00mm to Ø0.80mm (10cm)	EACH	£6.45
V47200	Ø0.00mm to Ø0.80mm (12cm)	EACH	£6.95

**Single Ended with 2 Collets**

Pin Vices - Single End - 2 Collets

- Single Ended
- 2 Collets
- Brass or stainless steel
- Swivel head or standard
- Knurled handles

**Ø0.00mm to Ø2.50mm (9cm), Swivel Head**



- 2 reversible collets
- Length 9cm
- Swivel head
- Knurled stainless steel handle
- Second collet stored in handle

Code	Description	UOM	Price
V39481	Ø0.00mm to Ø2.50mm (9cm), Swivel Head	EACH	£1.95

**Ø0.00mm to Ø2.70mm (10.5cm), Brass**



- 2 collets
- Square head
- Length 10.5cm
- Knurled brass handle
- Second collet stored in handle

Code	Description	UOM	Price
V39484	Ø0.00mm to Ø2.70mm (10.5cm), Brass	EACH	£2.95

**Single Ended (Square) with 2 Collets, A\*F Swiss**



Pin Vices - Square Head - Single End - 2 Collets - A\*F Swiss

- A\*F Swiss
- Single Ended
- 2 Tempered Steel Collets
- Various Lengths (in brackets)
- Square Head
- Knurled Handle
- Brass

Code	Description	UOM	Price
V47207	Pin Vice Set (7 - 9 - 11 - 13cm)	PACK*4	£29.95
P1214	Ø0.00mm to Ø1.75mm (7cm)	EACH	£6.75
P1215	Ø0.00mm to Ø2.35mm (9cm)	EACH	£7.75
P1216	Ø0.00mm to Ø3.25mm (11cm)	EACH	£8.25
P1217	Ø0.00mm to Ø4.25mm (13cm)	EACH	£10.75

**Single Ended (Round) with 2 Collets, A\*F Swiss**



Pin Vices - Round Head - Single End - 2 Collets - A\*F Swiss

- A\*F Swiss
- Single Ended
- 2 Tempered Steel Collets
- Various Lengths (in brackets)
- Round Head
- Knurled Handle
- Brass

Code	Description	UOM	Price
V47201	Ø0.00mm to Ø1.75mm (7cm)	EACH	£7.95
V47202	Ø0.00mm to Ø2.00mm (8cm)	EACH	£7.95
V47203	Ø0.00mm to Ø2.80mm (9cm)	EACH	£8.50

V47204	Ø0.00mm to Ø3.35mm (10cm)	EACH	£8.75
V47205	Ø0.00mm to Ø3.65mm (11cm)	EACH	£8.95
V47206	Ø0.00mm to Ø3.90mm (12cm)	EACH	£10.30

**PIN VICES, SETS**

*Pin Vices - Sets*

*Pin vice sets prove to be very useful in your busy workshop by having many sizes ready available to hand.*

*Ideal for holding small tools including drills, broaches and burnishers plus for holding materials for working on including rods and wires.*

Swiss and non Swiss sets available

**Square Head (2 Collets), Bergeon**



Bergeon 1842B - Swiss Made

- Square Head with 2 Collets
- Handle in nicked plated brass
- Various Lengths (in brackets)

Set of 4:

- No. 1 = Ø0 to Ø1.00mm & Ø0.80 to Ø2.00mm (8cm)
- No. 2 = Ø0 to Ø1.20mm & Ø1.50 to 3.00mm (10cm)
- No. 3 = Ø0 to Ø1.50mm & Ø2.50 to Ø4.00mm (12cm)
- No. 4 = Ø0 to Ø1.50mm & Ø4.00 to Ø5.00mm (14cm)

Code	Description	UOM	Price
P1210	Square Head (2 Collets) Bergeon 1842B	PACK*4	£55.50

**Square Head (2 Collets)**



Made in Far East

- Square Head with 2 Collets
- Various Lengths (in brackets)
- Brass
- Made in the far east

Set of 4:

- Ø0 to Ø1.60mm & Ø0 to Ø0.60mm (7.5cm)
- Ø0 to Ø1.90mm & Ø1.20 to Ø2.15mm (9cm)
- Ø0 to Ø2.40mm & Ø1.50 to Ø2.75mm (11cm)
- Ø0 to Ø3.30mm & Ø2.00 to Ø3.00mm (14cm)

Code	Description	UOM	Price
P36941	Square Head (2 Collets) Far East	PACK*4	£13.75

**Square Head (2 Collets)**



Made in India

- Square head with 2 collets
- Various Lengths (in brackets)
- Knurled handles
- In smart plastic wallet

Set of 6:

- No. 1 = Ø0 to Ø0.50mm & Ø0.50 to Ø1.60mm (7cm)
- No. 2 = Ø0 to Ø1.00mm & Ø1.00 to Ø2.00mm (8cm)
- No. 3 = Ø0 to Ø1.50mm & Ø1.50 to Ø2.00mm (9cm)
- No. 4 = Ø0 to Ø1.65mm & Ø1.65 to Ø3.00mm (10cm)
- No. 5 = Ø0 to Ø1.75mm & Ø2.10 to Ø3.10mm (11cm)
- No. 6 = Ø0 to Ø1.85mm & Ø2.40 to Ø3.70mm (12cm)

Code	Description	UOM	Price
P37127	Square Head (2 Collets) Indian	PACK*6	£12.50

**Round Head (1 Collet)**



Made in India

- Round head with 1 collets
- Various Lengths (in brackets)
- Chucks of hardened steel
- Black steel finish

Set of 4:

- No. 1 = Ø0 to Ø1.00mm (8cm)
- No. 2 = Ø0 to Ø2.00mm (9cm)
- No. 3 = Ø1.00 to Ø3.00mm (10cm)
- No. 4 = Ø2.50 to Ø4.00mm (10.5cm)

Code	Description	UOM	Price
P35021	Round Head (1 Collets) Indian	PACK*4	£5.95

**Round Head (2 Collets), Bergeon**



Bergeon 30026A - Swiss Made

- Round head with 2 collets
- Various Lengths (in brackets)
- Chucks of hardened steel
- Chromium plated handles
- In smart wooden case

Set of 5:

- No. 1 = Ø0 to Ø0.70mm (8cm)

No. 2 = Ø0.50 to Ø1.00mm & Ø1.00 to Ø1.50mm (9cm)  
 No. 3 = Ø1.00 to Ø1.50mm & Ø1.50 to Ø2.00mm (10cm)  
 No. 4 = Ø2.00 to Ø2.50mm & Ø2.50 to Ø3.00mm (12cm)  
 No. 5 = Ø3.00 to Ø3.50mm & Ø3.50 to Ø4.00mm (13cm)

Code	Description	UOM	Price
P4306	Round Head (2 Collets) Bergeon 30026A	PACK*5	£154.95

## PLIERS

Our pliers are sourced from all over the globe, our huge variety stems from manufacturers in Britain, Switzerland, Germany, America and India ensuring we provide the most suitable pliers for the individual.

Traditionally, European and American brands are considered the highest in quality, but Cousins' value range offers quality engineering at exceptional prices. Now introducing the "Cousins Swiss Style" range of pliers, these tools offer the same superb Swiss quality as other well known brands, at extremely competitive prices.

Cousins' stock of comprehensive pliers can grip, form, bend, twist and hold articles. Pliers are identified by the shape of the jaw and the type of joints at the pivot. Two main types of joint are used in ordinary pliers: the box joint and the lap joint. The box joint type is desirable as the jaws are less inclined to disjoin after heavy use.

Parallel pliers have a more complex pivoting mechanism than standard pliers. The jaws open and close always maintaining a symmetrical motion, giving ultimate control when working, these pliers incredibly reduces slipping.

It is wise to have a selection of pliers on the bench to accommodate every type of job.

## ANTICLASTIC & SYNCLASTIC PLIERS

- Anticlastic is a shape that curves in two opposite directions, giving a saddle shaped effect
- Synclastic is a shape that curves towards the same point in all directions

### Needle File Sets



**Ref: F9455**  
See Page: 865

### Anticlastic Channel Plier



Anticlastic is a shape that curves in two opposite directions, giving a saddle shaped effect. This unique anticlastic plier allows you to easily create anticlastic shapes from sheet metal. Produces a fine, finished product in a fraction of the time without having to use a dapping tool

- Anticlastic plier
- Creates a saddle shape in sheet metal
- Excellent for rings, bangles & bracelets
- PVC covered handles
- Channel width: 6, 10 or 15mm
- Overall length: 200mm
- Cousins Swiss Style
- Superb Swiss style quality

Code	Description	UOM	Price
P49167	6mm Channel Anticlastic Pliers	EACH	£22.95
P48852	10mm Channel Anticlastic Pliers	EACH	£22.95
P48602	15mm Channel Anticlastic Pliers	EACH	£25.95

### Anticlastic Cylinder Plier



Anticlastic is a shape that curves in two opposite directions, giving a saddle shaped effect. This unique anticlastic cylinder plier allows you to easily create anticlastic shapes from sheet metal. The ring gives extra support, provides even, uniform curving as well as the ability to make tight curvatures more easily. Produces a fine, finished product in a fraction of the time without having to use a dapping tool

- Anticlastic cylinder plier
- Creates a saddle shape in sheet metal
- Excellent for rings, bangles & bracelets
- Gives a tight, uniform curve
- Blue PVC covered handles
- Overall length: 200mm
- Cousins Swiss Style
- Superb Swiss style quality

Dimensions:

- Channel width (cylinder diameter)

Code	Description	UOM	Price
P48613	6mm (Ø28mm) Anticlastic Cylinder Plier	EACH	£25.95
P48609	12mm (Ø50mm) Anticlastic Cylinder Plier	EACH	£25.95

## PRICE PROMISE GUARANTEE

### Synclastic Pliers



Synclastic is a shape that curves towards the same point in all directions. These synclastic pliers put two curvatures into flat stock simultaneously without marring. Create a bracelet in minutes, not hours. Also makes rings, bangles and is indispensable in doing jewellery repair work.

- Synclastic plier
- Creates two curves in sheet metal
- Excellent for rings, bangles & bracelets
- Channel width: 9, 12 or 17mm
- Overall length: 210mm
- PVC coated handles
- Cousins Swiss Style
- Superb Swiss style quality

Code	Description	UOM	Price
P48853	9mm Channel Synclastic Pliers	EACH	£22.95
P48601	12mm Channel Synclastic Pliers	EACH	£25.95
P48610	17mm Channel Synclastic Pliers	EACH	£25.95

## BEADING PLIERS

### Bead Crimping Pliers

Fast and efficient closure technique to replace or hide thread knots and securely join clasps etc onto beaded jewellery. Specially profiled and preset jaws first indent and then roll the crimp to 2mm diameter in a simple two stage process.

- Accepts crimp tubes up to 3mm
- Simple two stage process
- Instructions included
- Crimps: see our product codes B0045 (white) and B0046 (yellow)
- A\*F Swiss or unbranded

### A\*F Swiss Bead Crimping Pliers



- A\*F Swiss 180.540
- Accepts crimp tubes up to 3mm

- Simple two stage process
- Instructions included
- Crimps: see our product codes B0045 (white) and B0046 (yellow)

Code	Description	UOM	Price
P1239	A*F Swiss Bead Crimping Pliers	EACH	£17.50

**Value Bead Crimping Pliers**

**VALUE**



- Accepts crimp tubes up to 3mm
- Simple two stage process
- Instructions included
- Crimps: see our product codes B0045 (white) and B0046 (yellow)
- Made in India

Code	Description	UOM	Price
B35078	Value Bead Crimping Pliers	EACH	£3.95

**Value Bow Ring Opening Pliers**

**VALUE**



- Reverse action notched tips
- Spring loaded arms
- Length 140mm
- Tapered nose tips
- Made in India

Code	Description	UOM	Price
P39046	Value Bow Ring Opening Pliers	EACH	£5.95

**CHANNEL PLIERS**

**Channel Pliers**

**COUSINSUK**



These pliers have a round cylinder and a half round channel and are perfect for putting large radius curves into flat sheet metal. The piece can then easily be defined using a mandrel.

- Channel pliers
- Single cylinder with half round channel
- Easily and accurately put large curves into metal
- Excellent for making bracelets, bezels and large rings
- Blue plastic coated handles
- Stainless steel
- Channel diameters: Ø20 or Ø35mm
- Overall length 165mm
- Cousins Swiss Style
- Superb Swiss style quality

Code	Description	UOM	Price
P48612	Ø20mm Channel Pliers	EACH	£12.95
P48854	Ø35mm Channel Pliers	EACH	£14.95

**CIR-CLIP SNAP RING PLIERS**

**Cir-clip Snap Ring Pliers Set**



Cousins "4 in 1" Snap Ring Pliers Set, designed for value

- An essential tool for maintaining a rolling mill such as removing, replacing and realigning rolls on a rolling mill including extensions (R19136).
- For internal and external snap rings from 3/8 to 2"
- The set includes three convertible tips 180°, 90° and 45°.
- Jaws can easily be interchanged for different applications.

Code	Description	UOM	Price
P33147	Cir-clip Snap Ring Plier Set	EACH	£3.25

**CURVED JAW PLIERS**

**Curved Jaw Pliers**

Ideal for bending rings or producing curves. With polished steel jaws, one half round and one concave. Box joint and plastic covered handles

A\*F, Bergeon or Value

- Excellent for ring/bracelet shaping
- Profiled concave/convex jaws
- Sleeved arms
- Box joint

**A\*F Swiss (160mm) Heavy Duty**

**A\*F SWITZERLAND**



A\*F Exclusive - Large metal forming top quality pliers for work on heavier jewellery. Ideal for bending rings or producing curves. With polished steel jaws, one half round and one concave. Box joint and plastic covered handles

- A\*F Swiss 125.197
- Ring shaping etc
- Profiled concave/convex jaws
- Sleeved arms
- Box joint
- Length 160mm

**BOW RING OPENING PLIERS**

**A\*F Swiss Bow Ring Opening Pliers**

**A\*F SWITZERLAND**



- A\*F Swiss 180.944
- Reverse action notched tips
- Spring loaded arms
- Length 140mm
- Tapered nose tips

Code	Description	UOM	Price
P2962	A*F Swiss Bow Ring Opening Pliers	EACH	£26.85

**+ Contact & Services**

**Your direct line to our Management Team**  
*Instant Message Service*

• 9mm wide tips

Code	Description	UOM	Price
P2961	A*F Swiss (160mm) Heavy Duty	EACH	£38.50

**A\*F Swiss (165mm) Heavy Duty Adjustable**



A\*F Exclusive - Large metal forming top quality pliers for work on heavier jewellery. Ideal for bending rings or producing curves. With polished steel jaws, box joint and plastic covered handles.

- A\*F Swiss 125.198
- Ring shaping etc
- Heavy concave jaws with convex former
- Sliding concave jaw gives varying radius faces
- Length 165mm box joint
- 19 and 8mm tips

Code	Description	UOM	Price
P1246	A*F Swiss (165mm) Heavy Duty Adjustable	EACH	£52.35

**Bergeon (130mm)**



- Bergeon 6126
- Ring shaping etc
- Profiled concave/convex jaws
- Sleeved arms
- Box joint
- Length 130mm
- 7mm wide tips

Code	Description	UOM	Price
P4386	Bergeon (130mm)	EACH	£39.95

**Tool Rack Wall Mounted**



Ref: S36086  
See Page: 781

**Value (130mm)**

**VALUE**



- Ring shaping etc
- Profiled concave/convex jaws
- Sleeved arms
- Box joint
- Length 130mm
- 6.5mm wide tips

Code	Description	UOM	Price
P4787	Value (130mm)	EACH	£3.95

**CURVED JAW PLIERS (NYLON JAWS)**

**Curved Jaw Pliers (Nylon Jaws)**

With a gentle ark for bracelets, the nylon jaw of these pliers cannot scratch. Makes reshaping bracelets easy. Order extra sets of nylon jaws and customize your own shape jaws for any task by simply carving the nylon with a knife.

A\*F Swiss or Cousins Swiss Style

- Polished Stainless Steel
- With (Cousins Swiss Style) or without (A\*F) double leaf springs
- PVC coated or metal handles
- Replacement Jaws Available
- Length 145mm

**A\*F Swiss (145mm) Nylon Jaws**



- A\*F Swiss
- Polished Stainless Steel
- Metal Handles
- Supplied with an extra set of jaws
- Replacement Jaws Available
- Length 145mm

Code	Description	UOM	Price
P47121	A*F Swiss (145mm) Nylon Jaws	EACH	£22.50

**IMPROVED SPEED SEARCH**

**Replacement Jaws, A\*F Swiss**

A\*F Swiss - Customize your own shape jaws for any task by simply carving the nylon with a knife.

- Replacement Nylon Jaws
- for tool P47121



Code	Description	UOM	Price
P47122	Replacement Jaws, A*F Swiss	PAIR	£8.15

**Cousins Swiss Style (145mm) Nylon Jaws**



- Cousins Swiss Style
- Superb Swiss quality pliers
- Polished Stainless Steel
- Blue plastic handles
- Spring loaded (double leaf springs)
- Supplied with extra set of jaws
- Length 145mm

Code	Description	UOM	Price
P48579	Cousins Swiss Style (145mm) Nylon Jaws	EACH	£14.95

**Replacement Jaws, Cousins Swiss Style**

Cousins Swiss Style - Customize your own shape jaws for any task by simply carving the nylon with a knife.

- Replacement Nylon Jaws
- for tool P48579



Code	Description	UOM	Price
P48580	Replacement Jaws, Cousins Swiss Style	PAIR	£2.95

**Tool Rack Organiser**

**BEST SELLER**



Ref: T45704 See Page: 780

## CYLINDER PLIERS

### Cylinder Pliers



These pliers have two different size cylinders which can be used to quickly and accurately put large radius curves into flat sheet metal. The piece can then easily be defined using a mandrel.

- Double cylinder
- Easily and accurately put large curves into metal
- Excellent for making bracelets, bezels and large rings
- Blue PVC coated handles
- Stainless steel
- Overall length 165mm
- Sizes given are the cylinder diameters
- Cousins Swis style
- Superb Swiss style quality

Code	Description	UOM	Price
P48599	Ø16 & 19mm Cylinder Pliers	EACH	£13.95
P48598	Ø16 & 26mm Cylinder Pliers	EACH	£13.95
P48600	Ø19 & 26mm Cylinder Pliers	EACH	£13.95
P48597	Ø26 & 35mm Cylinder Pliers	EACH	£13.95
P48596	Ø35 & 42mm Cylinder Pliers	EACH	£13.95

- Superb Swiss quality
- Cousins Swiss Style

Code	Description	UOM	Price
P48636	Duck Billed Pliers	EACH	£9.95

## FLAT NOSE PLIERS

### Flat Nose Pliers

With flat nose pliers, both jaws are perfectly flat with a rectangular cross-section. Flat nose pliers are useful for a variety of tasks, including but not limited to:

- Twisting angles in wire and sheet
- Holding small beads
- Securing bezel wire during filing
- Opening and closing jump rings
- A\*F, Bergeon, Cousins Swiss Style or Value

Types available:

- Serrated Jaws
- Smooth Jaws
- Spring loaded
- Manual action
- Extra Long
- Smart grip
- Cushion grip
- Heavy duty
- Multi size

### A\*F Swiss (115mm) Smooth



- A\*F Swiss 180.73
- Superior quality pliers
- Polished steel
- Box joint
- Blue plastic handles with double leaf springs
- Flat Nose
- Length 115mm

Code	Description	UOM	Price
P47350	A*F Swiss (115mm) Smooth	EACH	£17.95

### A\*F Swiss (115mm) Smooth, Smart Grip



- A\*F Swiss 180.773
- Superb quality pliers

- With comfortable "Smart Grip" blue and black handles
- Flat Nose
- Length 115mm

Code	Description	UOM	Price
P47341	A*F Swiss (115mm) Smooth, Smart Grip	EACH	£16.95

### A\*F Swiss (130mm) Serrated



- A\*F Swiss 180.585
- Superior quality pliers
- Polished steel
- Box joint
- Plastic covered handles
- Flat Nose
- Serrated
- Length 130mm

Code	Description	UOM	Price
P47358	A*F Swiss (130mm) Serrated	EACH	£19.95

### A\*F Swiss (130mm) Smooth



- A\*F Swiss 180.58
- Superior quality pliers
- Polished steel
- Box joint
- Plastic covered handles
- Flat Nose
- Smooth
- Length 130mm

Code	Description	UOM	Price
P47357	A*F Swiss (130mm) Smooth	EACH	£18.95

### A\*F Swiss (130mm) Smooth, Smart Grip

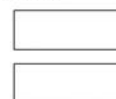

- A\*F Swiss 180.758
- Superb quality pliers
- With comfortable "Smart Grip" blue and black handles
- Flat Nose

## DUCK BILLED PLIERS

### Duck Billed Pliers



These pliers offer a fantastic alternative to standard flat nose pliers. Splaying out from the base, the flat jaws offer a wide or narrow platform for holding or forming metal or jewellery work.

- 25mm long jaws
- 15mm wide at the tip
- Overall length 175mm
- PVC coated handles
- Polished steel
- Box Joint

• Length 30mm

Code	Description	UOM	Price
P47340	A*F Swiss (130mm) Smooth, Smart Grip	EACH	£16.95

**A\*F Swiss (160mm) Smooth, Heavy Duty**



- A\*F Swiss 125.196
- A\*F exclusive
- Polished Steel Flat Jaws
- Smooth Jaws
- Length 160mm

Code	Description	UOM	Price
P47115	A*F Swiss (160mm) Smooth, Heavy Duty	EACH	£26.50

- Sleeved polished steel arms
- Length 130mm
- 5mm wide tips

Code	Description	UOM	Price
P1236	Bergeon (130mm) Serrated	EACH	£27.95

**Bergeon (130mm) Smooth**



- Bergeon 2624D
- Smooth box joint jaws
- Sleeved polished steel arms
- Length 130mm
- 5mm wide tips (approx.)

Code	Description	UOM	Price
P47379	Bergeon (130mm) Smooth	EACH	£24.95

**Cousins Swiss Style (130mm) Smooth, Smart Grip**



- Cousins Swiss Style
- Superb Swiss quality pliers
- With comfortable "Smart Grip" blue and black handles
- Flat Nose
- Length 130mm
- Spring loaded (double leaf springs)

Code	Description	UOM	Price
P48558	Cousins Swiss Style (130mm) Smooth, Smart Grip	EACH	£8.95

**Bergeon (115mm) Smooth**

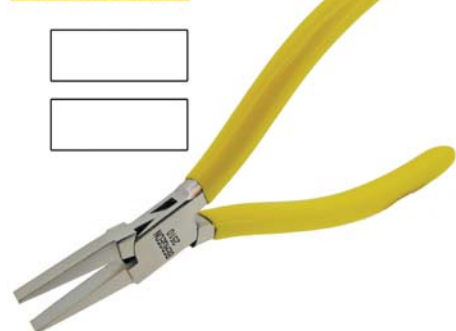

- Bergeon 2510
- Smooth box joint jaws
- Sleeved nickel plated arms
- Length 115mm
- 4mm wide tips

Code	Description	UOM	Price
P1235	Bergeon (115mm) Smooth	EACH	£23.50

**Bergeon (140mm) Serrated, Long Nose**



- Bergeon 6295
- Serrated box joint jaws
- Sleeved arms
- 45mm joint to tips
- Length 140mm
- Long Nose
- 5mm wide tips

Code	Description	UOM	Price
P8813	Bergeon (140mm) Serrated, Long Nose	EACH	£26.95

**Cousins Swiss Style (150mm) Smooth**



- Cousins Swiss Style
- Superb Swiss quality pliers
- PVC coated handles
- Flat Nose
- Length 150mm
- Spring loaded (double leaf springs)

Code	Description	UOM	Price
P48565	Cousins Swiss Style (150mm) Smooth	EACH	£8.95

**Bergeon (130mm) Serrated**

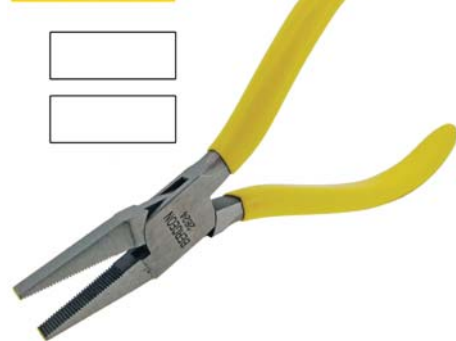

- Bergeon 2624
- Serrated box joint jaws

PRICE PROMISE GUARANTEE

SAME DAY DISPATCH

[www.cousinsuk.com](http://www.cousinsuk.com) Online Discounts

Hand Held Vice  
See Page 1048

Hand Drill with Chuck  
See Page 661



Value (115mm) Smooth

VALUE



- Spring loaded sleeved arms
- Length 115mm
- 5mm wide tips
- Smooth Jaws

Code	Description	UOM	Price
P4777	Value (115mm) Smooth	EACH	£4.50

Value (140mm) Serrated, Long Nose

VALUE



Long nose, long reach pliers; very useful, access awkward and hard to get too fiddly places with smooth box joint jaws and coated sleeved arms. Also used to form wider bends, to straighten, flatten and angle metal.

Its serrated grip dramatically reduces slipping, making it ideal for holding components.

- Length 140mm
- Box Joint
- Sleeved Arms
- Fine Tips
- Serrated Jaws

Code	Description	UOM	Price
P32762	Value (140mm) Serrated, Long Nose	EACH	£3.95

Value (155mm) Smooth, Cushion Grip

VALUE



- Bearing ring lap joint design which one can tighten if the plier's action loosens. This ensures superior performance to other pliers.
- Cushion grips with stainless steel leaf springs.
- The set screw, just behind where the two handles are connected, controls how far the pliers can close. Setting them so that the pliers can only close to your preferred thickness can prevent "over breaking".
- Length 155mm

Code	Description	UOM	Price
P35670	Value (155mm) Smooth, Cushion Grip	EACH	£5.95

Value (130mm) Serrated

VALUE



- Serrated box joint jaws
- Sleeved arms
- Length 130mm
- 6mm wide tips

Code	Description	UOM	Price
P4778	Value (130mm) Serrated	EACH	£4.50

Value (140mm) Smooth, Long Nose

VALUE



Long nose, long reach pliers; very useful, access awkward and hard to get too fiddly places with smooth box joint jaws and coated sleeved arms. Also used to form wider bends, to straighten, flatten and angle metal.

- Length 140mm
- Box Joint
- Sleeved Arms
- Fine Tips
- Smooth Jaws

Code	Description	UOM	Price
P32761	Value (140mm) Smooth, Long Nose	EACH	£3.95

FLAT NOSE PLIERS (BRASS JAWS)

Flat Nose Pliers (Brass Jaws)

Flat nosed pliers with brass inserts to avoid any damage to the object being held. Great for holding & bending metals without scratching including watch bracelets.

- A\*F Swiss or unbranded
- Sleeved arms
- Polished Steel
- Overall length 130mm

Value (130mm) Smooth

VALUE



- Sleeved arms
- Length 130mm
- 7mm wide tips
- Smooth Jaws

Code	Description	UOM	Price
P4776	Value (130mm) Smooth	EACH	£3.95

A\*F Swiss (130mm) Brass Lined



- A\*F Swiss 180.945
- Sleeved Arms
- Polished Steel
- Brass Lined Jaws
- Overall Length 130mm

Code	Description	UOM	Price
P47113	A*F Swiss (130mm) Brass Lined	EACH	£49.95

Stone Setting Including Burnishers



See Page 1029

Riffler Swiss Vallorbe Files



See Page 868

WORLDWIDE DELIVERY

PRICE PROMISE GUARANTEE

Value (130mm) Brass Lined

**VALUE**



- Sleeved Arms
- Brass Lined Jaws
- Overall Length 130mm

Code	Description	UOM	Price
P39492	Value (130mm) Brass Lined	EACH	£4.75

**FLAT NOSE PLIERS (NYLON JAWS)**

**Flat Nose Pliers (Nylon Jaws)**

Used for gripping and bending metal without damaging the surface. Also used by opticians for adjusting spectacle frames. Box joint in polished stainless steel with replaceable nylon jaws.

A\*F, Bergeon, Cousins Swiss Style or Value

- Nylon Jaw Pliers
- Flat faced jaws to protect delicate, soft or polished jobs
- Length 140mm
- Jaw widths 7mm & 12mm
- Replacement jaws available

**A\*F Swiss (140mm) 7mm Nylon Jaws**



- A\*F Swiss
- Nylon Jaw Pliers
- Length 140mm
- Jaw widths 7mm

Code	Description	UOM	Price
P47119	A*F Swiss (140mm) 7mm Nylon Jaws	EACH	£9.50

**Replacement (A\*F Swiss) 7mm Nylon Jaws**

- A\*F Swiss
- Replacement Nylon Jaws
- Length 25mm
- Widths 7mm



Code	Description	UOM	Price
P47120	Replacement (A*F Swiss) 7mm Nylon Jaws	PAIR	£2.95

**A\*F Swiss (140mm) 12mm Nylon Jaws**



- A\*F Swiss
- Nylon Jaw Pliers
- Length 140mm
- Jaw widths 12mm

Code	Description	UOM	Price
P47117	A*F Swiss (140mm) 12mm Nylon Jaws	EACH	£9.50

**Replacement (A\*F Swiss) 12mm Nylon Jaws**

- A\*F Swiss
- Replacement Nylon Jaws
- Length 25mm
- Widths 12mm



Code	Description	UOM	Price
P47118	Replacement (A*F Swiss) 12mm Nylon Jaws	PAIR	£2.95

**Bergeon (130mm) 10mm Nylon Jaws**



- Bergeon 6143 - Swiss Made
- Nylon Jaws
- Flat faced replaceable jaws to protect delicate, soft or polished jobs

- Length 130mm
- Jaw width 10mm

Code	Description	UOM	Price
P8782	Bergeon (130mm) 10mm Nylon Jaws	EACH	£36.95

**Replacement (Bergeon) 10mm Nylon Jaws**

- Bergeon 6143D - Swiss Made
- Nylon Jaws
- 10mm Width
- To suit Bergeon 6143 plier (P8782)



Code	Description	UOM	Price
P8782A	Replacement (Bergeon) 10mm Nylon Jaws	EACH	£10.95

**Cousins Swiss Style (140mm) 12mm Nylon Jaws**



- Cousins Swiss Style
- Flat nylon jaws
- PVC coated arms
- Jaw width 12mm
- Overall length 140mm
- Highly polished stainless steel
- Spring loaded (double leaf springs)
- Supplied with extra set of jaws
- Cousins Swiss Style
- Superb Swiss quality pliers

Code	Description	UOM	Price
P48616	Cousins Swiss Style (140mm) 12mm Nylon Jaws	EACH	£8.95

**Replacement (Cousins Swiss Style) 12mm Nylon Jaws**

- Cousins Swiss Style
- Replacement Nylon Jaws
- For tool P48616



Code	Description	UOM	Price
P48617	Replacement (Cousins Swiss Style) 12mm Nylon Jaws	PAIR	£1.95

**Plier & Cutter Rack**



Ref: P37129  
See Page: 780

**SAME DAY DISPATCH**

Value (130mm) 8mm Plastic Jaws

VALUE



Used for gripping and bending metal without damaging the surface. Also used by opticians for adjusting spectacle frames. Box joint.

- Plastic Jaw Pliers
- Flat faced jaws to protect delicate, soft or polished jobs
- Length 130mm
- Jaw width 8mm

Code	Description	UOM	Price
P35022	Value (130mm) 8mm Plastic Jaws	EACH	£3.95

Value (130mm) 8mm Plastic Jaws, Leaf Springs

VALUE



Used for gripping and bending metal without damaging the surface. Also used by opticians for adjusting spectacle frames. Box joint.

- Plastic Jaw Pliers
- Flat faced jaws to protect delicate, soft or polished jobs
- Leaf Springs
- Length 130mm
- Jaw width 8mm

Code	Description	UOM	Price
P45597	Value (130mm) 8mm Plastic Jaws, Leaf Springs	EACH	£4.10

HALF ROUND & FLAT NOSE PLIERS

Half Round & Flat Nose Pliers

Pliers for bending and shaping flat metal and wire. One jaw flat, the other half round. Box joint in polished steel.

- Jewellery making etc
- Combined flat and half round profiles
- Sleeved arms
- Box joint
- A\*F, Bergeon or Value

A\*F Swiss (160mm), Heavy Duty

A\*F SWITZERLAND



A\*F Swiss - Exclusive

Large metal forming top quality pliers for work on heavier jewellery. Ideal for bending rings or producing curves. With polished steel jaws, one flat and one half round. Box joint and plastic covered handles.

- A\*F Swiss 125.195
- Jewellery making etc
- Combined flat and half round profiles
- Sleeved arms
- Box joint
- Length 160mm
- 8mm wide tips

Code	Description	UOM	Price
P4185	A*F Swiss (160mm), Heavy Duty	EACH	£31.55

Bergeon (130mm)

BERGEON



- Bergeon 5830
- Jewellery making etc
- Combined flat and half round profiles
- Sleeved arms
- Box joint
- Length 130mm
- 5mm wide tip

Code	Description	UOM	Price
P4264	Bergeon (130mm)	EACH	£33.25

Value (130mm)

VALUE



- Jewellery making etc
- Combined flat and half round profiles
- Sleeved arms

- Box joint
- Length 130mm
- 6mm wide tip

Code	Description	UOM	Price
P4784	Value (130mm)	EACH	£3.75

HALF ROUND & FLAT NOSE PLIERS (NYLON JAWS)

Half Round & Flat Nose Pliers (One Nylon Jaw)

COUSINS UK



Pliers for bending and shaping flat metal and wire. With one polished half round steel jaw and one flat nylon (plastic) jaw. Box joint and plastic covered handles.

- Nylon flat nose jaw & steel half round jaw
- Combined flat and half round profiles
- PVC coated arms
- Box joint
- Spring loaded (double leaf springs)
- Nylon jaw ensure delicate items/soft precious metals are not marked
- Supplied with extra nylon jaw
- Cousins Swiss style
- Superb Swiss quality pliers

Code	Description	UOM	Price
P48618	Cousins Swiss Style (140mm) Nylon Jaw	EACH	£9.95
P48619	Replacement Jaw, Cousins Swiss Style	EACH	£1.95

Half Round & Flat Nose Pliers (Nylon Jaws)

COUSINS UK



Pliers for bending and shaping flat metal and wire. With both jaws made of nylon for extra protection. Box joint and plastic covered handles.

- Nylon flat & nylon half round jaw
- Combined flat and half round profiles
- PVC coated handles

- Box joint
- Spring loaded (double leaf springs)
- Supplied with extra set of nylon jaws
- Nylon jaws ensure delicate items/soft precious metals are not marked
- Cousins Swiss style
- Superb Swiss quality pliers

Code	Description	UOM	Price
P48620	Half Round & Flat Nose Pliers (Nylon Jaws)	EACH	£10.95
P48621	Replacement Jaws, Cousins Swiss Style	PAIR	£1.95

## HOLE PUNCHING (METAL) PLIERS

### Hole Punching (Metal) Pliers



These metal hole punching pliers will save you precious time & money. Perfect for making holes in pendants, jewellery & sheet metal.

- Will punch silver or copper up to 18 gauge (1.25mm) thick
- 2 sizes available
- Comfortable "Smart Grip" handles
- Carbon steel jaws with a tempered steel punch pin
- Spare pins available
- Overall length 130mm
- Spring loaded
- Superb Swiss quality
- Cousins Swiss Style

Code	Description	UOM	Price
P48632	Ø1.25mm Punch Plier	EACH	£8.95
P48633	Ø1.25mm Replacement Pin	EACH	£0.95
P48634	Ø1.80mm Punch Plier	EACH	£8.95
P48635	Ø1.80mm Replacement Pin	EACH	£0.95

## Tool Box Tidy



**Ref: B9477**  
**See Page: 780**

### Hole Punching (Metal) Pliers, Parallel Action



These metal hole punching pliers will save you precious time & money. Perfect for making holes in pendants, jewellery & sheet metal.

- Will punch silver or copper up to 18 gauge (1.25mm) thick
- Ø1.50mm punch
- Parallel action
- Carbon steel jaws with a tempered steel punch pin
- Spring loaded
- Overall length 125mm
- Spare pins available
- Superb Swiss quality
- Cousins Swiss Style

Code	Description	UOM	Price
P48642	Ø1.50mm Punch Plier	EACH	£13.95
P48643	Ø1.50mm Punch	EACH	£1.25

## LOOP CLOSING PLIERS

### Loop Closing Pliers

Loop closing pliers, effortless closing of small loops, bows, jump rings and oval forms.

- Great for closing jump rings & split rings
- Spring loaded
- Sleeved arms
- Indentations in the jaws for easy holding of jump or split rings
- Length 135mm

### Value (135mm)



- Great for closing jump rings & split rings
- Spring loaded
- Sleeved arms

- Indentations in the jaws for easy holding of jump or split rings
- Length 135mm

Code	Description	UOM	Price
P39490	Value (135mm)	EACH	£4.50

### Value (135mm) Chunky Handle



- Great for closing jump rings & split rings
- Spring loaded
- Sleeved arms
- Chunky handle, extra grip
- Indentations in the jaws for easy holding of jump or split rings
- Length 135mm

Code	Description	UOM	Price
P42391	Value (135mm) Chunky Handle	EACH	£5.95

## PARALLEL ACTION PLIERS

- Parallel Action
  - Parallel Action with Cutter
  - Parallel Action with Snipe Nose
- Maun Pliers established since 1944. Made in United Kingdom*

*Maun Pliers have a compound lever action giving considerable mechanical advantage for gripping operations. All contain an anti-rust finish with bright nickel plated handles and fully treated, chemically, anti-glare blacked jaws.*

*All of these pliers open and close whilst the jaws maintain constantly parallel, giving a square vice-like grip. This is particularly useful when clamping something in the pliers, the pressure is exerted in the jaws hence minimal pressure in the handle and on the hands should be applied with exactly opposite force without slippage.*

*Pliers with cutting jaws are constructed of high quality materials which are to provide exceptional durability and give you extra comfort plus power because of the unique compound lever action pliers construction.*

### Flat Nose

The parallel action makes these pliers ideal for holding and gripping wire which can be fed down the throat of the plier and held firmly over the full length of the jaw.

- Parallel Action Pliers
- Length: 125, 140 & 160mm
- Maximum Jaw Opening: 10mm & 14mm
- Serrated & Smooth Jaws
- Manual action or spring loaded
- Maun or Cousins Swiss Style

**125mm (Serrated) Cousins Swiss Style**



- Cousins Swiss Style
- Parallel Action Pliers
  - Flat nose
  - Length: 125mm
  - Maximum Jaw Opening: 14mm
  - Serrated Jaws
  - One face with centre groove

Code	Description	UOM	Price
P48582	125mm (Serrated) Cousins Swiss Style	EACH	£9.95

**140mm (Serrated) Cousins Swiss Style**



- Cousins Swiss Style
- Parallel Action Pliers
  - Flat nose
  - Length: 140mm
  - Maximum Jaw Opening: 10mm
  - Serrated Jaws
  - One face with centre groove

Code	Description	UOM	Price
P48584	140mm (Serrated) Cousins Swiss Style	EACH	£9.95

**140mm (Serrated) Maun 4860.140**



- Maun 4860.140
- Parallel Action Pliers
  - Flat nose
  - Length: 140mm
  - Maximum Jaw Opening: 10mm
  - Serrated Jaws
  - One face with centre groove

Code	Description	UOM	Price
P33214	140mm (Serrated) Maun 4860.140	EACH	£19.95

**125mm (Smooth) Cousins Swiss Style**



- Cousins Swiss Style
- Parallel Action Pliers
  - Flat nose
  - Length: 125mm
  - Maximum Jaw Opening: 10mm
  - Smooth Jaws

Code	Description	UOM	Price
P48581	125mm (Smooth) Cousins Swiss Style	EACH	£9.95

**140mm (Serrated) Cousins Swiss Style, Spring Loaded**



- Cousins Swiss Style
- Parallel Action Pliers
  - Flat nose
  - Length: 140mm
  - Maximum Jaw Opening: 10mm
  - Serrated Jaws
  - One face with centre groove
  - Spring loaded

Code	Description	UOM	Price
P48587	140mm (Serrated) Cousins Swiss Style, Spring Loaded	EACH	£10.95

**140mm (Smooth) Cousins Swiss Style**



- Cousins Swiss Style
- Parallel Action Pliers
  - Flat nose
  - Length: 140mm
  - Maximum Jaw Opening: 14mm
  - Smooth Jaws

Code	Description	UOM	Price
P48583	140mm (Smooth) Cousins Swiss Style	EACH	£9.95

**PRICE PROMISE GUARANTEE**

**BROWSE & BUY**

**Protecting Finger Cots**

Ref: P12161  
See Page: 720



**Maun Cutters**

See Page 827



**Workshop Heavy Duty Vice**

See Page 1047



**HSS Drills**

See Page 836



**140mm (Smooth) Cousins Swiss Style, Spring Loaded**  
**COUSINSUK**



- Cousins Swiss Style
- Parallel Action Pliers
  - Flat nose
  - Length: 140mm
  - Maximum Jaw Opening: 10mm
  - Smooth Jaws
  - Spring loaded

Code	Description	UOM	Price
P48586	140mm (Smooth) Cousins Swiss Style, Spring Loaded	EACH	£10.95

**140mm (Smooth) Maun 4870.140**



- Maun 4870.140
- Parallel Action Pliers
  - Flat nose
  - Length: 140mm
  - Maximum Jaw Opening: 10mm
  - Smooth Jaws

Code	Description	UOM	Price
P4753	140mm (Smooth) Maun 4870.140	EACH	£17.55

**160mm (Serrated) Maun 4860.160**



- Maun 4860.160
- Parallel Action Pliers
  - Flat nose
  - Length: 160mm
  - Maximum Jaw Opening: 14mm
  - Serrated Jaws

Code	Description	UOM	Price
P33210	160mm (Serrated) Maun 4860.160	EACH	£25.50

**160mm (Serrated) Maun 4861.160, Sprung Loaded**



- Maun 4861.160 - Sprung Loaded
- Parallel Action Pliers
  - Flat nose
  - Length: 160mm
  - Maximum Jaw Opening: 14mm
  - Serrated Jaws
  - Sprung loaded
  - One face with centre groove

Code	Description	UOM	Price
P33213	160mm (Serrated) Maun 4861.160, Sprung Loaded	EACH	£20.50

**Flat Nose with Brass Jaws**

The parallel action makes these pliers ideal for holding and gripping wire which can be fed down the throat of the plier and held firmly over the full length of the jaw. The brass jaws are excellent for use with delicate items and precious metals

- Parallel Action Pliers
- Length: 140mm
- Maximum Jaw Opening: 10mm
- Smooth brass jaws
- Manual action or spring loaded
- Cousins Swiss Style

**140mm (Smooth) Cousins Swiss Style**



- Cousins Swiss Style
- Parallel Action Pliers
  - Flat nose
  - Brass jaws
  - Length: 140mm
  - Maximum Jaw Opening: 10mm
  - Smooth Jaws

Code	Description	UOM	Price
P48585	140mm (Smooth) Cousins Swiss Style	EACH	£14.95

**140mm (Smooth) Cousins Swiss Style, Spring Loaded**



- Cousins Swiss Style
- Parallel Action Pliers
  - Flat nose
  - Brass jaws
  - Length: 140mm
  - Maximum Jaw Opening: 10mm



**ONLINE ORDER STATUS**

Hand Drill with Chuck

See Page 661



**Guillotine Cutters**

Ref: G44144  
 See Page: 833



- Smooth Jaws
- Spring Loaded

Code	Description	UOM	Price
P48641	140mm (Smooth) Cousins Swiss Style, Spring Loaded	EACH	£15.95

**Flat Nose with Cutter**

High leverage plier has serrated flat jaws with built in cutter on the side which is capable of cutting ISO standard piano wire.

- Hard Wire Maximum Cutting Ø1.60mm
- Soft Wire Maximum Cutting Ø2.00mm
- Parallel Action Pliers
- Length: 140mm & 160mm
- One face with centre groove

**140mm (Serrated) Maun 4950.140**



- Maun 4950.140
- Parallel Action Pliers with Cutter
  - Flat nose with cutter
  - Serrated Jaws
  - Length 140mm
  - Hard Wire Maximum Cutting Ø1.60mm
  - Soft Wire Maximum Cutting Ø2.00mm

Code	Description	UOM	Price
P33206	140mm (Serrated) Maun 4950.140	EACH	£26.95

**160mm (Serrated) Maun 4950.160**



- Maun 4950.160
- Parallel Action Pliers with Cutter
  - Flat nose with cutter
  - Serrated Jaws
  - Length 160mm
  - Hard Wire Maximum Cutting Ø1.60mm
  - Soft Wire Maximum Cutting Ø2.00mm

Code	Description	UOM	Price
P33205	160mm (Serrated) Maun 4950.160	EACH	£28.95

**Snipe Nose**

Snipe nose pliers ideal for work in a confined space

- Parallel Action Pliers
- Length: 125 or 140mm
- Maximum Jaw Opening: 10mm
- Serrated or Smooth Jaws
- Maun or Cousins Swiss Style

**125mm (Serrated) Maun 4330.125**



- Maun 4330.125
- Parallel Action Pliers
  - Snipe nose
  - Serrated Jaws
  - Length: 125mm
  - Maximum Jaw Opening: 10mm

Code	Description	UOM	Price
P33211	125mm (Serrated) Maun 4330.125	EACH	£25.90

**125mm (Smooth) Maun 4340.125**



- Maun 4340.125
- Parallel Action Pliers
  - Snipe nose
  - Smooth Jaws
  - Length: 125mm
  - Maximum Jaw Opening: 10mm

Code	Description	UOM	Price
P33212	125mm (Smooth) Maun 4340.125	EACH	£25.90



**140mm (Serrated) Cousins Swiss Style**



- Cousins Swiss Style
- Parallel Action Pliers
  - Snipe nose
  - Serrated Jaws
  - Length: 140mm
  - Maximum Jaw Opening: 10mm

Code	Description	UOM	Price
P48589	140mm (Serrated) Cousins Swiss Style	EACH	£13.95

**140mm (Smooth) Cousins Swiss Style**



- Cousins Swiss Style
- Parallel Action Pliers
  - Snipe nose
  - Smooth Jaws
  - Length: 140mm
  - Maximum Jaw Opening: 10mm

Code	Description	UOM	Price
P48588	140mm (Smooth) Cousins Swiss Style	EACH	£13.95

**Haemostat Forceps**

Ref: S39496 See Page: 834

## PLIER SETS

Excellent range of sets of pliers, perfect for any every day workshop. With a set of pliers you ensure you will always have the plier you need.

### A\*F Swiss (Smooth) on Stand (x3)



A\*F Swiss

Set of 3, length 130mm, well finished in brush finish stainless steel. Blue PVC covered handles and double leaf springs, box joint smooth jaws on a wooden stand

Pliers:

- Flat, Smooth
- Round, Smooth
- Snipe, Smooth

Code	Description	UOM	Price
P47354	A*F Swiss (Smooth) on Stand	PACK*3	£29.95

### A\*F Swiss (Smooth) on Stand (x5)



A\*F Swiss

Set of 5, length 130mm, well finished in brush finish stainless steel. Blue PVC covered handles and double leaf springs, box joint smooth jaws on a wooden stand

Pliers:

- Flat, Smooth
- Round, Smooth
- Snipe, Smooth

Cutters:

- Side (Diagonal)
- End (Top)

Code	Description	UOM	Price
P47355	A*F Swiss (Smooth) on Stand	PACK*5	£57.50

### Bergeon 2513 (Smooth) on Stand



Pliers - On Wooden Stand - Bergeon 2513 - Swiss Made

Set of 3, length 115mm nickel plated steel pliers (smooth jaw) on a wooden stand, includes flat, half round and round nose pliers

Set of 3:

- Bergeon 2510 (P1248) Flat, Smooth
- Bergeon 2511 (P1245) Half Round, Smooth
- Bergeon 2512 (P1235) Round, Smooth

Code	Description	UOM	Price
P1249	Bergeon 2513 (Swiss) Set of 3	PACK*3	£81.95

### Bergeon 6283 (Serrated) on Stand



Pliers - On Wooden Stand - Bergeon 6283D - Swiss Made

Set of 6, length 130mm, nickel plated steel pliers (serrated jaw) & cutters on a wooden stand

Pliers (Smooth Jaw):

- Bergeon 2624 (P1236) Flat, Serrated
- Bergeon 2625D (P4773) Round, Serrated
- Bergeon 2626D (P1238) Snipe, Serrated

Cutters:

- Bergeon 2627 (P1254) Straight End
- Bergeon 2628 (P1255) Oblique End
- Bergeon 2629 (P1251) Side

Code	Description	UOM	Price
P1250	Bergeon 6283 (Serrated) on Stand	PACK*6	£194.50

### Bergeon 6283D (Smooth) on Stand



Pliers - On Wooden Stand - Bergeon 6283 - Swiss Made

Set of 6, length 130mm, nickel plated steel pliers (smooth jaw) & cutters on a wooden stand

Pliers (Smooth Jaw):

- Bergeon 2624D (P47379) Flat, Smooth
- Bergeon 2625D (P1237) Round, Smooth
- Bergeon 2626D (P4608) Snipe, Smooth

Cutters:

- Bergeon 2627 (P1254) Straight End
- Bergeon 2628 (P1255) Oblique End
- Bergeon 2629 (P1251) Side

Code	Description	UOM	Price
P47380	Bergeon 6283D (Smooth) on Stand	PACK*6	£194.95

### Value (Chunky Grip) Superior

VALUE



Pliers - Set of 4 - Chunky Grip - Superior

- Set of 4
- Sprung loaded, soft cushion arms
- Excellent grip
- Length 130mm
- Smooth jaws
- Supplied in leather case
- Great for beading, craft or designing work

Set Contains:

- Snipe - Flat Nose - Round Nose - Side Cutters
- Value cutters are only suitable for cutting material like solder, rubber, leather etc.

Code	Description	UOM	Price
P39486	Value (Chunky Grip) Superior	PACK*4	£19.95





Value (in pink case) Slim Line

VALUE



Pliers - Set of 5 - Pink

- Set of 5
- Slim line, length 115mm
- Box joint & sprung loaded
- Smooth jaw
- Supplied with pink case
- Wooden stand not included, Cousins reference P7985

Set Contains:

- Snipe
- Bent nose snipe
- Flat nose
- Round nose
- Side cutters
- Value cutters are only suitable for cutting material like solder, rubber, leather etc.

Pink Plier & Cutter Set:

Very useful as it is a "Slim Line" set ideal for delicate and intricate work. Very popular with students and ladies as these are not as bulky or heavy as your usual hand held pliers or cutters. Or it may be just be the colour!

Code	Description	UOM	Price
P32117	Value (in pink case) Slim Line	PACK*5	£17.95

Value (in plastic wallet)

VALUE



Pliers - Set of 4

- Set of 4
- Length 115mm
- Sprung loaded, sleeved arms
- Smooth jaws
- Supplied in plastic wallet

Set Contains:

- Snipe
- Flat Nose
- Round Nose
- Side Cutters
- Value cutters are only suitable for cutting material like solder, rubber, leather etc.

Code	Description	UOM	Price
P39487	Value (in plastic wallet) Set of 4	PACK*4	£10.95

(Forming) Plier Set of 4

VALUE



Pliers - Set of 4

- Set of 4
- Length 120mm
- Sleeved arms
- Smooth jaws

Set Contains:

- Curve forming - Concave & convex jaws
- Bend forming - Half round & flat jaws
- Loop shaping - round and concave jaws
- Bend forming - flat and round jaws

Code	Description	UOM	Price
P39488	Value Forming Plier Set	PACK*4	£10.95

RING CLAW & STONE REMOVING & SETTING PLIERS

Ring Claw & Stone Removing, A\*F Swiss



A\*F Swiss 180.576

Used for gripping the tips of prongs to remove stones from claw settings. Maximum control, minimum chance of damage. Box joint in polished steel, blue plastic coated handles.

- Sleeved arms
- Box joint
- Specific purpose hand tool, for prising open ring claws
- Spring loaded

Code	Description	UOM	Price
P1243	Ring Claw & Stone Removing, A*F Swiss	EACH	£25.95

PRICE PROMISE GUARANTEE

Setters Pliers, A\*F Swiss



A\*F Swiss

Special pliers for setters. Used for straightening the prongs of claw settings. One jaw is hollow and the other is set with a steel bead.

- Polished Steel
- Plastic covered handles
- Length 125mm

Code	Description	UOM	Price
P47131	Setters Pliers, A*F Swiss	EACH	£49.95

Stone Setting Pliers, A\*F Swiss



A\*F Swiss

These pliers have one long jaw with a smooth inner face and one short jaw with a groove carved lengthwise in the face. The groove is used to help contain one side of your setting, while the long jaw is used to bend the opposite prong in the setting into its final position.

Excellent in allowing you to control the pressure and therefore reducing the risk of slipping and damaging the stone.

- Polished steel
- Smooth jaws
- Plastic sleeved arms
- Length 125mm

Code	Description	UOM	Price
P47130	Stone Setting Pliers, A*F Swiss	EACH	£13.95

Stone Setting Pliers, Cousins Swiss Style



These stone-setting pliers have two bent jaws allowing

you to control the pressure and therefore reducing the risk of slipping and damaging the stone.

- Two bent nose jaws
- Spring loaded (double leaf springs)
- Stainless steel
- PVC coated handles
- Overall length 125mm
- Cousins Swiss Style
- Superb Swiss quality pliers

Code	Description	UOM	Price
P48640	Stone Setting Pliers, Cousins Swiss Style	EACH	£4.95

**Stone Setting Pliers, Parallel Action**



Cousins Swiss Style

Safely set stones with minimum effort and maximum control. Gem setting pliers close with a parallel motion so even pressure is applied when closing prongs and thus reduces the chance of damage to the stone. Jaws are easily adjusted by turning the opening adjustment wheel. 10:1 lever ratio allows you to set stones with less force than required with conventional pliers. The adjustment screw allows precise movement predetermined distance set by the jeweller. Works well with prongs and settings of all sizes and shapes. Easy to control and grip with the lever-action handle and limited travel distance. Simply adjust to fit the prong. Then gently squeeze to bend the prongs.

- Quickly & effectively set stones
- 10:1 pressure ratio, minimal effort required by the user
- Bends prongs accurately with its parallel jaw motion
- Ability to predetermine the distance you want the pliers to close to
- Maximum jaw opening 15mm
- Cousins Swiss Style
- Superb Swiss quality

Code	Description	UOM	Price
P48639	Gem Setting Plier	EACH	£14.95

**Stone Setting Pliers, Value**



These stone-setting pliers have a grooved slot in one jaw, allowing you to control the pressure and therefore reducing the risk of slipping and damaging the stone.

- One grooved, flat nose jaw
- One curved jaw
- Sleeved arms
- Overall length 125mm

Code	Description	UOM	Price
P39493	Stone Setting Pliers, Value	EACH	£4.50

**RING HOLDING PLIERS**

**Ring Holding (Nylon Jaws)**

For holding rings while polishing the inside or doing other work. The grooved nylon jaws hold rings or other circular objects securely without scratching.

- A\*F Swiss or Cousins Swiss Style
- With (Cousins Swiss Style) or without (A\*F) double leaf springs
- Polished Steel
- Blue Plastic Grips
- Length 140mm
- Replacement Jaws Available

**Ring Holding (Nylon Jaws), A\*F Swiss**



- A\*F Swiss 125.193
- Polished Steel
- Blue Plastic Grips
- Length 140mm
- Replacement Jaws Available

Code	Description	UOM	Price
P47125	Ring Holding (Nylon Jaws), A*F Swiss	EACH	£16.95

**Replacement Nylon Jaws, A\*F Swiss**

- A\*F Swiss
- Replacement Jaws
- for tool P47125



Code	Description	UOM	Price
P47126	Replacement Nylon Jaws, A*F Swiss	PAIR	£8.50



**Ring Holding (Nylon Jaws), Cousins Swiss Style**



- Cousins Swiss Style
- Superb Swiss quality pliers
- Polished Steel
- PVC coated arms
- Length 140mm
- Supplied with extra set of jaws

Code	Description	UOM	Price
P48577	Ring Holding (Nylon Jaws), Cousins Swiss Style	EACH	£9.95

**Replacement Nylon Jaws, Cousins Swiss Style**



- Cousins Swiss Style
- Replacement Jaws
- for tool P48577

Code	Description	UOM	Price
P48578	Replacement Nylon Jaws, Cousins Swiss Style	PAIR	£2.95

**Ring Holding (Steel Jaws)**

For holding rings while polishing the inside or doing other work. The hollow jaws hold the rings or other circular objects securely while the work is being done.

- Grooved jaws
- Stainless steel
- Sleeved arms
- A\*F or Cousins

**A\*F Swiss (145mm)**



- A\*F Swiss 125.192
- Brushed Satin Steel Finish
- Blue Plastic Grips

# PLIERS

• Length 145mm

Code	Description	UOM	Price
P47129	A*F Swiss (145mm)	EACH	£14.65

Value (150mm)

**VALUE**



- Grooved jaws
- Sleeved arms
- Jaws 40mm long
- Overall length 150mm

Code	Description	UOM	Price
P39489	Value (150mm)	EACH	£3.95

## ROSARY PLIERS

Rosary pliers are so-named because they are ideal for making rosary-style necklaces where each bead is put on a piece of wire with a wrapped loop at each end.

Your wire can be shaped and cut with this all in one tool. Create many designs to your own styles in keeping with today's trends. Rosary Jewellery has been worn for decades by the famous or anyone who's got the eye for fashionable jewellery

### Rosary Pliers

Rosary pliers are so-named because they are ideal for making rosary-style necklaces where each bead is put on a piece of wire with a wrapped loop at each end.

Your wire can be shaped and cut with this all in one tool. Create many designs to your own styles in keeping with today's trends. Rosary Jewellery has been worn for decades by the famous or anyone who's got the eye for fashionable jewellery

- Round jaws
- With cutter
- A\*F & Value

### Tool Rack Wall Mounted



Ref: S36086  
See Page: 781

A\*F Swiss (130mm)

**A\*F**  
SWITZERLAND



- A\*F Swiss 125.188
- Smooth Jaws
- Sleeved arms
- Length 130mm
- Fine Flush Tips

Code	Description	UOM	Price
P47533	A*F Swiss (130mm)	EACH	£23.95

Value (115mm) Chunky Grip

**VALUE**



- High quality carbon steel
- Leaf Springs
- Lap joint for better leverage
- Chunky, American style grip
- Length 115mm
- Fine tips
- With Cutter
- With wire stripper

Code	Description	UOM	Price
P40248	Value (115mm) Chunky Grip	EACH	£3.95

Value (130mm)

**VALUE**



- Smooth Jaws
- Sleeved arms
- Length 130mm
- Fine Flush Tips

Code	Description	UOM	Price
P35024	Value (130mm)	EACH	£3.95

PRICE PROMISE  
GUARANTEE



Value (155mm) Cushion Grip

**VALUE**



The set screw, just behind where the two handles are connected, controls how far the pliers can close. Setting them so that the pliers can only close to your preferred thickness can prevent "over breaking". Bearing ring lap joint design which one can tighten if the plier's action loosens. This ensures superior performance to other pliers.

- Cushion Grips
- Stainless Steel Leaf Springs
- Extra Long
- Length 155mm

Code	Description	UOM	Price
P35672	Value (155mm) Cushion Grip	EACH	£5.95

## ROUND NOSE PLIERS

- Serrated Jaws
- Smooth Jaws
- Smooth Jaws with Cutter

Both jaws have a round cross-section and taper to a fine point at the tips, making them great for getting into snug areas.

They are mainly used to curve wire for jump rings, chain making, filigree work and wire infolding.

### Round Nose Pliers

Both jaws have a round cross-section and taper to a fine point at the tips, making them great for getting into snug areas.

They are mainly used to curve wire for jump rings, chain making, filigree work and wire infolding.

A\*F, Bergeon, Cousins Swiss Style or Value

Available with:

- Serrated Jaws
- Smooth Jaws
- Smooth Jaws with Cutter
- Spring loaded
- Manual action
- Smart grip
- Chunky grip

## Tool Rack Organiser

**BEST  
SELLER**



Ref: T45704 See Page: 780

**A\*F Swiss (115mm) Smooth**



- A\*F Swiss 180.75
- Superior quality pliers
- Polished steel
- Box joint
- Blue plastic handles with double leaf springs.
- Round Nose
- Length 115mm

Code	Description	UOM	Price
P47353	A*F Swiss (115mm) Smooth	EACH	£16.95

**A\*F Swiss (115mm) Smooth, Smart Grip**



- A\*F Swiss 180.775
- Superb quality pliers
- Comfortable "Smart Grip" blue and black handles
- Round Nose
- Length 115mm

Code	Description	UOM	Price
P47343	A*F Swiss (115mm) Smooth, Smart Grip	EACH	£18.95

**A\*F Swiss (130mm) Smooth**



- A\*F Swiss 180.59SBL
- Superior quality pliers
- Polished steel
- Box joint
- Blue plastic handles with double leaf springs.
- Round Nose
- Length 130mm

Code	Description	UOM	Price
P47359	A*F Swiss (130mm) Smooth	EACH	£18.95

**A\*F Swiss (130mm) Smooth, Smart Grip**



- A\*F Swiss 180.759
- Superb quality pliers
- Comfortable "Smart Grip" blue and black handles
- Round Nose
- Length 130mm

Code	Description	UOM	Price
P47342	A*F Swiss (130mm) Smooth, Smart Grip	EACH	£17.95

**Bergeon (115mm) Smooth**



- Bergeon 2512
- Smooth box joint jaws
- Sleeved nickel plated arms
- Length 115mm
- Fine flush tips

Code	Description	UOM	Price
P1248	Bergeon (115mm) Smooth	EACH	£24.75

**Bergeon (130mm) Serrated**



- Bergeon 2625
- Serrated inner face, box joint jaws
- Sleeved arms
- Length 130mm
- Fine flush tips

Code	Description	UOM	Price
P4773	Bergeon (130mm) Serrated	EACH	£27.95

**Bergeon (130mm) Smooth**



- Bergeon 2625D
- Smooth box joint jaws
- Polished Steel
- Length 130mm
- Fine flush tips

Code	Description	UOM	Price
P1237	Bergeon (130mm) Smooth	EACH	£29.95

**Cousins Swiss Style (130mm) Smooth, Smart Grip**



- Cousins Swiss Style
- Superb Swiss quality pliers
- Comfortable "Smart Grip" blue and black handles
- Round Nose
- Length 130mm
- Spring loaded (double leaf springs)

Code	Description	UOM	Price
P48557	Cousins Swiss Style (130mm) Smooth, Smart Grip	EACH	£9.95

**Cousins Swiss Style (150mm) Smooth**



- Cousins Swiss Style



- Superb Swiss quality pliers
- PVC coated handles
- Round Nose
- Length 150mm
- Spring loaded (double leaf springs)

Code	Description	UOM	Price
P48564	Cousins Swiss Style (150mm) Smooth	EACH	£9.95

**Value (115mm) Smooth**

**VALUE**



- Smooth box joint jaws
- Spring loaded sleeved arms
- Length 115mm
- Fine tips

Code	Description	UOM	Price
P4783	Value (115mm) Smooth	EACH	£4.50

**Value (115mm) Smooth, Chunky Grip**

**VALUE**



- Smooth box joint jaws
- Spring loaded sleeved arms
- Length 115mm
- Fine tips

Code	Description	UOM	Price
P40247	Value (115mm) Smooth, Chunky Grip	EACH	£3.95

**Value (130mm) Smooth**

**VALUE**



- Smooth box joint jaws
- Sleeved arms
- Length 130mm

- Fine tips

Code	Description	UOM	Price
P4782	Value (130mm) Smooth	EACH	£3.95

**Value (140mm) Smooth, Long Nose**

**VALUE**



Long nose, long reach pliers; very useful, access awkward and hard to get too fiddly places with smooth box joint jaws and coated sleeved arms. Also to make loops, eye pins, French wire, clasps and jump rings, to make round, angled and curved bends in wire. Its serrated grip dramatically reduces slipping, making it ideal for holding components.

- Length 140mm
- Box Joint
- Sleeved Arms
- Fine Tips
- Smooth Jaws

Code	Description	UOM	Price
P32765	Value (140mm) Smooth, Long Nose	EACH	£4.75

**ROUND NOSE PLIERS (NYLON JAWS)**

**Round Nose Pliers (Nylon Jaws)**

**COUSINSUK**



Used for gripping and bending metal without damaging the surface. Fantastic for wire workers and beadsmiths. Box joint in polished stainless steel with replaceable nylon jaws.

- Nylon Jaw Pliers
- Round nose jaws to protect delicate, soft or polished jobs
- Length 125mm
- PVC coated handles
- Spring loaded (double leaf springs)
- Supplied with extra set of jaws
- Cousins Swiss Style
- Superb Swiss quality pliers

Code	Description	UOM	Price
P48571	Cousins Swiss Style (125mm) Nylon Jaws	EACH	£12.95
P48572	Replacement Jaws, Cousins Swiss Style	PAIR	£2.95

**ROUND & CONCAVE NOSE PLIERS**

**Round & Concave Jaw Pliers**

Pliers for making sharp loops and bends in wire or sheet metal. Ideal for jump rings and split rings. One jaw round, the other concave. Box joint.

A\*F, Bergeon, Cousins Swiss Style or Value

- Round & concave jaws
- Deeply cupped jaw with round former
- Sleeved arms
- Box joint
- Polished steel

**A\*F Swiss (125mm)**

**A\*F SWITZERLAND**

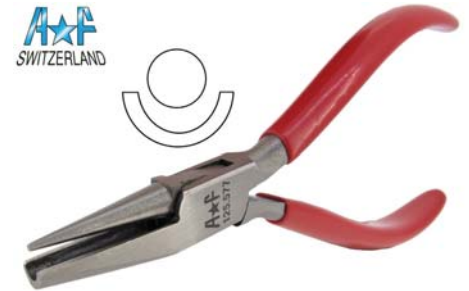

- A\*F Swiss 125.577
- Round & concave jaws
- Deeply cupped jaw with round former
- Sleeved arms
- Box joint
- Polished steel
- Length 125mm
- 6mm wide cup jaw

Code	Description	UOM	Price
P47362	A*F Swiss (125mm)	EACH	£23.95

**Bergeon (130mm)**

**BERGEON**



- Bergeon 5829
- Deeply cupped jaw with round former
- Sleeved arms
- Box joint
- Length 130mm
- 6mm wide cup jaw

Code	Description	UOM	Price
P4384	Bergeon (130mm)	EACH	£39.95



**Online Discounts**

**WORLDWIDE DELIVERY**

**Cousins Swiss Style (140mm), Multi Size**



- Cousins Swiss Style
- Superb Swiss quality pliers
- Round & concave jaws
- 3 round sizes, Ø3, 4.5 & 5.5mm
- Deeply cupped jaw with stepped round former
- PVC coated arms
- Box joint
- Polished steel
- Length 140mm
- Spring loaded (double leaf springs)

Code	Description	UOM	Price
P48590	Cousins Swiss Style (140mm), Multi Size	EACH	£12.95

**Value (130mm)**



- Round & concave jaws
- Deeply cupped jaw with round former
- Sleeved arms
- Box joint
- Length 130mm
- 6mm wide cup jaw

Code	Description	UOM	Price
P4785	Value (130mm)	EACH	£3.95

**ROUND & FLAT NOSE PLIERS**

**Round & Flat Nose Pliers**

Ideal for bending rings or producing curves. With polished steel jaws, one flat and one round. Box joint and plastic covered handles.

A\*F, Bergeon, Cousins Swiss Style or Value

- Jewellery making
- Combined flat and round profiles
- Sleeved arms
- Box joint

**Bend & Ring Forming, A\*F Swiss**



- A\*F Swiss 125.581
- Jewellery making etc
- Combined flat and half round profiles
- Sleeved arms
- Box joint
- Length 130mm

Code	Description	UOM	Price
P47363	Bend & Ring Forming, A*F Swiss	EACH	£21.95

**Bergeon (130mm)**



- Bergeon 5831
- Jewellery making etc
- Combined flat and round profiles
- Sleeved arms
- Box joint
- Length 130mm
- 5mm wide top

Code	Description	UOM	Price
P4385	Bergeon (130mm)	EACH	£34.95

**Value (130mm)**

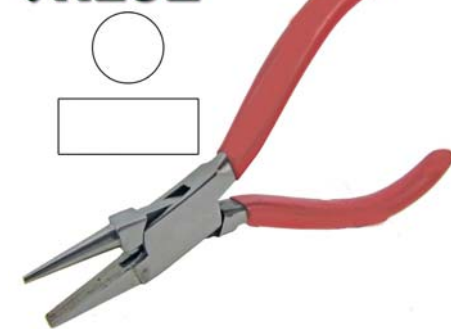

- Jewellery making etc
- Combined flat and round profiles
- For finer application
- Sleeved arms
- Box joint
- Length 130mm

- 6mm wide tip and fine nose

Code	Description	UOM	Price
P4786	Value (130mm)	EACH	£5.95

**ROUND & FLAT NOSE PLIERS (NYLON JAWS)**

**Round & Flat Nose Pliers (Nylon Jaws)**

Ideal for bending rings or producing curves. With one polished steel jaw and one nylon (plastic) jaw, one flat and one round. Box joint and plastic covered handles.

A\*F, Cousins Swiss style or Value

- Jewellery making
- Combined flat and round profiles
- Sleeved arms
- Box joint
- Nylon flat nose jaw
- Nylon jaws ensure delicate items/soft precious metals are not marked

**A\*F Swiss (140mm) Nylon Jaws**



- A\*F Swiss
- Highly polished stainless steel
- One nylon flat nose jaw for extra protection of delicate materials
- One round nose jaw
- Sleeved arms
- 24mm Jaw Width
- Overall length 140mm
- Replacement nylon jaws available

Code	Description	UOM	Price
P47127	A*F Swiss (140mm) Nylon Jaws	EACH	£29.95

**A\*F Swiss (140mm) Replacement Jaws**

- A\*F Swiss
- Replacement nylon jaws
- 24mm Jaw Width
- for tool P47127



Code	Description	UOM	Price
P47128	A*F Swiss (140mm) Replacement Jaws	PAIR	£2.95

**Shears, Snips & Cutters**  
See Page 830

**Cousins Swiss Style (140mm) Nylon Jaws**



- Cousins Swiss Style
- Highly polished stainless steel
- One nylon flat nose jaw for extra protection of delicate materials
- One round nose jaw
- PVC coated arms
- Overall length 140mm
- Spring loaded (double leaf springs)
- Supplied with extra set of jaws
- Cousins Swiss Style
- Superb Swiss quality pliers

Code	Description	UOM	Price
P48614	Cousins Swiss Style (140mm) Nylon Jaws	EACH	£16.95

**Cousins Swiss Style (140mm) Replacement Jaws**



- Cousins Swiss Style
- Replacement nylon jaws
- 24mm Jaw Width
- for tool P48614 & P48618

Code	Description	UOM	Price
P48619	Cousins Swiss Style (140mm) Replacement Jaws	EACH	£1.95

**Value (140mm) Nylon Jaws**



- Plastic Jaw, Bend Forming
- One plastic flat nose jaw for extra protection of delicate glass
- One round nose jaw
- Sleeved arms
- Overall length 140mm

Code	Description	UOM	Price
P39491	Value (140mm) Nylon Jaws	EACH	£4.75

**PRICE PROMISE GUARANTEE**

**SNIBE NOSE (HALF ROUND) PLIERS**

- Serrated Jaws
- Smooth Jaws
- Smooth Jaws with Bent Nose
- Smooth Jaws with Cutter

Suited for effortlessly getting into snug areas and any precision work. Cross section of the jaws is flat where they meet and rounded on the outside. Jaws taper to fine point. These pliers are valuable for opening small jump rings, bending thin gauge wire and holding small beads.

**Snipe Nose (Half Round) Pliers**

Suited for effortlessly getting into snug areas and any precision work. Cross section of the jaws is flat where they meet and rounded on the outside. Jaws taper to fine point. These pliers are valuable for opening small jump rings, bending thin gauge wire and holding small beads.

Types available:

- Serrated Jaws
- Smooth Jaws
- Smooth Jaws with Bent Nose
- Smooth Jaws with Cutter
- Spring loaded
- Manual action
- Extra long
- Smart grip
- Rosary
- Extra Long
- Cushion grip

**A\*F Swiss (115mm) Serrated**



- A\*F Swiss 180.74S
- Superior quality pliers
- Polished steel
- Box joint
- Blue plastic handles with double leaf springs
- Serrated jaws
- Snipe Nose
- Length 115mm

Code	Description	UOM	Price
P47352	A*F Swiss (115mm) Serrated	EACH	£21.95

**Emery Sticks - All Shapes**

See Page 1148



**A\*F Swiss (115mm) Smooth**



- A\*F Swiss 180.74
- Superior quality pliers
- Polished steel
- Box joint
- Blue plastic handles with double leaf springs
- Smooth jaws
- Snipe Nose
- Length 115mm

Code	Description	UOM	Price
P47351	A*F Swiss (115mm) Smooth	EACH	£18.95

**A\*F Swiss (115mm) Smooth, Smart Grip**



- A\*F Swiss 180.774
- Superb quality pliers
- With comfortable "Smart Grip" blue and black handles
- Polished steel
- Box joint
- Smooth jaws
- Snipe Nose
- Length 115mm

Code	Description	UOM	Price
P47345	A*F Swiss (115mm) Smooth, Smart Grip	EACH	£17.40

**A\*F Swiss (130mm) Smooth**



- A\*F Swiss 180.60SBL
- Superior quality pliers
- Polished steel
- Box joint
- Blue plastic handles with double leaf springs
- Smooth jaws
- Snipe Nose
- Length 130mm

Code	Description	UOM	Price
P47360	A*F Swiss (130mm) Smooth	EACH	£17.95

**A\*F Swiss (130mm) Smooth, Smart Grip**



- A\*F Swiss 180.760
- Superb quality pliers
- With comfortable "Smart Grip" blue and black handles
- Polished steel
- Box joint
- Smooth jaws
- Snipe Nose
- Length 130mm

Code	Description	UOM	Price
P47344	A*F Swiss (130mm) Smooth, Smart Grip	EACH	£16.95

**Bergeon (115mm) Smooth**

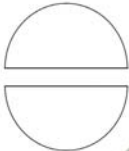

- Bergeon 2511
- Smooth box joint jaws
- Sleeved nickel plated arms
- Length 115mm
- Fine half round tips

Code	Description	UOM	Price
P1245	Bergeon (115mm) Smooth	EACH	£23.75

**Bergeon (115mm) Serrated**

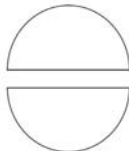

- Bergeon 2626
- Serrated box joint jaws
- Sleeved arms
- 26mm joint to tips
- Length 130mm
- Fine half round tips

Code	Description	UOM	Price
P1238	Bergeon (115mm) Serrated	EACH	£23.75

**Bergeon (130mm) Smooth**



- Bergeon 2626D
- Smooth box joint jaws
- Sleeved arms
- 26mm joint to tips
- Length 130mm
- Fine half round tips

Code	Description	UOM	Price
P4608	Bergeon (130mm) Smooth	EACH	£27.95

**Cousins Swiss Style (130mm) Smooth, Smart Grip**



- Cousins Swiss Style
- Superb Swiss quality pliers
- With comfortable "Smart Grip" blue and black handles
- Polished steel
- Box joint
- Smooth jaws
- Snipe Nose
- Length 130mm
- Spring loaded (double leaf springs)

Code	Description	UOM	Price
P48559	Cousins Swiss Style (130mm) Smooth, Smart Grip	EACH	£9.95

**Cousins Swiss Style (130mm) Smooth, Smart Grip, Bent Nose**



- Cousins Swiss Style
- Superb Swiss quality pliers
- With comfortable "Smart Grip" blue and black handles

- Polished steel
- Box joint
- Smooth jaws
- Bent snipe Nose
- Length 130mm
- Spring loaded (double leaf springs)

Code	Description	UOM	Price
P48560	Cousins Swiss Style (130mm) Smooth, Smart Grip, Bent Nose	EACH	£11.95

**Cousins Swiss Style (150mm) Smooth**



- Cousins Swiss Style
- Superb Swiss quality pliers
- PVC coated handles
- Polished steel
- Box joint
- Smooth jaws
- Snipe nose
- Length 150mm
- Spring loaded (double leaf springs)

Code	Description	UOM	Price
P48566	Cousins Swiss Style (150mm) Smooth	EACH	£9.95

**Cousins Swiss Style (160mm) Smooth, Long Nose**



- Cousins Swiss Style
- Superb Swiss quality pliers
- PVC coated handles
- Polished steel
- Box joint
- Smooth jaws
- Snipe nose
- Extra long nose
- Length 160mm
- Spring loaded (double leaf springs)

Code	Description	UOM	Price
P48567	Cousins Swiss Style (160mm) Smooth, Long Nose	EACH	£11.95

www. Online Discounts



Value (115mm) Smooth

**VALUE**



- Smooth box joint jaws
- Spring loaded sleeved arms
- Length 115mm
- Fine half round tips

Code	Description	UOM	Price
P4780	Value (115mm) Smooth	EACH	£3.50

Value (130mm) Serrated

**VALUE**



- Serrated box joint jaws
- Sleeved arms
- Length 130mm
- Fine half round tips

Code	Description	UOM	Price
P4781	Value (130mm) Serrated	EACH	£5.85

awkward and hard to get too fiddly places with smooth spring loaded joint jaws and heavy duty, American style grip, coated, sleeved arms plus cutter.

- High quality carbon steel
- Spring loaded sleeved arms
- Lap joint for better leverage
- Chunky, American style grip
- Serrated Jaws
- with Cutter
- Length 130mm

Code	Description	UOM	Price
P40244	Value (130mm) Serrated, Long Nose, Chunky Grip with Cutter	EACH	£3.95

Value (115mm) Smooth, Bent Nose

**VALUE**



- 115mm
- Sprung Loaded
- Plastic Coated Handles
- Smooth Jaw

Code	Description	UOM	Price
P31383	Value (115mm) Smooth, Bent Nose	EACH	£4.35

Value (130mm) Serrated, Long Nose, Chunky Grip

**VALUE**



Long Nose, long reach pliers; very useful, access awkward and hard to get too fiddly places with smooth spring loaded joint jaws and heavy duty, American style grip, coated, sleeved arms.

- High quality carbon steel
- Spring loaded sleeved arms
- Lap joint for better leverage
- Chunky, American style grip
- Serrated Jaws
- Length 130mm

Code	Description	UOM	Price
P40245	Value (130mm) Serrated, Long Nose, Chunky Grip	EACH	£3.95

Value (130mm) Smooth

**VALUE**



- Smooth box joint jaws
- Sleeved arms
- Length 130mm
- Fine half round tips

Code	Description	UOM	Price
P4779	Value (130mm) Smooth	EACH	£5.95

Value (125mm) Smooth, Rosary

**VALUE**



- Smooth jaws
- Spring loaded sleeved arms
- 25mm joint to tips
- Length 125mm
- Fine half round tips

Code	Description	UOM	Price
P35023	Value (125mm) Smooth, Rosary	EACH	£3.95

Value (130mm) Smooth, Bent Nose & Chunky Grip

**VALUE**



- High quality carbon steel
- Spring loaded sleeved arms
- Lap joint for better leverage
- Chunky, American style grip
- Length 130mm
- Bent tips

Code	Description	UOM	Price
P40250	Value (130mm) Smooth, Bent Nose & Chunky Grip	EACH	£3.95

Value (130mm) Serrated, Long Nose, Chunky Grip with Cutter

**VALUE**



Long Nose, long reach pliers; very useful, access

PRICE PROMISE GUARANTEE

**SECURE** ONLINE ORDERING

Online Order Tracking



**WORLDWIDE DELIVERY**

**Value (130mm) Smooth, Long Nose, Chunky Grip with Cutter**

**VALUE**



Long Nose, long reach pliers; very useful, access awkward and hard to get too fiddly places with smooth spring loaded joint jaws and heavy duty, American style grip, coated, sleeved arms plus cutter.

- High quality carbon steel
- Spring loaded sleeved arms
- Lap joint for better leverage
- Chunky, American style grip
- Smooth Jaws
- with Cutter
- Length 130mm

Code	Description	UOM	Price
P40246	Value (130mm) Smooth, Long Nose, Chunky Grip with Cutter	EACH	£3.95

**Value (140mm) Serrated, Long Nose**

**VALUE**



Long nose, long reach pliers; very useful, access awkward and hard to get too fiddly places with smooth box joint jaws and coated sleeved arms. Also to open and close jump rings, close prongs, flat crimping, closing bead tips, holding components and making angle bends.

Its serrated grip dramatically reduces slipping, making it ideal for holding components.

- Length 140mm
- Box Joint
- Sleeved Arms
- Fine Tips
- Serrated Jaws

Code	Description	UOM	Price
P32764	Value (140mm) Serrated, Long Nose	EACH	£4.75



**BROWSE & BUY**



**BROWSE & BUY**

**Value (140mm) Smooth, Long Nose**

**VALUE**



Long nose, long reach pliers; very useful, access awkward and hard to get too fiddly places with smooth box joint jaws and coated sleeved arms. Also to open and close jump rings, close prongs, flat crimping, closing bead tips, holding components and making angle bends.

- Length 140mm
- Box Joint
- Sleeved Arms
- Fine Tips
- Smooth Jaws

Code	Description	UOM	Price
P32763	Value (140mm) Smooth, Long Nose	EACH	£4.75

**Value (155mm) Smooth, Bent Nose**

**VALUE**



- Bearing ring lap joint design which one can tighten if the plier's action loosens. This ensures superior performance to other pliers.
- Cushion grips with stainless steel leaf springs.
- The set screw, just behind where the two handles are connected, controls how far the pliers can close. Setting them so that the pliers can only close to your preferred thickness can prevent "over breaking".
- Length 155mm

Code	Description	UOM	Price
P35671	Value (155mm) Smooth, Bent Nose	EACH	£5.95

**Value (155mm) Smooth, Long Nose**

**VALUE**



- Jaw length 50mm
- Overall length 155mm
- Polished steel
- Yellow plastic covered handles
- Box joint
- Spring loaded arms

Code	Description	UOM	Price
P36111	Value (155mm) Smooth, Long Nose	EACH	£5.95

**SNIFE NOSE (HALF ROUND) PLIERS (NYLON JAWS)**

**Snipe Nose Pliers (Nylon Jaws)**

**COUSINSUK**



Used for gripping and bending metal without damaging the surface. Also used by opticians for adjusting spectacle frames. Box joint in polished stainless steel with replaceable nylon jaws.

- Nylon Jaw Pliers
- Nylon jaws to protect delicate, soft or polished jobs
- Length 125mm
- Spring loaded (double leaf springs)
- Supplied with extra set of jaws
- Cousins Swiss Style
- Superb Swiss quality pliers

Code	Description	UOM	Price
P48569	Cousins Swiss Style (125mm) Nylon Jaws	EACH	£12.95
P48570	Replacement Jaws, Cousins Swiss Style	PAIR	£2.95

**SPLIT RING & CHAIN LINK PLIERS**

**Split Ring & Chain Link Pliers**

Finally, split ring pliers that actually work! Curved catch tip opens ring then securely grasps it, simplifying installation

- Split ring & chain link pliers
- Curved catch tip jaws
- A\*F Swiss, Cousins Swiss Style or Xuron USA

**A\*F Swiss (Split Ring & Chain Link)**

**A\*F SWITZERLAND**



A\*F Swiss

Specialist pliers for opening split rings etc. High quality with a brushed steel finish. Wide lower (5mm+) jaw ideal for positioning items ready to be split.

- Polished steel
- Plastic covered handles

- Length 135mm

Code	Description	UOM	Price
P47132	A*F Swiss (Split Ring & Chain Link)	EACH	£55.50

**Cousins Swiss Style (Split Ring & Chain Link)**



- Cousins Swiss Style
- Finally, split ring pliers that actually work!
  - Jump ring closing
  - Curved catch tip opens ring then securely grasps it, simplifying installation
  - Steel jaws jaws
  - PVC coated handles
  - Overall length 130mm
  - Spring loaded (double leaf springs)
  - Cousins Swiss Style
  - Superb Swiss quality pliers

Code	Description	UOM	Price
P48855	Cousins Swiss Style (Split Ring & Chain Link)	EACH	£7.95

**Cousins Swiss Style (Split Ring & Chain Link)**



- Cousins Swiss Style
- Finally, split ring pliers that actually work!
  - Jump ring closing
  - Curved catch tip opens ring then securely grasps it, simplifying installation
  - Black powder coated steel jaws jaws
  - Smart grip plastic coated handles
  - Overall length 130mm
  - Spring loaded
  - Cousins Swiss Style
  - Superb Swiss quality pliers

Code	Description	UOM	Price
P48631	Cousins Swiss Style (Split Ring & Chain Link)	EACH	£12.95

**9ct & Silver Split Rings**  
See Page 52

**Xuron 496, Split Ring & Chain Link**



- Xuron 496
- Finally, split ring pliers that actually work!
  - Jump ring closing
  - Curved catch tip opens ring then securely grasps it, simplifying installation
  - Ergonomic design, non-slip Xuron-Rubber™ grips and light weight make it easy to use
  - Will close 20mm to 0.5 mm spit rings

Code	Description	UOM	Price
P33332	Xuron 496, Split Ring & Chain Link	EACH	£7.05

**TONGS, SLIDING**

**Sliding Tongs, Grooved Jaws**



- A\*F Swiss
- Forged in toughened steel with a brushed steel finish, with grooves and a small round recess inside the tips of the jaws for holding small screws, pins etc.
- Forged in toughened steel
  - Box joint for extra strength
  - Very good quality
  - With grooves inside the tips of the jaws
  - With spring and locking ring
  - Length 120mm
  - Jaw Tip Outer Width Ø3.0mm
  - Weight 80g

Code	Description	UOM	Price
T47198	Sliding Tongs, Grooved jaws	EACH	£84.95

**Sliding Tongs, for Small Parts**



- A\*F Swiss
- Forged in toughened steel, round nose flat inside for holding small parts

- Box joint for extra strength
- Very good quality
- With spring and locking ring
- Length 120mm
- Weight 75g

Code	Description	UOM	Price
P47364	Sliding Tongs, for Small Parts	EACH	£79.95

**TUBE HOLDING & CUTTING PLIERS**

**Tube Holding (Nylon Jaws)**



- Used for holding tubing gently but firmly whilst cutting, filing or soldering. Jaws are designed to hold up to 11 different diameters of tubing easily & comfortably. Box joint in polished stainless steel with replaceable nylon jaws.
- Nylon Jaw Pliers
  - 11 different tube diameter holding grooves (Ø1.40 to Ø3.70mm)
  - Length 160mm
  - PVC coated handles
  - Spring loaded (double leaf springs)
  - Supplied with extra set of jaws
  - Cousins Swiss Style
  - Superb Swiss quality pliers

Code	Description	UOM	Price
P48575	Tube Holding (Nylon Jaws), Cousins Swiss Style	EACH	£11.95
P48576	Replacement Jaws, Cousins Swiss Style	PAIR	£2.95

**Tube Holding & Cutting (Steel Jaws)**



- Used for holding tubing & rods firmly whilst sawing/ cutting, filing or soldering. The stainless steel jaws

feature a slit down the middle for your saw blade to follow, making cutting simple, quick and accurate. Box joint in polished stainless steel with steel jaws

- Tube holding & cutting pliers
- Will hold tubing from Ø2 to Ø6mm outside diameter
- Length 165mm
- PVC coated arms
- Spring loaded (double leaf springs)
- Cousins Swiss Style
- Superb Swiss quality pliers

Code	Description	UOM	Price
P48637	Tube Holding (Steel Jaws), Cousins Swiss Style	EACH	£14.95

## V BLOCK JAW PLIERS

### V Block Jaw Pliers

These are traditional ring forming pliers used for generations.

Simply place your wire/band into the pliers, press down and notice how easy the pliers start rounding items. After the wire/ring is formed, place on triblet to finish.

- High quality forged steel
- Ideal, fast & easy to use
- Heavy duty curve forming tips
- Can also reshape deformed rings
- Box joint, sleeved
- A\*F, Bergeon or value

### A\*F Swiss (160mm) Heavy Duty



Heavy duty for bending the toughest rings and also closing watch bows. Well finished in forged steel with box joint. Extra long, plastic covered handles for maximum leverage.

- A\*F Swiss 125.190
- High quality forged steel
- Ideal, fast & easy to use
- Heavy duty curve forming tips
- Length 160mm
- Can also reshape deformed rings
- Box joint, sleeved

Code	Description	UOM	Price
P47114	A*F Swiss (160mm) Heavy Duty	EACH	£43.85

### Tool Rack Wall Mounted



Ref: S36086  
See Page: 781

### Bergeon (160mm)



- Bergeon 6346
- Ring shaping etc
- Heavy Duty curve forming tips
- Reshapes deformed rings
- Length 160mm
- Box joint, sleeved

Code	Description	UOM	Price
P1244	Bergeon (160mm)	EACH	£49.95

### Value (160mm)

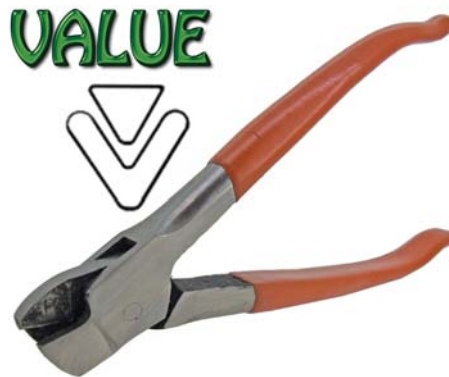

- Ideal, fast & easy to use
- Can also reshape deformed rings
- Made from a good grade steel
- Hand made construction
- Coated sleeves
- Length 160mm

Code	Description	UOM	Price
P36110	Value (160mm)	EACH	£5.95

### Value (180mm)



- Stainless steel
- Forged, machined construction
- Ideal, fast & easy to use
- Coated handles
- Length 180mm
- Can also reshape deformed rings

Code	Description	UOM	Price
P46149	Value (180mm)	EACH	£14.50

## V BLOCK JAW PLIERS (NYLON JAWS)

### V Block with V Jaw Pliers (Nylon Jaws)



For a more harsh curving that the traditionally shaped pliers, this plier is often used for reshaping rings and sheet metal. The tool will never scratch any soft precious metal since the holding block is in nylon and the V shaped jaw is in highly polished stainless steel. The handles are covered in blue plastic.

- "V" shaped steel jaw
- "V" shaped nylon holding block
- Single jaw is in highly polished stainless steel
- Length 150mm
- PVC coated handles
- Suppled with extra nylon jaw
- Cousins Swiss Style
- Superb Swiss quality pliers

Code	Description	UOM	Price
P48622	Cousins Swiss Style (140mm) V Block with V Jaw (Nylon Jaw)	EACH	£14.95
P48623	Cousins Swiss Style Replacement Nylon V Block	EACH	£2.95

### V Block with U Jaw Pliers (Nylon Jaws)

This plier is an eminently superior replacement for the three-jawed plier known as a bow-closing plier which is often used for reshaping rings. This tool however, will never scratch a ring since the "V" block is in nylon and the single jaw is in highly polished stainless steel. The handles are covered in blue plastic.

A\*F or Cousins Swiss Style

- "U" shaped steel jaw
- "V" shaped nylon holding block
- Single jaw is in highly polished stainless steel
- Length 140mm
- Box joint
- Blue PVC coated handles
- Replacement V block available (23 x 19mm)

## Tool Rack Organiser



Ref: T45704 See Page: 780

**A\*F Swiss (140mm) V Block with U Jaw (Nylon Jaw)**



- A\*F Swiss
- "V" block is in nylon
  - Single jaw is in highly polished stainless steel
  - Length 140mm
  - Replacement V block available (23 x 19mm)

Code	Description	UOM	Price
P47123	A*F Swiss (140mm) V Block with U Jaw (Nylon Jaw)	EACH	£19.95

**A\*F Swiss Replacement Nylon V Block**



- A\*F Swiss
- Replacement "V" Block Nylon Jaw
  - Overall Size 23 x 19mm

Code	Description	UOM	Price
P47124	A*F Swiss Replacement Nylon V Block	EACH	£2.95

**Cousins Swiss Style (140mm) V Block with U Jaw (Nylon Jaw)**



- Cousins Swiss Style
- "V" block is in nylon
  - Single jaw is in highly polished stainless steel
  - Length 140mm
  - Replacement V block available (23 x 19mm)

Code	Description	UOM	Price
P48573	Cousins Swiss Style (140mm) V Block with U Jaw (Nylon Jaw)	EACH	£16.95

**Cousins Swiss Style Replacement Nylon V Block**



- Cousins Swiss Style
- Replacement "V" Block Nylon Jaw
  - Overall Size 23 x 19mm

Code	Description	UOM	Price
P48623	Cousins Swiss Style Replacement Nylon V Block	EACH	£2.95

**WIRE BENDING & WRAPPING PLIERS**

Curving & Wire Bending Pliers, Value

**VALUE**



Wire Bending Pliers

- Great for bending fiddly wire
- Sleeved arms
- Indentations in the jaws for easy holding of wires
- Length 135mm

Code	Description	UOM	Price
P39498	Wire Bending Plier	EACH	£4.95

**Round & Snipe Jaws Wire Wrapping Pliers**



Make the perfect round loop every time!

- 1 round (multisize) jaw and one snipe nose jaw
- Ø3, 4.5 & 5.5mm
- PVC coated handles
- Overall length 150mm
- Spring loaded (double leaf springs)
- Cousins Swiss Style
- Superb Swiss quality pliers

Code	Description	UOM	Price
P48591	Round Loop Making, Cousins Swiss Style	EACH	£9.95

**SECURE** **ONLINE ORDERING**

**IMPROVED SPEED SEARCH**

**Round Jaws Wire Wrapping Pliers**



Make the perfect round loop every time!

- 2 round jaws
- Ø2 to Ø9mm
- Round nose
- PVC coated handles
- Overall length 150mm
- Spring loaded (double leaf springs)
- Cousins Swiss Style
- Superb Swiss quality pliers

Code	Description	UOM	Price
P48592	Round Loop Making, Cousins Swiss Style	EACH	£12.95

**Round Jaws Wire Wrapping Pliers, Gauged**



Make the perfect measured round loop every time!

- 2 round jaws
- Ø2 to Ø8mm
- Jaws are clearly marked with the sizes for ease of reference
- Spring loaded (double leaf springs)
- PVC coated handles
- Overall length 165mm
- Cousins Swiss Style
- Superb Swiss quality

Code	Description	UOM	Price
P48849	Round Loop Making, Cousins Swiss Style Gauged	EACH	£16.95

**Forming Mandrels**

See Page: 897



**Square Jaws Wire Wrapping Pliers, Gauged**



Make the perfect measured square loop every time!

- 2 square jaws
- 2 to 8mm
- Jaws are clearly marked with the sizes for ease of reference
- Spring loaded (double leaf springs)
- PVC coated handles
- Overall length 165mm
- Cousins Swiss Style
- Superb Swiss quality

Code	Description	UOM	Price
P48850	Square Loop Making, Cousins Swiss Style Gauged	EACH	£15.95

**WRAPPING PLIERS**

**Wrapping Pliers**



A revolutionary, yet simple idea, these wrap "n" tap ring pliers are extremely effective and were invented and patented by a master jeweller.

We call them Wrap "n" Tap Ring Pliers because the jeweller can wrap ring stock around the barrel shaped jaw then tap it slightly on a mandrel and instantly make a complete ring half or quarter shank for repair. The pliers are especially good for hollow rings and rings with a design on one side because the lower jaw is covered with PVC tubing and cannot scratch or mar. You get a perfect circle time after time with stock up to 2mm thick. Made of stainless steel with PVC cushion grips.

- Ø14 or Ø19mm barrel
- Also with a flat, PVC sleeved jaw for extra protection
- Wrap sheet up to 2mm thick
- Spring loaded (double leaf springs)
- Stainless steel
- PVC coated handles
- Overall length 150mm
- Cousins Swiss Style

• Superb Swiss quality pliers

Code	Description	UOM	Price
P48629	Ø14mm Barrel Cousins Swiss Style	EACH	£13.95
P48630	Ø19mm Barrel Cousins Swiss Style	EACH	£14.50

**Wrapping Pliers, Multi Size**



Offering even greater versatility than our standard wrapping pliers!

A revolutionary, yet simple idea, these wrap "n" tap ring pliers are extremely effective and were invented and patented by a master jeweller.

We call them Wrap n Tap Ring Pliers because the jeweller can wrap ring stock around the barrel shaped jaw then tap it slightly on a mandrel and instantly make a complete ring half or quarter shank for repair. You get a perfect circle time after time with stock up to 2mm thick. Made of stainless steel with PVC coated grips.

- Multi size stepped round nose barrels
- Bottom jaw is flat
- Wrap sheet up to 2mm thick
- Stainless steel
- PVC coated handles
- Overall length 150 (P48593) & 165mm (P48594)
- Cousins Swiss Style
- Superb Swiss quality pliers

Code	Description	UOM	Price
P48593	Ø5, 7 & 10mm Cousins Swiss Style	EACH	£11.95
P48594	Ø13, 16 & 20mm Cousins Swiss Style	EACH	£12.95

**XURON (USA MADE) PLIERS**



*Timeless engineered hand tools*

*Made in U S A*

*Xuron are considered the best of the best in its range of pliers and cutters in the world, take a glance at our large range, there is always something to suit you.*

*Xuron Corporation is one of the world's leading manufacturers of ergonomic precision-grade hand tools for jewellery, silversmith arts/craft model maker, electronics, aerospace, plastic moulding, hobbies, craft, floral and fishing Industries.*

*Xuron tools are manufactured in Saco, Maine, where quality, an outstanding work ethic and flawless craftsmanship are a long-time tradition*

*Xuron pliers are designed to deliver high precision at reasonable cost. Primary design criteria are precision, ergonomics and durability. They feature advanced ergonomic design, Xuron-Rubber™ cushion grips, light weight, a glare eliminating black finish and our Light Touch™ return spring.*

**Xuron (USA Made) Pliers**

Xuron - USA Made

Pliers for jewellery & beading creation, horological and many other. Experience the comfort of exclusive cushioned grips, return springs and long lasting tips.

Xuron pliers create a new standard of price-performance excellence.

The shape, size and feel of the grip surface provides comfortable performance.

The automatic return spring saves time and effort.

Features:

- Serrated or Smooth
- Precision Machining
- Light-touch Return Spring
- Xuro-Rubber Comfort Grips

**Xuron 450 (Tweezer Nose) Smooth**



- The 450 is an ultra precise needle nose pliers are capable of grasping and holding wire less than 1mm thick with the strength for wire forming
- Leads "popping" free, tip misalignment and blade crossover will be a memory once you switch to the Tweezers Nose™ pliers
- Radiused edges protect lead wires
- Light weight and patented, non-protruding, Light Touch™ return spring help ensure operator comfort

Code	Description	UOM	Price
P33330	Xuron 450 (Tweezer Nose) Smooth	EACH	£8.45

**Brass & Steel Wire**

See Page 1161

**Mitre / Jewellers Jig**

See Page 831

**Xuron 450BN (Bent Nose) Smooth**



- The ultimate bent needle nose pliers
- Six separate milling operations on each pliers nose ensures the blades match in size, shape and alignment
- Tweezer nose™ pliers combine the precision to pick up a human hair with the strength required for wire forming operations
- Cushioned Xuron-Rubber™ grips and our Light Touch™ return spring speed use, enhance control and make the pliers more comfortable in your hand

Code	Description	UOM	Price
P33228	Xuron 450BN (Bent Nose) Smooth	EACH	£9.80

**Xuron 450S (Tweezer Nose) Serrated**



- The 450 is an ultra precise needle nose pliers are capable of grasping and holding wire less than 1mm thick with the strength for wire forming
- Leads "popping" free, tip misalignment and blade crossover will be a memory once you switch to the Tweezers Nose™ pliers
- Radiused edges protect lead wires
- Light weight and patented, non-protruding, Light Touch™ return spring help ensure operator comfort

Code	Description	UOM	Price
P33331	Xuron 450S (Tweezer Nose) Serrated	EACH	£8.45



**WORLDWIDE DELIVERY**

**Araldite Rapid Adhesive**

**See Page 1150**



**Xuron 485 (Snipe Nose) Smooth**



- Designed to provide the power grip and hold without the bulk or lack of "feel" found in traditional fine nose pliers
- The Light Touch™ spring returns the pliers to its open position after each use while exclusive Xuron-Rubber™ cushion grips ensure operator comfort

Code	Description	UOM	Price
P33227	Xuron 485 (Snipe Nose) Smooth	EACH	£7.25

**Xuron 485FN (Flat Nose) Smooth**



- A true production fine nose pliers is what we had in mind when we designed the 485FN
- Engineers and production managers told Xuron that traditional forged designs were too bulky and lacked the sensitive feel required for precision electronic assembly
- The 485 performs where the competition failed
- The 485 features a thin profile for access in high density areas, ergonomically shaped, non-slip Xuron-Rubber™ grips, a glare eliminating black finish and light weight for operator comfort

Code	Description	UOM	Price
P33229	Xuron 485FN (Flat Nose) Smooth	EACH	£8.75

**Xuron 485S (Snipe Nose) Serrated**



- Designed to provide the strength to grip and hold

without the bulk or lack of "feel" found in traditional fine nose pliers

- The Light Touch™ spring returns the pliers to its open position after each use while exclusive Xuron-Rubber™ cushion grips ensure operator comfort

Code	Description	UOM	Price
P33225	Xuron 485S (Snipe Nose) Serrated	EACH	£7.65

**Xuron 487 (Chisel Nose) Smooth**



- Designed with the chainmaille artist in mind
- Medium length, flat blades are strong and provide excellent control
- 45° angled tips allow more surface area of the pliers on the ring for better grip and eliminates interference of the pliers tips with the open working space of the jump ring
- 5 inch (127 mm) overall tool length fits comfortably in most hands
- Non-slip, soft rubber hand grips and gentle return spring provide comfort and reduce hand fatigue

Code	Description	UOM	Price
P46124	Xuron 487 (Chisel Nose) Smooth	EACH	£9.95

**Xuron 488 (Round Nose) Smooth**



- Traditional jeweller's pliers designed for a non-traditional approach
- Innovative round tip transitions to elliptical shape along the length of the blades for maximum dexterity and forming possibilities
- Comprising exceptional tip strength this tool is Ideal for forming or looping very fine wire in precision work
- Xuron-Rubber™ cushion grips and Light Touch™ return spring maximizes operator comfort

Code	Description	UOM	Price
P33226	Xuron 488 (Round Nose) Smooth	EACH	£8.75

**www.**

**Online Discounts**

**Xuron 496 (Split Ring & Chain Link)**



Xuron 496

- Finally, split ring pliers that actually work!
- Jump ring closing
- Curved catch tip opens ring then securely grasps it, simplifying installation
- Ergonomic design, non-slip Xuron-Rubber™ grips and light weight make it easy to use
- Will close 20mm to 0.5 mm spit rings

Code	Description	UOM	Price
P33332	Xuron 496 (Split Ring & Chain Link)	EACH	£7.05

- The Ring Punch Brass Block (code D20075) is an excellent complimentary tool to use with a bent punch when punching inside rings, please see below for more details.

Please note precious metal punches are NOT a British Assay Office Hallmark and are sold for your personal identification usage only. See the Precious Metal Information on UK Hallmarks link below and contact your local Assay Office to obtain further information on the Hall Marking Act.

**Alphabetical Sets**



CousinsUK's sets of alphabet punches are exceptional value. They are made from high quality carbon steel for durability and have tempered ends to prevent them chipping while hammering your work.

- Great for I.D tags
- Create personalised inscriptions

Code	Description	UOM	Price
S34115	1mm Height (A to Z plus "/" )	PACK*27	£44.95
P35511	1.5mm Height (A to Z plus "&" )	PACK*27	£9.95
P20864	2mm Height (A to Z plus "&" )	PACK*27	£8.95
P35034	2.5mm Height (A to Z plus "&" )	PACK*27	£5.95

**Alphabetical & Numerical Sets**



CousinsUK's sets of alphabetical and numerical punches are exceptional value. They are made from high quality carbon steel for durability and have tempered ends to prevent them chipping while hammering your work.

- A full set of punches, catering for any message/password/serial number you could want
- Includes the symbol "&"

Code	Description	UOM	Price
P35513	1.5mm Height (A to Z plus "&" and 0 to 9)	PACK*36	£15.95
P35036	2.5mm Height (A to Z plus "&" and 0 to 9)	PACK*36	£6.95

**Adjustable Ingot Moulds**

See Page 1006



**Carat ("k"), Inside Ring, Indian**



- Inexpensive precious metal marking punches
- Swan neck perfect for inside ring marking
- Height of letters 1mm
- International symbol for carat "K"
- Text in "xxxx" is the punch mark
- Made in India

Code	Description	UOM	Price
P38418	"9K" Inside Ring Punch	EACH	£3.50
P35027	"10k" Inside Ring Punch	EACH	£3.50
P35028	"12k" Inside Ring Punch	EACH	£3.50
P35029	"14k" Inside Ring Punch	EACH	£3.50
P35030	"18k" Inside Ring Punch	EACH	£3.50
P35031	"20k" Inside Ring Punch	EACH	£3.50
P35032	"925" (Sterling) Inside Ring Punch	EACH	£3.50
P35033	"950" (Platinum) Inside Ring Punch	EACH	£3.50

**Carat ("ct"), Inside Ring, Indian**



- Inexpensive precious metal marking punches
- Swan neck perfect for inside ring marking
- Height of letters 1mm
- UK symbol for carat "ct"
- Text in "xxxx" is the punch mark
- Made in India

Code	Description	UOM	Price
P36231	"9ct" Inside Ring Punch	EACH	£3.50
P36232	"14ct" Inside Ring Punch	EACH	£3.50
P36233	"18ct" Inside Ring Punch	EACH	£3.50
P36234	"22ct" Inside Ring Punch	EACH	£3.50
P36235	"375" (9ct) Inside Ring Punch	EACH	£3.50
P36236	"750" (18ct) Inside Ring Punch	EACH	£3.50
P36237	"916" (22ct) Inside Ring Punch	EACH	£3.50
P36238	"PLAT" (Platinum) Inside Ring Punch	EACH	£3.50
P36243	"Platinum" Inside Ring Punch	EACH	£3.50
P36239	"Silver" Inside Ring Punch	EACH	£3.50
P36240	"Ster" Inside Ring Punch	EACH	£3.50
P36241	"Sterling" Inside Ring Punch	EACH	£3.50
P36242	"Stg" Inside Ring Punch	EACH	£3.50

**Dog Tag Pendants**

See Page 39



**Bradbury's Hallmarking Guide**

See Page 1379



**PUNCHES: CARAT, ALPHABETICAL, NUMERICAL, SHAPES & SIGNS**

Standard hand punches are the cheapest variation to manually mark letters and numbers for differentiation on metal, plastic, leather and other materials. At its simplest, the mark can be applied to jewellery, ornaments, gifts and components by striking the punch with a hammer.

Our steel stamps are made of high quality, hardened tool steel and are hardened under exact conditions (in comparison to equivalent punches on the market); leading to long durability, optimum productivity and an unbeatable cost versus performance ratio. Hand punches are available in sets of A-Z letters, 0-9 numbers and precious metal identification marks, such as 925.

- For security purposes mark names and numbers on your tools and equipment.
- Mark names, places and events on jewellery designs with the letter and number punches.
- All punches mark items in the traditional 'block style' which is most commonly used for hallmarked jewellery associated products.
- Precious metal punches are available in two styles the 'Straight' for flat pieces and 'Bent' (Swan Neck) for inside rings.
- The size of a single letter or number in relation to hall mark punches are 1mm x 1mm so for example a punch saying STERLING will range from 8mm x 1mm approx.
- Each precious metal punch has an engraved marking on the body to identify punches easily.
- Use a rubber dapping block (code D31265) to rest your items when marking flat or shaped items. As the punch is struck the rubber dapping block will absorb the impact ensuring the stamped piece remains unmarked.



**Carat ("ct"), Inside Ring, Made in USA**



- Hardened tool steel
- High quality
- Long life
- Height of letters 1.5mm
- Text in "xxxx" is the punch mark
- UK symbol for carat "ct"
- Made in USA

Code	Description	UOM	Price
PHB9C	*9ct* Inside Ring Punch	EACH	£18.95
PHB14	*14ct* Inside Ring Punch	EACH	£18.95
PHB18	*18ct* Inside Ring Punch	EACH	£18.95
PHB22	*22ct* Inside Ring Punch	EACH	£18.95
PHB375	*375" (9ct) Inside Ring Punch	EACH	£18.95
PHB750	*750" (18ct) Inside Ring Punch	EACH	£18.95
PHB916	*916" (22ct) Inside Ring Punch	EACH	£18.95
PHB925	*925" (Sterling) Inside Ring Punch	EACH	£18.95
PHB950	*950" (Platinum) Inside Ring Punch	EACH	£18.95
PHBPLAT	*PLAT* (Platinum) Inside Ring Punch	EACH	£18.95
PHBSTER	*Sterling* Inside Ring Punch	EACH	£18.95

**Carat ("ct"), Straight, Made in USA**



- Hardened tool steel
- High quality
- Long life
- Height of letters 1.5mm
- UK Symbol for carat "ct"
- Text in "xxxx" is the punch mark
- Made in USA

Code	Description	UOM	Price
PHS9C	9ct Straight Punch	EACH	£18.50
PHS14	*14ct* Straight Punch	EACH	£18.50
PHS18	*18ct* Straight Punch	EACH	£18.50
PHS22	*22ct* Straight Punch	EACH	£18.50
PHS750	*750" (18ct) Straight Punch	EACH	£18.50
PHS916	*916" (22ct) Straight Punch	EACH	£18.50
PHS925	*925" (Sterling) Straight Punch	EACH	£18.95
PHS950	*950" (Platinum) Straight Punch	EACH	£18.50
PHSPLAT	*PLAT* (Platinum) Straight Punch	EACH	£18.50
PHSSTER	*Sterling* Straight Punch	EACH	£18.50

**PRICE PROMISE GUARANTEE**

**Adjustable Ingot Moulds**

**See Page 1006**



**Decorative Shaped Punches**



**Decorative Punches**

- Precision machine manufactured
- Stainless steel punches
- Set of 18 punches
- Supplied with wooden stand with shape markings
- See photos for included designs

Code	Description	UOM	Price
P47025	Decorative Stamps on Wooden Stand	EACH	£69.95

**Numerical Sets**



CousinsUK's sets of numerical punches are exceptional value. They are made from high quality carbon steel for durability and have tempered ends to prevent them chipping while hammering your work.

- Can etch security codes firmly in metal
- Same for pin numbers
- Keep track of certain items using punched serial numbers

Code	Description	UOM	Price
S34116	1mm Height (0 to 9)	PACK*10	£16.95
P35509	1.5mm Height (0 to 9)	PACK*9	£3.95
P20865	2mm Height (0 to 9)	PACK*9	£6.50
P35035	3mm Height (0 to 9)	PACK*9	£3.95

**Punch Block**



The Ring Punch Brass Block is highly useful for punching inside of rings.

Often holding a ring on a flat surface is an awkward process; for example, the ring could move whilst hitting giving a distorted stamp.

The only way to remove this is to polish it out wasting valuable precious metal. Consisting of a total of fifteen cut shaped grooves covering a range of ring shapes, simply rest the ring in the appropriate sized crevice and

hammer the punch to mark, giving a clean and easily achieved mark.

- Size: 75mm x 30mm x 16mm
- 15 shapes and diameters

Code	Description	UOM	Price
D20075	Ring Punch Brass Block	EACH	£13.95

**Stamping Plier & Punches**



- Easily stamp your precious metal with little effort and maximum convenience
- Specifically designed for easy marking on small rings
- Supplied with 8 punches: "925" x 2, "10ct", "14ct", "18ct", "10K", "14K" & "18K"
- Stamp letter height 3mm
- Easily stamp large amounts of precious metal
- Stainless steel

Code	Description	UOM	Price
P47024	Punch Stamping Plier & Punches	EACH	£30.95

**Dapping Punches, Steel, Zodiac**



**Zodiac Punches**

- Indentation is the zodiac symbol pictured
- Precision machine manufactured
- Stainless steel punches
- Set of 12 punches

**Signs included:**

- Aries
- Taurus
- Gemini
- Cancer
- Leo
- Virgo
- Libra
- Scorpio
- Sagittarius
- Capricorn
- Aquarius
- Pisces

Code	Description	UOM	Price
P47023	Zodiac Punches, Steel	EACH	£74.95

# RING (GEM & WEDDING) TOOLS

## RING CUTTING TOOLS



Even though cutting a ring off is not a jewellery repair, sometimes it falls to a retailer, gold buyer, goldsmith to cut away a ring that can no longer be taken off a finger. This most often happens because an injury or illness has caused the hand to swell, but it might be a matter of simply "growing attached" to your jewellery.

The solution is to use a ring cutter made for this purpose. In our range we have various types of Ring Cutters, in principle they all do the same process but differ in their usage and budget. Remember we supply spare blades which is handy to have because as in time they can wear out. Depending on the metal being cut and thickness a blade can wear quicker if it is cutting a platinum ring rather than a 22ct one.

A general guide on how to use...

Ring cutter pliers work on a leverage and circular saw rotating system. On the top side a circular saw is fitted on a key which rotates forwards and backwards by turning by hand and revolving. The opposite side notice a "V" machined end with a fine centre groove.

Place the customer's hand flat on a table and push the "V" groove under the ring (in between the skin and the inside of the ring) this will protect the finger while cutting. Close your ring cutter applying slight pressure on the blade connecting with the outside of the ring shank and rotate clockwise. The circular saw will start to cut the ring from the outside of the shank.

Applying some bees wax on the blade before and while cutting will prolong blade life and give a smoother cut. Try not to go so fast and press too hard just let the blade teeth smoothly do the work.

As the ring is now cut through use two pairs of bent nose/snipe nose pliers to pull ring apart removing it from the finger.

**WORLDWIDE DELIVERY**

### Ring Cutter, Cousins



Thumb pressure ring cutter

- Light weight easy to handle steel construction
- Unit comes with 2 blades
- Blade size Ø20mm
- Gold/silver ring cutting recommended
- Fantastic value
- Overall Length 160mm
- Weight: 85grams

Code	Description	UOM	Price
R31946	Emergency Ring Cutting Tool	EACH	£17.50
R31947	Emergency Ring Cutting Tool Spare Blade	EACH	£5.50

### Ring Cutter (Compact), A\*F Swiss



A\*F Swiss 18114 - In nickel steel, well finished. Hardened steel sawblade

- One of the world's favourite standard ring cutters
- Gold silver platinum cutting recommended
- Supplied with ring cutter opening key and blade
- Blade size Ø20mm
- Made in Steel
- Size: length 120mm
- Weight: 85grams
- Supplied with blade (R4867)

Code	Description	UOM	Price
R4866	Ring Cutting Tool, A*F 18114	EACH	£31.95
R4867	Ring Cutter Spare Blade, A*F 18114A	EACH	£11.65
R19998	Ring Cutter Key, A*F 18114B	EACH	£3.50
R19999	Ring Cutter Black Locking Nut, A*F 18114C	EACH	£3.20
R20000	Ring Cutter Handle, A*F 18114E	EACH	£4.65

### Diamond Testers

See Page 669



### Diamond & Gemstone Weighing Scales

See Page 729



### Ring Cutter (Large), Cousins Swiss Style

COUSINSUK



Cousins Swiss Style

Large model in polished forged steel. Sturdy construction.

- Blade size Ø30mm x hole 3.5mm
- Length 165mm
- Weight: 165g
- Replacement blades available

Code	Description	UOM	Price
P47133	Ring Cutter (Large), Cousins Swiss Style	EACH	£29.95
P47134	Replacement Ring Cutter Blade	EACH	£17.95

### Ring Cutter, Bergeon 30410-99



Bergeon Swiss 30410.99

We consider this to be the world's best ring cutter

- Excellent for a busy retail shop, handling busy work loads with confidence
- Light weight made in aluminium
- Strong and improved
- Supplied with blade (R15254) HSS
- Gold, silver & platinum cutting recommended
- Spring loaded with adjustable depth adjusting fixing screw
- Size: length 160mm
- Weight: 190grams

Code	Description	UOM	Price
R15253	Ring Cutting Tool, Bergeon 30410-99	EACH	£192.50
R15254	Ring Cutter Blade, Bergeon 30410-99-S-AR	EACH	£33.50
R6514	Ring Cutting Tool Key, Bergeon 30410-C-99	EACH	£16.50



**TRADE SUPPLIER**

### Eye Loupes

See Page 846



## RING MEASURING BOX SETS

Ring sizes are measured in different ways throughout the world and below you will find a large range that caters for all your customers needs. Available with half sizes, traditional "D" shaped rings or comfort "court" shaped rings, nowhere has a more extensive range available.

- UK system: A to Z plus 6
- US system: 1 to 15
- ISO (used in France & Germany): 41 to 76 (matches the inner circumference of the ring in millimetres)

### Gem Ring Set, Including Half Sizes



Gem Ring Gauge Box Set - Including Half Sizes

- Sizes A½ to Z½ + 6
- All half sizes included
- 63 Individual rings
- 4mm wide bands
- Includes stainless steel ring stick with wooden handle: A to Z + 6
- Hinged wooden look box with magnetic closers

Code	Description	UOM	Price
R37996	A½ to Z½ + 6 & Stick, Box Set	EACH	£29.95

### Gem Ring Set, Including UK, US, ISO & Diameter Sizes



Gem Ring Gauge Box Set - Including US, ISO & Diameter Sizes

- Sizes H to Z + 6
- 25 Individual rings
- 4mm wide bands
- Includes stainless steel ring stick with metal handle and 4 gauges
- Hinged wooden look box with magnetic closers

Ring stick gauges:

- UK: A to Z + 6
- USL 1 to 15
- ISO (Circumference in mm): 40 to 78
- Diameter: Ø12 to 24mm

Code	Description	UOM	Price
R8801	H to Z + 6 & Stick, Box Set	EACH	£24.95

### Wedding Ring Set, Including Half Sizes



Wedding Ring Gauge Box Set - Including Half Sizes - "D" Shaped Comfort Profile

- Sizes D to Z½ + 6
- All half sizes included
- 57 Individual rings
- 5mm wide bands
- "Court" shaped profile rings for extra comfort
- Includes aluminium ring stick with aluminium handle: A to Z + 6
- Hinged wooden box
- Made in Europe

Code	Description	UOM	Price
C44288	D to Z½ + 6 & Stick, Box Set	EACH	£49.50

### Wedding Ring Set, Including Half Sizes, Durston



Wedding Ring Gauge Box Set - Including Half Sizes - Durston - "D" Shaped Comfort Profile

- Sizes D to Z½ + 6
- All half sizes included
- 57 Individually polished & ground rings
- "Court" shaped profile rings for extra comfort
- 5mm wide bands
- Includes aluminium ring stick with knurled aluminium handle: A to Z + 6
- Leather case
- Durston 1571
- Made in UK

Code	Description	UOM	Price
R45657	D to Z½ + 6 & Stick, Box Set Durston	EACH	£75.00

### Wedding Ring Set, Including UK, US, ISO & Diameter Sizes



Wedding Ring Gauge Box Set - Including US, ISO & Diameter Sizes

- Sizes H to Z + 6
- 25 Individual rings
- 7mm wide bands
- Traditional "D" shaped rings
- Includes stainless steel ring stick with metal handle and 4 gauges
- Hinged wooden look box with magnetic closers

Ring stick gauges:

- UK: A to Z + 6
- US; 1 to 15
- ISO (Circumference in mm): 40 to 78
- Diameter: Ø12 to 24mm

Code	Description	UOM	Price
R8802	H to Z + 6, & Stick Box Set	EACH	£24.95

### Wedding Ring Set, Superior Quality



Wedding Ring Gauge Box Set - Superior Quality

- Sizes H to Z + 6
- 25 Individual rings
- 7mm wide bands
- Traditional "D" shaped rings
- Includes stainless steel ring stick with rubber coated handle: H to Z + 6
- Elegant black wooden box with magnetic closers
- With conversion chart in the lid, giving the diameter and circumference of each size in mm and inches

Code	Description	UOM	Price
R45627	H to Z + 6 Box Set	EACH	£39.95

## RING MEASURING (FINGER) GAUGES

We supply a large range of ring gauges from various manufactures all of which are made with the very best quality metal alloys. Also take a look at Elma's world famous electronic finger sizing unit the Elma ring meter, which is a fast, accurate and impressive way of sizing in a retail environment.

Gem ring gauge or wedding ring gauge?

It is important have both a wedding ring and a gem ring gauge available in your workshop or showroom. Gem ring gauges are used to measure popular ring styles and are thinner whereas wedding ring bands are wider and provide a more realistic feel of a wedding ring as opposed to a standard ring.

Additionally wedding rings in particular can come in all different shapes and sizes, including the traditional fit "D" shape band (incorporating an inside flat surface as well as the "D" shaped outside surface).

Some hints and tips measuring customers to get the accurate finger size:

- When measuring a customer's finger size, always push the ring gauge (allowing some resistance) over the knuckle and onto the

metacarpals (the part of the finger after the knuckle).

- The fingers on the hand can shrink or expand in different weathers up to one size either way. It is always best to measure finger sizes at room temperature.

Please see PDF link below to view international finger sizing chart for cross referencing sizes

For a history of the manufacturer Wheatshaf, please see our ring measuring sticks section

**Gem Ring Gauges**

Finger Measuring & Sizing - Gem Rings

A wide selection of finger sizing & measurement gauges available in many styles. Whether you're measuring in your busy retail shop, making travelling sales or sending items mail order, we definitely have a gauge suitable for you and to tackle your customer finger sizing.

- Our finger gauges are available in all world sizes
- Steel construction, chrome plated and plastic type
- As an added bonus and helpful tool, use our conversion charts (available as "documents available to download" just above) to assist accurate measurement for your jewellery ring maker

**A to Z, Fan Type - UK**



- A to Z Sizes
- Metal
- Pocket Size

Code	Description	UOM	Price
G4246	A to Z, Fan Type - UK	EACH	£11.28

**A to Z, Wheatshaf**

- Wheatshaf
- A to Z Sizes
- 3.5mm wide rings
- Traditional arrangement of individual graded rings on a circular band



Code	Description	UOM	Price
R1451	A to Z, Wheatshaf	EACH	£24.45

**A to Z, Wheatshaf (Including Half Sizes)**

- Wheatshaf
- A½ to Z½ Sizes
- Traditional arrangement of individual graded rings on a circular band
- Includes half sizes



Code	Description	UOM	Price
R1453	A to Z, Wheatshaf (Including Half Sizes)	EACH	£41.95

**A to Z + 6, Plastic**

- Gem Ring Sizes A-Z+6
- Plastic
- Doesn't matter if lost
- Or even give them away!
- 3mm wide rings
- Made in India



Code	Description	UOM	Price
G34950	A to Z + 6, Plastic	EACH	£2.95

**A to Z + 6 (Including Half Sizes)**

- Gem Ring Sizes A-Z+6
- Well made and accurately finished
- 3mm wide rings
- All metal
- Includes half sizes



Code	Description	UOM	Price
R9219	A to Z + 6 (Including Half Sizes)	EACH	£16.90

**A to Z + 6, Wheatshaf**

- Wheatshaf
- A to Z + 6 Sizes
- 3mm wide rings
- Traditional arrangement of individual graded rings on a circular band



Code	Description	UOM	Price
R1452	A to Z + 6, Wheatshaf	EACH	£39.95

**A to Z + 6, Wheatshaf (Including Half Sizes)**

- Wheatshaf
- A½ to Z½ + 6 Sizes
- 3.5mm wide rings
- Traditional arrangement of individual graded rings on a circular band
- Includes half sizes



Code	Description	UOM	Price
R1454	A to Z + 6, Wheatshaf (Including Half Sizes)	EACH	£42.95

**J To Y, Fan Type**

- J to Y Sizes - 2 holes each size
- Plastic
- Pocket size
- Easy to store and transport



Code	Description	UOM	Price
G39463	J To Y, Fan Type	EACH	£0.95

**Diamond & Gemstone Tweezers**



See Page 1041

**1 to 6 only, Wheatshaf**

- Wheatshaf
- 1 to 6 Sizes
- 3mm wide rings
- Traditional arrangement of individual graded rings on a circular band



Code	Description	UOM	Price
R1457A	1 to 6 only, Wheatshaf	EACH	£8.95

**1 to 15 (US), Wheatshaf (Including Half Sizes)**

- Wheatshaf
- 1 to 15 US Sizes
- 2.5mm wide rings
- Traditional arrangement of individual graded rings on a circular band



Code	Description	UOM	Price
R4250	1 to 15 (US), Wheatshaf (Including Half Sizes)	EACH	£35.95

**Wedding Ring Gauges**

Finger Measuring & Sizing - Wedding Rings

A wide selection of finger sizing & measurement gauges available in many styles. Whether you're measuring in your busy retail shop, making travelling sales or sending items mail order, we definitely have a gauge suitable for you and to tackle your customer finger sizing.

- Our finger gauges are available in all world sizes
- Rounded wedding-style gauges ensure a comfortable, accurate fit. Sizes up to H to Z + 6 are clearly stamped on gauges
- As an added bonus and helpful tool, use our conversion charts (available as "documents available to download" just above) to assist accurate measurement for your jewellery ring maker
- Steel construction & chrome plated

**H to Z + 6**

- British H to Z + 6
- 7mm wide rings
- Well made and accurately finished. All metal.



Code	Description	UOM	Price
R20872	H to Z + 6	EACH	£13.50

**H to Z, Wheatshaf**

- Wheatshaf
- H to Z Sizes
- 7mm wide rings
- Traditional arrangement of individual graded rings on a circular band



Code	Description	UOM	Price
R1455	H to Z, Wheatshaf	EACH	£38.95

**H to Z + 6, Wheatsheaf**

- Wheatsheaf
- H to Z + 6 Sizes
- 7mm wide rings
- Traditional arrangement of individual graded rings on a circular band



Code	Description	UOM	Price
R1456	H to Z + 6, Wheatsheaf	EACH	£46.95

**1 to 6 only, Wheatsheaf**

- Wheatsheaf
- 1 to 6 Sizes
- 7mm wide rings
- Traditional arrangement of individual graded rings on a circular band



Code	Description	UOM	Price
R1457	1 to 6 only, Wheatsheaf	EACH	£11.50

**Electronic Ring Gauge**



Ring Meter from Elma - Finger Measuring & Sizing - Wedding & Gem Rings

The first electronic finger ring gauge of its kind and carrying the Elma name of quality. Covers all the 6 popular modes of:

- UK = C to Z + 11
- European standard, Dia mm, France, USA and Japan. Comfortable and light one handed use with LCD panel data display to confirm exact ring size in one operation and inspire confidence during ring sales and resizing etc.

No motors to malfunction or false read, battery operated with auto shut-off and 2 year guarantee.

Code	Description	UOM	Price
R9738	Ring Meter Elma "Worlds First"	EACH	£129.95

**Multi-Sizer Ring Gauges**

Disposable - Finger Measuring & Sizing - Gem & Wedding Rings

- Supplied in 10 packs
- This accurate and easy to use finger gauge acts like a miniature belt.
- Just 'click' the pliable ribbon to a comfortable size, in or out
- Take a reading and undo it and slide off the finger for re-use.
- Brilliantly simple.
- Advertise your company by stamping your name and address on the back of the packet

**Euro (40 to 76) Multisizer**



- Size 40 to 76
- Supplied in 10 packs
- With bubble magnifier making it easy to read size
- This accurate and easy finger gauge acts like a miniature belt
- Just click the comfortable ribbon size in or out
- Take a reading and undo it and slide off the finger for re-use
- Brilliantly simple
- Advertise your company by stamping your name on the back of the packet

Code	Description	UOM	Price
R32993	Euro (40 to 76) Multisizer	PACK*10	£2.75

**UK (A to Z) Multisizer**

- Size A to Z
- Supplied in 10 packs
- This accurate and easy finger gauge acts like a miniature belt
- Just click the comfortable ribbon size in or out
- Take a reading and undo it and slide off the finger for re-use
- Brilliantly simple
- Advertise your company by stamping your name on the back of the packet

Code	Description	UOM	Price
R7823	UK (A to Z) Multisizer	PACK*10	£1.75

**USA (1 to 17) Multisizer**



- Size 1 to 17 plus Half Sizes
- Supplied in 10 packs
- This accurate and easy finger gauge acts like a miniature belt
- Just click the comfortable ribbon size in or out
- Take a reading and undo it and slide off the finger for re-use
- Brilliantly simple
- Advertise your company by stamping your name on the back of the packet

Code	Description	UOM	Price
R32994	USA (1 to 17) Multisizer	PACK*10	£2.10

**RING MEASURING STICKS**

Ring sizes are measured in different ways throughout the world and below you will find a large range that caters for all your customers needs. Available in various metals & finishes, nowhere has a larger choice available.

- UK system: A to Z plus 6
- US system: 1 to 15
- ISO (used in France & Germany): 41 to 76 (matches the inner circumference of the ring in millimetres)
- Euro/Continental (used in Italy & Spain): 1 to 36

Different materials of ring stick are suitable for different environments, and Cousins covers the lot. For example stainless steel ring sticks are popular in manufacturing and wholesaling where the ring stick is in constant use and needs to be hard wearing. However in a retail environment a lightweight and customer & staff friendly aluminium stick is more suitable and can be moved around a show room more easily (as well as being more aesthetically pleasing. The more traditional user can also choose from zinc or nickel.

*A history of Wheatsheaf*  
In the early 1900's jewellers were experiencing difficulties and delays due to the sizing of rings as rapid growth penetrated the jewellery industry.

In 1920, Joseph Pepper of 3 Vyse Street Birmingham saw the need to develop a sizing standard in the manufacture of rings. The Trademark Wheatsheaf was pioneered here in this year to maintain an accurate and consistent scale of measurement to the entire trade. The Wheatsheaf scale of measurement became the industry standard across the UK to for the production of rings and their sizes.

In 1992 Wheatsheaf saw a need to expand its tool range to include ISO, USA and European standards. This enabled jewellers to have complete confidence to compete in the ever growing international market.

To this day all Wheatsheaf jewellery making tools are made to the same high standard and are checked by hand to maintain the uppermost accuracy, which ranges from a national to an international scale. All Wheatsheaf Jewellery Making tools have always carried the Wheatsheaf logo to identify that they are the one and only original Wheatsheaf product.

Please see PDF link below to view international finger sizing chart for cross referencing sizes

**Aluminium Ring Sticks**



- Aluminium
- Durston, Wheatsheaf or unbranded



See additional information for full specification

Code	Description	UOM	Price
R4202	A to Z, Wheatsheaf	EACH	£31.95
R35289	A to Z + 6	EACH	£9.95
T45660	A to Z + 6, Durston	EACH	£34.95
R7825	A to Z + 6, Wheatsheaf	EACH	£32.95
R7651	Multi Gauged (UK, US, ISO & Euro), Bergeon Swiss	EACH	£46.50
R31920	Multi Gauged (UK, US, ISO & Diameter), Indian	EACH	£9.95

Price breaks available, see website

**Nickel Ring Sticks**



- Nickel
- Wheatsheaf or unbranded

See additional information for full specification

Code	Description	UOM	Price
R31919	A to Z + 6 (UK)	EACH	£20.25
R4209	A to Z + 6 (UK) Wheatsheaf	EACH	£39.95
R4206	Multi Gauged (UK & ISO) Wheatsheaf	EACH	£35.95
R4207	Multi Gauged (Euro & ISO) Wheatsheaf	EACH	£41.40

**Stainless Steel Ring Sticks**



- Stainless steel
- With wooden handle
- Wheatsheaf or unbranded

See additional information for full specification

Code	Description	UOM	Price
R4208	A to Z (UK) Wheatsheaf	EACH	£49.95
R1449	A to Z + 6 (UK) Wheatsheaf	EACH	£53.50
R19783	Multi Gauged (UK, US, ISO, Euro & Diameter)	EACH	£19.95

**Zinc Ring Sticks**



- Zinc
- Wheatsheaf

See additional information for full specification

Code	Description	UOM	Price
R4203	A to Z (UK), Wheatsheaf	EACH	£22.50
R1450	A to Z + 6 (UK), Wheatsheaf	EACH	£32.95
R4211	Multi Gauged (ISO & Euro), Wheatsheaf	EACH	£31.65

**RING STRETCHERS, REDUCERS & BENDERS**

Ring adjusting tools are available in different types to suit your budget needs.

- Swiss, Italian, UK or Indian manufactured tools
- Our Italian, Swiss & UK ring sizing tools are of a very high quality and are very well suited for the manufacturer coping with constant work loads
- Our range of Indian ring sizing tools are a good economy price, made with quality and excellent value in mind, suited for the retail/ smaller quantity work

Some useful hints and tips when stretching/ reducing:

One must appreciate there is a number of sizes a ring can be stretched. Some particulars to remember is the type of metal, gold, silver, platinum etc (the softer the metal the more it can be stretched as it is less rigid, metals like platinum are far harder to stretch than say 22ct gold), also the method the ring has been constructed. A plain cast wedding band has no solder join therefore a 22ct ring can be stretched up to 1 to 8 sizes.

Having a solder join on a ring creates a weak point so therefore when over stretching is performed it will come apart from the join (the weakest point).

At times, depending on the your experience and the type of ring, you may have to add metal to enlarge the ring size. Therefore a stretching tool may not be appropriate (we have a large selection of tools and equipment catering for this process see below).

To spot a solder join, heat the ring to near a cherry red colour then place in water you will notice a colour change line (this is where it has been soldered). Heating a ring up does soften it & so helps the ring stretch process to be perform easier.

With gem set rings there is more risk of either damaging the stones or the setting while heating or stretching. To protect gem stones while heating it is a good to cover the stones with cool heat to protect them (see link below).

The upright ring stretcher is suited to plain bands, any attempted to stretch gem set rings runs the risk of them falling out, also on the reducer plate gemstones can get damaged.

The most suited tool for stretching gem set rings is the (roller type) gemstone ring stretcher (see below for models and info).

Remember any type of stretching done using these tools may leave some after marks so finishing is required (see links below).

**Gem Ring Stretcher, Indian**



Gem ring stretcher ideal for a jewellery retail shop.

The idea of this tool is that it will compress the metal of your ring shank for gemstone rings thus expanding the size of the ring.

How to use...

1. The base has to firstly be secured to your work surface by screwing it down with long screws or nuts and bolts on to a work surface (not supplied).
2. The unit has a selection of half round and "V" shaped dies.
3. Depending on the shape, size and thickness of the shank you want to stretch. Choose a die that fits in with little movement against the rig shank.
4. To fit this die into the unit, pull out the holding pin on the top of the stretcher. You will find the die and gear nearest to the open/closing handle can be removed.
5. Place your selected die on top of the gear and fit back into the stretcher locking it with the holding pin.
6. Place the ring between the two rollers and turn handle clockwise. The rollers will start meeting both sides of the ring. Once both rollers are touching the ring shank securely hold handle and move left to right 45°.
7. Perform in smooth actions about 3 to 4 times.
8. Take the ring off and measure size, if still too small repeat the process with another dies that fits.
9. The more you turn handle to close die and tighten on the ring and swing left to right determines how much the ring shank is being compressed. (hence ring size increasing).

Contains:

- 15 dies in a plastic storage box
- Steel construction
- Sizes stretching capacity H to Z + 6
- Overall size 95mm x 195mm x 90mm
- Weight 1400 grams

Code	Description	UOM	Price
R31948	Gem Ring Stretching Tool, Indian Made	EACH	£19.95

**Gem Ring Stretcher, Italian**



High Quality Gem ring stretcher ideal for a jewellery retail shop.

The idea of this tool is that it will compress the metal of your ring shank for gemstone rings thus expanding the size of the ring.

How to use...



**SAME DAY DISPATCH**

**Diamond & Gemstone Tweezers**



See Page 1041

**Diamond Ring Buying Guide**



See Page 1380

1. The base has to firstly be secured to your work surface by screwing it down with long screws or nuts and bolts on to a work surface (not supplied).
2. The unit has a selection of half round and "V" shaped dies.
3. Depending on the shape, size and thickness of the shank you want to stretch. Choose a die that fits in with little movement against the rig shank.
4. To fit this die into the unit, pull out the holding pin on the top of the stretcher. You will find the die and gear nearest to the open/closing handle can be removed.
5. Place your selected die on top of the gear and fit back into the stretcher locking it with the holding pin.
6. Place the ring between the two rollers and turn handle clockwise. The rollers will start meeting both sides of the ring. Once both rollers are touching the ring shank securely hold handle and move left to right 45°.
7. Perform in smooth actions about 3 to 4 times.
8. Take the ring off and measure size, if still too small repeat the process with another dies that fits.
9. The more you turn handle to close die and tighten on the ring and swing left to right determines how much the ring shank is being compressed. (hence ring size increasing).

Contains:

- 16 dies in a plastic storage box
- Steel construction
- Sizes stretching capacity H to Z + 6
- Overall 210mm x 120mm x 125mm
- Weight 2400 grams
- O.M.O Italy

See Website PDF for diagram of replacement parts available

Code	Description	UOM	Price
R5196	Gem Ring Stretching Tool, Italian Made	EACH	£184.95
R20246	Centre Post & Washer (Part A & F)	EACH	£20.95
R47816	Gear Wheel (Spare Part E)	EACH	£8.95

## Ring Bender

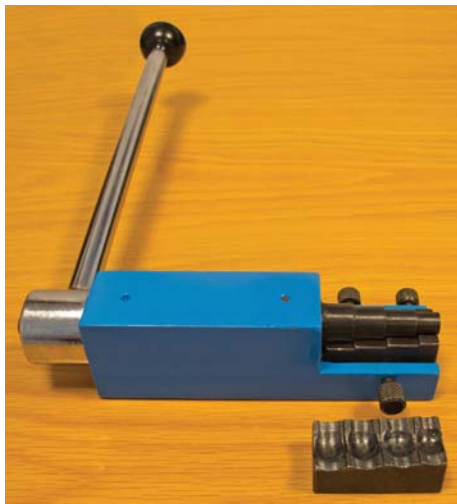

- Ring bender
- Cast iron base
- Will bend flat, oval and half round blanks
- Will bend blanks up to 4mm thick
- Includes 2 ring bending dies & stepped mandrel

Dimensions: 200 x 50 x 50mm, Handle 30cm

Code	Description	UOM	Price
R47019	Ring Bender	EACH	£49.95

### Ring Shank Bender, Durston

See Page 873



## Ring Bender, Durston



Durston Ring Bender - Heavy Duty

Heavy duty cast iron construction with hardened steel shaft will bend up to 4mm thick, includes two precision hardened and ground dies.

- Supplied with 2 polished stainless steel dies
- Comes with additional metal plates allowing thicker/softer material to be bent
- Will bend up to 4mm thick
- Cast iron base
- Durston 1306
- Made in UK
- Weight 9kg

Dimensions: 120 x 190 x 90mm, Handle 25cm

Code	Description	UOM	Price
R47386	Ring Bender, Durston	EACH	£172.50

## Ring Bending Pliers

COUSINSUK



Ring Bending Plier

- Easily shapes sheet metal and wire
- Will easily bend wire and sheet up to 5mm (6 gauge) thick
- Overall length 180mm
- With stop so you can set the amount of curve required
- PVC coated handles
- Superb Swiss quality
- Cousins Swiss Style

Code	Description	UOM	Price
P48595	Ring Bending Plier	EACH	£18.95

## Economy Ring Stretcher

Tapping insert with a hammer expands the mandrel and allows enlargement to 6 sizes.

This is an incomparable and economical way to stretch rings with minimal expense. The ring stretcher comes in three parts, tapered mandrel, stepped opening collet and wooden base.

How to use:

- Place the ring to be stretched on the stepped opening collet



- Push the tapered mandrel into the collet and place on the wooden ring stand
- Now tap with a hammer (code: H19525) the taper will start opening the collet thus stretching the ring
- A good way of controlling the stretch with more accuracy is use a G- clamp (code: C33518)
- Instead of tapping with a hammer, the G clamp on each turn will accurately stretch the ring
- For sizes M to Z + 6

Weight : 320 grams

Code	Description	UOM	Price
R4920	Economy Ring Stretching Tool	EACH	£10.90

## Wedding Ring Stretcher, Bergeon



Bergeon 6830.30 - Swiss Made

Enlarging & Reducing - Patterned & Non Patterned Rings - Bergeon Swiss Made

- High quality outfit for increasing or reducing ring sizes
- Allows the reducing/expanding of wedding rings that are plain, patterned or faceted
- 22 protective nylon dies hold the ring inside the steel chucks, ensuring the outside of the ring is protected whilst reducing
- 4 protection sleeves which sit on the ring expander ensure that the inside of the ring is protected whilst expanding
- Excellent for softer metals
- Heavy cast frame

Item contains:

- Ring stretcher/reducer
- 8 reversible steel chucks, Ø15 to 30mm (1mm jumps). Polished on the inside (R7819)
- 22 nylon protective dies (0.5mm jumps) (R7820)
- 2 reversible nylon die holders
- 4 inner ring protection sleeves (D0421)

Dimensions:

- 90 x 150 x 400mm (W x D x H)
- Lever length 290mm
- 14.5Kg

Code	Description	UOM	Price
R2817	Wedding Ring Stretcher & Reducer, Bergeon	EACH	£995.00
R7819	Die Set (Steel) for Reducing Rings	EACH	£245.00
R7820	Protection Nylon Die Set	EACH	£289.95
D0421	Protection Nylon Sleeves	EACH	£60.95
R7817	Enlarging & Reducing Tool For Non Patterned Wedding Rings	EACH	£415.00

## Polishing Rouge

See Page 1171



**Wedding Ring Stretcher, Durston**



Enlarging & Reducing - Made in Great Britain by Durston

A high quality, British made ring stretcher giving the jeweller and retailer the ability to re-size rings with ease

Features:

- A 6 spline mandrel
- 16 polished and countersunk polished steel dies
- Will reduce bands up to 12mm wide
- High finished reversible reducer plate
- Specially designed gear reduction means effortless forming
- Heavy duty cast iron construction with hardened steel shaft

How to use reducer plate:

The reducer plate is a very handy feature incorporated with this stretcher. The use of the press with plate compress a ring shank to a smaller size. Notice on the reducer plate there is a selection of tapered machine holes to suit different ring shank sizes.

To reduce your wedding band place your ring on the tapered hole so it sits in with it half in and out. Move the reducer plate so it meets the top of the planishing drop die (the circular plate that moves down towards the reduction plate when handle is pulled down). Pull handle down so it pushes the ring into the taper. This is slightly compressing the shank thus making it smaller. Repeat this process moving the ring round to keep the sizing even and regular in space.

Please note: Additional finishing will be required. It is not advisable to reduce patterned wedding bands as they can be easily marked. (see code R2817 for ring stretcher reducer for pattern wedding rings seizer tool from Bergeon Switzerland)

- Made in Great Britain
- Size: 390 x 180 x 120mm
- Weight: 9.5kg
- Durston 1301

Code	Description	UOM	Price
R42923	Wedding Ring Enlarging & Reducing Tool, Durston	EACH	£249.95

**PRICE PROMISE GUARANTEE** ✓

**Emery Sticks - All Shapes**

See Page 1148

**Wedding Ring Stretcher, Durston with Ring Bender**



Enlarging, Reducing & Bending - Made in Great Britain by Durston

A high quality, British made ring stretcher & bender giving the jeweller and retailer the ability to re-size rings with ease. The same as tool R42923 but with additional ring bending capability

Features:

- A 6 spline mandrel
- 16 polished and countersunk polished steel dies
- Will reduce bands up to 12mm wide
- High finished reversible reducer plate
- Will bend rings up to 4mm thick
- Bending and shaping of half round, flat, oval and engraved shank material into circular rings
- Two matching bending hardened and precision ground dies are supplied
- It is effective on hard alloy metals
- Specially designed gear reduction means effortless forming
- Heavy duty cast iron construction with hardened steel shaft

How to use reducer plate:

The reducer plate is a very handy feature incorporated with this stretcher. The use of the press with plate compress a ring shank to a smaller size. Notice on the reducer plate there is a selection of tapered machine holes to suit different ring shank sizes.

To reduce your wedding band place your ring on the tapered hole so it sits in with it half in and out. Move the reducer plate so it meets the top of the planishing drop die (the circular plate that moves down towards the reduction plate when handle is pulled down). Pull handle down so it pushes the ring into the taper. This is slightly compressing the shank thus making it smaller. Repeat this process moving the ring round to keep the sizing even and regular in space.

Please note: Additional finishing will be required. It is not advisable to reduce patterned wedding bands as they can be easily marked. (see code R2817 for ring stretcher reducer for pattern wedding rings seizer tool from Bergeon Switzerland)

- Made in Great Britain
- Size: 390 x 180 x 150mm
- Weight: 10Kg
- Durston 1302

Code	Description	UOM	Price
R45661	Wedding Ring Enlarging, Reducing & Bending Tool, Durston	EACH	£279.95

**IMPROVED SPEED SEARCH**

**Wedding Ring Stretcher, Italian**



Enlarging & Reducing - O.M.O Italy

One of the highest quality and world favourite Ring Stretcher's available in the Jewellery Industry .

Features:

- Sizes H to Z + 3 reducing & enlarging wedding rings
- Durable and robust able to handle workshop sizing with confidence
- Ring stretching mandrel polished with size markings
- High finished revisable reducer plate
- The base has to firstly be secured to your work surface by screwing it down with long screws or nuts and bolts on to a work surface (not supplied).

How to use reducer plate...

The reducer plate is a very handy feature incorporated with this stretcher. The use of the press with plate compress a ring shank to a smaller size. Notice on the reducer plate there is a selection of tapered machine holes to suit different ring shank sizes.

To reduce your wedding band place your ring on the tapered hole so it sits in with it half in and out. Move the reducer plate so it meets the top of the planishing drop die (the circular plate that moves down towards the reduction plate when handle is pulled down). Pull handle down so it pushes the ring into the taper. This is slightly compressing the shank thus making it smaller. Repeat this process moving the ring round to keep the sizing even and regular in space.

Please note: Additional finishing will be required. It is not advisable to reduce patterned wedding bands as they can be easily marked. (see code R2817 for ring stretcher reducer for pattern wedding rings seizer tool from Bergeon Switzerland)

- O.M.O Italy
- Size: 380 x 180 x 130mm
- Weight: 11.5kg

Code	Description	UOM	Price
R5193	Wedding Ring Enlarging & Reducing Tool, Italian Made	EACH	£245.00
R9195	Reducing Wheel Die, Italian Made	EACH	£159.45

**Wedding Ring Stretcher, Indian**

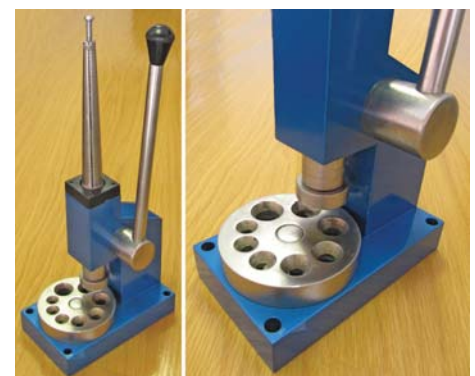

Enlarging & Reducing - Indian Made

A robust economical priced ring stretcher ideal for a small workshop/retail shop



- Sizes H to Z wedding rings from 8 reversible holes
- Ring stretching mandrel finished with size markings
- Finished revisable reducer plate
- The base has to firstly be secured to your work surface by screwing it down with long screws or nuts and bolts on to a work surface (not supplied).

How to use reducer plate:

The reducer plate is a very handy feature incorporated with this stretcher. The use of the press with plate compress a ring shank to a smaller size. Notice on the reducer plate there is a selection of tapered machine holes to suit different ring shank sizes.

To reduce your wedding band place your ring on the tapered hole so it sits in with it half in and out. Move the reducer plate so it meets the top of the planishing drop die (the circular plate that moves down towards the reduction plate when handle is pulled down). Pull handle down so it pushes the ring into the taper. This is slightly compressing the shank thus making it smaller. Repeat this process moving the ring round to keep the sizing even and regular in space. When reducing ring sizes they must be reduced in stages. A ring has to gradually reduced, using one reducer hole at a time until the desired size is reached.

Please note: Additional finishing will be required. It is not advisable to reduce patterned wedding bands as they can be easily marked. (see code for ring stretcher reducer for pattern wedding rings seizer tool from Bergeon Switzerland)

- Made in India
- Size: 380 x 180 x 130mm
- Weight: 11.5kg

Code	Description	UOM	Price
R31945	Wedding Ring Enlarging & Reducing Tool, Indian Made	EACH	£69.95

## RING & BRACELET CLAMPS

We have an immense selection of jewellery & component holding tools in stock in various materials.

Often holding jobs with the hands is impractical, whatever job you are doing there is a ring clamp in our range to suit your requirement.

For holding rings, earrings, pendants, broaches, chain, watches, gem stones and fine components.

### Ring Clamp Levers, Wood



Holding a ring to polish inside can be awkward, particularly with smaller sized rings. This tool combats all of these problems with ease assuring you the completing of the job efficiently.

We also supply a large range of inside felts, abrasives and final finish cotton inside cones in a variety of sizes and materials to cater for all inside ring finishing.

Features

- Light weight
- Spring loaded
- 200mm in length and only weighing
- Will hold practically any size, shape and style of ring, wedding, signet, eternity, etc

Weight: 42 grams

Code	Description	UOM	Price
P19731	Ring Holding Wooden Clamp	EACH	£3.15

### Ring Clamp with 9 Dies



This exceptional tool allows you to access the circumference of a ring.

Firmly grips the ring from the inside without marking, allowing work on the outside of the ring.

- Mount the ring with ease, with the cleverly designed knurled hand operated head locking thread and pin. Or lock the ring with an Allen key and hex head nut giving extra holding power.
- Includes nine plastic sleeve inserts from sizes 13mm to 22mm in diameter which cover the standard A to Z British Sizes.
- Smooth hardwood handles for comfortable hand-held operations.
- Unit comes in a quality wooded finished storage box

Weight: 525 grams

Code	Description	UOM	Price
R20127	Internal Holding Ring Clamp with 9 Dies	EACH	£28.50

### Ring Clamp with End Screw



This ring clamp enables you to hold rings internally in order to work on the outer face of the ring easily.

Unwind the wing nut anti-clockwise to loosen the centre metal taper; mount the ring on the opposing end. To secure, turn the wing nut clockwise and the taper will tighten. This expands the four wooden jaws putting pressure inside the ring and hence locking, ready to be worked on.

- Will hold from sizes H to M
- Wooden jaws
- Wing nut winder
- If you require a clamp for larger and smaller sizes take a look at ring holding clamp with 9 dies (Code R20127)
- Overall length 145mm
- Weight: 84 grams

Code	Description	UOM	Price
R4624	Internal Holding Ring Clamp (Wood) with End Screw	EACH	£3.65

### Ring Clamp with End Screw, Leather Jaws



This ring clamp enables you to hold rings internally in order to work on the outer face of the ring easily.

Twist the handle to loosen the centre metal taper; mount the ring on the opposing end. To secure, turn the wing nut clockwise and the taper will tighten. This

expands the four wooden jaws putting pressure inside the ring and hence locking, ready to be worked on.

- Soft leather jaws for extra protection
- Easy handle winder
- Overall length 130mm
- Jaw width 30mm

Code	Description	UOM	Price
R45547	End Locking Clamp with Leather Jaws	EACH	£5.95

### Ring Clamp with End Screw

VALUE



- Thread action grips like a bench vice and allows rapid and accurate positioning of the ring
- Aluminium
- Features lined jaws to prevent damage to the ring
- Comfortable, rubber covered handle
- Easily dismantled for cleaning
- Made in India

Dimensions:

- Height 190mm
- Diameter of rubber covered handle 30mm
- Jaw size: 30mm x 30mm – jaws opening 8mm
- Weight: 400g

Code	Description	UOM	Price
R39564	Ring Clamp, Screw End	EACH	£22.95

### Ring Clamp with End Screw, A\*F Swiss



This A\*F Swiss is our most prestigious ring clamp from our range. Strong and robust, it can handle large volumes of work and is very comfortable to work with; looked after properly can last a life time.

Thread action grips like a bench vice and allows rapid and accurate positioning of the ring. Precision made from steel and aluminium for long life.

Features lined jaws to prevent damage to the ring, comfortable, rubber covered handle and exit hole for filings.

Easily dismantled for cleaning. Includes one pair of replacement jaw inserts.

Size and weight:

- Height 170mm
- Diameter of rubber covered handle 30mm
- Jaw size: 30mm x 25mm – jaws opening 10mm
- Weight: 290g

Code	Description	UOM	Price
R1436	Ring Clamp, A*F Swiss 140.505	EACH	£114.95
R1440	Ring Clamp Insert Jaw, A*F Swiss 140.505.1	EACH	£5.25

### Soldering Ring Stand

See Page 1010



### Ring Clamp with Side Screw, Aluminium



Side Locking Screw - Aluminium - Leather Jaws

- Bergeon 6732
- Side Screw Leather Jawed Aluminium Ring Clamp
- Internal/External hold
- With leather protection
- Clamping screw and release spring
- In aluminium
- Length 135mm
- Weight: 135 grams

Code	Description	UOM	Price
R1441	Side Locking Screw Ring Clamp (Aluminium) with Leather Jaws	EACH	£31.40

### Ring Clamp with Side Screw, Leather Jaws



Side Locking Screw - Wood - Leather Jaws

The side locking screw clamp is a traditional tool which holds jewellery, components but particularly rings.

- Having a side locking wing nut and bolt fitting strengthens the grip on pieces.
- The clamps jaws are lined with leather to prevent marking work.
- Made from wood the clamp is lightweight and the wing nut and bolt is made from steel, making it robust
- Overall length: 135mm
- Weight: 75 grams

Code	Description	UOM	Price
R4226	Side Locking Screw Ring Clamp (Aluminium) with Leather Jaws	EACH	£3.95

### Ring Clamp with Side Screw, Wooden Jaws



Side Locking Screw - Wood - Wood Jaws

The side locking screw clamp is a traditional tool which holds jewellery, components but particularly rings.

- Having a side locking wing nut and bolt fitting strengthens the grip on pieces
- The jaws are wooden allowing the user to adapt and shape the clamp to hold differently shaped pieces.
- Made from wood the clamp is lightweight and the wing nut and bolt is made from steel, making it robust.
- Overall length: 135mm
- Weight: 75g

Code	Description	UOM	Price
R5346	Side Locking Screw Ring Clamp (Wood) with Wood Jaws	EACH	£2.95

### Ring Clamp with Wedge, Plastic



Wedge Ring Clamp - Plastic - Leather Jaws

The wedge clamp is a traditional tool which holds jewellery, components but particularly rings. Also known as speed clamps they make every day repairs, alterations, making fast and easy.

To use: simply pull the wedge out of the clamp, and then place the item in the opposing end. Replace the wedge until tight in the clamp to secure the piece. To secure further, tap the wedge on the bench.

To release the item tap the wedge sideways on your bench until release. Items can be gripped in either ends, one being rounded, and the other flat. The clamps jaws are lined with leather to prevent marking work. The centre pivot band is made from steel giving an extra strong grip.

- Light weight plastic construction
- Opening maximum 15mm
- Both sides have leather coated jaws
- Supplied with plastic wedge
- Made in India
- Overall length: 150mm
- Weight: 100g

Code	Description	UOM	Price
R39563	Wedge Ring Clamp (Plastic) with Leather Jaws	EACH	£3.95

### Ring Clamp with Wedge, Plastic, Bergeon Swiss



Wedge Ring Clamp - Plastic - Leather Jaws

The wedge clamp is a traditional tool which holds jewellery, components but particularly rings. Also known as speed clamps they make every day repairs, alterations, making fast and easy.

To use: simply pull the wedge out of the clamp, and then place the item in the opposing end. Replace the wedge until tight in the clamp to secure the piece. To secure further, tap the wedge on the bench.

To release the item tap the wedge sideways on your bench until release. Items can be gripped in either ends, one being rounded, and the other flat. The clamps jaws are lined with leather to prevent marking work. The centre pivot band is made from steel giving an extra strong grip.

- Light weight plastic construction
- Opening maximum 15mm
- Both sides have leather coated jaws
- Supplied with plastic wedge
- Bergeon Swiss
- Overall length 150mm
- Weight 100g

Code	Description	UOM	Price
R1442	Wedge Ring Clamp (Plastic) with Leather Jaws	EACH	£19.15

### Ring Clamp with Wedge, Wooden



The wedge clamp is a traditional tool which holds jewellery, components but particularly rings. Also known as speed clamps they make every day repairs, alterations, making fast and easy.

To use: simply pull the wedge out of the clamp, and

then place the item in the opposing end. Replace the wedge until tight in the clamp to secure the piece. To secure further, tap the wedge on the bench. To release the item tap the wedge sideways on your bench until release. Items can be gripped in either ends, one being rounded, and the other flat. The clamps jaws are lined with leather to prevent marking work. The centre pivot band is made from steel giving an extra strong grip.

- Light weight wooden with metal hinged centre
- Both sides have leather coated jaws
- Opening maximum 15mm
- Overall length 150mm
- Weight: 45g

Code	Description	UOM	Price
R4227	Wedge Ring Clamp (Wood) with Leather Jaws	EACH	£3.95

### Ring Clamp with Wedge, Wooden Mahogany



Deuxe Mahogany Ring Clamp

- Show off your rings to customers in style
- Look professional and high end
- Prevents oily/dirty fingers from touching the piece

The wedge clamp is a traditional tool which holds jewellery, components but particularly rings. Also known as speed clamps they make every day repairs & alterations fast and easy.

To use: simply pull the wedge out of the clamp, and then place the item in the opposing end. Replace the wedge until tight in the clamp to secure the piece. To secure further, tap the wedge on the bench. To release the item tap the wedge sideways on your bench until release. Items can be gripped in either ends, one being rounded, and the other flat. The clamps jaws are lined with leather to prevent marking work. The centre pivot band is made from steel giving an extra strong grip.

- Light weight wooden with metal hinged centre
- Both sides have leather coated jaws
- Opening maximum 15mm
- Rich Mahogany
- Overall length 150mm
- Weight: 45g

Code	Description	UOM	Price
R47020	Wedge Ring Clamp (Wood, Mahogany) with Leather Jaws	EACH	£4.95

## SANDBAGS & PITCH BOWLS

### Pitch Bowls & Pitch Bowl Bases

A pitch bowl is used to support work and hold it absolutely firm for chasing. A pitch bowl is made of cast iron and rests on a rubber ring pad. We have two sizes available in stock which would cover most sizes of jewellery work.

- Cast iron
- Ø125 & Ø190mm
- Bases also available

To use:

- Fill the bowel with scrap iron or cement, leaving 3cm of room on top. Then top up the last 3cm with pitch mixture
- To make the correct pitch consistency, mix two parts of pitch with one part of plaster of Paris powder and add a thimble-size knob of tallow

Weights:  
 E31907: 1.5Kg  
 E31908: 2.5Kg  
 E31909: 800g  
 E31910: 400g

## Ø125mm (5") Deep Pitch Bowl



- Inner diameter approx Ø100mm (4")
- 60mm deep
- Base required, item code: E31909
- Cast iron

Code	Description	UOM	Price
E31907	Ø125mm (5") Deep Pitch Bowl	EACH	£9.95

## Ø125mm (5") Rubber Pad for Pitch Bowl



- For Pitch Bowl item: E31907
- Overall Diameter Ø130mm
- 27mm Deep
- Inner Step Diameters: 100mm & 80mm

Code	Description	UOM	Price
E31909	Ø125mm (5") Rubber Pad for Pitch Bowl	EACH	£4.95

## Ø190mm (7.5") Deep Pitch Bowl



- Inner diameter approx Ø170mm (6.5")
- 65mm deep
- Base required, item code: E31910
- Cast iron

Code	Description	UOM	Price
E31908	Ø190mm (7.5") Deep Pitch Bowl	EACH	£13.95

## Ø190mm (7.5") Rubber Pad for Pitch Bowl



- For Pitch Bowl item: E31908
- Overall Diameter Ø200mm
- 27mm Deep
- Inner Step Diameters: 140mm & 115mm

Code	Description	UOM	Price
E31910	Ø190mm (7.5") Rubber Pad for Pitch Bowl	EACH	£6.95

## Sandbags, Round



These sandbags conform to the contour of your work piece to provide a base of work surface when forming, chasing, stamping or engraving.

- 2 sizes
- Round
- Leather with heavy stitching
- Excellent Value

Code	Description	UOM	Price
S30558	Ø150mm Sandbag	EACH	£7.95
S30559	Ø200mm Sandbag	EACH	£8.95

## Sandbags, Square

### 150 x 150mm Sandbag



Code	Description	UOM	Price
S39043	150 x 150mm Sandbag	EACH	£6.95

### Forming Tools - Disk Cutters

See Page 888



### Engravers Spherical Revolving Block

See Page 666



# SAWS & PIERCING SAW BLADES

## HACK SAWS

### 150mm Hacksaw



A hacksaw is a fine-tooth hand saw with a blade held under tension in a frame and is used for cutting materials such as metal or plastics.

Top tip: Cutting on the pull stroke increases the blade tension and will result in greater control of the cut and longer blade life.

- 6" (150mm)
- Tension held blade

Code	Description	UOM	Price
H6254	Junior Hacksaw	EACH	£1.95
B6256	Junior Hacksaw Blades	PACK*12	£1.95

### 300mm Hacksaw



- Professional hacksaw
- 300mm (12 inch) blade
- Lightweight yet very rigid frame
- Very accurate cutting
- High leverage tension device
- Replacement blades S45925, 27 & 28
- Made by Roebuck

Code	Description	UOM	Price
S45924	300mm Professional Hacksaw	EACH	£7.95

### Adjustable Hacksaw



- Adjustable hacksaw
- Can take 300 or 250mm (12 or 10 inch) blades
- Spare blades can stored in the tubular handle
- Die cast handle with guarded grip
- Very accurate cutting
- Unique blade tensioning nut
- Replacement blades S45925, 27 & 28
- Made by Roebuck

Code	Description	UOM	Price
S45923	Adjustable Hacksaw	EACH	£8.50

### Hacksaw Blades

Roebuck	BI METAL	12 x 1/2 x 18mm / 300 x 12.8 x 18mm	2521811	← 18mm
Roebuck	BI METAL	12 x 1/2 x 24mm / 300 x 12.8 x 24mm	497096	← 24mm
Roebuck	BI METAL	12 x 1/2 x 32mm / 300 x 12.8 x 32mm	2521813	← 32mm

- Bi-metal hacksaw blades

**WORLDWIDE DELIVERY**

**Online Order Tracking**

- Virtually unbreakable and shatterproof
- 300mm (12 inch)
- 18, 24 or 32 teeth per inch (TPI)
- Made by Roebuck

Code	Description	UOM	Price
S45925	18 TPI, 300mm Hacksaw Blade	EACH	<b>£1.50</b>
S45927	24 TPI, 300mm Hacksaw Blade	EACH	<b>£1.50</b>
S45928	32 TPI, 300mm Hacksaw Blade	EACH	<b>£1.50</b>

## SAWS BLADES & FRAMES (FRET & PIERCING)

A piercing saw is a small tool in a fretsaw styled frame that has fine blades intended for cutting metal, traditionally used by jewellers, but has uses in model making and an array of metalworking fields that requires fine detail. Piercing saws are capable of cutting other materials including wax, wood and plastic, although principally they are mainly used on metal. The piercing saw gets its name from the process of making 'blind' cuts or 'piercings' whereby a small hole is first drilled through the work; one end of the saw blade is fitted into the saw frame and the other is threaded through the hole. The open end of the blade is then clamped into the remaining end of the saw frame. When sawing is completed, the saw blade is unclamped from one end of the frame and withdrawn from the work.

Piercing saws have a frame with pinch clamps that will grip the blades; handles are usually wooden like the examples from our range below.

Our ranges of saw frames are available in throat depths that vary from three to twelve inches.

The saws illustrated in our product range, have sliding adjustment to cope with differing blade lengths; this also enables the user to use the remainder of any broken blades. The sliding action of this feature is also used to tension the blade rather than the more normal method (described below) that is applied to fitted frames.

The saw blade is fitted into the thumbscrew clamps with the teeth facing towards the handle. The blades are fragile and are designed to cut on the pull down stroke so that the blade is held straight by the extra tension caused by the teeth's resistance, guaranteeing no buckling of the blade.

The brown colourisation of the blade is due to its copper plate which inhibits rust and also acts as a minor lubricant when cutting hard steel.

However, the most optimum method of lubrication is to pull the blade from end to end across a block of beeswax, which lubricates the cutting and renders the cutting action quieter and 'sweeter to the feel'.



### A\*F Swiss "Diamond" Saw Blades



A\*F Swiss

Made by electroplating diamond particles on to piano wire, the blade offers the best quality available at competitive prices. A heavy coating of diamond ensures long life and quick cutting.

To make the job easier, we recommend using our cutting lubricant wax (B4181). Blades come individually packaged. Great for cutting glass, ceramics, bone, shell, stones and composite material etc.

- Swiss Made
- Length 135mm
- Grit values 60, 100, 120 & 140

Code	Description	UOM	Price
S47547	60 (Coarse) Diamond Saw Blade (Ø1.30mm)	EACH	<b>£18.50</b>
S47548	100 (Medium - Coarse) Diamond Saw Blade (Ø1.20mm)	EACH	<b>£18.50</b>
S47549	120 (Medium) Diamond Saw Blade (Ø1.10mm)	EACH	<b>£18.50</b>
S47550	140 (Fine) Diamond Saw Blade (Ø1.00mm)	EACH	<b>£18.50</b>

### A\*F Swiss "Gold Shark" Saw Blades



A\*F Swiss - Superior Quality

These come in a wide variety of types, thicknesses and tooth frequency. They are made from hardened and tempered steel and have blank end portions that are intended as clamping areas. Rounded profile of the back, non cutting edge aids the sawing of curved lines and for really tight curves spiral formed blades are available.

Blades are suitable for sawing gold, platinum, palladium, silver, brass, copper and steel, these are manufactured in Switzerland. Sizes range from '8' which is the coarsest down to 6/0 which is the finest. The teeth are uniformly honed to ensure the most accurate and rapid cut

Choice of Saw blade will depend on the material being sawn, its thickness and nature of the job. For delicate work, and when cutting very thin material you should use a finer blade, but for general purpose cutting, choose a heavier blade as breakage is reduced.

- A\*F Swiss Gold Shark Brand
- Round back to facilitate cutting of curves
- Sizes: 6/0 to 8 (Fine to Coarse)
- Fits majority of piercing saw frames
- Packs of 12 blades
- In specially hardened steel
- Length 130mm

Dimensions:

- Cut x (Thickness x Height\*) x Teeth per CM

\*lower edge to top of teeth

Code	Description	UOM	Price
P1146M	6/0 Cut (0.18 x 0.34mm) 30 Teeth	Bund*12	<b>£2.30</b>
P1147M	5/0 Cut (0.20 x 0.40mm) 27 Teeth	Bund*12	<b>£1.95</b>
P1148M	4/0 Cut (0.22 x 0.46mm) 24 Teeth	Bund*12	<b>£1.95</b>
P1149M	3/0 Cut (0.25 x 0.50mm) 22 Teeth	Bund*12	<b>£1.95</b>
P1150M	2/0 Cut (0.28 x 0.56mm) 21 Teeth	Bund*12	<b>£1.95</b>
P1151M	0 Cut (0.30 x 0.60mm) 20 Teeth	Bund*12	<b>£1.95</b>
P1152M	1 Cut (0.32 x 0.64mm) 18 Teeth	Bund*12	<b>£1.95</b>
P1153M	2 Cut (0.35 x 0.70mm) 17 Teeth	Bund*12	<b>£1.95</b>
P1154M	3 Cut (0.38 x 0.75mm) 16 Teeth	Bund*12	<b>£1.95</b>

P1155M	4 Cut (0.40 x 0.79mm) 15 Teeth	Bund*12	<b>£1.95</b>
P1156M	5 Cut (0.42 x 0.85mm) 13 Teeth	Bund*12	<b>£1.95</b>
P1157M	6 Cut (0.45 x 0.90mm) 12 Teeth	Bund*12	<b>£1.95</b>
P1158M	8 Cut (0.50 x 1.08mm) 12 Teeth	Bund*12	<b>£1.95</b>

Price breaks available, see website

### Bergeon "Old Gold" Saw Blades



Bergeon 6651 - Swiss Made

- Bergeon "Old Gold" Range
- For all metals
- Round back to facilitate cutting of curves
- Sizes: 8/0 to 8 (Fine to Coarse)
- Fits majority of piercing saw frames
- Packs of 12 blades
- In specially hardened steel
- Length 130mm

The teeth are uniformly honed to ensure the most accurate and rapid cut

Code	Description	UOM	Price
P47552	8/0 Cut (0.16 x 0.32mm) 38.5 Teeth	Bund*12	<b>£2.75</b>
P1161M	6/0 Cut (0.18 x 0.36mm) 32 Teeth	Bund*12	<b>£2.55</b>
P1162M	5/0 Cut (0.20 x 0.40mm) 28 Teeth	Bund*12	<b>£2.40</b>
P1163M	4/0 Cut (0.22 x 0.44mm) 26.5 Teeth	Bund*12	<b>£2.35</b>
P1164M	3/0 Cut (0.24 x 0.48mm) 23.5 Teeth	Bund*12	<b>£2.20</b>
P1165M	2/0 Cut (0.26 x 0.52mm) 22 Teeth	Bund*12	<b>£2.20</b>
P1166M	0 Cut (0.28 x 0.56mm) 20.5 Teeth	Bund*12	<b>£2.20</b>
P1167M	1 Cut (0.30 x 0.60mm) 19 Teeth	Bund*12	<b>£2.20</b>
P1168M	2 Cut (0.34 x 0.68mm) 17.5 Teeth	Bund*12	<b>£2.20</b>
P1169M	3 Cut (0.36 x 0.72mm) 16 Teeth	Bund*12	<b>£2.20</b>
P1170M	4 Cut (0.38 x 0.76mm) 15 Teeth	Bund*12	<b>£2.20</b>
P1171M	5 Cut (0.40 x 0.80mm) 14 Teeth	Bund*12	<b>£2.20</b>
P1172M	6 Cut (0.44 x 0.84mm) 13.5 Teeth	Bund*12	<b>£2.20</b>
P1173M	8 Cut (0.50 x 1.10mm) 11 Teeth	Bund*12	<b>£2.20</b>

Price breaks available, see website

### Cousins Saw Blades



Cousins - German Made

Our made in Germany brand of saw blades are made from hardened and tempered steel and are ideal for sawing near enough anything you would need to use them on in the jewellery and horological industries.

- Ideal for bone, pearl and any other hard or soft metals
- Can be also be used in fine veneers in marquetry or for delicate cutting of wood
- Round back to facilitate cutting of curves
- Sizes: 8/0 to 4 (Fine to Coarse)
- Fits majority of piercing saw frames
- Packs of 12 blades
- In specially hardened steel
- Length 130mm
- Made in Germany

Dimensions:

- Cut x (Thickness x Height\*) x Teeth per CM

\*lower edge to top of teeth

Code	Description	UOM	Price
S35871	8/0 Cut (0.14 x 0.28mm) 40 Teeth	Bund*12	<b>£2.28</b>
S35870	7/0 Cut (0.16 x 0.32mm) 36 Teeth	Bund*12	<b>£1.95</b>
S35869	6/0 Cut (0.18 x 0.36mm) 32 Teeth	Bund*12	<b>£1.70</b>
S35868	5/0 Cut (0.20 x 0.40mm) 28 Teeth	Bund*12	<b>£1.58</b>

<b>S35867</b>	4/0 Cut (0.22 x 0.44mm)	26.5 Teeth	Bund*12	<b>£1.45</b>
<b>S35866</b>	4/0 Cut (0.24 x 0.48mm)	23.5 Teeth	Bund*12	<b>£1.45</b>
<b>S35865</b>	2/0 Cut (0.26 x 0.52mm)	22 Teeth	Bund*12	<b>£1.45</b>
<b>S35864</b>	0 Cut (0.28 x 0.58mm)	20.5 Teeth	Bund*12	<b>£1.45</b>
<b>S35863</b>	1 Cut (0.30 x 0.63mm)	19 Teeth	Bund*12	<b>£1.45</b>
<b>S35862</b>	2 Cut (0.34 x 0.70mm)	17.5 Teeth	Bund*12	<b>£1.45</b>
<b>S35861</b>	3 Cut (0.36 x 0.74mm)	16 Teeth	Bund*12	<b>£1.45</b>
<b>S35860</b>	4 Cut (0.38 x 0.80mm)	15 Teeth	Bund*12	<b>£1.45</b>

Price breaks available, see website

## Economy Saw Blade Set

This economy set is ideal as a starter pack, for students or for the occasional work. 2 dozen saw blades, across 6 grits, at a great value price, make this an essential addition to any toolbox



- 1 Gross, 144 blades
- 6 grits: 4/0, 3/0, 2/0, 1/0, 1 & 2
- Ideal for bone, pearl and any other hard or soft metals
- Fits majority of piercing saw frames
- Supplied in plastic wallet
- Length 130mm

Code	Description	UOM	Price
<b>S40300</b>	Saw Blade Set	EACH	<b>£3.95</b>

## Adjustable Saw Frames

Strong frames forged in the traditional style from high quality, polished steel with either natural wood or black varnished wooden handles. Large thumb screws and serrated clamps grip blades firmly and make replacement easy. Adjustable frames also make use of broken blades.

- Adjustable piecing saw frames
- Traditional saws to cut pieces to shapes of your design
- Wooden, rubber or plastic handles

Dimension: Depth of saw frame

### 65mm (2½") Depth Saw Frame



- Wooden handle
- Made in India

Code	Description	UOM	Price
<b>S39566</b>	65mm (2½") Depth Saw Frame	EACH	<b>£3.65</b>

### 65mm (2½") Depth Saw Frame, Superior



- Wooden handle
- Made in Taiwan

Code	Description	UOM	Price
<b>P33901</b>	65mm (2½") Depth Saw Frame, Superior	EACH	<b>£9.90</b>

### 76mm (3") Depth Saw Frame



- Wooden handle

Code	Description	UOM	Price
<b>P4798</b>	76mm (3") Depth Saw Frame	EACH	<b>£4.95</b>

### 76mm (3") Depth Saw Frame - Rubber Handle



- Rubber Handle

Code	Description	UOM	Price
<b>S39567</b>	76mm (3") Depth Saw Frame - Rubber Handle	EACH	<b>£6.95</b>

### 100mm (4") Depth Saw Frame



- Plastic handle

Code	Description	UOM	Price
<b>P4799</b>	100mm (4") Depth Saw Frame	EACH	<b>£7.25</b>

### 125mm (5") Depth Saw Frame



- Plastic handle

Code	Description	UOM	Price
<b>P4800</b>	125mm (5") Depth Saw Frame	EACH	<b>£7.65</b>

### 150mm (6") Depth Saw Frame



- Plastic handle

Code	Description	UOM	Price
<b>P4801</b>	150mm (6") Depth Saw Frame	EACH	<b>£7.85</b>

## Fixed Saw Frames, Deep Bow

Finely balanced, strong frames forged in the traditional style from high quality, polished steel with natural wood varnished handles. Large thumb screws and serrated clamps grip blades firmly and make replacement easy.

- Light weight and traditional shape wooden handles
- Deep Bow, ideal to saw the largest items of work

### 88mm (3½") Depth Saw Frame



Code	Description	UOM	Price
<b>P33902</b>	88mm (3½") Depth Saw Frame	EACH	<b>£3.95</b>

### 165mm (6½") Depth Saw Frame



Code	Description	UOM	Price
<b>P33903</b>	165mm (6½") Depth Saw Frame	EACH	<b>£4.95</b>

**PRICE PROMISE GUARANTEE** ✓

Beeswax Lubricating Block

See Page 1170



**www.** Online Discounts

Archimedean hand Drill

See Page 660



**290mm (11½") Depth Saw Frame**



Code	Description	UOM	Price
P33904	290mm (11½") Depth Saw Frame	EACH	£5.50

**300mm (12") Depth Saw Frame**



• Heavy Duty Frame

Code	Description	UOM	Price
S35026	300mm (12") Depth Saw Frame	EACH	£5.95

**SCROLL SAW**

**Proxxon Scroll Saw**



Proxxon DS230/E

- Cuts waxes, gold, silver, copper, brass and plastics with standard piercing saw blades and wax saw blades. (See full range of sizes of piercing and wax saw blades, sold seperately).
- Saw pieces with ease any direction.
- Reduces blade breakage
- The ideal machine for that delicate project: wax cutting, model making and precision work.
- Cuts soft wood (e.g. Balsa) up to 40mm, hard wood up to approx. 10mm, plastic (including PC cards) up to approx. 4mm and non-ferrous metals up to 2mm. Very stable ribbed die-cast aluminium saw frame with 300mm throat. Blade guide with intergrated blower. Height adjustable head (3 postions).

- Blade usage is improved as the head may be lowered in two steps, making new blade teeth available. This effectively triples blade life.
- The lowest head position still allows blades, shortened by 60mm, to be used.
- Machined workable of die-cast aluminium, 160 x 160mm. ABS plastic body with side sliding panel for removal of saw dust. VDE approved 220-240V Motor (85W) for prolonged, low noise performance. Quiet, wear-resistant toothed belt drive running in a ball bearing. Electronically controllable stroke rate from approx. 150-2500/min. Adjustable fence and mitre stop with scale.

Code	Description	UOM	Price
S19250	Proxxon Scroll Saw DS230/E	EACH	£105.00

**SCISSORS, SCALPELS & KNIVES**

Cousins range of scalpels & scissors, useful for all types of work.

Essential for jobbing with uses varying from cutting wax models for creating air holes during the Delft casting process, mould casting and general cutting, etching, scribing, retouching stencil layouts and paste tips.

**Cutting Knife, Bergeon**



- Bergeon 1036
- With synthetic, gel type handle.
- Length 145mm

Code	Description	UOM	Price
K0891	Bergeon 1036 Cutting Knife	EACH	£17.95

**Scalpel, All Purpose**



Scalpel - Modeller's - Made in USA

Improved with a soft-grip handle, this is the most popular style knife of its type. New technology assures sharper blades of better temper than ever before. Knurled tightening knob for the chuck.

- Fast, easy & simple blade replacement
- Simply rotate the knurled bottom cap and the four jaw chuck holding the blade will release
- Non slip, soft-grip handle, giving excellent grip
- Made in the USA

Dimensions:

- Overall length: 150mm
- Blade cutting edge size: 25mm
- Weight: 11g

Code	Description	UOM	Price
S1478	Modeller's Scalpel	EACH	£3.75
S1479	Modeller's Scalpel Blades	PACK*5	£1.85

**Wax Scalpel Carving Kit**

See Page 1111



**Precision Scalpel**



Scalpel Set - Comfort Handle - Multi Blade

This kit is essential for jobbing, its uses vary from cutting in wax models, creating air holes during the delft casting process, etching, scribing, retouching stencil layouts and paste tips.

- Comfort handle
- Includes 5 x SK5 blades
- With safety cap

Code	Description	UOM	Price
K47888	Precision Scalpel with Comfort Grip	EACH	£3.25

**Scalpel (Blades, large fitting) Sterilised**

Scalpel - Surgical - Sterilised - Universal Large Fitting Blades

- Handles, large fitting and blades
- Universal blades, large fitting
- Fitting gap 25mm long
- Quality sterilised surgical blades
- Packs of 100
- Single use
- Carbon steel
- Indian

Caution: Blades are incredibly sharp

**Scalpel, Metal Handle (large fitting) VALUE**



Takes universal blades, large fitting

- Length 140mm
- Steel
- For Blades 20, 21, 22 & 24

Code	Description	UOM	Price
S37166	Scalpel, Metal Handle (large fitting)	EACH	£1.50

**No.20 Sterilised Universal Blades, Large Fitting VALUE**



Universal blades, large fitting - Fitting gap 25mm long

- For Scalpel Handle S37166
- Quality sterilised surgical blades
  - Packs of 100
  - Single use
  - Carbon steel
  - Indian

Code	Description	UOM	Price
S36358	No.20 Sterilised Universal Blades, Large Fitting	PACK*100	£7.95



**BROWSE & BUY**

**No.21 Sterilised Universal Blades, Large Fitting**



Universal blades, large fitting - Fitting gap 25mm long

For Scapel Handle S37166

- Quality sterilised surgical blades
- Packs of 100
- Single use
- Carbon steel
- Indian

Code	Description	UOM	Price
S36359	No.21 Sterilised Universal Blades, Large Fitting	PACK*100	£7.95

**No.22 Sterilised Universal Blades, Large Fitting**



Universal blades, large fitting - Fitting gap 25mm long

For Scapel Handle S37166

- Quality sterilised surgical blades
- Packs of 100
- Single use
- Carbon steel
- Indian

Code	Description	UOM	Price
S36360	No.22 Sterilised Universal Blades, Large Fitting	PACK*100	£7.95

**No.24 Sterilised Universal Blades, Large Fitting**



Universal blades, large fitting - Fitting gap 25mm long

For Scapel Handle S37166

- Quality sterilised surgical blades
- Packs of 100
- Single use
- Carbon steel
- Indian

Code	Description	UOM	Price
S36361	No.24 Sterilised Universal Blades, Large Fitting	PACK*100	£7.95

**Scalpel (Blades, small fitting) Sterilised**

Scalpel - Surgical - Sterilised - Universal Small Fitting Blades

- Universal Blades, Small Fitting
- Fitting gap 18mm long
- Quality sterilised surgical blades
- Packs of 100
- Single use
- Carbon steel
- Indian

Caution: Blades are incredibly sharp

**Scalpel, Metal Handle (small fitting)**



- Takes Universal Blades, Small Fitting
- Stainless steel
- 130mm overall length
- Takes Universal Blades, Small Fitting

• For Blades 10, 11, 12 & 15

Code	Description	UOM	Price
S36481	Scalpel, Metal Handle (small fitting)	EACH	£1.25

**Scalpel, Plastic Handle (small fitting)**



- Takes Universal Blades, Small Fitting
- Overall length 130mm
- Takes Universal Blades, Small Fitting
- For Blades 10, 11, 12 & 15

Code	Description	UOM	Price
S36316	Scalpel, Plastic Handle (small fitting)	EACH	£1.25

**No.10 Sterilised Universal Blades, Small Fitting**



Universal blades, small fitting - Fitting gap 18mm long

For Scapel Handles S36481 & S36316

- Quality sterilised surgical blades
- Packs of 100
- Single use
- Carbon steel
- Indian

Code	Description	UOM	Price
S36354	No.10 Sterilised Universal Blades, Small Fitting	PACK*100	£7.95

**No.11 Sterilised Universal Blades, Small Fitting**



Universal blades, small fitting - Fitting gap 18mm long

For Scapel Handles S36481 & S36316

- Quality sterilised surgical blades
- Packs of 100
- Single use
- Carbon steel
- Indian

Code	Description	UOM	Price
S36355	No.11 Sterilised Universal Blades, Small Fitting	PACK*100	£7.95

**No.12 Sterilised Universal Blades, Small Fitting**



Universal blades, small fitting - Fitting gap 18mm long

For Scapel Handles S36481 & S36316

- Quality sterilised surgical blades
- Packs of 100
- Single use
- Carbon steel
- Indian

Code	Description	UOM	Price
S36356	No.12 Sterilised Universal Blades, Small Fitting	PACK*100	£7.95

**No.15 Sterilised Universal Blades, Small Fitting**



Universal blades, small fitting - Fitting gap 18mm long

For Scapel Handles S36481 & S36316

- Quality sterilised surgical blades
- Packs of 100
- Single use
- Carbon steel
- Indian

Code	Description	UOM	Price
S36357	No.15 Sterilised Universal Blades, Small Fitting	PACK*100	£7.95

**Scalpel (Blades, small fitting) Swann Morton**

Scalpel - Swann Morton - Universal Blades (small fitting)

- Swann Morton
- Small Fitting Blades
- Fitting gap 18mm long
- Non Sterile
- Carbon Steel
- Blades supplied in packs of 5 pieces

Swan Morton makes the sharpest cutting tools on the planet and are the best to cut casting moulds.

Founded in Sheffield in 1932, Swann-Morton has become a world leader in the manufacture of surgical blades, scalpels and handles. It is a name respected globally for quality, precision, consistency and reliability and recognised for combining traditional blade making skills with the latest technology.

The Swann-Morton Blade Remover allows for safe and easy removal of all sizes of scalpel blade from both No.3 and No.5a handles. Unlike most sharp removal devices it is supplied sterile dispenser making it safe and easy to dispose of those old blades.

The Scalpel Handles range also includes the ergonomically designed Stainless steel and plastic handles, with their smooth tapered shaped body offering precise fingertip control which makes them popular.

- All blades are non sterile, supplied in packs of five and made from carbon steel.
- Made in UK

**Scalpel, Acrylic Handle**



- Takes Universal Blades, Small Fitting
- Swann Morton Type 5A
- Metal blade mount with easy grip acrylic handle
- For blades 10, 10A, 11 & 12

Code	Description	UOM	Price
S9531	Scalpel, Acrylic Handle	EACH	£9.55

**Guillotines & Shears**  
See Page 833

PRICE PROMISE GUARANTEE

**Scalpel, Metal Handle**



- Takes Universal Blades, Small Fitting
- Swann Morton Type 3
- Metal blade mount with all metal handle
- For blades 10, 10A, 11 & 12

Code	Description	UOM	Price
S9530	Scalpel, Metal Handle	EACH	£3.95

**No.10 SM Blades, Small Fitting**

Swann Morton blades, small fitting - Fitting gap 18mm long



For Scapel Handles S9531 & S9530

- Swann Morton
- Non Sterile
- Carbon Steel
- Blades supplied in packs of 5 pieces

Code	Description	UOM	Price
S9532	No.10 SM Blades, Small Fitting	PACK*5	£0.90

**No.10A SM Blades, Small Fitting**

Swann Morton blades, small fitting - Fitting gap 18mm long



For Scapel Handles S9531 & S9530

- Swann Morton
- Non Sterile
- Carbon Steel
- Blades supplied in packs of 5 pieces

Code	Description	UOM	Price
S9533	No.10A SM Blades, Small Fitting	PACK*5	£0.90

**No.11 SM Blades, Small Fitting**

Swann Morton blades, small fitting - Fitting gap 18mm long



For Scapel Handles S9531 & S9530

- Swann Morton
- Non Sterile
- Carbon Steel
- Blades supplied in packs of 5 pieces

Code	Description	UOM	Price
S9534	No.11 SM Blades, Small Fitting	PACK*5	£0.90

**No.12 SM Blades, Small Fitting**

Swann Morton blades, small fitting - Fitting gap 18mm long



For Scapel Handles S9531 & S9530

- Swann Morton
- Non Sterile

- Carbon Steel
- Blades supplied in packs of 5 pieces

Code	Description	UOM	Price
S9535	No.12 SM Blades, Small Fitting	PACK*5	£0.90

**Scalpel Blade Removers**



Swann Morton

The safest way to remove used scalpel blades. Either the single use disposable blade removers or the multi use box. Just insert blade into the box, push down on tab and pull out the scalpel handle. Blade remains harmlessly in the box which is discarded when full.

Code	Description	UOM	Price
S9536	Blade Remover (single use)	PACK*50	£5.80
B47551	Blade Remover (multi use)	EACH	£1.65

Price breaks available, see website

**Scissors**



Scissors

- S39260
- Broad, curved tips
  - Stainless Steel
  - 115mm overall length
  - 14mm Tip length

- S3926
- Fine point tips
  - Stainless Steel
  - 115mm overall length
  - 22mm tip length

Code	Description	UOM	Price
S39260	Broad Tip Scissors	EACH	£1.50
S39261	Fine Tip, Scissors	EACH	£1.50



**Online Discounts**

Wax Carving Tools

See Page 1109



**Scissors (Crown) A&F**



A\*F Swiss - Crown Scissors

Used for cutting thin precious metal sheet especially gold leaf. Top quality, beautifully finished in nickel plated steel.

- One serrated jaw or non serrated jaws
- Curved or straight tips
- Brilliant for cutting thin precious metal sheet or general use
- Polished finish
- Stainless steel
- 115mm overall length

Code	Description	UOM	Price
S40298	A*F Swiss (Curved Tips) One Serrated Jaw	EACH	£10.50
S40299	A*F Swiss (Curved Tips) Smooth Jaws	EACH	£10.50
S40296	A*F Swiss (Straight Tips) One Serrated Jaw	EACH	£7.50
S40297	A*F Swiss (Straight Tips) Smooth Jaws	EACH	£9.95

**Scissors (Crown) Cousins**



Cousins Swiss Style - Crown Scissors

Used for cutting thin precious metal sheet especially gold leaf. Top quality, beautifully finished in nickel plated steel.

- One serrated jaw or non serrated jaws
- Curved or straight tips
- Brilliant for cutting thin precious metal sheet or general use
- Polished finish
- Stainless steel
- 115mm overall length

Code	Description	UOM	Price
S48604	Cousins Swiss Style (Curved Tips) One Serrated Jaw	EACH	£3.95
S48605	Cousins Swiss Style (Curved Tips) Smooth Jaws	EACH	£3.95
S48606	Cousins Swiss Style (Straight Tips) One Serrated Jaw	EACH	£3.95
S48607	Cousins Swiss Style (Straight Tips) Smooth Jaws	EACH	£3.95

Clay Casting by Delft

See Page 1002





SCREW EXTRACTION

Screw Extractor



Bergeon 30209 - Swiss Made

Removal of damaged watch screws with precise alignment of special milled tips and support.

Reversible Screw Extractors:

- 30209A = Ø0.40mm & Ø0.50mm
- 30209B = Ø0.60mm & Ø0.70mm
- 30209C = Ø0.80mm & Ø1.00mm

Code	Description	UOM	Price
S1517	Screw Extractor Tool	EACH	£62.95
S1518	Ø0.40mm & Ø0.50mm Extractor, Bergeon 30209A	EACH	£8.25
S1519	Ø0.60mm & Ø0.70mm Extractor, Bergeon 30209B	EACH	£8.25
S1520	Ø0.80mm & Ø1.00mm Extractor, Bergeon 30209C	EACH	£8.25

Crosshead (Steel), Cousins

Cousins Euro - Crosshead - Steel

- Crosshead
- Good quality
- Made in E.U

- Sizes available:
- Ø1.40mm
  - Ø1.60mm
  - Ø2.00mm
  - Ø2.50mm
  - Ø3.00mm

Replacements for screwdrivers:

- S36672 to S36676

Code	Description	UOM	Price
S36677	Ø1.40mm Crosshead Blades, Cousins	PACK*5	£3.95
S36678	Ø1.60mm Crosshead Blades, Cousins	PACK*5	£3.95
S36679	Ø2.00mm Crosshead Blades, Cousins	PACK*5	£3.95
S36680	Ø2.50mm Crosshead Blades, Cousins	PACK*5	£3.95
S36681	Ø3.00mm Crosshead Blades, Cousins	PACK*5	£3.95



Flat (Stainless Steel), Bergeon 30080



Bergeon 30080 - Straight (Flat) - Steel

- Bergeon 30080 Range
- Swiss Made
- 10 pieces per size
- Colour coded
- Stainless steel

Code	Description	UOM	Price
S2948	Ø0.50mm (Orange) Bergeon	PACK*10	£8.75
S2949	Ø0.60mm (White) Bergeon	PACK*10	£8.75
S7659	Ø0.70mm, Bergeon	PACK*10	£8.75
S2950	Ø0.80mm (Yellow) Bergeon	PACK*10	£8.75
S7660	Ø0.90mm, Bergeon	PACK*10	£8.75
S2951	Ø1.00mm (Black) Bergeon	PACK*10	£8.75
S7661	Ø1.10mm, Bergeon	PACK*10	£8.75
S2952	Ø1.20mm (Red) Bergeon	PACK*10	£8.75
S7662	Ø1.30mm, Bergeon	PACK*10	£8.75
S2953	Ø1.40mm (Grey) Bergeon	PACK*10	£8.75
S7663	Ø1.50mm, Bergeon	PACK*10	£8.75
S2954	Ø1.60mm (Violet) Bergeon	PACK*10	£8.75
S7664	Ø1.80mm, Bergeon	PACK*10	£8.75
S2955	Ø2.00mm (Green) Bergeon	PACK*10	£8.75
S7665	Ø2.20mm, Bergeon	PACK*10	£8.75
S2956	Ø2.50mm (Blue) Bergeon	PACK*3	£4.50
S2957	Ø3.00mm (Brown) Bergeon	PACK*3	£4.50

Flat (Stainless Steel), A\*F Swiss

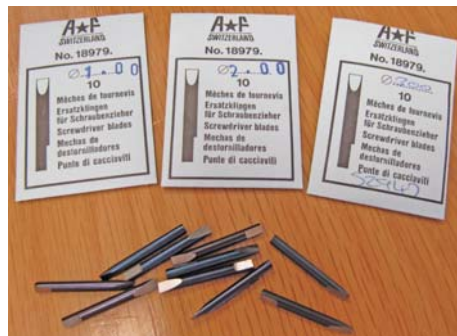

A\*F Swiss - Straight (Flat) - Steel

- A\*F Swiss Range
- 10 pieces per size
- Colour coded
- Stainless steel

Code	Description	UOM	Price
S2938	Ø0.50mm (Dark Green) A*F Swiss	PACK*10	£3.85
S2939	Ø0.60mm (Pink) A*F Swiss	PACK*10	£3.85
S2940	Ø0.80mm (Yellow) A*F Swiss	PACK*10	£4.75
S2941	Ø1.00mm (Black) A*F Swiss	PACK*10	£4.85
S2942	Ø1.20mm (Red) A*F Swiss	PACK*10	£4.85
S2943	Ø1.40mm (Grey) A*F Swiss	PACK*10	£4.85
S2944	Ø1.60mm (Violet) A*F Swiss	PACK*10	£5.95
S2945	Ø2.00mm (Green) A*F Swiss	PACK*10	£5.95
S2946	Ø2.50mm (Blue) A*F Swiss	PACK*10	£7.50
S2947	Ø3.00mm (Brown) A*F Swiss	PACK*10	£7.50

SCREWDRIVERS & SCREWDRIVER BLADE SHARPENERS

SCREWDRIVER BLADES & FIXING SCREWS

Full range of screwdriver blades and fixing screws available from Switzerland.

For quick identification of blade sizes when ordering replacements use the color code system, measure, or see markings size found on the top end of the screwdriver.

Blade standards:

- Cousins quality screwdriver blades, value for money
- Standard A\*F Swiss made from durable high alloy steel.
- Extra high grade Bergeon Swiss hardened stainless steel very tough hard exceptional durability.
- Standard Bergeon steel range made from high alloy steel durable and an old favorite amongst traditional watch repairers/makers.
- High grade Bergeon non-magnetic high alloy screwdriver blades durable 100% anti-magnetic.

PRICE PROMISE GUARANTEE

Sharpening Stones on Wooden Base

See Page 1022



Screwdriver Sharpening Tools

See Page 1000



Flat (Stainless Steel), Cousins



Cousins screwdriver blades - value for money - Straight (Flat) - Steel

- Cousins range of screwdriver blades
- Pack of 10
- Stainless steel

Available in:

- Ø0.50mm, Ø0.60mm, Ø0.80mm, Ø1.00mm
- Ø1.20mm, Ø1.40mm, Ø1.60mm, Ø2.00mm
- Ø2.50mm & Ø3.00mm

Code	Description	UOM	Price
S35364	Ø0.50mm, Cousins Value	PACK*10	£2.95
S35365	Ø0.60mm, Cousins Value	PACK*10	£2.95
S35366	Ø0.80mm, Cousins Value	PACK*10	£2.95
S35367	Ø1.00mm, Cousins Value	PACK*10	£2.95
S35368	Ø1.20mm, Cousins Value	PACK*10	£2.95
S35369	Ø1.40mm, Cousins Value	PACK*10	£2.95
S35370	Ø1.60mm, Cousins Value	PACK*10	£2.95
S35371	Ø2.00mm, Cousins Value	PACK*10	£2.95
S35372	Ø2.50mm, Cousins Value	PACK*10	£2.95
S35373	Ø3.00mm, Cousins Value	PACK*10	£2.95

**Flat (Declafor, Anti Magnetic), Bergeon 8899**



Bergeon 8899 - Straight (Flat) - Non Magnetic  
 The Bergeon Swiss 100% anti-magnetic blades are made from a super alloy know as declafor. This material is softer than the hardened stainless steel blades that are supplied with other sets.

- Softer blades will not mark the screws or plates
- 100% anti-magnetic
- Bergeon 8899 range
- Will also fit Bergeon 30080 range
- Swiss Made

Code	Description	UOM	Price
S41944	Ø0.50mm Antimagnetic Blades	PACK*3	£7.50
S41945	Ø0.60mm Antimagnetic Blades	PACK*3	£7.50
S41946	Ø0.80mm Antimagnetic Blades	PACK*3	£7.50
S41947	Ø1.00mm Antimagnetic Blades	PACK*3	£7.50
S41948	Ø1.20mm Antimagnetic Blades	PACK*3	£7.50
S41949	Ø1.40mm Antimagnetic Blades	PACK*3	£7.50
S41950	Ø1.60mm Antimagnetic Blades	PACK*3	£7.50
S41951	Ø2.00mm Antimagnetic Blades	PACK*3	£7.50
S41952	Ø2.50mm Antimagnetic Blades	PACK*3	£7.50
S41953	Ø3.00mm Antimagnetic Blades	PACK*3	£7.50

**Flat (Hardened Stainless Steel), Bergeon 6899M**



Bergeon 6899M - Straight (Flat) - Hardened Stainless Steel

- Pack\*10 or pack\*2
- 10 supplied in an envelope, 2 supplied in a tube
- Bergeon 6899M Range
- Swiss Made
- Hardened Stainless Steel
- Colour coded

Code	Description	UOM	Price
S45211	Ø0.50mm (Orange) SS	PACK*2	£3.00
S34415	Ø0.50mm (Orange) SS	PACK*10	£8.75
S45212	Ø0.60mm (White) SS	PACK*2	£3.00
S34416	Ø0.60mm (White) SS	PACK*10	£8.75
S45213	Ø0.80mm (Yellow) SS	PACK*2	£3.00
S34417	Ø0.80mm (Yellow) SS	PACK*10	£8.75
S45214	Ø1.00mm (Black) SS	PACK*2	£3.00
S34418	Ø1.00mm (Black) SS	PACK*10	£8.75
S45215	Ø1.20mm (Red) SS	PACK*2	£3.00
S34419	Ø1.20mm (Red) SS	PACK*10	£8.75
S45216	Ø1.40mm (Grey) SS	PACK*2	£3.00
S34420	Ø1.40mm (Grey) SS	PACK*10	£8.75
S45217	Ø1.60mm (Violet) SS	PACK*2	£3.00
S34421	Ø1.60mm (Violet) SS	PACK*10	£8.75
S45218	Ø2.00mm (Green) SS	PACK*2	£3.00
S34422	Ø2.00mm (Green) SS	PACK*10	£8.75
S45219	Ø2.50mm (Blue) SS	PACK*2	£3.00

S34423	Ø2.50mm (Blue) SS	PACK*10	£8.75
S45220	Ø3.00mm (Brown) SS	PACK*2	£3.00
S34424	Ø3.00mm (Brown) SS	PACK*10	£8.75

**Flat (Hardened HSS, Parallel), Bergeon 7895**



Bergeon 7895 - Parallel Flanks with Polished Angles

- Hardened High Speed Steel 60-62 HRC
- Parallel blades developed for the highest ultra precision standard of prestigious watch manufacturers. Straight sided blade tips fit screw slots perfectly to avoid damage.

- Tube of 2
- Bergeon 7895 Range
- Swiss Made
- Parallel Flanks with Polished Angles
- Supplied in colour coded tube

Code	Description	UOM	Price
S45935	Ø0.50mm Parallel Blade	PACK*2	£17.50
S45936	Ø0.60mm Parallel Blade	PACK*2	£17.50
S45937	Ø0.70mm Parallel Blade	PACK*2	£17.50
S45938	Ø0.80mm Parallel Blade	PACK*2	£17.50
S45939	Ø0.90mm Parallel Blade	PACK*2	£17.50
S45940	Ø1.00mm Parallel Blade	PACK*2	£17.50
S45941	Ø1.10mm Parallel Blade	PACK*2	£17.50
S45942	Ø1.20mm Parallel Blade	PACK*2	£17.50
S45943	Ø1.30mm Parallel Blade	PACK*2	£17.50
S45944	Ø1.40mm Parallel Blade	PACK*2	£17.50
S45945	Ø1.50mm Parallel Blade	PACK*2	£17.50
S45946	Ø1.60mm Parallel Blade	PACK*2	£17.50
S45947	Ø2.00mm Parallel Blade	PACK*2	£17.50
S45948	Ø2.20mm Parallel Blade	PACK*2	£17.50
S45949	Ø2.50mm Parallel Blade	PACK*2	£17.50
S45950	Ø3.00mm Parallel Blade	PACK*2	£17.50

**Flat (Stainless Steel, Stepped), Cousins**



Cousins screwdriver blades - value for money - Straight (Flat) - Steel

- Cousins range of screwdriver blades
- Pack of 10
- Stainless steel
- With stepped fixing
- For our screwdriver set S47877

Available in:  
 • Ø0.50mm, Ø0.60mm, Ø0.80mm, Ø1.00mm

- Ø1.20mm, Ø1.40mm, Ø1.60mm, Ø2.00mm
- Ø2.50mm & Ø3.00mm

Code	Description	UOM	Price
S47879	Ø0.60mm Blade	PACK*5	£1.95
S47880	Ø0.80mm Blade	PACK*5	£1.95
S47881	Ø1.00mm Blade	PACK*5	£1.95
S47882	Ø1.20mm Blade	PACK*5	£1.95
S47883	Ø1.40mm Blade	PACK*5	£1.95
S47884	Ø1.60mm Blade	PACK*5	£1.95
S47887	Ø1.60mm Blade (Crosshead)	PACK*5	£1.95
S47885	Ø1.80mm Blade	PACK*5	£1.95
S47886	Ø2.00mm Blade	PACK*5	£1.95

**Screws for Blade Fixing**

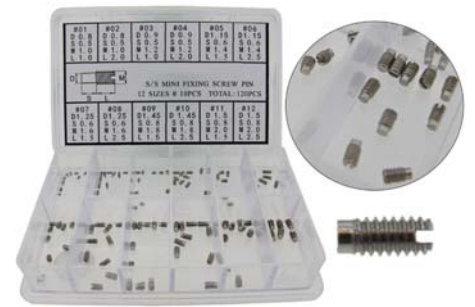

Blade Fixing Screws

These are very handy spares to have while you or your staff are busy changing batteries, securing watch cases or adjusting bracelets. Having them close to hand will be useful in busy periods.

See also our range of screwdriver sharpening tools, see the links below

- 12 sizes available
- Pack\*120
- Replacements 20 pieces per pack
- Stainless steel
- Can be used in a variety of tools including screwdrivers and spring bar tools

Dimensions:

- Thread diameter x thread length x base diameter x base length

Code	Description	UOM	Price
S40348	Blade Fixing Screw Set	PACK*120	£8.95
S40349	Ø1.00 x 1.00 x Ø0.80 x 0.50mm	PACK*20	£1.95
S40350	Ø1.00 x 2.00 x Ø0.80 x 0.50mm	PACK*20	£1.95
S40351	Ø1.20 x 1.00 x Ø0.90 x 0.50mm	PACK*20	£1.95
S40352	Ø1.20 x 2.00 x Ø0.90 x 0.50mm	PACK*20	£1.95
S40353	Ø1.40 x 1.50 x Ø1.15 x 0.60mm	PACK*20	£1.95
S40354	Ø1.40 x 2.50 x Ø1.15 x 0.60mm	PACK*20	£1.95
S40355	Ø1.60 x 1.50 x Ø1.25 x 0.60mm	PACK*20	£1.95
S40356	Ø1.60 x 2.50 x Ø1.25 x 0.60mm	PACK*20	£1.95
S40357	Ø1.80 x 1.50 x Ø1.45 x 0.80mm	PACK*20	£1.95
S40358	Ø1.80 x 2.50 x Ø1.45 x 0.80mm	PACK*20	£1.95
S40359	Ø2.00 x 1.50 x Ø1.50 x 0.80mm	PACK*20	£1.95
S40360	Ø2.00 x 2.50 x Ø1.50 x 0.80mm	PACK*20	£1.95

**Screws for Blade Fixing, Bergeon Swiss**



Bergeon Swiss - Blade Fixing Screws

These are very handy spares to have while you or your staff are busy changing batteries, securing watch cases or adjusting bracelets.

Having them close to hand will be useful in busy periods.

See also our range of screwdriver sharpening tools see links below

- 10 pieces per pack
- Suitable for Bergeon or A\*F Swiss Screwdrivers

Code	Description	UOM	Price
S1480	for Screwdrivers Ø0.50mm	PACK*10	£3.15
S1481	for Screwdrivers Ø0.60mm to Ø1.60mm	PACK*10	£3.15
S1482	for Screwdrivers Ø1.80mm to Ø3.00mm	PACK*10	£3.15

## SCREWDRIVER SETS



### Revolving Stands (RS) - Wooden Cases (WC)

- A\*F Swiss, Stainless Steel
- Bergeon, Aluminium
- Bergeon, Aluminium, Anti Magnetic
- Bergeon, Chromium Plated
- Bergeon, Chromium Plated, Non Magnetic
- Bergeon, Stainless Steel
- Cousins, Stainless Steel
- Horotec, Stainless Steel
- Horotec, Stainless Steel, Parallel Blades
- Indian, Stainless Steel
- Multi Tools Drivers
- Mobile Phone Drivers

We have a large selection of screwdriver sets from all over the globe. Giving you a wide choice to suit your requirements whether you're looking for top quality Swiss or non EU which are exceptional quality for the price. Rest assured there is one to suit you criteria of work and budget.

Buying a set has the advantage of having the right screwdriver type and size to perform your repair/alteration services efficiently. The sets on stands are excellent as it keeps the working bench tidy and easy to find when needed.

Bergeon screwdriver sets are considered the Crème Della Crème of precision screwdrivers. An old favorite for generations of professional watchmakers, known for their extreme high quality.

Horotech & A\*F Swiss screwdriver sets are of an excellent quality, original established brands known throughout the world.

We also have a selection of far east sets which are exceptional value whilst maintaining a good quality.

- The majority of the screwdriver sets we supply have a range of spares blades and fixing screws
- Take a look at our selection of sharpening tools handy to maintain your screwdriver heads (see link below)
- The revolving sets have all spare blades in a compartment situated in the center



**WORLDWIDE DELIVERY**

### A\*F Swiss Stainless Steel (4 Pieces, Crosshead)



Set of 4 A\*F Philips screwdrivers with cross-point blade tips. Allow fast dismantling of modules assembled with Philips (cross head) screws.

- A\*F 18983.4
- Set of 4 crosshead screwdrivers
- In plastic wallet
- Sizes: Ø1.50, 2.00, 2.50 & 3.00mm

Code	Description	UOM	Price
S1515	4 Piece (Crosshead) A*F Swiss	PACK*4	£18.95

### A\*F Swiss Stainless Steel, Non Magnetic (5 Pieces)



Set of 5 top quality 100% antimagnetic screwdrivers. In plastic wallets with five screwdrivers and blades plus one spare blade of each size in beryllium.

- A\*F Swiss 18985
- Set of 5
- 100% non magnetic screwdrivers
- In plastic wallet
- Sizes: Ø0.60, 0.80, 1.00, 1.20 & 1.40 mm.
- With one spare blade per diameter

Replacement screwdriver blades:  
• Bergeon 4917 Range (S7667 to S7675)

Replacement screwdriver blade fixing grub screw:  
• Bergeon 30080 (S1480 to S1482)

Code	Description	UOM	Price
S1516	5 Piece (Straight) A*F Swiss - Non Magnetic	PACK*5	£22.45

### A\*F Swiss Stainless Steel (9 Pieces, RS)



#### A\*F Swiss - Revolving Stand (RS)

Our all time "Best Selling" Rotating Base Screwdriver Set. Top quality A\*F precision screwdrivers. In chromed brass with colour coded rotating heads mounted on a ball bearing. Set of nine screwdrivers on a rotating stand with 19 spare blades and 2 fixing screws.

- Stainless Steel
- Top quality precision screwdrivers
- Colour coded rotating heads mounted on ball bearings.
- 9 Pieces
- Sizes: Ø0.60, 0.80, 1.00, 1.20, 1.40, 1.60, 2.00, 2.50 & 3.00mm.
- 19 spare blades and 2 fixing screws

Replacement screwdriver blades for S1512:

- A\*F Swiss stainless steel (S2938 to S2947)
- Bergeon 6899M hardened stainless steel (S34415 to S34424)
- Cousins superior quality (S35364 to S35373)

Replacement screwdriver blade fixing grub screw:

- Bergeon 30080 (S1480 to S1482)

Replacement Screwdrivers:

- S1512A to S1512J (Ø0.50mm to Ø3.00mm)

Code	Description	UOM	Price
S1512	9 Piece (Straight) A*F Swiss - Revolving Stand	PACK*9	£41.95

### A\*F Swiss Deluxe Stainless Steel (9 Pieces, RS)



#### A\*F Swiss - Revolving Stand (RS) - Deluxe

For the most demanding watchmaker. A set of 9 A\*F precision screwdrivers and 34 spare blades. Mounted

on a rotating stand in anodised aluminium. The stand features a ball bearing for smooth and light rotation with rubber bands to facilitate turning. A heavy base ensures maximum stability.

- Deluxe version
- Stainless Steel
- Revolving aluminium base
- Top quality precision screwdrivers
- Colour coded rotating heads mounted on ball bearings.
- 9 Pieces
- Sizes: Ø0.60, 0.80, 1.00, 1.20, 1.40, 1.60, 2.00, 2.50 & 3.00mm.
- 34 spare blades

Replacement screwdriver blades for S1512:  
 • A\*F Swiss stainless steel (S2938 to S2947)  
 • Bergeon 6899M hardened stainless steel (S34415 to S34424)  
 • Cousins superior quality (S35364 to S35373)

Replacement screwdriver blade fixing grub screw:  
 • Bergeon 30080 (S1480 to S1482)

Replacement Screwdrivers:  
 • S1512A to S1512J (Ø0.50mm to Ø3.00mm)

Code	Description	UOM	Price
S38847	9 Piece (Straight) A*F Swiss - Revolving Stand Deluxe	PACK*9	£159.95

**A\*F Swiss Stainless Steel (12 Pieces, RS)**



A\*F Swiss - Revolving Stand (RS) - High Precision

Superb quality - Set of 12 screwdrivers with colour coded heads mounted on ball bearings. Developed for the highest standards of prestigious watch manufacturers. Straight sided blade tips fit screw slots perfectly to avoid damage.

- Stainless Steel
- A\*F 189.765
- 12 Pieces
- Swiss Made
- Sizes: Ø0.60, 0.70, 0.80, 0.90, 1.00, 1.20, 1.40, 1.60, 1.80, 2.00, 2.50 & 3.00mm

Replacement screwdriver blades for S1512:  
 • A\*F Swiss stainless steel (S2938 to S2947)  
 • Bergeon 6899M hardened stainless steel (S34415 to S34424)  
 • Cousins superior quality (S35364 to S35373)

Replacement screwdriver blade fixing grub screws:  
 • Bergeon 30080 (S1480 to S1482)

Code	Description	UOM	Price
S31556	12 Piece (Straight) A*F Swiss - Revolving Stand, High Precision	PACK*12	£285.00

**PRICE PROMISE GUARANTEE**

**Demagnetisers**

**See Page 657**



**Bergeon Aluminium, Ergonomic (9 Pieces, RS)**



Bergeon 7899.S09 - Ø67mm Revolving Stand (RS)

- 9 Screwdrivers
- Shank of anodized aluminium
- Handle of TPE elastomer coat
- Head of self-lubricating, synthetic POM (Derlin) material
- 1 piece per size spare blade

The new Bergeon "Swiss Made" screwdriver range of tools combine technical quality with comfort of use. The screwdrivers are provided with an elastomer membrane which ensures an ideal contact between the tool and the hand, while the octagonal head enhances the comfort.

- Blades of hardened stainless steel 54 HRC
- Revolving stand
- Coloured slots for spare blades, 1 piece each size provided
- Sizes: Ø 0.50, 0.60, 0.80, 1.00, 1.20, 1.40, 1.60, 2.00 & 2.50mm

Replacement screwdrivers:  
 • Bergeon 7899 (S34405 to S34414)

Replacement screwdriver blades:  
 • Bergeon 30080 stainless steel (S2948 to S2957)  
 • Bergeon 6899M hardened stainless steel (S34415 to S34424)  
 • Cousins superior quality (S35364 to S35373)

Replacement screwdriver blade fixing grub screw:  
 • Bergeon 30080 (S1480 to S1482)

Code	Description	UOM	Price
S32433	9 Piece Ø67mm Revolving Stand, Bergeon Aluminium	PACK*9	£130.95

**Bergeon Aluminium, Ergonomic (10 Pieces, RS)**



Bergeon 7899.S10 - Ø90mm Revolving Stand (RS)

- 10 Screwdrivers

- Shank of anodized aluminium
- Handle of TPE elastomer coat
- Head of self-lubricating, synthetic POM (Derlin) material
- 2 piece per size spare blade

The new Bergeon "Swiss Made" screwdriver range of tools combine technical quality with comfort of use. The screwdrivers are provided with an elastomer membrane which ensures an ideal contact between the tool and the hand, while the octagonal head enhances the comfort.

- Blades of hardened stainless steel
- Revolving stand
- Coloured slots for spare blades, 1 piece each size provided
- Sizes: Ø 0.50, 0.60, 0.80, 1.00, 1.20, 1.40, 1.60, 2.00, 2.50mm & 3.00mm

Replacement screwdrivers:  
 • Bergeon 7899 (S34405 to S34414)

Replacement screwdriver blades:  
 • Bergeon 30080 stainless steel (S2948 to S2957)  
 • Bergeon 6899M hardened stainless steel (S34415 to S34424)  
 • Cousins superior quality (S35364 to S35373)

Replacement screwdriver blade fixing grub screws:  
 • Bergeon 30080 (S1480 to S1482)

Code	Description	UOM	Price
S32274	10 Piece Ø90mm Revolving Stand, Bergeon Aluminium	PACK*10	£189.95

**Bergeon Aluminium, Ergonomic, Anti Magnetic (10 Pieces, RS)**



Bergeon 8899.S10 - Ø90mm Revolving Stand (RS)

- 10 Screwdrivers
- Shank of anodized aluminium
- Handle of TPE elastomer coat
- Head of self-lubricating, synthetic POM (Derlin) material
- Blades: Anti Magnetic, Declafor
- 2 piece per size spare blade

The Bergeon "Swiss Made" 100% anti-magnetic blades are made from a super alloy know as declafor. This material is softer than the hardened stainless steel blades that are supplied with other sets

- 100% Anti Magnetic
- Revolving stand
- 2 spare blades in separate plastic tubes

Sizes:  
 • Ø0.50mm, Ø0.60mm, Ø0.80mm, Ø1.00mm  
 • Ø1.20mm, Ø1.40mm, Ø1.60mm, Ø2.00mm  
 • Ø2.50mm, Ø3.00mm

Replacement screwdrivers:  
 • Bergeon 8899 (S38993 to S39002)

Replacement screwdriver blades:  
 • Bergeon 8899 Anti Magnetic (S41944 to S41953)

Replacement screwdriver blade fixing grub screws:

# SCREWDRIVERS & SCREWDRIVER BLADE SHARPENERS

- Bergeon 30080 (S1480 to S1482)

Code	Description	UOM	Price
S39292	10 Piece Ø90mm Revolving Stand, Bergeon Antimagnetic	EACH	£169.95

## Bergeon Aluminium, Ergonomic, Anti Magnetic (10 Pieces, WC)



Bergeon 8899.A10 - Ø90mm Revolving Stand (RS)

- 10 Screwdrivers
- Shank of anodized aluminium
- Handle of TPE elastomer coat
- Head of self-lubricating, synthetic POM (Derlin) material
- Blades: Anti Magnetic, Declafor
- 2 piece per size spare blade

The Bergeon "Swiss Made" 100% anti-magnetic blades are made from a super alloy know as declafor. This material is softer than the hardened stainless steel blades that are supplied with other sets

- 100% Anti Magnetic
- Wooden case
- 2 spare blades in separate plastic tubes

Sizes:

- Ø0.50mm, Ø0.60mm, Ø0.80mm, Ø1.00mm
- Ø1.20mm, Ø1.40mm, Ø1.60mm, Ø2.00mm
- Ø2.50mm, Ø3.00mm

Replacement screwdrivers:

- Bergeon 8899 (S38993 to S39002)

Replacement screwdriver blades:

- Bergeon 8899 Anti Magnetic (S41944 to S41953)

Replacement screwdriver blade fixing grub screws:

- Bergeon 30080 (S1480 to S1482)

Code	Description	UOM	Price
S38992	10 Piece, Wooden Case, Bergeon Antimagnetic	PACK*10	£175.00

## Bergeon Chromium Plated (3 Pieces)



- Bergeon 4063
- 3 Screwdrivers in cardboard box.
- Sizes: Ø0.50, 0.60 & 0.80mm
- With one spare blade per diameter
- Bergeon stainless steel blades

Replacement screwdrivers:

- Bergeon 30080 (S1483 to S1486)

Replacement Screwdriver Blades:

- Bergeon 30080 Stainless Steel (S2948 to S2957)
- Bergeon 6899M Hardened Stainless Steel (S34415 to S34424)

Replacement Screwdriver Blade Fixing Grub Screw:

- Bergeon 30080 (S1480 to S1482)

Code	Description	UOM	Price
S1509	3 Piece (Straight) Bergeon	PACK*3	£27.95

## Bergeon Chromium Plated (5 Pieces)



- Bergeon 2868
- 5 Screwdrivers in cardboard box.
- Contents: Ø0.50, 0.60, 0.80, 1.00, 1.20mm.
- With one spare blade per diameter
- Bergeon stainless steel blades

Replacement screwdrivers:

- Bergeon 30080 (S1483 to S1490)

Replacement screwdriver blades:

- Bergeon 30080 stainless steel (S2948 to S2957)
- Bergeon 6899M hardened stainless steel (S34415 to S34424)
- Cousins Swiss quality (S35364 to S35373)

Replacement screwdriver blade fixing grub screw:

- Bergeon 30080 (S1480 to S1482)

Code	Description	UOM	Price
S1508	5 Piece (Straight) Bergeon	PACK*5	£38.95

## Bergeon Chromium Plated (9 Pieces, RS)



Bergeon 5970 - Revolving Stand (RS)

- Chromium Plated
- 9 screwdrivers on revolving stand
- Rotating stand Ø90mm
- Very stable base with rubber pad
- Sizes: Ø0.50, 0.60, 0.80, 1.00, 1.20, 1.40, 1.60, 2.00 & 2.50mm
- With spare blades in grey plastic tube
- Bergeon stainless steel blades

Replacement screwdrivers:

- Bergeon 30080 (S1483 to S1495)

Replacement screwdriver blades:

- Bergeon 30080 stainless steel (S2948 to S2957)
- Bergeon 6899M hardened stainless steel (S34415 to S34424)
- Cousins superior quality (S35364 to S35373)

Replacement screwdriver blade fixing grub screw:

- Bergeon 30080 (S1480 to S1482)

Code	Description	UOM	Price
S1505	9 Piece (Straight) Bergeon - Revolving Stand	PACK*9	£84.50

## Bergeon Chromium Plated (10 Pieces, RS)



Bergeon 3044A - Revolving Stand (RS)

- Chromium Plated Screwdrivers
- Rotating stand Ø90mm
- Very stable base on non-slip rubber
- Sizes: Ø0.50, 0.60, 0.80, 1.00, 1.20, 1.40, 1.60, 2.00, 2.50 & 3.00mm
- With spare blades in grey plastic tube
- Bergeon stainless steel blades

Replacement screwdrivers:

- Bergeon 30080 (S1483 to S1496)

Replacement screwdriver blades:

- Bergeon 30080 stainless steel (S2948 to S2957)
- Bergeon 6899M hardened stainless steel (S34415 to S34424)
- Cousins superior quality (S35364 to S35373)

Replacement screwdriver blade fixing grub screw:

- Bergeon 30080 (S1480 to S1482)

Code	Description	UOM	Price
S1506	10 Piece (Straight) Bergeon - Revolving Stand, Deluxe	PACK*10	£189.95

PRICE PROMISE  
GUARANTEE



Cartier's Most Popular Case Back Screws

See Page 154



Arkansas Stones

See Page 1021



**Bergeon Stainless Steel, Dynamometric (10 Pieces, RS)**



Bergeon 7965-S10 - Rotating Stand (RS)

Used with the pre-set torque cylinders, the dynamometric design helps prevent over tightening of the screw, stopping any damage to the thread. When the screw has fully tightened, the drum clicks around without the screwdriver turning. Also available is the "extra grip" drum which provides extra purchase and extra clamping force.

- Special dynamometric knurled handles
- Can be used with or without pre-set torque dynamometric cylinders or extra grip drum
- Dynamometric cylinders are supplied separately
- Extra grip drum is supplied separately
- Dynamometric cylinders or extra grip drum can be used on any size screwdriver
- Cylinders or drum can be positioned anywhere on the screwdriver
- It is possible to mount 2 cylinders, one for total screw control, another for total unscrew control
- Stainless steel
- Conical blade made of hardened stainless steel 54HRC
- Synthetic heads
- Colour coded
- 10 screwdrivers on rotating base
- Sizes: Ø0.50, 0.60, 0.80, 1.00, 1.20, 1.40, 1.60, 2.00, 2.50 & 3.00mm
- With 2 spare blades in each size stored in separate grey plastic tubes
- Bergeon hardened stainless steel blades

Replacement screwdrivers:

- Bergeon 7965 (S40527 to S40536)

Replacement screwdriver blades:

- Bergeon 30080 stainless steel (S2948 to S2957)
- Bergeon 6899M hardened stainless steel (S34415 to S34424)
- Cousins superior quality (S35364 to S35373)

Replacement screwdriver blade fixing grub screws:

- Bergeon 30080 (S1480 to S1482)

Code	Description	UOM	Price
S40481	10 Piece (Straight) Bergeon - Revolving Stand, Knurled, Stainless Steel	PACK*10	£295.00
S40482	"Extra Grip" Drum for Screwdrivers	EACH	£19.95
S48799	9.0 to 11.0mNm Torque Cylinder	EACH	£175.95
S48800	13.7 to 16.3mNm Torque Cylinder	EACH	£175.95
S48801	18.4 to 21.6mNm Torque Cylinder	EACH	£175.95
S48802	23.3 to 26.7mNm Torque Cylinder	EACH	£175.95
S48803	28.2 to 31.8mNm Torque Cylinder	EACH	£175.95
S48804	33.3 to 36.7mNm Torque Cylinder	EACH	£175.95
S48805	38.0 to 42.0mNm Torque Cylinder	EACH	£175.95
S48806	42.8 to 47.2mNm Torque Cylinder	EACH	£175.95
S48807	48.0 to 52.0mNm Torque Cylinder	EACH	£175.95
S48808	52.8 to 57.2mNm Torque Cylinder	EACH	£175.95
S48809	57.6 to 62.4mNm Torque Cylinder	EACH	£175.95

OVER 130,000 DIFFERENT ITEMS

**Bergeon Stainless Steel, Ergonomic (9 Pieces, RS)**



Bergeon 30081.S09 - Ø67mm Revolving Stand (RS)

- 9 Screwdrivers
- Shank & handles:Stainless Steel
- Head of self-lubricating, synthetic POM (Derlin) material
- 1 piece per size spare blade

The new Bergeon "Swiss Made" screwdriver range of tools combine technical quality with comfort of use.

- Blades of hardened stainless steel 54 HRC
- Revolving stand
- Coloured slots for spare blades, 1 piece each size provided
- Sizes: Ø 0.50, 0.60, 0.80, 1.00, 1.20, 1.40, 1.60, 2.00 & 2.50mm

Replacement screwdrivers:

- Bergeon 30081 (S34425 to S34434)

Replacement Screwdriver Blades:

- Bergeon 30080 stainless steel (S2948 to S2957)
- Bergeon 6899M hardened stainless steel (S34415 to S34424)
- Cousins superior quality (S35364 to S35373)

Replacement screwdriver blade fixing grub screw:

- Bergeon 30080 (S1480 to S1482)

Code	Description	UOM	Price
S32171	9 Piece Ø67mm Revolving Stand, Bergeon Stainless Steel	PACK*9	£88.95

**Bergeon Stainless Steel, Ergonomic (10 Pieces, RS)**



Bergeon 30081.S10 - Ø90mm Revolving Stand (RS)

- 10 Screwdrivers
- Shank of anodized aluminium
- Handle of TPE elastomer coat
- Head of self-lubricating, synthetic POM (Derlin) material
- 2 piece per size spare blade

The new Bergeon "Swiss Made" screwdriver range of tools combine technical quality with comfort of use.

- Blades of hardened stainless steel
- Revolving stand
- Coloured slots for spare blades, 1 piece each size provided
- Sizes: Ø 0.50, 0.60, 0.80, 1.00, 1.20, 1.40, 1.60, 2.00, 2.50mm & 3.00mm

Replacement screwdriver blades:

- Bergeon 30080 stainless steel (S2948 to S2957)
- Bergeon 6899M hardened stainless steel (S34415 to S34424)
- Cousins superior quality (S35364 to S35373)

Replacement screwdriver blade fixing grub screws:

- Bergeon 30080 (S1480 to S1482)

Code	Description	UOM	Price
S34435	10 Piece Ø90mm Revolving Stand, Bergeon, Stainless Steel	PACK*10	£169.95

**Bergeon Stainless Steel, Ergonomic (10 Pieces, WC)**



Bergeon 30081.A10 - Wooden Case

- 10 Screwdrivers
- Shank of anodized aluminium
- Handle of TPE elastomer coat
- Head of self-lubricating, synthetic POM (Derlin) material
- 2 piece per size spare blade

The new Bergeon "Swiss Made" screwdriver range of tools combine technical quality with comfort of use.

- Blades of hardened stainless steel
- Wooden case
- Coloured slots for spare blades, 1 piece each size provided
- Sizes: Ø 0.50, 0.60, 0.80, 1.00, 1.20, 1.40, 1.60, 2.00, 2.50mm & 3.00mm

Replacement screwdriver blades:

- Bergeon 30080 stainless steel (S2948 to S2957)
- Bergeon 6899M hardened stainless steel (S34415 to S34424)
- Cousins superior quality (S35364 to S35373)

Replacement screwdriver blade fixing grub screws:

- Bergeon 30080 (S1480 to S1482)

Code	Description	UOM	Price
S38986	10 Piece, Wooden Case, Bergeon, Stainless Steel	PACK*10	£99.95

www. Online Discounts

**Case Holder for Larger Watches**

See Page 1088

**Cousins Stainless Steel (10 Pieces, RS)**



Cousins Swiss Style - Revolving Stand (RS) Stainless Steel

- Deluxe screwdriver set on revolving stand
- Rotating stand Ø90mm
- Non-slip rubber base
- With spare blades in grey plastic tube
- With 10 spare blade fixing screws

Sizes includes:

- Ø0.50mm, Ø0.60mm, Ø0.80mm, Ø1.00mm
- Ø1.20mm, Ø1.40mm, Ø1.60mm, Ø2.00mm
- Ø2.50mm, Ø3.00mm

Replacement Screwdriver Blades

- A\*F Swiss Stainless Steel (S2938 to S2947)
- Bergeon 6899M Hardened Stainless Steel (S34415 to S34424)
- Cousins superior quality (S35364 to S35373)

Replacement Screwdrivers: S33841 to S33850

Code	Description	UOM	Price
S33840	10 Piece (Straight) - Revolving Stand, Deluxe, EU	PACK*10	£59.95

**Cousins Stainless Steel (17 Pieces, WC, includes Crosshead)**



Cousins - Wooden Case (WC)

- 12 flat head screwdrivers: Ø0.50, 0.60, 0.70, 0.80, 1.00, 1.20, 1.40, 1.60, 1.80, 2.00, 2.50 & 3.00mm
- 5 cross head screwdrivers: Ø1.4, 1.60, 2.00, 2.50 & 3.00mm
- 3 Spare blades of each size provided
- Stainless Steel Blades
- Replacement blades: Cousins Swiss quality (S35364 to S35373)
- Supplied in elegant wooden storage and presentation case

Code	Description	UOM	Price
S36657	17 Piece (Straight & Crosshead) - Wooden Case	PACK*17	£74.95

**Cousins Aluminium, Extra Grip (10 Pieces, RS, includes Crosshead)**



Cousins Aluminium - Revolving Stand (RS) - Big Heads - Interchangeable blades

- Revolving stand big head screwdriver set
- 5 big head, big handle screwdrivers with 10 interchangeable blades
- Big handles give extra grip
- Includes crosshead
- Aluminium handles
- Stainless steel blades
- Rotating stand Ø90mm

Blade sizes included:

- Ø0.60mm (White)
- Ø0.80mm (Yellow)
- Ø1.00mm (Black)
- Ø1.20mm (Red)
- Ø1.40mm (Grey)
- Ø1.60mm (Purple)
- Ø1.80mm (Orange)
- Ø2.00mm (Green)
- Crosshead Ø1.40mm (Brown)
- Crosshead Ø1.60mm (Blue)

Replacement Screwdriver Blades:

- Cousins superior quality (S35364 to S35373)

Code	Description	UOM	Price
S40680	5 Piece, 10 Blades (Straight & Cross) Large Handle - Revolving Stand	PACK*5	£84.95

**Horotec Stainless Steel (6 Pieces)**



Horotec Swiss - Stainless Steel

- MSA 01.201.D
- Set of 6 watchmakers' screwdrivers with knurled stainless steel handles.
- Hexagonal swivel large diameter colour coded heads mounted on ball bearings.
- Aluminium solid colour coded stand with 2 steel pillars for quick selection.
- Delivered with 6 replacement hardened stainless steel blades.
- Sizes: Ø0.60, 0.80, 1.00, 1.20, 1.40 & 2.00mm
- Replacement blades: Cousins Swiss quality (S35364 to S35373)

Code	Description	UOM	Price
S31479	6 Piece (Straight) Horotec	PACK*6	£99.95

**Horotec Stainless Steel (12 Pieces, RS)**



Horotec Swiss - Revolving Stand (RS)

- Stainless Steel
- Set of 12 watchmakers' screwdrivers with knurled stainless steel handles.
- Hexagonal Swival large diameter colour coded heads mounted on ball bearings.
- Aluminium solid colour coded stand with 2 steel pillars for quick selection.
- Delivered with 12 replacement hardened steel blades.
- Sizes: Ø0.50, 0.60, 0.70, 0.80, 1.00, 1.20, 1.40, 1.50, 1.60, 2.00, 2.50 & 3.00mm
- Replacement screwdrivers: Codes S42881 to S42892
- Replacement blades: Cousins superior quality (S35364 to S35373)
- Horotec MSA 01.205

Code	Description	UOM	Price
S31478	12 Piece (Straight) Horotec - Revolving Stand, Deluxe	PACK*12	£224.75

**Horotec Stainless Steel, Parallel Blades (10 Pieces)**



- Parallel (curved, T shaped) blades
- Hardened blue steel blades
- Set of 10 watchmaker's screwdrivers with knurled stainless steel handles
- Hexagonal Swival large diameter colour coded heads mounted on ball bearings
- Plastic storage case with protective foam insert
- Delivered with 10 replacement hardened steel blades
- Sizes: Ø0.60, 0.80, 1.00, 1.20, 1.40, 1.60, 1.80, 2.00, 2.50 & 3.00mm
- Replacement screwdrivers: Codes S49213 to S49222
- Replacement blades: Parallel blades (S45935 to S45950)
- Horotec MSA 01.207

Code	Description	UOM	Price
S49212	10 Piece (Parallel) Horotec	PACK*10	£169.95

**Maxell "Mercury Free" Batteries**

See Page 5



**Indian Stainless Steel (5 Pieces, Crosshead)**

**VALUE**



- 5 sizes in plastic wallet
- Sizes: Ø1.50, 2.00, 2.50, 3.00 & 3.50mm
- Fixed blades for extra strength
- Unbeatable value

Code	Description	UOM	Price
S39647	5 Piece (Crosshead) Indian	PACK*5	£3.95

**Indian Stainless Steel (6 Pieces, WC)**

**VALUE**



- 6 sizes in wooden case
- Sizes: Ø1.00, 1.20, 1.40, 1.60, 2.00 & 2.30mm
- Knurled handles
- Screw collet fitting for blades
- Replacement blades: Cousins superior quality (S35364 to S35373)

Code	Description	UOM	Price
S47064	6 Piece (Straight) Indian - Wooden Case	PACK*6	£6.95

**Indian Stainless Steel (7 Pieces)**

**VALUE**



- 7 sizes in plastic wallet
- Sizes: Ø0.60, 0.70, 0.80, 1.00, 1.20, 1.30 & 1.50mm
- Screw collet fitting for blades

- Reversible blades
- Replacement blades: Cousins superior quality (S35364 to S35373)

Code	Description	UOM	Price
S31303	7 Piece (Straight) Indian	PACK*7	£3.95

**Indian Stainless Steel (9 Pieces, Includes Crosshead)**

**VALUE**



Indian Made - Plastic Wallets

- Stainless Steel
- 5 flat head & 4 cross head screwdrivers
- Flat head sizes: Ø1.00, 1.20, 1.40, 1.60 & 2.00mm
- Cross head sizes: Ø1.50, 2.00, 2.50 & 3.00mm
- Screw collet fitting for blades
- Replacement flat blades: Cousins superior quality (S35364 to S35373)

Code	Description	UOM	Price
S41167	9 Piece (Straight & Crosshead)	PACK*9	£5.95

**Indian Stainless Steel (9 Pieces, RS)**

**VALUE**



Indian Made - Revolving Stand (RS) - Great Value

- Value screwdriver set
- 9 screwdrivers on a rotating stand
- Indian stainless steel screwdriver blades
- Sizes: 0.60, 0.80, 1.00, 1.20, 1.40, 1.60, 2.00, 2.50 & 3.00mm
- Spare blades included

Replacement blades: Cousins superior quality (S35364 to S35373)

Code	Description	UOM	Price
S39722	9 Piece (Straight) Indian - Revolving Stand	PACK*9	£9.95

Pegwood

See Page 1187



**Indian Stainless Steel (9 Pieces, RS)**

**VALUE**



Indian Made - Revolving Stand (RS)

- Elegant screwdriver set
- 9 screwdrivers on a rotating stand
- Swiss screwdriver blades
- Sizes: 0.50, 0.60, 0.80, 1.00, 1.20, 1.40, 1.60, 2.00, 2.50mm
- Spare blades included

Replacement screwdrivers: S20258A to S20258I  
Replacement blades: Cousins superior quality (S35364 to S35373)

Code	Description	UOM	Price
S20258	9 Piece (Straight) Indian - Revolving Stand	PACK*9	£18.95

**Indian Stainless Steel (9 Pieces, RS includes Crosshead)**

**VALUE**



Indian Made - Revolving Stand (RS)

- Stainless Steel
- 7 flat head & 2 cross head screwdrivers on revolving stand
- Flat head sizes: Ø0.80, 1.00, 1.20, 1.40, 1.60, 1.80 & 2.00
- Cross head sizes: Ø1.20 & 1.60mm
- Screw collet fitting for blades
- Spare blade of each size provided
- Replacement blades: Cousins superior quality (S35364 to S35373)

Code	Description	UOM	Price
S36071	9 Piece (Straight & Crosshead) Indian - Revolving Stand	PACK*9	£16.95

www. Online Discounts



**Indian Stainless Steel (9 Pieces, WC)**

**VALUE**



- 9 sizes in wooden case
- Sizes: Ø0.60, 0.80, 0.90, 1.00, 1.20, 1.40, 1.60, 2.00 & 2.30mm
- Supplied with 1 spare blade each size
- Handy individual tube storage for spare blades
- Screw collet fitting for blades
- Knurled handles
- Replacement blades: Cousins superior quality (S35364 to S35373)

Code	Description	UOM	Price
S47063	9 Piece (Straight) Indian - Wooden Case	PACK*9	£13.95

**Indian Stainless Steel, Ergonomic (9 Pieces, WC includes Crosshead)**

**VALUE**



- Indian Made - Wooden Case (WC)
- Ergonomic screwdrivers
  - Large, hexagonal heads
  - Supplied in varnished wooden case
  - Stainless Steel
  - 8 flat head & 1 cross head screwdrivers on revolving stand
  - Flat head sizes: Ø0.60, 0.80, 1.00, 1.20, 1.40, 1.60, 1.80 & 2.00
  - Cross head sizes: Ø1.60mm
  - Screw collet fitting for blades
  - Spare blade of each size provided in tube
  - Replacement blades: Cousins stepped blades S47879 to S47887

Code	Description	UOM	Price
S47878	9 Piece (Straight & Cross Head) Indian - Wooden Case	EACH	£17.95

**Indian Stainless Steel, Deluxe (9 Pieces, RS includes Crosshead)**

**VALUE**



- Indian Made - Revolving Stand (RS)
- Deluxe, Swiss style
  - Heavy base with smooth rotation action
  - Rubber ring for comfort and ease of turning
  - Stainless Steel
  - 8 flat head & 1 cross head screwdrivers on revolving stand
  - Flat head sizes: Ø0.60, 0.80, 1.00, 1.20, 1.40, 1.60, 1.80 & 2.00
  - Cross head sizes: Ø1.60mm
  - Screw collet fitting for blades
  - Spare blade of each size provided in colour coded tube
  - Replacement blades: Cousins stepped blades S47879 to S47887

Code	Description	UOM	Price
S47877	9 Piece (Straight & Cross Head) Indian - Revolving Stand	EACH	£32.50

**Mobile Phone Driver Set**

**VALUE**



- 6 pieces cellular phone opener set
- Suitable for electronics, telecommunication and other assembly industries
- Phone models Samsung, Ericsson, Mitubishi, Sony, Panasonic, Samsung/Nokia

Code	Description	UOM	Price
S19732	Mobile Phone Driver Set	PACK*6	£6.95

**Screwdriver Sharpening Tools**

See Page 1000



**Multi Tool, 30 Piece Interchangeable Tips**

**VALUE**



- 30 interchangeable tips
  - Screwdriver handle
  - Includes a set of curved tip tweezers
- Excellent for Repairing retro LCD watches mobile phones, computers, hard drives, printers, Games Consoles, shavers, model, bike, engine, firearms, demolition of small appliances, demolition GB, Wii, Nokia chargers, electric fans, fresh air Philips machine and so on.

- Features:
- Includes set of curved tip tweezers
  - 100mm magnetic screwdriver mounting handle
  - Flat x 5: Ø1.50, 2.00, 2.50, 3.00 & 4.00mm
  - Hexagonal x 6: H1.30, 1.50, 2.00, 2.50, 3.00 & 4.00mm
  - Star (6 point) x 10: T3, 4, 5, 6, 7, 8, 9, 10, 15 & 20
  - Phillips type x 5: 1.70, 2.00, 2.50, 3.00 & 3.50mm
  - Triangle: 3.00
  - Star: 2.00
  - "U" shaped ("concave" type, "fork" type) : U2.6
  - Cylindrical: Ø1.00mm

Weight: 225g

Code	Description	UOM	Price
S35097	Screwdriver Multi-tool	EACH	£6.50

**Multi Tool, 42 Piece Interchangeable Tips**

**VALUE**



- 42 interchangeable tips
  - White nickel plated
  - Screwdriver handle
  - Includes extra long tip holder
  - Includes flexi tip holder
- Excellent for repairing retro LCD watches mobile phones, computers, hard drives, printers, Games consoles, shavers, model, bike, engine, firearms, demolition of small appliances, demolition GB, Wii, Nokia chargers, electric fans, fresh air Philips machines and so on.

- Features:
- Extra long 100mm tip holder & 120mm flexi tip holder for hard to reach jobs
  - 115mm collet screwdriver handle
  - Flat x 7: Ø1.00, 1.50, 2.00, 2.50, 3.00, 3.50 & 4.00mm

**PRICE PROMISE GUARANTEE** ✓

- Hexagonal x 8: H0.90, 1.30, 1.50, 2.00, 2.50, 3.00, 3.50 & 4.00mm
- Star (6 point) x 10: T3, 4, 5, 6, 7, 8, 9, 10, 15 & 20
- Phillips type x 5: 1.00, 1.50, 2.00, 2.50 & 3.50mm
- Triangle type: 2.00
- Inverted "Y" type: 2.00
- "U" shaped ("concave" type, "fork" type): 2.60
- Star (5 point): 1.50
- Cylindrical: Ø1.5mm
- CRV sleeve (bolt fitting) x 7: M2.50, 3.00, 3.50, 4.00, 4.50, 5.00 & 5.50

Weight: 250g

Code	Description	UOM	Price
S36692	42 Tip Screwdriver Multi-tool	PACK*42	£8.95

## SCREWDRIVERS INDIVIDUAL

### A\*F Swiss Stainless Steel (18978A)



Top quality A\*F precision screwdrivers for watchmakers etc.. Handle in chromed brass with colour coded rotating heads mounted on ball bearings, replaceable blades with fixing screws.

Replacements for our all time "Best Selling" Rotating Base Screwdriver Set S1512

- A\*F Swiss
- Brass Hexagonal head
- Replaceable blades
- Sizes: Ø0.50mm to Ø3.00mm

Code	Description	UOM	Price
S1512A	Ø0.50mm (Green) A*F Swiss	EACH	£3.95
S1512B	Ø0.60mm (Pink) A*F Swiss	EACH	£3.95
S1512C	Ø0.80mm (Yellow) A*F Swiss	EACH	£3.95
S1512D	Ø1.00mm (Black) A*F Swiss	EACH	£3.95
S1512E	Ø1.20mm (Red) A*F Swiss	EACH	£3.95
S1512F	Ø1.40mm (Grey) A*F Swiss	EACH	£4.25
S1512G	Ø1.60mm (Violet) A*F Swiss	EACH	£4.25
S1512H	Ø2.00mm (Dark Green) A*F Swiss	EACH	£4.25
S1512I	Ø2.50mm (Blue) A*F Swiss	EACH	£4.25
S1512J	Ø3.00mm (Brown) A*F Swiss	EACH	£4.25

### Bergeon Aluminium, Ergonomic (7899)



- Bergeon 7899 Range
- Ergonomic
- Aluminium

The new screwdriver range's tools combine technical quality and comfort of use.

The screwdrivers are provided with an elastomer membrane which assures an ideal contact between the tool and the hand, while the octagonal head enhances the comfort.

- Shank: Anodized Aluminium
- Handle: TPE elastomer coat.
- Head: Self-lubricating, synthetic POM (Delrin) material.
- Blades: Hardened Stainless Steel.
- Coloured Coded
- Sizes: Ø0.50 - 0.60 - 0.80 - 1.00 - 1.20 - 1.40 - 1.60 - 2.00 - 2.50 - 3.00mm

Replacements for Sets:

- Bergeon 7899.S09 (S32433)
- Bergeon 7899.S10 (S32274)

Replacement Screwdriver Blades (available separately):

- Bergeon 30080 Stainless Steel (S2948 to S2957)
- Bergeon 6899M Hardened Stainless Steel (S34415 to S34424)

Replacement Screwdriver Blade Fixing Grub Screw (available separately):

- Bergeon 30080 (S1480 to S1482)

Code	Description	UOM	Price
S34405	Ø0.50mm (Orange) Bergeon 7899.050	EACH	£8.50
S34406	Ø0.60mm (White) Bergeon 7899.060	EACH	£8.50
S34407	Ø0.80mm (Yellow) Bergeon 7899.080	EACH	£8.50
S34408	Ø1.00mm (Black) Bergeon 7899.100	EACH	£8.50
S34409	Ø1.20mm (Red) Bergeon 7899.120	EACH	£8.50
S34410	Ø1.40mm (Grey) Bergeon 7899.140	EACH	£8.50
S34411	Ø1.60mm (Violet) Bergeon 7899.160	EACH	£8.50
S34412	Ø2.00mm (Green) Bergeon 7899.200	EACH	£8.50
S34413	Ø2.50mm (Blue) Bergeon 7899.250	EACH	£10.95
S34414	Ø3.00mm (Brown) Bergeon 7899.300	EACH	£8.50

### Bergeon Aluminium, Ergonomic & Anti Magnetic (8899)



- 100% Anti Magnetic
- Aluminium handles with TPE elastomer coat
- Ergonomic design

- Premium Quality
- Bergeon 8899 Range
- The Bergeon Swiss 100% anti-magnetic blades are made from a super alloy known as decafor. This material is softer than the hardened stainless steel blades that are supplied with other sets
- Softer blades will not mark the screws or plates

Sizes:

- Ø0.50mm, Ø0.60mm, Ø0.80mm, Ø1.00mm
- Ø1.20mm, Ø1.40mm, Ø1.60mm, Ø2.00mm
- Ø2.50mm, Ø3.00mm

Replacements for Sets:

- Bergeon 8899-A10 (S38992)
- Bergeon 8899-S10 (S39292)

Replacement Screwdriver Blades (available separately):

- Bergeon 4917 (S7997 to S7675)

Replacement Screwdriver Blade Fixing Grub Screw (available separately):

- Bergeon 30080 (S1480 to S1482)

Code	Description	UOM	Price
S38993	Ø0.50mm Antimagnetic Screwdriver	EACH	£9.75
S38994	Ø0.60mm Antimagnetic Screwdriver	EACH	£9.75
S38995	Ø0.80mm Antimagnetic Screwdriver	EACH	£9.75
S38996	Ø1.00mm Antimagnetic Screwdriver	EACH	£9.75
S38997	Ø1.20mm Antimagnetic Screwdriver	EACH	£9.75
S38998	Ø1.40mm Antimagnetic Screwdriver	EACH	£9.75
S38999	Ø1.60mm Antimagnetic Screwdriver	EACH	£9.75
S39000	Ø2.00mm Antimagnetic Screwdriver	EACH	£9.75
S39001	Ø2.50mm Antimagnetic Screwdriver	EACH	£9.75
S39002	Ø3.00mm Antimagnetic Screwdriver	EACH	£9.75

### Bergeon Chromium Plated (30080)



- Bergeon 30080 Range
- First Quality
- Chromium plated, colour coded
- Each screwdriver is supplied with an extra colour coded plastic drum containing spare blades
- Bergeon stainless steel blades

Replacements for Sets:

- Bergeon 2868 (S1508)
- Bergeon 3044A (S1506)
- Bergeon 4063 (S1509)
- Bergeon 5970 (S1505)
- Bergeon 30009 (S1511)

Replacement Screwdriver Blades (available separately):

- Bergeon 30080 Stainless Steel (S2948 to S2957)
- Bergeon 6899M Hardened Stainless Steel (S34415 to S34424)

Replacement Screwdriver Blade Fixing Grub Screws (available separately):

- Bergeon 30080 (S1480 to S1482)

Code	Description	UOM	Price
S1483	Ø0.50mm (Orange) Bergeon 30080B	EACH	£9.95
S1484	Ø0.60mm (White) Bergeon 30080C	EACH	£9.95
S1486	Ø0.80mm (Yellow) Bergeon 30080D	EACH	£9.95
S1488	Ø1.00mm (Black) Bergeon 30080E	EACH	£9.95
S1490	Ø1.20mm (Red) Bergeon 30080F	EACH	£9.95
S1492	Ø1.40mm (Grey) Bergeon 30080G	EACH	£9.95



**Spectacle Screws Assorted**

**See Page 257**



S1493	Ø1.60mm (Violet) Bergeon 30080H	EACH	£9.95
S1494	Ø2.00mm (Green) Bergeon 30080J	EACH	£9.95
S1495	Ø2.50mm (Blue) Bergeon 30080K	EACH	£9.95
S1496	Ø3.00mm (Brown) Bergeon 30080L	EACH	£9.95

## Bergeon Chromium Plated, Additional Diameters (30080)



- Bergeon 30080 Additional Range
- First Quality
- Chromium plated, spare blades in tube included
- Bergeon stainless steel blades

Code	Description	UOM	Price
S1485	Ø0.70mm Bergeon 30080M	EACH	£11.40
S1487	Ø0.90mm Bergeon 30080N	EACH	£11.40
S1489	Ø1.10mm Bergeon 30080O	EACH	£11.40
S1491	Ø1.30mm Bergeon 30080P	EACH	£11.40

## Bergeon Chromium Plated with Drum Barrel (5971)



Ideal for extra purchase & grip for screwing power increase.

For watches submitted to shocks and vibrations, for example automatic watches.

- Bergeon 5971 Range
- First Quality
- Chromium plated, coloured ring
- Bergeon stainless steel blades

Code	Description	UOM	Price
S20556	Ø1.00mm with Drum Barrel	EACH	£13.75
S20557	Ø1.20mm with Drum Barrel	EACH	£13.75
S20559	Ø1.60mm with Drum Barrel	EACH	£13.75

**PRICE PROMISE**  
**GUARANTEE**

## Bergeon Stainless Steel, Dynametric (7965)



- Bergeon 7965 range
- Dynametric knurled handles
- Stainless steel (SS)
- Can be used with or without pre-set torque dynametric cylinders, code S48799 (supplied separately)
- Can be used with or without extra grip drum, code S40482 (supplied separately)

Used with the pre-set torque cylinders, the dynametric design helps prevent over tightening of the screw, stopping any damage to the thread. When the screw has fully tightened, the drum clicks around without the screwdriver turning. Also available is the "extra grip" drum which provides extra purchase and extra clamping force. The cylinders and drum can be used on any size screwdriver in the 7965 range.

- Special dynametric knurled handles
- Can be used with or without pre-set torque dynametric cylinders or extra grip drum
- Dynametric cylinders are supplied separately
- Extra grip drum is supplied separately
- Dynametric cylinders or extra grip drum can be used on any size screwdriver
- Stainless steel
- Conical blade made of hardened stainless steel 54HRC
- Synthetic heads
- Colour coded
- Sizes: Ø0.50, 0.60, 0.80, 1.00, 1.20, 1.40, 1.60, 2.00, 2.50 & 3.00mm
- Cylinders or drum can be positioned anywhere on the screwdriver
- It is possible to mount 2 cylinders, one for total screw control, another for total unscrew control

Replacements for Sets:  
• Bergeon 7965-S10 (S40481)

Replacement Screwdriver Blades (available separately):  
• Bergeon 30080 Stainless Steel (S2948 to S2957)  
• Bergeon 6899M Hardened Stainless Steel (S34415 to S34424)

Replacement Screwdriver Blade Fixing Grub Screw (available separately):  
• Bergeon 30080 (S1480 to S1482)

Code	Description	UOM	Price
S40527	Ø0.50mm (Orange) Bergeon 7965-050	EACH	£18.95
S40528	Ø0.60mm (White) Bergeon 7965-060	EACH	£18.95
S40529	Ø0.80mm (Yellow) Bergeon 7965-080	EACH	£18.95
S40530	Ø1.00mm (Black) Bergeon 7965-080	EACH	£18.95
S40531	Ø1.20mm (Red) Bergeon 7965-120	EACH	£18.95
S40532	Ø1.40mm (Grey) Bergeon 7965-140	EACH	£18.95
S40533	Ø1.60mm (Violet) Bergeon 7965-160	EACH	£18.95
S40534	Ø2.00mm (Green) Bergeon 7965-200	EACH	£18.95
S40535	Ø2.50mm (Blue) Bergeon 7965-250	EACH	£18.95
S40536	Ø3.00mm (Brown) Bergeon 7965-300	EACH	£18.95

## Bergeon Stainless Steel, Ergonomic (30081)



- Bergeon 30081 Range
- Ergonomic
- Stainless Steel (SS)

The new screwdriver range's tools combine technical quality and comfort of use.

- Shank: Stainless steel
- Head: Octagonal self-lubricating, synthetic POM (delrin) material
- Blades: Hardened stainless steel
- Coloured coded
- Sizes: Ø0.50, 0.60, 0.80, 1.00, 1.20, 1.40, 1.60, 2.00, 2.50 & 3.00mm

Replacements for Sets:

- Bergeon 7899.S09 (S32433)
- Bergeon 7899.S10 (S32274)

Replacement Screwdriver Blades (available separately):

- Bergeon 30080 Stainless Steel (S2948 to S2957)
- Bergeon 6899M Hardened Stainless Steel (S34415 to S34424)

Replacement Screwdriver Blade Fixing Grub Screw (available separately):

- Bergeon 30080 (S1480 to S1482)

Code	Description	UOM	Price
S34425	Ø0.50mm (Orange) Ergonomic SS	EACH	£7.50
S34426	Ø0.60mm (White) Ergonomic SS	EACH	£7.50
S34427	Ø0.80mm (Yellow) Ergonomic SS	EACH	£7.50
S34428	Ø1.00mm (Black) Ergonomic SS	EACH	£7.50
S34429	Ø1.20mm (Red) Ergonomic SS	EACH	£7.50
S34430	Ø1.40mm (Grey) Ergonomic SS	EACH	£7.50
S34431	Ø1.60mm (Violet) Ergonomic SS	EACH	£7.50
S34432	Ø2.00mm (Green) Ergonomic SS	EACH	£7.50
S34433	Ø2.50mm (Blue) Ergonomic SS	EACH	£7.50
S34434	Ø3.00mm (Brown) Ergonomic SS	EACH	£7.50

## Bergeon Stainless Steel with Drum Barrel (30081-TAM)



- Bergeon 30081-TAM
- With drum for extra purchase and screwdriver power
- Stainless steel

Ideal for watches that are submitted to shocks & vibrations such as automatic watches

- Shank: Stainless Steel.
- Head: Octagonal self-lubricating, synthetic POM (delrin) material
- Blades: Hardened stainless steel
- Coloured coded
- Sizes: Ø1.00, 1.20, 1.40, 1.60 & 1.80mm

Replacement Screwdriver Blades (available separately):

- Bergeon 30080 Stainless Steel (S2948 to S2957)
- Bergeon 6899M Hardened Stainless Steel (S34415 to S34424)

Replacement Screwdriver Blade Fixing Grub Screw (available separately):

- Bergeon 30080 (S1480 to S1482)

Code	Description	UOM	Price
S48651	Ø1.00mm with Drum Barrel	EACH	£13.75
S48652	Ø1.20mm with Drum Barrel	EACH	£13.75
S48653	Ø1.40mm with Drum Barrel	EACH	£13.75
S48654	Ø1.60mm with Drum Barrel	EACH	£13.75
S48655	Ø1.80mm with Drum Barrel	EACH	£13.75

**Cousins - Steel, Economy**



In white metal with hexagonal swivel head, tempered steel, fixed blade.

- All metal
- Swivel Hexagonal heads

Code	Description	UOM	Price
S9230A	Ø0.45mm Economy	EACH	£0.95
S9230B	Ø0.60mm Economy	EACH	£0.95
S9230C	Ø0.80mm Economy	EACH	£0.95
S9230D	Ø0.90mm Economy	EACH	£0.95
S9230E	Ø1.00mm Economy	EACH	£0.95
S9230F	Ø1.20mm Economy	EACH	£0.95
S9230G	Ø1.40mm Economy	EACH	£0.95
S9230H	Ø1.80mm Economy	EACH	£0.95
S9230I	Ø2.00mm Economy	EACH	£0.95
S9230J	Ø2.30mm Economy	EACH	£0.95

**Cousins - Steel, Economy, Swiss Style**



Economic screwdrivers with rotating head and colour coding rings for easy diameter identification. Body in

chromed brass with replaceable hardened steel Swiss blades.

- Supplied with Swiss Blade
- Replacement Screwdriver for Set S20258

Code	Description	UOM	Price
S20258A	Ø0.50mm Swiss Style	EACH	£2.15
S20258B	Ø0.60mm Swiss Style	EACH	£2.15
S20258C	Ø0.80mm Swiss Style	EACH	£2.15
S20258D	Ø1.00mm Swiss Style	EACH	£2.15
S20258E	Ø1.20mm Swiss Style	EACH	£2.15
S20258F	Ø1.40mm Swiss Style	EACH	£2.15
S20258G	Ø1.60mm Swiss Style	EACH	£2.15
S20258H	Ø2.00mm Swiss Style	EACH	£2.15
S20258I	Ø2.50mm Swiss Style	EACH	£2.15

**Cousins - Steel, Economy, Swiss Style Precision**



Precision economic screwdrivers with rotating head and colour coding rings for easy diameter identification. Body in chromed brass with replaceable hardened steel Swiss blades. These screwdrivers are suitable to use on the fine delicate & precious articles such as watches, jewellery, high technology instruments and aviation electronic apparatus etc.

- Supplied with Swiss Blade
- Replacement Screwdriver for Set S33840

Code	Description	UOM	Price
S33841	Ø0.50mm Swiss Style Precision	EACH	£4.40
S33842	Ø0.60mm Swiss Style Precision	EACH	£4.40
S33843	Ø0.80mm Swiss Style Precision	EACH	£4.40
S33844	Ø1.00mm Swiss Style Precision	EACH	£4.40
S33845	Ø1.20mm Swiss Style Precision	EACH	£4.40
S33846	Ø1.40mm Swiss Style Precision	EACH	£4.40
S33847	Ø1.60mm Swiss Style Precision	EACH	£4.40
S33848	Ø2.00mm Swiss Style Precision	EACH	£4.40
S33849	Ø2.50mm Swiss Style Precision	EACH	£4.40
S33850	Ø3.00mm Swiss Style Precision	EACH	£4.40

**Cousins - Steel, Extra Grip**



- 5 interchangeable blades
- Extra thick, Ø14mm handle and grip
- Knurled handle
- Ideal for extra purchase for screwing power increase
- For watches submitted to shocks and vibrations, for example automatic watches
- Replacement blades available
- Made in E.U

Blade sizes:  
 • Ø1.00mm  
 • Ø1.20mm  
 • Ø1.40mm

- Ø1.60mm
- Ø1.80mm

Code	Description	UOM	Price
S37434	Screwdriver, Extra Grip	EACH	£22.25
S41954	Screwdriver Blade Set	PACK*4	£12.95

**Cousins - Steel, Extra Grip (with Crosshead)**



- 4 interchangeable blades
- Ø10mm thick handle and grip
- Knurled handle
- Ideal for extra purchase for screwing power increase
- For watches submitted to shocks and vibrations, for example automatic watches
- Blades stored in base
- Made in Inida

Blade sizes:

- Flat, Ø1.60mm x 2
- Crosshead, Ø3.00mm
- Pin, Ø0.80mm

Code	Description	UOM	Price
S39648	Screwdriver, Extra Grip (with Crosshead)	EACH	£2.95

**Cousins - Steel, Extra Grip (with Crosshead)**



- Crosshead & Straight Reversible Blade
- Ø12mm thick grip with rubber grips
- Ideal for extra purchase for screwing power increase
- Rotating head for ease of use
- For watches submitted to shocks and vibrations, for example automatic watches
- Made in Inida

Blade sizes:

- Flat, Ø1.50mm
- Crosshead, Ø2.00mm

Code	Description	UOM	Price
S46141	Screwdriver, Extra Grip (with Crosshead)	EACH	£1.85
S46142	Flat & Cross Head Reversible Screwdriver Blade	EACH	£0.75

**Ridged Bench Mats**

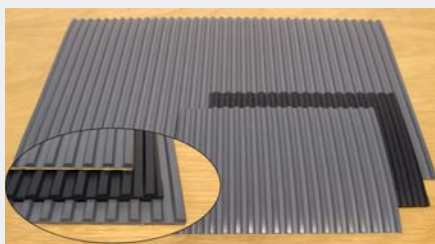

Ref: M31429 See Page: 923

**Cousins - Torx (6 Point Star)**



Cousins range of precision Mini Tork Screwdrivers, professional quality

- With ergonomic soft grip rotating handles they are a perfect combination of great grip plus reducing fatigue.
- Precision screwdrivers made of special high-alloy steel
- Marked with sizes easy to pick the right screwdriver
- Available in various sizes
- Light weighted and blackened ends enable fast accurate usage.
- Diameter in mm is Point to Point

Code	Description	UOM	Price
S34256	T5 (Ø1.42mm) Tork Screwdriver	EACH	£1.85
S34257	T6 (Ø1.70mm) Tork Screwdriver	EACH	£1.85
S34258	T7 (Ø1.99mm) Tork Screwdriver	EACH	£1.85
S34259	T8 (Ø2.31mm) Tork Screwdriver	EACH	£1.85
S34260	T9 (Ø2.50mm) Tork Screwdriver	EACH	£1.85
S34261	T10 (Ø2.74mm) Tork Screwdriver	EACH	£1.85

**Cousins - Torx (6 Point Star) Swivel Head**



Cousins range of precision Mini Tork Screwdrivers, professional quality

- With ergonomic soft grip rotating handles they are a perfect combination of great grip plus reducing fatigue.
- Precision screwdrivers made of special high-alloy steel
- Marked with sizes easy to pick the right screwdriver
- Available in various sizes
- Light weighted and blackened ends enable fast accurate usage.
- Diameter in mm is Point to Point

Code	Description	UOM	Price
S34262	T5 (Ø1.42mm) Tork Screwdriver	EACH	£1.65
S34263	T6 (Ø1.70mm) Tork Screwdriver	EACH	£1.65
S34264	T7 (Ø1.99mm) Tork Screwdriver	EACH	£1.65
S34265	T8 (Ø2.31mm) Tork Screwdriver	EACH	£1.65
S34266	T9 (Ø2.50mm) Tork Screwdriver	EACH	£1.65
S34267	T10 (Ø2.74mm) Tork Screwdriver	EACH	£1.65

**Horotec Stainless Steel**



Horotec Swiss - Stainless Steel

- Knurled stainless steel handle
- Large hexagonal swivel head
- Hardened blue steel blades
- Sizes: Ø0.50, 0.60, 0.70, 0.80, 0.90, 1.00, 1.10, 1.20, 1.40, 1.50, 1.60, 1.80, 2.00, 2.50, 3.00 & 3.50mm
- Replacement blades: Cousins superior quality (S35364 to S35373) (available separately)
- Replacements for set S31478
- Horotec Swiss MSA 01.201-XX

Code	Description	UOM	Price
S42881	Ø0.50mm (Orange) Screwdriver	EACH	£9.15
S42882	Ø0.60mm (Aluminium) Screwdriver	EACH	£9.15
S42883	Ø0.70mm (Pastel Yellow) Screwdriver	EACH	£11.95
S42884	Ø0.80mm (Yellow) Screwdriver	EACH	£9.15
S48546	Ø0.90mm (Pink) Screwdriver	EACH	£8.75
S42885	Ø1.00mm (Black) Screwdriver	EACH	£9.15
S48547	Ø1.10mm (Light Blue) Screwdriver	EACH	£11.95
S42886	Ø1.20mm (Red) Screwdriver	EACH	£9.15
S48548	Ø1.30mm (Light Green) Screwdriver	EACH	£11.95
S42887	Ø1.40mm (Dark Grey) Screwdriver	EACH	£9.15
S42888	Ø1.50mm (Salmon) Screwdriver	EACH	£11.95
S42889	Ø1.60mm (Violet) Screwdriver	EACH	£9.15
S48549	Ø1.80mm (Light Grey) Screwdriver	EACH	£11.95
S42890	Ø2.00mm (Dark Green) Screwdriver	EACH	£9.15
S42891	Ø2.50mm (Blue) Screwdriver	EACH	£9.15
S42892	Ø3.00mm (Brown) Screwdriver	EACH	£9.15
S48550	Ø3.50mm (Orange) Screwdriver	EACH	£11.95

**Horotec Stainless Steel, Parallel Blades**



- Parallel (curved, T shaped) blades
- Hardened blue steel blades
- Knurled stainless steel handle
- Large hexagonal swivel head
- Sizes: Ø0.60, 0.80, 1.00, 1.20, 1.40, 1.60, 1.80, 2.00, 2.50 & 3.00mm
- Replacement blades: Parallel (S45935 to S45950) (available separately)
- Replacements for set S49212
- Horotec Swiss MSA 01.207-XX

Code	Description	UOM	Price
S49213	Ø0.60mm (Light Grey) Screwdriver	EACH	£13.95
S49214	Ø0.80mm (Yellow) Screwdriver	EACH	£13.95
S49215	Ø1.00mm (Black) Screwdriver	EACH	£13.95
S49216	Ø1.20mm (Red) Screwdriver	EACH	£13.95
S49217	Ø1.40mm (Dark Grey) Screwdriver	EACH	£13.95

S49218	Ø1.60mm (Violet) Screwdriver	EACH	£14.95
S49219	Ø1.80mm (Grey) Screwdriver	EACH	£14.95
S49220	Ø2.00mm (Dark Green) Screwdriver	EACH	£14.95
S49221	Ø2.50mm (Blue) Screwdriver	EACH	£14.95
S49222	Ø3.00mm (Brown) Screwdriver	EACH	£14.95

**Crosshead (Stainless Steel), A\*F Swiss**



Individual A\*F Philips screwdrivers with cross-point blade tips. Allow fast dismantling of modules assembled and assembly with Philips (cross head) screws.

- A\*F Swiss
- Crosshead
- Colour coded

Sizes:

- Ø1.20mm
- Ø1.50mm
- Ø2.00mm
- Ø2.50mm
- Ø3.00mm

Code	Description	UOM	Price
S40289	Ø1.20mm (Grey) A*F Swiss	EACH	£5.25
S19513	Ø1.50mm (Purple) A*F Swiss	EACH	£5.25
S19514	Ø2.00mm (Green) A*F Swiss	EACH	£5.25
S19515	Ø2.50mm (Blue) A*F Swiss	EACH	£5.25
S19516	Ø3.00mm (Brown) A*F Swiss	EACH	£5.25

**Crosshead (Steel), Cousins**



Individual Cousins Euro Swiss style crosshead (Philips) screwdrivers with cross-point blade tips. Allow fast dismantling and assembly of modules assembled with Philips (cross head) screws.

- Cross head
- Good quality
- Made in E.U

Sizes available:

- Ø1.40mm
- Ø1.60mm
- Ø2.00mm
- Ø2.50mm
- Ø3.00mm

Replacement screwdriver blades:

• S36677 to S36681

Code	Description	UOM	Price
S36672	Ø1.40mm Screwdriver Cross Head, Cousins	EACH	£3.75
S36673	Ø1.60mm Screwdriver Cross Head, Cousins	EACH	£3.75
S36674	Ø2.00mm Screwdriver Cross Head, Cousins	EACH	£3.75
S36675	Ø2.50mm Screwdriver Cross Head, Cousins	EACH	£3.75
S36676	Ø3.00mm Screwdriver Cross Head, Cousins	EACH	£3.75

**Crosshead (Steel), Cousins, Tradesmen**



Tradesmen - Crosshead

Cousins range of precision cross head screwdrivers, professional quality

- With ergonomic soft grip rotating handles they are a perfect combination of great grip plus reducing fatigue.
- Precision screwdrivers made of special high-alloy steel
- Marked with sizes easy to pick the right screwdriver
- Available in various lengths and sizes
- Light weight with blackened ends enable fast accurate usage

Dimensions:

- Screw Head Diameter x Reach

Code	Description	UOM	Price
S33911	Ø2.0mm x 50mm Tradesmen	EACH	£1.85
S33912	Ø2.4mm x 50mm Tradesmen	EACH	£1.85
S33913	Ø3.0mm x 50mm Tradesmen	EACH	£1.85
S33915	Ø3.0mm x 75mm Tradesmen	EACH	£1.85
S33914	Ø4.0mm x 50mm Tradesmen	EACH	£1.85
S33916	Ø4.0mm x 100mm Tradesmen	EACH	£1.85
S34255	Ø4.0mm x 150mm Tradesmen	EACH	£1.85

**Demagnetisers**



Ref: D0415  
See Page: 657

**Crosshead (Steel), Value**



Individual economy Philips screwdrivers with cross-point blade tips. Allow fast dismantling of modules assembled and assembly with Philips (cross head) screws.

- Cross head
- Good quality
- Made in Taiwan

Sizes available:

- Ø1.40mm
- Ø1.60mm
- Ø2.00mm
- Ø2.40mm
- Ø3.00mm
- Ø3.80mm

Code	Description	UOM	Price
S34268	Ø1.40mm Cross Head Screwdriver	EACH	£0.95
S34269	Ø1.60mm Cross Head Screwdriver	EACH	£0.95
S34270	Ø2.00mm Cross Head Screwdriver	EACH	£0.95
S34271	Ø2.40mm Cross Head Screwdriver	EACH	£0.95
S34272	Ø3.00mm Cross Head Screwdriver	EACH	£0.95
S34273	Ø3.80mm Cross Head Screwdriver	EACH	£0.95

**SCREWDRIVERS BY BRAND**

**Audemars Piguet**



- For Audemars Piguet nuts
- 4 prong blades
- Ladies (2.25mm square blade) & gents (2.75mm square blade)
- Lightweight aluminium handle
- Rotating head
- Overall length 110mm
- CousinsUK Swiss style

Code	Description	UOM	Price
S47907	Gents Audemars Piguet Screwdriver, CousinsUK Swiss Style	EACH	£22.95
S47908	Ladies Audemars Piguet Screwdriver, CousinsUK Swiss Style	EACH	£22.95



**Hublot (Bezel Screw)**



- For Hublot bezel screws
- Notched blade
- 2.35 x 0.50mm (blade width x notch width)
- Lightweight aluminium handle
- Rotating head
- Overall length 110mm
- CousinsUK Swiss style

Code	Description	UOM	Price
S47909	Hublot Bezel Screwdriver, CousinsUK Swiss Style	EACH	£22.95

**Hublot (Bezel Screw)**



Screwdriver - H Type - For Hublot Watches

Economy version, easily damaged when used on tight screws.

- H type blade
- Specifically for Hublot bezel screws watches
- Stainless Steel
- Great value

Code	Description	UOM	Price
S41170	H Type Blade for Hublot Screwdriver	EACH	£1.95

**Richard Mille (Bracelet)**



- For Richard Mille bracelets
- 4 prong screwdriver
- 2.35mm square blade
- Lightweight aluminium handle
- Rotating head
- Overall length 110mm
- CousinsUK Swiss style

Code	Description	UOM	Price
S47911	Richard Mille Bracelet Screwdriver, Cousins Swiss Style	EACH	£22.95

**Richard Mille (Case & Movement)**



- For Richard Mille cases and movements
- 5 prong blade
- Ø2.30mm blade
- Lightweight aluminium handle
- Rotating head
- Overall length 110mm
- CousinsUK Swiss style

Code	Description	UOM	Price
S47910	Richard Mille Case & Movement Screwdriver, CousinsUK Swiss Style	EACH	£22.95

## Seiko (Crosshead), A\*F Swiss



Screwdriver - Crosshead - Needed for Calibre Seiko 7S26

- A\*F Swiss
- Specifically for Seiko calibre 7S26
- Ø0.98mm blade
- Crosshead
- Stainless Steel

Code	Description	UOM	Price
S40290	Ø0.98mm Seiko Screwdriver, A*F Swiss	EACH	£8.95

## Seiko (Crosshead), Seiko S-921



Screwdriver - Crosshead

- Seiko brand screwdriver
- Seiko S-921
- Ø1.20mm blade
- Crosshead
- Knurled handle
- Swivel hexagonal head
- Stainless Steel
- Made in Japan

Code	Description	UOM	Price
S49223	Seiko S-921 Screwdriver	EACH	£9.95

## Skagen



Screwdriver - For Skagen Watches

- 4 point cross blade
- Specifically for Skagen watch bracelets
- Stainless Steel
- Great value

Code	Description	UOM	Price
S45549	Screwdriver for Skagen	EACH	£1.50

## SCREWDRIVER SHARPENERS

Roller type screwdriver sharpeners are handy little tools to keep your screwdriver blades sharp to a precision edge.

- Just place your blade/screwdriver in the holder, slide up and down your sharpening stone and achieve the perfect edge
- We have a full range of sharpening stones for fast and efficient cutting/finishing (see links below)

## Screwdriver Sharpener Tool, Horotec

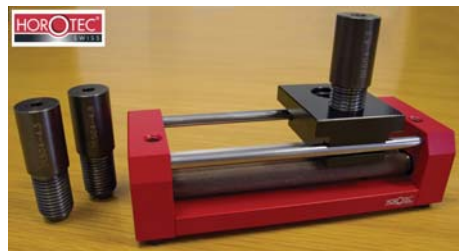

Screwdriver Sharpener - Horotec Swiss - New Version Sharpener

- New version Horotec screwdriver sharpener
- The screwdriver is now held by the body, not by the blade, providing extra stability and protection
- 3 sizes of screwdriver holders, takes screwdrivers with body sizes Ø4.30, 4.80 & 5.30mm
- 2 round and 1 square sharpening stones
- 4 vulcanized rubber feet
- Swiss made
- Horotec 01.504

Dimensions:

- 130 x 50 x 45mm
- 530g

See PDF for full instructions

Code	Description	UOM	Price
S44239	Screwdriver Sharpener, Horotec Swiss	EACH	£175.00
S47761	Round Stone for Screwdriver Sharpener	EACH	£49.95
S47762	Square Stone for Screwdriver Sharpener	EACH	£19.95

## A\*F Swiss Screwdriver Sharpener with Stone

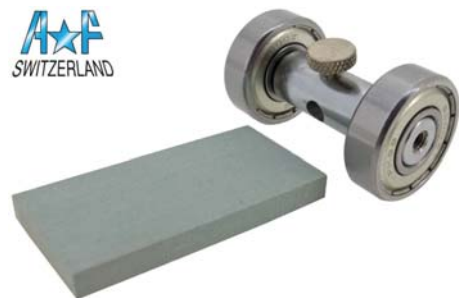

A\*F Swiss

To keep your screwdriver blades sharp to a precision edge. Sharpening stone included.

- Grips screwdrivers firmly
- Smooth rolling action
- Can hold screwdrivers with body up to Ø5.10mm

Code	Description	UOM	Price
S47108	Screwdriver Sharpener with Stone	EACH	£18.50

## A\*F Swiss Screwdriver Sharpener



- A\*F 170.500
- Can hold screwdrivers with body up to Ø5.10mm

Code	Description	UOM	Price
S7676	A*F Swiss Screwdriver Sharpener	EACH	£18.65

## Bergeon Screwdriver Sharpener



- Bergeon 2461
- Can hold screwdrivers with body up to Ø6.95mm

Code	Description	UOM	Price
S1521	Bergeon Screwdriver Sharpener	EACH	£22.95

## Non Swiss Screwdriver Sharpener

VALUE



- Can hold screwdrivers with body up to Ø5.50mm
- Width 43mm (outside of wheels)
- Non Swiss

Code	Description	UOM	Price
S31322	Non Swiss Screwdriver Sharpener	EACH	£3.30

## SHOVELS, SCOOPS & PAPERWEIGHTS

### Diamond Paperweight



Diamond Paperweight

- Keeps stones & paper secure when displaying
- 4 pivot joints giving maximum flexibility
- Folds away for easy transportation
- Maximum opening: 100 x 100 x 75 x 75mm
- Weight: 45g

Code	Description	UOM	Price
W39599	Diamond Paperweight	EACH	£2.85

### Diamond Shovel with Handle



- For diamond and precious stones etc.
- With chrome finished handle
- 55mm x 40mm

Code	Description	UOM	Price
D6237	Diamond Shovel with Handle	EACH	£1.95



SECURE ONLINE ORDERING

PRICE PROMISE GUARANTEE

**Diamond Shovel without Handle**



- For diamond and precious stones etc.
- Without handle, chrome finished

Dimensions:

- Width x length

Code	Description	UOM	Price
D6238	40 x 55mm Shovel	EACH	£0.70
S48812	95 x 130mm Shovel	EACH	£1.50

Price breaks available, see website

**Scoop, Plastic**



- White plastic scoop
- 150mm
- Weight 20gms
- Ideal for large sized beads

Code	Description	UOM	Price
S19164	Plastic Scoop	EACH	£1.35

**SOLDERING, MELTING AND CASTING**

**BORAX DISHES**

**Borax Dishes**

Borax Dishes are used with borax cones and are a traditional way of making your own flux for precious/non precious soldering.

Pour a little water into your borax dish the residual water should be enough to form a paste. Grind down the cone on bottom of the dish using a round motion this will result a soldering flux paste to be formed. If your left with some flux don't worry just add water and repeat the process to make more flux.

- Tray or dishes available
- Glazed or non glazed
- A\*F Swiss or value

Diameter x depth (if given)

**Diamond Wrapping Papers**

See Page 1187

**Ø75mm Borax Tray, Non-Glazed**



Code	Description	UOM	Price
T39344	Ø75mm Borax Tray, Non-Glazed	EACH	£0.95

**Ø100mm Borax Tray, Non-Glazed**



Code	Description	UOM	Price
B31893	Ø100mm Borax Tray, Non-Glazed	EACH	£1.95

**Ø100 x 15mm Borax Dish, Non Glazed**



Code	Description	UOM	Price
B42900	Ø100 x 15mm Borax Dish, Non Glazed	EACH	£2.95

**Ø120 x 30mm Borax Dish, Glazed, A\*F Swiss**



In stone, for preparing flux paste from Borax cones.

Code	Description	UOM	Price
B0133	Ø120 x 30mm Borax Dish, Glazed, A*F Swiss	EACH	£15.20

**CASTING FLASKS, BASES & SPRUE MANDRELS**

**Casting Flasks**



- Casting flask
- Wall thickness 3mm (10 SWG gauge)
- Designed to withstand shocks whilst casting
- Used in vacuum casting or centrifugal casting
- Stainless steel

Dimensions:

- Diameter x Height

Code	Description	UOM	Price
F45732	Ø45 x 45mm Casting Flask	EACH	£2.95
F45733	Ø50 x 45mm Casting Flask	EACH	£3.50
F45734	Ø65 x 65mm Casting Flask	EACH	£4.95
F45737	Ø80 x 80mm Casting Flask	EACH	£6.95
F45738	Ø80 x 100mm Casting Flask	EACH	£6.50
F45736	Ø90 x 65mm Casting Flask	EACH	£5.95
F45739	Ø90 x 125mm Casting Flask	EACH	£7.95
F45740	Ø100 x 100mm Casting Flask	EACH	£8.25
F45741	Ø100 x 120mm Casting Flask	EACH	£8.50
F45742	Ø100 x 150mm Casting Flask	EACH	£8.95

**Casting Flasks (Perforated)**

- Perforated casting flasks
- Wall thickness 3mm (10 SWG gauge)
- Cross bar on top to prevent warping
- Perforated flasks are used in chamber style vacuum casting machines
- The holes on the sides help insure a more perfect cast since the molten metal is being forced into cavities from all directions
- Stainless steel



Dimensions:

- Diameter x Height

Code	Description	UOM	Price
F45729	Ø100 x 150mm Perforated Casting Flask	EACH	£27.95
F45730	Ø100 x 180mm Perforated Casting Flask	EACH	£29.95
F45731	Ø100 x 200mm Perforated Casting Flask	EACH	£31.95





## Casting Flasks (Sand Casting)



- Traditional sand casting flask
- Vertical & horizontal filling
- Held securely by two locating pins
- 125 x 85 x 55mm
- Weight 1.25kg

Code	Description	UOM	Price
C39328	Sand Casting Flask	EACH	£8.95

## Silicon Ring Gaskets



- Silicon casting rings
- Used with a perforated casting flask to seal the flask to the vacuum chamber
- 4mm thick silicone

Dimensions:  
• Inner diameter x outer diameter

Code	Description	UOM	Price
C47335	Ø75 x Ø100mm Casting Silicon Ring	EACH	£1.05
C47336	Ø90 x Ø115mm Casting Silicon Ring	EACH	£1.20
C47337	Ø100 x Ø120mm Casting Silicon Ring	EACH	£1.30

## Sprue Bases



- Rubber sprue base
- Tree type
- Heavy duty rubber
- Allows casting flasks to be held in place, forming a leak proof seal
- Melt wax into the center hole and then either add a sprue or attach wax models right to the dome base
- Tree sprue base are perfect for high production jewelry making studios
- 25mm high
- Dimensions given is the outer base diameter

Code	Description	UOM	Price
F45724	Ø50mm Sprue Base	EACH	£1.25
F45725	Ø65mm Sprue Base	EACH	£1.35
F45726	Ø75mm Sprue Base	EACH	£1.45
F45727	Ø90mm Sprue Base	EACH	£1.55
F45728	Ø100mm Sprue Base	EACH	£1.65

## Sprue Burning Mandrel



### Sprue Burning Mandrel

Heat this over a burner and you can then insert into your moulds, creating your sprue. Eliminates the need for a sprue forming mandrel.

- Stainless steel
- Wooden handle
- Max cone diameter Ø15mm
- Overall length 205mm

Code	Description	UOM	Price
M39346	Sprue Burning Mandrel	EACH	£2.50

## Sprue Forming Mandrel

### Sprue Forming Mandrel

- Form the passage that your liquid material will pass through with ease (your sprue)
- Made from Brass
- Overall length 50mm
- Max diameter Ø14mm
- Ø2.95mm shank



Code	Description	UOM	Price
M39345	Sprue Forming Mandrel	EACH	£1.20

## CLAY CASTING, DELFT



*Invented for the precision needs of manufacturing jewellers, clock and watch makers.*

*The Delft Clay Method of Casting is a form of sand casting. It makes it possible to make remarkably sharp castings of many objects in gold, silver and other metals.*

*After casting, the Delft clay can be re-used immediately.*

*The Delft Clay Method of Casting has been developed for jewellers, clock and watchmakers. It is also put into practice in model making.*

*As a model one can use an existing piece of jewellery, clock and watch or a model made of hard material, like plastic, hard wax, wood, metal, stone, etc.*

*The Delft Clay Method of Casting is an idea by Hans Karreman, a goldsmith from Delft. Since the eighties, Hans Karreman has been experimenting with mouldable clay.*

*After several years the Delft Clay Method of Casting originated from this. This method makes it possible to cast jewellery and object in gold, silver and other metals.*

## Delft Clay Casting



### Kit includes:

- 2 kg Delft Clay
- Set of 60mm Aluminium Rings
- Instructional DVD
- Users Manual

The Delft Clay Method of Casting became more widely known when the pupils of Hans Karreman started using the method and colleagues became interested in this finding. Gradually the demand for the Delft Clay Method of Casting increased.

The Delft Clay Method of Casting consists of a mould and mouldable Delft clay, in which objects can be cast remarkably sharp and fast.

The Delft Clay is reusable and cannot dry out due to its special composition. For designing his jewellery clock and watch parts, the Delft Clay method of casting started to play a more and more important role. It enabled him to make castings of the basic forms for his designs. Also for restoration of jewellery and objects, the Delft Clay method of casting becomes more important.

Many jewellery and objects, which used to be cast by a professional casting company, he could now cast in his own atelier.

### Clock Parts:

Brass acorns, balls, rosette/patera, Garland case ornaments, clock case ornaments, escutcheons, clock feet, finals, door pulls, door handles, hinges, fugit plaques, spandrel clock case corners, regulator top crowns, cuckoo clock top crowns, pendulums weights, plaques, number clock.

Watch Parts: cases, bezels, bracelet links, buckles, pocket watch decorations, pocket watch case parts.

### Jewellery:

Rings, bracelets, ear rings, jewellery bracelet links, clasp parts, chain links, mounts, pendants, lockets, badges, toe rings, bangles, medals, plaques.

Antique Furniture: door pulls, decorative handles, corner decorations etc.

Code	Description	UOM	Price
K30616	Delft Clay Standard Kit	EACH	£49.95
C30617	Delft Clay	2KG	£24.95
R30618	Delft Clay Set of 60mm Rings	EACH	£22.95
R30619	Delft Clay Set of 100mm Rings	EACH	£29.95

**PRICE PROMISE  
GUARANTEE**



## Borax Flux Cone

See Page 1195



## CRUCIBLE HOLDERS & TONGS

Large range of traditional and new crucible holders and tongs.

- Pick up and place your pieces, crucibles or flasks with confidence around your work shop
- Ideal for acid baths (pickling), precious and non precious smelting
- Selection available for soldering aids for large pieces of work
- Available in various finishes and lengths

### Crucible Holders (Round or Square)

- Popular usage with The Delft Casting System (code K30616)
- Easy pick up and pour into your ingots/ casting sand while melting
- Wooden handle fitted for heat hand protection
- Large range of flat & shoe crucibles

### Crucible Holder, Belgian



- Popular usage with The Delft Casting System (code K30616)
- Easy pick up and pour into your ingots/ casting sand while melting
- Wooden handle fitted for heat hand protection
- Overall length 350mm
- See our listing for full range of flat/shoe type crucibles code C0408, C32195, and c312199
- Weight 190 grams

How to use:

1. Place the crucible of your choice at the end of the raised two prongs
2. Push up to crucible the slide with locking hand nut
3. For extra securing tap gently with a Mallet (M4750) thus pushing the locking slide tighter and you are ready to melt your metal.
4. If a shoe crucible is used place the spring over the top this will give more safeguarding while melting/ pouring

Code	Description	UOM	Price
H30620	Crucible Holder, Belgian	EACH	£16.95

### Crucible Holder, Indian

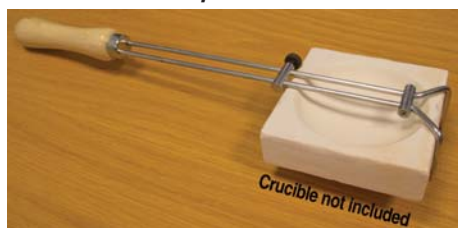

- End prongs width 80mm
- Overall length 380mm

Code	Description	UOM	Price
T37827	Crucible Holder, Indian	EACH	£5.95

### Crucible Holder, Indian (Superior)



- End prongs width 40mm
- Overall length 370mm
- Belgian design

Code	Description	UOM	Price
C45718	Crucible Holder, Indian (Superior)	EACH	£7.50

### Crucible Flask Holders

#### Flask Holder up to Ø80mm



- Max capacity Ø80mm
- Min capacity Ø70mm
- Overall length 460mm
- Wooden handle, length 135mm
- Easy & solid wing nut fixing
- Stainless steel

Code	Description	UOM	Price
T39330	Flask Holder up to Ø80mm	EACH	£5.95

#### Flask Tongs, Length 390mm



- Length 390mm
- Stainless Steel
- Flask type
- 15mm height ends

Code	Description	UOM	Price
T39332	Flask Tongs, Length 390mm	EACH	£4.95

#### Flask Tongs, Length 390mm (Double Ended)



- Length 390mm
- Stainless Steel
- Flask type
- Double ended
- 15mm height ends

Code	Description	UOM	Price
T39333	Flask Tongs, Length 390mm (Double Ended)	EACH	£6.95

#### Flask Tongs, Length 400mm



- Length 400mm
- Double ended
- Thick ends, 30mm & 40mm Heights

- Stainless Steel

Code	Description	UOM	Price
T34915	Flask Tongs, Length 400mm	EACH	£6.95

### Crucible Flask Holders with Groove

Universal tongs for grooved solid graphite crucibles for electric furnaces

- Pick up crucible flasks with confidence around your work shop
- Available in various finishes and lengths

#### Grooved Flask Tongs, Length 350mm



Universal tongs for grooved solid graphite crucibles for electric furnaces

- Plier Grip
- Insulated Handles
- Length 350mm

Code	Description	UOM	Price
T34948	Grooved Flask Tongs, Length 350mm	EACH	£4.95

#### Grooved Flask Tongs, Length 400mm



- Grooved Flask tongs
- Wooden handles
- Stainless steel arms
- Overall length 400mm

Code	Description	UOM	Price
T46146	Grooved Flask Tongs, Length 400mm	EACH	£8.95

### Crucible Lift Out Tongs

#### Lift Out Tongs, Length 480mm (Stainless Steel)



- Universal casting/smelting tongs
- Lift out tongs
- Recommended to hold and pick up our selection of crucibles and pots (smaller sizes)
- Made in stainless steel
- Bent nose tips
- Length 480mm
- Fully opens to 100mm

Code	Description	UOM	Price
T42897	Lift Out Tongs, Length 480mm (Stainless Steel)	EACH	£7.95

#### Lift Out Tongs, Length 500mm



- Universal casting/smelting tongs blackened finish
- Lift out tongs

- Recommended to hold and pick up our selection of crucibles and pots (smaller sizes)
- Made in steel
- Plastic coated insulation handles
- Bent nose tips
- Length 500mm
- Fully opens to 80mm
- Weight 350 grams

Code	Description	UOM	Price
T20076	Lift Out Tongs, Length 500mm	EACH	£3.95

## Pickling Tongs, Copper

Why use copper tongs:

After soldering gold silver platinum copper brass use copper tongs to place and remove your work from your acid pickling solutions. If normal steel tongs tweezers are use you will get a reaction from your acid bath and your work will come out black/discoloured

- Bent or fork end available
- Long reach safe to use keeping your hands distance from acid solutions
- Recommended to use with our copper pans electric acid pickling baths see code P5166 and B31898
- Length 220mm
- Weight 70 grams

## Bent, 200mm Copper Tongs



Code	Description	UOM	Price
T6282	Bent, 200mm Copper Tongs	EACH	£3.95

## Fork, 200mm Copper Tongs



Code	Description	UOM	Price
T6283	Fork, 200mm Copper Tongs	EACH	£3.95

## Pickling Tongs, Stainless Steel

### Pickling Tongs, Length 320mm



- Universal scissor action tongs
- Stainless steel so great for pickling
- Ideal to handle large soldering work such as badges, pendants, gate bracelet's etc
- Recommended to hold and pick up our selection of crucibles and pots (smaller sizes)
- Bent nose serrated tips
- Length 320mm
- Fully opens to 240mm
- Weight 135grams

Code	Description	UOM	Price
C22667	Pickling Tongs, Length 320mm	EACH	£5.95

## CRUCIBLES, SALAMANDERS & STIRRING RODS

Huge selection of melting or smelting crucibles and salamander plus stirring rods available in various types, sizes & materials.

Our range will cater for your demand of many types of metals precious or none precious metals and other types of material.

Gold, Silver, Platinum, Copper, Brass, Aluminium, Pewter, Bronze, Tin, Lead, Glass, Iron, Some types of resin, Modelling wax etc.

- Long lifespan assuring you many melts
- Selected quality assured by our manufactures using the best material
- Large range of refractory surroundings available to protect ones work surfaces see code S8596
- Flat crucibles are for direct heat source melting such as a torch system Sievert (code B33067)
- Salamander pots are for chamber heating furnaces or making your own chamber using heat refractory materials see codes S4255 and S8596

Hints and tips using your crucibles/melting pots:

Before melting any type of metal in your crucible/salamander one must prepare it by glazing. This is because when various melt's are done you will find it will not stick to the crucible.

There is the element of metal loss when melting but used correctly you can minimize this process. Remember don't throw away your crucible/salamander put it with your lemel sweeps as precious metals are all retrievable from any surface.

For flat crucibles open heat torch melt you have to prepare before you melt by glazing the crucible:

1. Surrounded the crucible necessary refractory boards blocks start heating
2. Heat with your Sievert torch until you a cherry red colour.
3. Sprinkle Borax powder over it evenly and let it cool down for 10 - 15 minutes.
4. Place your required amount of scarp metal/casting grain into the crucible and start melting with your Sievert torch .
5. Add borax when metal starts turning in to cherry red colour and notice how it starts flowing
6. Pour into your desired ingot casting sand mould etc.

Heat chamber melting pots salamanders and furnace pots:

1. Sprinkle borax into melting pot and add your scarp/casting grain
2. Start heating your crucible once it starts looking a reddish colour sprinkle on the metal some borax
3. The borax will start masking the metal flow as it taking the oxygen from the air letting the metal run
4. Stir with your quartz/carbon rod this stops the molten metal going into a shape of a ball or button mixing your borax into the metal
5. Pour into your desired ingot casting mould etc.

## Crucibles Round - A\*F & Bergeon



- Round Ceramic
- BASED ON PLATINUM
- P13749 - 200 grams

Code	Description	UOM	Price
P13749	Ø64mm Round A*F Platinum Melting Cup	EACH	£10.50
C0412	Ø95mm Round Crucible (for Vissin) - Bergeon 4668 - Fireproof China	EACH	£26.95

## Crucibles (Square, Shoe & Dish) - Made in Italy



- Square Flat Ceramic
- Shoe (centrifugal caster) Ceramic
- Bowl
- Made in Italy

BASED ON 22ct GOLD CAPACITY

C32195 - 15 grams	C32197 - 60 grams
C32196 - 30 grams	C32199 - 30 grams
C32196 - 45 grams	C32200 - 60 grams

Code	Description	UOM	Price
C32195	50 x 50 x 25mm Cousins Crucible	EACH	£2.25
C32196	70 x 70 x 26mm Cousins Crucible	EACH	£2.50
C32197	80 x 80 x 28mm Cousins Crucible	EACH	£2.50
C32198	100 x 100 x 28mm Cousins Crucible	EACH	£2.50
C32199	62mm Wide Cousins Shoe Crucible	EACH	£9.50
C32200	85mm Wide Cousins Shoe Crucible	EACH	£9.95
B39331	Ø75mm Cousins Bowl Crucible	EACH	£5.95

## Crucibles (Square & Dish) - Value



- Square Flat
- Dish
- Excellent value
- Made in India

Code	Description	UOM	Price
C42917	Dish Crucible Ø30mm	EACH	£0.95
C42918	Dish Crucible Ø40mm	EACH	£1.45
C42919	Dish Crucible Ø50mm	EACH	£1.75
C42920	Dish Crucible Ø60mm	EACH	£1.95
C42906	Square Crucible 50mm	EACH	£2.95
C42907	Square Crucible 65mm	EACH	£2.95
C42908	Square Crucible 75mm	EACH	£2.95

**Crucible with Wooden Handle**



- Ø50mm crucible with pouring lip
- Mounted on a steel & wooden handle
- Overall length 305mm
- Handle is removable meaning the crucible can be used on its own

Code	Description	UOM	Price
C45717	Crucible with Wooden Handle	EACH	£6.95

**Melting Furnace Crucibles**



Machined solid graphite generic crucibles

- Generic furnace crucibles
- Made from fine grade graphite for optimum performance and durability
- Melting weights approximately based on 22ct gold
- Made in India

Dimensions:

- C39325: 115 x 125 x Ø50mm (Ø65mm)
- C39326: 135 x 150 x Ø55mm (Ø75mm)
- C41195: 145 x 170 x Ø60mm (Ø75mm)

Shaft length x overall length x shaft diameter Ø (lip diameter Ø)

Code	Description	UOM	Price
C39325	1kg Capacity Crucible	EACH	£7.50
C39326	2kg Capacity Crucible	EACH	£9.95
C41195	3kg Capacity Crucible	EACH	£12.50

**Melting Furnace Crucibles, Italian**



Machined solid graphite crucibles for our Cousins furnace range.

Melting Furnaces:

- F32186 (1kg)
- F32187 (2kg)
- F32188 (3kg)
- F45595 (4kg)

Specification:

- Melting weights approximately based on 22ct gold
- Only the best quality materials are used assuring many melts
- Made in Italy

Code	Description	UOM	Price
C32202	1kg Melting Furnace Crucible	EACH	£14.95
C32203	2kg Melting Furnace Crucible	EACH	£21.95
C32204	3kg Melting Furnace Crucible	EACH	£24.50
C45596	4kg Melting Furnace Crucible	EACH	£29.50

**Morganite Clay Graphite Salamander Pots**



The worlds favourite Salamander "Super Crucibles" manufactured by The Morganite Crucible Company (est - 1856)

- High quality bonded clay graphite crucibles, range manufactured by plastic forming techniques.
- Salamander super crucibles are used to provide consistent performance in fuel-fired furnaces and medium/high frequency induction furnaces.
- Particularly used to melt precious and none precious metals gold, silver, copper, brass, aluminium, bronze, pewter and grey iron.
- Typical metal cast melting temperature 850 °c – 1600 °c (1562 – 2912 °F)
- Ultimate performance characteristics include clean melting, good thermal conductivity, good resistance to chemical corrosion and high refractoriness.
- Salamander super crucibles are manufactured from premium grade raw materials (ISO9000:2000 quality standards)
- For further dimensions see additional info
- Made in UK

Salamander Clay Graphite Pots Sizes:

- A5/0, approx capacity grms: 16 gold, 90 silver. (Height 36mm)
- A3/0, approx capacity grms: 30 gold, 160 silver. (Height 54mm)
- A1/0, approx capacity grms: 91 gold, 510 silver. (Height 66mm)
- A0.5, approx capacity kg: 2.2 gold, 1.3 silver. (Height 80mm)
- A1, approx capacity kg: 2.76 gold, 1.50 silver. (Height 99mm)
- A2, approx capacity kg: 4.60 gold, 2.50 silver. (Height 110mm)
- A3, approx capacity kg: 8.05 gold, 4.40 silver. (Height 128mm)
- A4, approx capacity kg: 11.04 gold, 6.00 Silver. (Height 140mm)
- A5, approx capacity kg: 13.80 gold, 7.56 silver. (Height 151mm)
- A6, approx capacity kg: 18.40 gold, 10.00 silver. (Height 165mm)
- A8, approx capacity kg: 25.30 gold, 13.86 silver. (Height 190mm)
- A12, approx capacity kg: 39.10 gold, 21.42 silver. (Height 203mm)

Code	Description	UOM	Price
C9520	A5/0 Morganite Salamander	EACH	£13.95
C9521	A3/0 Morganite Salamander	EACH	£15.95
C9522	A1/0 Morganite Salamander	EACH	£16.65
C9523	A0.5 Morganite Salamander	EACH	£19.95
C9524	A1 Morganite Salamander	EACH	£20.25
C9525	A2 Morganite Salamander	EACH	£23.50
C9526	A3 Morganite Salamander	EACH	£24.95
C9527	A4 Morganite Salamander	EACH	£29.75
C9528	A5 Morganite Salamander	EACH	£34.95
C9529	A6 Morganite Salamander	EACH	£42.50
C32429	A8 Morganite Salamander	EACH	£44.95
C32430	A12 Morganite Salamander	EACH	£56.50

**Stirring Rods**



Heat tolerant stirring rods help remove impurities and skim metal surfaces as you stir metals.

When your crucible is full with metal and the temperature set slightly under your setting point stir with appropriate stirring rod

Stirring your metal with a stirring rod will give you a good clean flow when you are ready to pour into ingot moulds

- Carbon stirring rods are for standard use approximately 4 to 6 melts
- Quartz stirring rods for high use approximately 10+ melts

Sizes:

- C13733: Ø10mm x 355mm Length
- C39329 & C32201: Ø10mm x 300mm Length

Code	Description	UOM	Price
C13733	Quartz Stirring Rod	EACH	£19.95
C39329	Graphite Stirring Rod, Indian	EACH	£1.50
C32201	Graphite Stirring Rod, Italian	EACH	£3.95

**Stirring Rod Handle**



- Sturdy stirring rod gripper
- Keeps you a safe distance from any molten metal
- Wooden handle with with stainless steel body
- Stirring rods held in place using a side screw lock
- Includes two carbon graphite stirring rods
- 450mm overall length
- Can hold rods up to Ø15mm diameter

Code	Description	UOM	Price
S45543	Stirring Rod Handle	PACK*3	£9.95

**INGOT MOULDS**

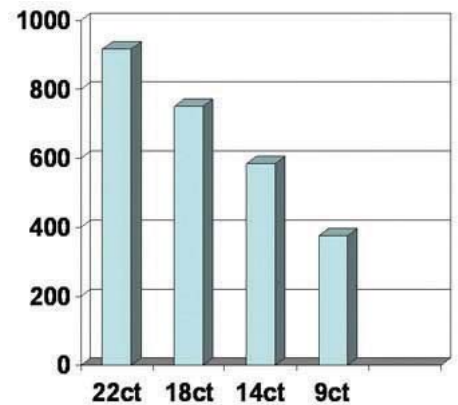

The proportion of precious metal in an alloy is measured in parts per thousand by weight. Previously the number of parts called carats, of precious metal in 24 parts of alloy was used for example, 22ct gold is an alloy in which 22/24 or just over 916 parts per 1000 are pure gold.

- Gold 916.6 (22ct)
- Gold 750 (18ct)
- Gold 585 (14ct)
- Gold 375 (9ct)

Guide to preparing your ingots before casting. (Please see below for associated products.)

1. Place your ingot mould on a refractory board. Heat your ingot with a gas torch uniformly for about five to fifteen minutes. For best results heat the ingot to a cherry red colour.
  2. Sprinkle borax powder into the grooves/ crevice evenly just enough to cover surface of the ingot. For adjustable ingots sprinkle the borax before this process.
  3. Carefully pour the molten gold/silver into the ingot mould.
  4. Leave the ingot to cool down naturally. If you immerse the ingot in water to cool there is a risk that the ingot itself could crack.
  5. If the gold/silver ingot gets stuck tap with a mallet (M4752) and it will drop out. Using a metal hammer increases the probability of shattering the ingot.
  6. To clean off fire stain and oxides put the ingot into pickling or sulphuric acid.
  7. Stamp your ingot with marking punches 9ct, 22ct etc
- All capacities are approximate and are based on 24ct pure gold.  
Please remember that there is always an element of wastage involved with melting.

## Adjustable Ingot Moulds

### Steel Two-Part Ingot Moulds

Please note approximate weights are calculated from pure gold 24ct.

Also please take into consideration when melting gold there is a element of small wastage

These high quality made Adjustable Ingot Moulds are particularly useful to melt scrap metal.

- Make your own size bars etc highly useful for rolling sheet/wire on a rolling mill.
- Easily enables you to manufacture investment bars of gold/silver for your customers.
- An excellent method to store scrap gold compactly and to make transportation of scrap in bulk easier and safer.
- The mould height/width is adjusted by sliding the free plate and clamp to produce the desired size.
- Made in steel

### Size & Weight:

- i31894: 60 x 55 x 100mm, 1050g
- i31895: 60 x 80 x 130mm, 1530g
- i31896: 60 x 110 x 130mm, 1784g
- i31897: 150 x 70 x 180mm, 2600g

Click the info window for maximum size of each ingot mould / chamber.

## 125g Adjustable Ingot Mould

- Mould Size
- Capacity: 125g
  - Height: 50mm
  - Length: 45mm
  - Depth: 3.5mm



Code	Description	UOM	Price
I31894	125g Adjustable Ingot Mould	EACH	£13.95

## 234g Adjustable Ingot Mould

- Mould Size
- Capacity: 234g
  - Height: 70mm
  - Length: 45mm
  - Depth: 4.5mm



Code	Description	UOM	Price
I31895	234g Adjustable Ingot Mould	EACH	£19.70

## 312g Adjustable Ingot Mould

- Mould Size
- Capacity: 312g
  - Height: 100mm
  - Length: 45mm
  - Depth: 4.5mm



Code	Description	UOM	Price
I31896	312g Adjustable Ingot Mould	EACH	£21.85

## 780g Adjustable Ingot Mould

- Mould Size
- Capacity: 780g
  - Height: 135mm
  - Length: 70mm
  - Depth: 5.5mm



Code	Description	UOM	Price
I31897	780g Adjustable Ingot Mould	EACH	£31.85

## Cast Ingot Moulds

### Steel Ribbon Ingot Moulds

These high quality made Ingot Moulds are particularly useful to melt scrap metal.

- Make your own size bars and wires, highly useful for rolling sheet/wire on a rolling mill.
- Easily enables you to manufacture investment bars of gold/silver for your customers.
- An excellent method to store scrap gold compactly and to make transportation of scrap in bulk easier and safer.
- A wide range of sizes available
- Made in steel

### Size and weight:

- I31888: 280 x 28 x 28mm, 910g
- I36080: 380 x 25 x 28mm, 1600g
- I5467: 300 x 30 x 25mm, 1000g
- I5197: 330 x 48 x 25mm, 1500g
- I5198: 365 x 32 x 25mm, 1500g
- I19222: 395 x 60 x 20mm, 3000g
- I31887: 310 x 40 x 40mm, 1350g

Click the additional info button to see specific mould sizes as well as maximum capacities (approximately based on 24ct gold).

Also, please take into consideration when melting gold and silver there is an element of small wastage.

## 2+1 Grooves, Indian



- Mould Sizes:
- 4 x 160mm
  - 5 x 160mm

- 16 x 160mm
- Mould Capacity:
- 1 x 125g
  - 2 x 55g

Code	Description	UOM	Price
I31888	2+1 Grooves, Indian	EACH	£6.95

## 2+1 Grooves, Indian, Extra Long



- Mould sizes
- 6 x 235mm x 2
  - 8 x 235mm

- Mould Capacity:
- 1 x 190g
  - 2 x 85g

Code	Description	UOM	Price
I36080	2+1 Grooves, Indian, Extra Long	EACH	£13.95

## 2+1 Grooves, Italian



- Mould sizes:
- 7 x 170mm, 8 x 170mm, 20 x 170mm

- Mould Capacity:
- 1 x 100g, 2 x 45g

Code	Description	UOM	Price
I5467	2+1 Grooves, Italian	EACH	£26.95

## 3+1 Grooves, Italian



- Mould sizes
- 7 x 195mm, 8 x 195mm
  - 9 x 195mm, 35 x 195mm

- Mould Capacity:
- 1 x 80g, 3 x 10g

Code	Description	UOM	Price
I5197	3+1 Grooves, Italian	EACH	£36.95

## 3+3 Grooves, Italian



- Mould sizes
- 4 x 140mm, 5 x 140mm, 7 x 140mm

• 9 x 140mm, 11 x 100mm, 19 x 100mm

Mould Capacity:  
1 x 12g, 1 x 10g, 1 x 4g  
1 x 8g, 1 x 6g, 1 x 3g

Code	Description	UOM	Price
I5198	3+3 Grooves, Italian	EACH	£62.95

### 6+2 Grooves, Italian



- Very good for making Ingots/Nuggets
- Ideal for forming scrap into useful bars
- Double sided
- Side 1 has 6 capacities 5, 10, 20, 30, 40 and 50gm
- Side 2 has 100 and 200gm

Code	Description	UOM	Price
I19222	6+2 Grooves, Italian	EACH	£83.95

### 2+2+1+1 Grooves, Indian



- Black Anodised
- High Grade Steel
- Length 200mm
- 4 Sided
- Overall Length 310mm

Mould Sizes:  
• 5.5 x 205mm x 2  
• 8 x 205mm x 2  
• 11 x 205mm  
• 16 x 205mm

Mould Capacity:  
• 1 x 158g  
• 1 x 100g  
• 2 x 35g  
• 2 x 8g

Code	Description	UOM	Price
I31887	2+2+1+1 Grooves, Indian	EACH	£17.95

### Combination Ingot Moulds

When ever precious metal is required for your workshop manufacturing, repairing or investment bar service, an adjustable, combination ingot is an essential bit of kit

- 80 or 100mm height available, with 4 or hole options
- Different sizes bars can be moulded
- Reverse the plate to form round and half round moulds
- Solid hardened steel construction, durable giving prolonged usage
- Durston Made in Great Britain or economical Indian made available
- Durston supplied either with G clamp or C clamp
- One half of the mould is fixed to a base, the other is free so can be used to form any size required
- Please see additional information of individual specification

**PRICE PROMISE  
GUARANTEE** ✓

### 80mm (4 Hole) Durston

- Mould height 80mm
- Bar mould width 4.5mm
- Bar mould length adjustable from 10 to 50mm
- 4 round moulds, diameter Ø4, 5, 6 & 7mm
- Base size 80 x 60 x 10mm
- C clamp with sturdy handle included
- Total weight 1.8kg
- Durston 1601
- Made in UK



Code	Description	UOM	Price
I42159	80mm (4 Hole) Durston	EACH	£49.95

### 80mm (4 Hole) Indian

- Mould height 80mm
- Bar mould width 4mm
- Bar mould length adjustable from 10 to 50mm
- 4 round moulds, diameter Ø3, 4, 5 & 6mm
- Base size 100 x 50mm
- G clamp included
- Total weight 1.3kg



Code	Description	UOM	Price
I34916	80mm (4 Hole) Indian	EACH	£17.95

### 80mm (6 Hole) Durston

- Mould height 80mm
- Bar mould width 4.5mm
- Bar mould length adjustable from 10 to 70mm
- 6 round moulds, diameter Ø4, 5, 6, 7, 8 & 10mm
- Base size 110 x 60 x 10mm
- C clamp with sturdy handle included
- Total weight 2.8kg
- Durston 1603
- Made in UK



Code	Description	UOM	Price
I42161	80mm (6 Hole) Durston	EACH	£51.95

### 100mm (4 Hole) Durston

- Mould height 100mm
- Bar mould width 4.5mm
- Bar mould length adjustable from 10 to 50mm
- 4 round moulds, diameter Ø4, 5, 6, 7mm
- Base size 80 x 60 x 10mm
- C clamp with sturdy handle included
- Total weight 2.7kg
- Durston 1602
- Made in UK



Code	Description	UOM	Price
I42160	100mm (4 Hole) Durston	EACH	£55.65

### 100mm (6 Hole) Durston

- Mould height 10mm
- Bar mould width 4.5mm
- Bar mould length adjustable from 10 to 70mm
- 6 round moulds, diameter Ø4, 5, 6, 7, 8 & 10mm
- Base size 110 x 60 x 10mm
- C clamp with sturdy handle included
- Total weight 3.3kg
- Durston 1604
- Made in UK



Code	Description	UOM	Price
I42162	100mm (6 Hole) Durston	EACH	£56.95

### Open Ingot Moulds

These high quality made Ingot Moulds are particularly useful to melt scrap metal.

- Easily enables you to manufacture investment bars of gold/silver for your customers.
- An excellent method to store scrap gold compactly and to make transportation of scrap in bulk easier and safer.
- A wide range of sizes available
- Made in steel

Please note approximate weights are calculated from pure gold 24ct. Also please take into consideration when melting gold there is a element of small wastage

Overall Size and Weight:

- R5199: 190 x 35 x 50mm, 1130g
- i31889: 185 x 45 x 45mm, 930g
- i31890: 205 x 40 x 60mm, 1300g
- R5200: 380 x 48 x 70mm, 1800g
- i31891: 245 x 50 x 80mm, 2400g

### 500g (70 x 35 x 25mm) Italian



- Cast Iron

Code	Description	UOM	Price
R5199	500g (70 x 35 x 25mm) Italian	EACH	£28.50

### 1.3kg (120 x 45 x 35mm) Italian



- Overall length 380mm

Code	Description	UOM	Price
R5200	1.3kg (120 x 45 x 35mm) Italian	EACH	£46.20

Cutters,  
Guillotines &  
Shears

See Page 833



Alphabetical &  
Numerical Punch  
Sets

See Page 969



## 2kg (85 x 35 x 33mm) Indian



Code	Description	UOM	Price
I31889	2kg (85 x 35 x 33mm) Indian	EACH	£8.95

## 3kg (112 x 45 x 30mm) Indian



Code	Description	UOM	Price
I31890	3kg (112 x 45 x 30mm) Indian	EACH	£9.95

## 7.5kg (140 x 60 x 38mm) Indian



Code	Description	UOM	Price
I31891	7.5kg (140 x 60 x 38mm) Indian	EACH	£11.95

## INVESTMENT MIXING BOWLS

### Investment Mixing Bowls



#### Investment Mixing Bowls

- Made from soft rubber, flexible enough for easy pouring yet strong enough to hold the mixture
- 3 different sizes/capacities
- Perfect for centrifugal casting and lost wax casting
- Also great for general use

#### Capcities (approx)

- B39339: 750ml
- B39340: 1.70 litres
- B39341: 4.50 litres

Code	Description	UOM	Price
B39339	Ø100mm Rubber Bowl	EACH	£3.95
B39340	Ø150mm Rubber Bowl	EACH	£6.95
B39341	Ø230mm Rubber Bowl	EACH	£11.95

## Spatula



- Useful for mixing, forming and shaping investment mix, wax or clay
- Flexible stainless steel
- 150 x 25mm blade
- 265mm overall length

Code	Description	UOM	Price
S39347	Spatula	EACH	£2.50

## SOLDERING BLOCKS, BOARDS & PADS



We have a large selection refractory soldering blocks, boards and pads.

- The best buy for long-life soldering pads available in sizes to fit adequately to the working space.
- Will not flake or crumble and can be sanded to restore its original surface quality.
- Highly heat-reflective with a fast cooling period.
- Can endure temperatures up to approximately 1100°C, allowing the soldering of any silver and gold qualities.
- These durable, smooth-surfaced asbestos free pads protect work areas from burning during soldering, annealing and melting.
- Place hot flakes on them after casting.
- Ideal for laying out flat work for production soldering: can be drilled or shape to meet your specific size needs.
- Use KOS Fire Cement (C33167) when joining pads together to seal the surface.

### Charcoal Soldering Block



#### Charcoal Blocks

The traditional jeweller's soldering block. Use Auflux and charcoal blocks together to protect the surface of the bench and to create an efficient soldering area. Made from select, close-grain, knot-free, natural willow especially prepared and treated for optimum performance. Charcoal under the flame creates a reducing atmosphere for a cleaner soldering environment.

- Reflects heat from the surface effectively excelling soldering results
- Maximum temperature it will tolerate approximately 3000° c
- Size 140 x 70 x 30mm

Please note: retain the block shape by wrapping the sides tightly with binding wire (Code W32434) before use.

Code	Description	UOM	Price
C0378	Charcoal Block	EACH	£7.85

### Monolux Soldering Block



Block - 125 x 75 x 25mm

- Monolux
- Asbestos free
- Rectangular
- Made in Great Britain

Code	Description	UOM	Price
S4255	125 x 75 x 25mm Monolux Block	EACH	£3.65
Price breaks available, see website			

### Rectangular Soldering Block, Bergeon Swiss



Block - 140 x 70 x 35mm

- Bergeon 6446E
- Asbestos Free Insulating Pad
- For temperatures up to 1100°C
- Resistant to monoxides of carbon as well as hydrocarbon
- Non-toxic
- Odorless
- Porosity 86%
- Pointed metallic articles may easily be stuck into the insulator

Code	Description	UOM	Price
I0877	140 x 70 x 35mm Block, Bergeon	EACH	£10.95

### Square Soldering Boards

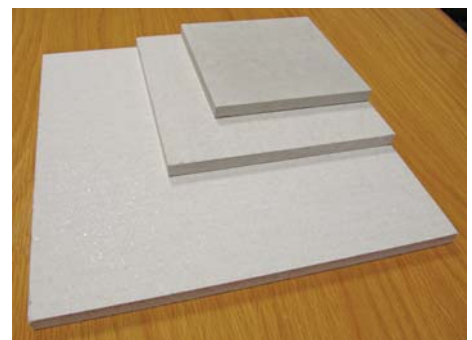

- Sizes Square: 150, 200 & 300mm
- Asbestos Free Insulating Pad
- For temperatures up to 1100°C
- Non-toxic
- Odourless



- Pointed metallic articles may easily be stuck into the insulator
- Made in Great Britain

Code	Description	UOM	Price
<b>S8594</b>	150 x 150 x 12mm Square Board	EACH	<b>£2.35</b>
<b>S8595</b>	200 x 200 x 12mm Square Board	EACH	<b>£5.25</b>
<b>S8596</b>	300 x 300 x 12mm Square Board	EACH	<b>£5.45</b>

**Raised Soldering Board**



- 150 x 150mm
- Feet keep the board raised above your bench for easier working
- Will withstand very high temperatures
- Asbestos Free Insulating Pad
- Cordiorite
- Non-toxic
- Odourless
- 700g

Code	Description	UOM	Price
<b>B45744</b>	150 x 150mm Raised Soldering Board	EACH	<b>£9.50</b>

**Round Soldering Boards**



- Bergeon 6446G, H & J
- Size: Ø120, 140 & 190mm
- Asbestos Free Insulating Pad
- For temperatures up to 1100°C
- Resistant to monoxides of carbon as well as hydrocarbon
- Non-toxic
- Odorless
- Porosity 86%
- Pointed metallic articles may easily be stuck into the insulator

Code	Description	UOM	Price
<b>I0879</b>	Ø120 x 12mm Circular Pad	EACH	<b>£15.95</b>
<b>I0880</b>	Ø140 x 12mm Circular Pad	EACH	<b>£16.50</b>
<b>I0878</b>	Ø190 x 12mm Circular Pad	EACH	<b>£18.50</b>

**SOLDERING PLATES & HONEYCOMB BOARDS**

A large selection of soldering plates rigged and Honeycomb are available.

- Place the Honeycomb block on top of two soldering blocks giving approximately 7cm of height from the soldering surface. This, in combination with the perforated surface

*ventilates the working area and creates the ideal environment for soldering.*

- *High heat-reflectivity with a fast cooling time frame.*
- *Because of its nature, heat is dispersed all over the board ultimately prolonging its life span.*
- *Maximum temperature it will tolerate is approximately 1100°C.*

**Cordierite Soldering Plate**

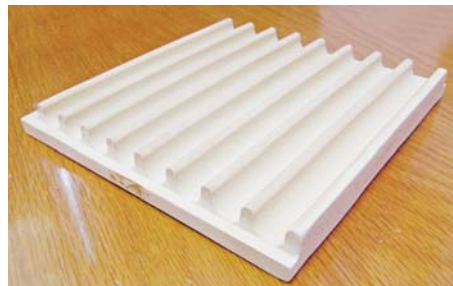

- Bergeon 6601D
- Insulating plate In cordierite
- To solder platinum alloys
- Retains heat
- Reversible
- Working temperature around 1100°C max.
- 1 side even and 1 side indented
- Dimensions: 184 x 184 x 25 mm

Code	Description	UOM	Price
<b>I0884</b>	184 x 184 x 25 mm Cordierite Plate	EACH	<b>£66.95</b>

**Honeycomb Soldering Boards**

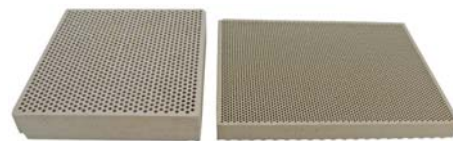

- Extra thick and long lasting Honeycomb soldering boards
- A ceramic material (asbestos free) which resists temperatures up to approximately 982°C
- The holes can be utilised to hold work with binding wire (B0087) and Pins (P4922 for I33820)
- Insulating Plate In Semi-Cordierite
- Dust free

Code	Description	UOM	Price
<b>I33820</b>	100 x 100 x 20mm Semi Cordierite Plate	EACH	<b>£3.95</b>
<b>I0882</b>	135 x 90 x 10mm Semi Cordierite Plate, A*F Swiss	EACH	<b>£5.95</b>

**SOLDERING STANDS, PICKS, WIGS AND MISCELLANEOUS**

**Alcohol Lamp & Wick**

Alcohol Lamp & Wick

An alcohol lamp consists of a small glass jar with a wick which goes through the lid of the jar. It can also be used in place of a Bunsen burner for gentle heating of something in a workshop/laboratory.



The glass jar is filled with alcohol/methylated spirit which is flammable. A wick dipped in the alcohol draws alcohol up through the lid, where it burns, like a candle. It can be used for heating at low temperatures.

- It's a useful tool when working with modelling wax, heating it & then shaping with your wax tools
- Harden your graver tips by heating towards the cutting edge
- Ideal for softening shellac when setting palate stones and impulse pins
- Can be used for blueing screws by holding over the heat in a pan and tempering steel
- Multi angled glass body designed for positioning in various angles
- Will ideally hold approx. 90ml of methylated spirits which allows you to tilt the jar into any position without spillage

Size: 120 x 70mm  
Weight: 250g

Code	Description	UOM	Price
<b>A0002</b>	Alcohol Lamp	EACH	<b>£3.95</b>
<b>W1852</b>	Alcohol Lamp Wick	EACH	<b>£1.95</b>

**Binding Wire**

Binding Wire - Multi Purpose

Use this profoundly soft wire for easily binding delicate projects or easing intricate soldering jobs.

- Tie pieces together ready for soldering and wrapping on charcoal soldering blocks to prevent cracking.
- Binding wire will not stick to your solder or work while under heat.

**Ø0.30mm Iron Binding Wire**

- Ø.30mm (34 gauge)
- Iron Binding Wire for holding parts together while soldering
- 50 grams



Code	Description	UOM	Price
<b>W32434</b>	Ø0.30mm Iron Binding Wire	50G	<b>£1.95</b>

**Ø0.30mm Iron Binding Wire**

- Ø.30mm (34 gauge)
- 3 Kgs
- Iron Binding Wire for holding parts together while soldering



Code	Description	UOM	Price
<b>W31925</b>	Ø0.30mm Iron Binding Wire	3KG	<b>£17.95</b>

**Ø0.28mm Iron Binding Wire**

- Ø0.28mm
- Galvanised Iron



Code	Description	UOM	Price
<b>W41182</b>	Ø0.28mm Iron Binding Wire	225g	<b>£5.95</b>



## Ø0.36mm Iron Binding Wire

- Ø0.36mm
- Galvanised Iron



Code	Description	UOM	Price
W41180	Ø0.36mm Iron Binding Wire	225g	£5.95

## Ø0.40mm Iron Binding Wire

- Ø0.40mm
- Galvanised Iron



Code	Description	UOM	Price
W41178	Ø0.40mm Iron Binding Wire	225g	£5.95

## Ø0.40mm Binding Wire, UK Made

- Ø0.40mm
- 70 x Ø25mm Reel
- For holding parts together while soldering
- 120g



Code	Description	UOM	Price
B0087	Ø0.40mm Binding Wire, UK Made	120G	£5.15

## Ø0.44mm Iron Binding Wire

- Ø0.44mm
- Galvanised Iron



Code	Description	UOM	Price
W41181	Ø0.44mm Iron Binding Wire	225g	£5.95

## Ø0.55mm Iron Binding Wire

- Ø0.55mm
- Galvanised Iron



Code	Description	UOM	Price
W41179	Ø0.55mm Iron Binding Wire	225g	£5.95

## Ceramic Ring Sticks & Stands

The perfect hands free soldering aid!

The ceramic ring stick and base is the ultimate solution in tackling awkward soldering jobs; for example controlling the flow of solder or accessing an obstructed part of a ring to solder, etc is an ever pressing problem. Using this ceramic ring stick on a stand gives the user a heat resistant surface amalgamated with a third hand to make soldering straightforward.

We supply two differently manufactured types of this tool, the original Bergeon Swiss and also the economical Indian brand, giving excellent value.

Comprising a cast iron base with a fitted swivel ball, while the metal clip locks the ceramic holder in place and is easily adjustable to raise and lower the stick depending on the diameter of the ring. The adjustable ball swivel enables versatile use allowing repositioning of work as frequently as required.

Replacement ceramic sticks are available and are interchangeable with one another for both models. Ring stick stand also available separately, code S45720

### Ceramic Ring Stick on Base, Non Swiss



- Size: 120mm x 150mm x 60mm
- Weight 550g

Code	Description	UOM	Price
R20132	Ceramic Ring Stick on Base, Non Swiss	EACH	£12.50

### Ceramic Ring Stick, Non Swiss



- Replacement stick for R20132 or R1458
- Size 150mm x 15mm x 25mm
- Weight: 100g

Code	Description	UOM	Price
R20131	Ceramic Ring Stick, Non Swiss	EACH	£7.25

### Copper Bowls for Pickling

See Page 817



## Ceramic Ring Stick On Base, Bergeon Swiss



- Size: 110mm x 145mm x 80mm
- Weight 560g

Code	Description	UOM	Price
R1458	Ceramic Ring Stick On Base, Bergeon Swiss	EACH	£30.95

## Ceramic Ring Stick Stand

- Base and holder for ceramic ring sticks (R20131)
- Will also hold the graphite ring sticks (W42910)
- Heavy cast base
- Rubber bottom for extra stability
- 360° double ball joint manoeuvrability
- 400g



Code	Description	UOM	Price
S45719	Stand for Ceramic Ring Sticks	EACH	£6.95

## Graphite Ring Stick & Stand



The perfect hands free soldering aid!

The graphite ring stick and base is the ultimate solution in tackling awkward soldering jobs. Using this graphite ring stick on a stand gives the user a heat resistant surface amalgamated with a third hand to make soldering straightforward. Rings, bracelets and earrings can be soldered with ease by placing them on the ring stick, giving you hands free soldering.

- Graphite ring stick, molten metals will not stick
- Carbon material helps keep oxygen away from your solder, excellent for silver
- Ring stick Ø16 to 24mm, 150mm long
- Supplied on sturdy Ø65mm base

• Ring stick stand also available separately, code S45720

Code	Description	UOM	Price
W42910	Graphite Stick on Base	EACH	£8.50
W47916	Graphite Ring Stick	EACH	£3.50

### Jewellers Blow Pipe



Blow Pipe - Brass

Brass blow pipes have been used for well over 200 years by jewellers, glass craft people, lab works etc. For many fields of industry it's an old favourite capable of soldering, fusing, and heating. It consists of a brass tube bent at a right angle with a capped head with a miniature hole.

- Use in conjunction with an alcohol lamp (code A0002)
- Blow through, keeping the cheeks fully puffed out, inhaling through the nose in typical blowpipe fashion, so as to maintain a steady stream of air to produce a very sharp, intensely hot flame.
- As traditional jewellers have quoted many a time in our Jewellery quarter Birmingham Showroom, using a brass blow pipe gives you more control and you feel at one with the flame

Length: 300mm

Code	Description	UOM	Price
B8676	Brass Blow Pipe	EACH	£2.80

### Pouring Dish



Used to hold & pour oil, water and anything else that might be required in the soldering and heating process.

- Aluminium
- Weight 15gm
- Width 55mm
- Height 15mm
- 15g

Code	Description	UOM	Price
P19166	Ø55mm Pouring Dish	EACH	£2.30

### Solder Picks

#### 160mm Solder Pick, A\*F Swiss



An old favourite, high quality titanium soldering pick. This hi heat tolerant, titanium steel pick has a non-stick tip. Will not contaminate or discolour gold, silver or platinum.

- 16cm Long
- Aluminium Handle
- Fine point
- For manoeuvring molten solder
- Made in USA

Code	Description	UOM	Price
S4182	160mm Solder Pick, A*F Swiss	EACH	£6.80

### 200mm Solder Pick, Indian



Iron non stick end with wooden insulating handle. Ideal for gold, silver, copper, brass & soldering work. Please note, not for use with platinum

- 20cm Long
- Wooden Handle
- Fine Point
- For manoeuvring molten solder

Code	Description	UOM	Price
S4919	200mm Solder Pick, Indian	EACH	£1.50

### Solder Picks, Set of 3, Indian



Titanium soldering pick set. Colour coded, stay-cool handles allow you to dedicate picks to specific karats which prevents cross contamination. Non-stick titanium tips avoids solder from adhering. Use with gold and silver. Please note not for use with platinum.

- Set of 3 Aluminium Handle, Titanium blade Solder Picks.
- Hex Handles with specific colours allow you to dedicate picks with specific karats to avoid mixing and contamination.
- 170mm

Code	Description	UOM	Price
S31262	Solder Picks, Set of 3, Indian	PACK*3	£5.25

### Solder Stands



Soldering Stands

Before you ask it's not for cake decorating but a very handy soldering aid. Excellent for the demanding soldering jobs.

- Take off the top plate and screw down the holding base to your work surface
- Place your soldering reflective materials on the solder stand circular disc. For instance solder blocks, charcoal, master board etc. And move the turntable to any position (360 c) while soldering
- Steel construction strong and very durable
- Please note lifting the solder stand the bottom can detach

Dimensions (table diameter x overall height):

- B45745: Ø125 x 40mm (2Kg)
- S4198: Ø150 x 70mm (800g)
- S37639: Ø190 x 55mm (1.15Kg)
- S4199: Ø200 x 70mm (2.4Kg)

Code	Description	UOM	Price
B45745	Ø125mm Solder Stand, Raised Rim	EACH	£29.95
S4198	Ø150mm Solder Stand, UK Made	EACH	£43.20
S37639	Ø190mm Solder Stand	EACH	£11.95
S4199	Ø200mm Solder Stand, UK Made	EACH	£52.95



### Soldering Wig or Boss



Soldering Wig

- This circular mat of twisted iron wire allows heat to flow all around the job with minimum amounts of heat dispersion
- Can grasp firmly by the handle
- Traditionally also known as the solder boss
- With wire handle and eye

Code	Description	UOM	Price
S4235	Ø90mm Solder Wig or Boss, UK Made	EACH	£15.45
S1532	Ø100mm Solder Wig or Boss, Bergeon Swiss	EACH	£36.95

### Third Hand (Side Screw)



Soldering Third Hand - Indian - Heavy Base

- Excellent budget soldering apparatus for holding work leaving your hands free to solder
- 360° double ball joint manoeuvrability with two sturdy wing nut fixings, allowing you to angle your tweezers any way you could need
- Heavy Base
- Rubber ring on base, giving more stability

Dimensions:

- Base diameter: Ø65mm
- Weight: 435g
- Holding gap: 3.10mm across x 11.50mm deep

Code	Description	UOM	Price
S37631	Soldering Third Hand	EACH	£4.75

PRICE PROMISE GUARANTEE

### Micro Flame Torch

See Page 656



## Third Hand (Side Screw) with Tweezers



Soldering Third Hand - Indian - With Tweezers

- Excellent budget soldering apparatus for holding work leaving your hands free to solder
- Comes with crossover locking tweezers (replacements code T4913, T4914)
- 360° double ball joint manoeuvrability with a sturdy wing nut fixing, allowing you to angle your tweezers any way you could need

Dimensions:  
 • Tweezers length: 160mm  
 • Base diameter: Ø65mm  
 • Weight: 350g

Code	Description	UOM	Price
S36081	Soldering Third Hand with Tweezer	EACH	£4.50

## Third Hand (Side Screw) with Tweezers



Soldering Third Hand - Indian - With Tweezers

- Excellent budget soldering apparatus for holding work leaving your hands free to solder
- Comes with crossover locking tweezers (replacements code T4913, T4914)
- 360° ball joint manoeuvrability with a sturdy wing nut fixing, allowing you to angle your tweezers any way you could need
- Heavy duty rounded chrome stand with padded base

Dimensions:  
 • Tweezers length: 160mm  
 • Base diameter: Ø65mm  
 • Weight: 400g

Code	Description	UOM	Price
T38758	Soldering Third Hand with Tweezer	EACH	£6.95

## Third Hand (Side Screw) with Insulated Tweezers



Soldering Third Hand - Indian - With Insulated Tweezers

- Excellent budget soldering apparatus for holding work leaving your hands free to solder
- Comes with crossover locking insulated tweezers (replacements code T4913, T4914)
- 360° ball joint manoeuvrability with a sturdy wing nut fixing, allowing you to angle your tweezers any way you could need
- Ball joint is magnetic to base, can be easily removed simply by lifting it out
- Ball joint
- Heavy steel base with padded bottom and delrin support

Dimensions:  
 • Tweezers length: 160mm  
 • Base diameter: Ø75mm  
 • Weight: 560g

Code	Description	UOM	Price
T45545	Soldering Third Hand with Tweezer	EACH	£10.50

## Third Hand (Top Screw)



Soldering Third Hand - Made in UK

- Holds such tweezers as self-locking (Cousins Ref. T4913/T4914)
- Steel construction

Code	Description	UOM	Price
S4247	Soldering Third Hand	EACH	£29.95

## Third Hand on Soldering Board



Soldering Third Hand - Double Clamps - With Soldering Board

Comprising of two fine nosed spring loaded clamps, which articulate universally on adjustable 120mm tall stands positioned either side of a 50mm square heat resistant solder board.

- Includes 150mm square grey transite board for high heat tolerance
- Compact design and all mounted on a single plinth measuring 230 x 150mm overall.

Code	Description	UOM	Price
S31899	Soldering Third Hand on Soldering Board	EACH	£14.95

**WORLDWIDE DELIVERY**

## Third Hand with Clamp



Soldering Third Hand - Single Clamp

- Free standing, square base
- Triple jointed, ensuring maximum flexibility
- Heavy iron base prevents tipping
- Serrated jaws
- Supplied with x2 spare serrated jaws

Dimensions:  
 • Base 65 x 65mm  
 • Overall height 150mm  
 • Clip jaw serrated length 20mm

Code	Description	UOM	Price
S45720	Helping Hand with Crocodile Clip	EACH	£16.95

## Third Hand with Crocodile Clips



Soldering Third Hand - Double Clamps

- Can be held in vice, clamped to bench or left free standing
- Wing nuts and removable crocodile clips hold any objects firmly in position
- Tweezers can also be used
- Six ball joints allow adjustments to the exact angles you need
- Centre bar can slide up and down, giving maximum flexibility
- Heavy iron base prevents tipping
- Base 60 x 60mm

Code	Description	UOM	Price
H39338	Helping Hands with Crocodile Clips	EACH	£9.95



**ORDER tracking**

Soldering & Brazing by AR Turpin

See Page 1379



**Third Hand with Magnifier**



Soldering Third Hand - Double Clamps - With Magnifying Glass

- Can be held in vice or clamped to bench.
- Wing nuts and removable crocodile clips hold any objects firmly in position
- Tweezers can also be used
- Eight ball joints allow adjustments to the exact angles you need.
- Heavy iron base prevents tipping.
- Glass magnifier Ø63mm diameter.
- Base 60 x 60mm

Code	Description	UOM	Price
H31868	Helping Hands with Magnifier	EACH	£14.95

**Third Hand Torch Holder**



Soldering Third Hand - For Soldering Torch - Superior Quality

Superior quality with larger diameter holes for storing micro welder tips. A useful third hand to hold your micro welder torch, giving you both hands free to craft and solder metals with great accuracy. Similar to the jeweller's side light.

- With securing hole so you can screw down to bench (screw not supplied)
- Includes 6 micro torch tip holders in base
- Heavy, sturdy base
- Also a great neat and tidy stand for when you aren't using your micro welder torch
- Popular with handmade chain makers, filigree wire soldering etc.

- Dimensions:
- Tip holes diameter: Ø8.50mm
  - Height: 110mm
  - Base: Ø75mm
  - Weight: 435g

Code	Description	UOM	Price
S36264	Soldering Torch Stand	EACH	£6.95

**Third Hand Torch Holder**

Soldering Torch Stand

- Holes in base so you can securely screw to desk/work bench (screws not supplied)
- Great for keeping your hands free
- Useful storage stand for when not in use

- Dimensions:
- Overall height 300mm
  - Width 30mm
  - 250g



Code	Description	UOM	Price
T39337	Soldering Torch Stand	EACH	£2.50

**Third Hand Torch Holder**

Soldering Torch Stand

- Threaded bottom for screwing directly into work bench
- Can be held in a vice
- Great for keeping your hands free
- Useful storage stand for when not in use

- Dimensions:
- Overall height 290mm
  - 80g



Code	Description	UOM	Price
T39336	Soldering Torch Stand	EACH	£1.95

**Third Hand Torch Holder, Magnetic**



Soldering Third Hand - For Soldering Torch - Magnetic

A useful third hand to hold your micro welder torch, giving you both hands free to craft and solder metals with great accuracy. Similar to the jeweller's side light.

- Magnetic holding of torch
- 7 holes for holding tips
- Heavy base giving stability
- Popular with handmade chain makers, filigree wire soldering etc.
- Also a great neat and tidy stand for when you aren't using your micro welder torch
- Made in India

- Dimensions:
- Tip holes diameter: Ø9.00mm
  - Height: 100mm
  - Base: Ø70mm
  - Weight: 780g

Code	Description	UOM	Price
S37138	Magnetic Torch Holder	EACH	£11.20

**Third Hand Torch Holder**



Soldering Third Hand - For Soldering Torch

A useful third hand to hold your micro welder torch, giving you both hands free to craft and solder metals with great accuracy. Similar to the jeweller's side light.

- With securing hole so you can screw down to bench (screw not supplied)
- 6 holes for holding tips
- Also a great neat and tidy stand for when you aren't using your micro welder torch
- Popular with handmade chain makers, filigree wire soldering etc.

- Dimensions:
- Tip holes diameter: Ø4.60mm
  - Height: 130mm
  - Base: Ø70mm
  - Weight: 350g

Code	Description	UOM	Price
S36082	Soldering Torch Stand	EACH	£3.50

**Spark Lighter**



Spark Lighter

- For lighting LPG gas torches (ideal for Sievert Torch Systems, see B0128).
- The cup shaped shield traps the gas within and ignites instantly.
- No gas filling, safe and economical to use.
- Hold in the centre and put the torch's nozzle near the cup recess; press the two sides together and the flint will rub over centre texture plate, this will light the torch.
- Made from steel
- 190 x 40 x 15mm
- Weight: 75g

- Replacement flints
- For use with C34122
  - 10 flints per pack
  - Weight: 15g

Code	Description	UOM	Price
S34122	Spark Lighter	EACH	£1.95
S34123	Spark Lighter Flints	PACK*10	£1.50

**TODAY SAME DAY DISPATCH**

**Flush Cutting Cutters**

See Page 829



**TRIPODS & WIRE MESH**

**Tripods**

A tripod is primarily used during "sweat" soldering, a technique used to solder a (usually) flat piece of metal on top of another larger one. Solder is gently melted on to the back of the smaller piece - melted just enough so that it flows as evenly as possible across the back but not so much that it actually starts to flow of the metal itself.

This smaller piece is then put in position on top of the larger piece, the work is then refluxed and the solder melted again. The trick is to make sure that this time you keep the heat mainly on the larger piece of metal so that you don't melt the smaller piece.

It can also be placed over an alcohol lamp or Bunsen burner to keep a wax pot/dish warm.

Also available:

- Dish crucibles for melting and preparing enamels/wax, Cousins Ref C0413, C0412
- Light weight mesh, Cousins Ref S20866

**Tripod Stand and Mesh, Indian**



- Height: 230mm
- Diameter: 110mm – resting plate
- Mesh size: 150mm square
- Weight: 735 grams

Code	Description	UOM	Price
T34947	Tripod Stand and Mesh, Indian	EACH	£5.95

**Tripod Stand, Bergeon**



- Bergeon 4669
- Steel construction
- Height: 140mm
- Diameter: 110mm
- Weight: 70 grams

Code	Description	UOM	Price
C0407	Tripod Stand, Bergeon	EACH	£39.95

**Tripod Screen Wire Mesh**



Screen Wire Mesh

- Rest your soldering/heating jobs on top and see excellent reflective heat capabilities with this fine steel mesh.
- Also used in conjunction with a traditional Bunsen burner/tripod (see code T34927)
- 10 mesh squares per square inch

Overall size: 150 x 150mm (6" x 6")  
Weight: 50g

Code	Description	UOM	Price
S20866	Screen Wire Mesh	EACH	£2.20

**Spanners - Combination**

- Combination spanner and wrench
- Carbon, heat treated steel
- Spanner sizes: 4.5, 5, 5.5, 6 & 7mm
- Wrench sizes: 5, 5.5, 6, 7 & 8mm
- Pack\*5



Code	Description	UOM	Price
S42904	Spanner Set	PACK*5	£3.50

**SPIRIT LEVELS**

**Spirit Levels**

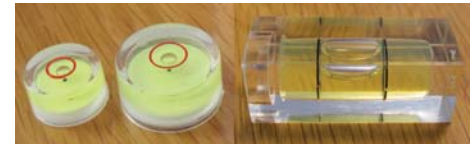

The spirit level is a widely used tool by many professions, including jeweller's clock makers, model makers. Ceramics arts, gun makers and photography, as well as homeowners engaged in do-it-yourself projects. Spirit levels, or bubble levels, come in all shapes and sizes. They're easy to use, and can be employed for a variety of tasks.

How to use...

1. Test the spirit level to make sure it is calibrated. This can be done by placing the spirit level on a level surface and visually confirming that the bubble is in the centre of the two lines on the spirit tube. Turn the level around and replace on the same surface. The bubble should not have shifted in any direction. Repeat for each tube on the level, assuring that the entire level is accurately calibrated.
2. Place the spirit level on the object or surface that you wish to be perfectly horizontal (level), or vertical (plumb).
3. Adjust the spirit level until the bubble is centred between the two lines. This is done to get an idea of how much the object or surface must move to become level or plumb.
4. Adjust the object until it is level or plumb, according to the level.

Made in Acrylic

- Weights:  
G33894 - 2 grams  
G33895 - 3 grams  
G33896 - 10 grams

Code	Description	UOM	Price
G33894	Ø15 x 8mm, Bulls Eye Vial Spirit Level	EACH	£1.50
G33895	Ø20 x 10mm, Bulls Eye Vial Spirit Level	EACH	£1.95
G33896	15 x 40mm, Rectangular Vial Spirit Level	EACH	£2.25

**SPANNERS**

**Spanners - Adjustable**



Soft Grip Adjustable Wrench 150mm (6")

- "I" section construction.
- Drop forged.
- 25mm jaw capacity.
- Moulded handle.
- 10mm ring spanner.

Code	Description	UOM	Price
S33520	150mm Adjustable Spanner	EACH	£4.95

**Heat Protection Gloves**

See Page 721



**Screen Wire Mesh for Soldering**

See Page 1014



**SECURE** **ONLINE ORDERING**

## SPRING BAR TOOLS

### SPRING BAR CURVING TOOLS

#### Spring Bar Curving Pliers, Cousins



Spring Bar Curving - Pliers

- Easily curve spring bars
- Pressure exerted through pliers
- Overall length 135mm
- Made in India

Code	Description	UOM	Price
P37634	Spring Bar Pliers	EACH	£4.25

#### Spring Bar Curving Tool, Horotec Swiss



Spring Bar Curving - Horotec Swiss

The Horotec spring bar curving tool allows you to bend even the thickest of spring bars with ease.

- 110mm long lever allows greater force to be applied with smaller pressure
- 2 different bending chambers (small and large), so the bend is proportionate to the spring bar length
- Appropriate size chambers greatly reduces the risk of damaging the spring bar
- Can be screwed to bench (screws not included)
- Horotec 10.311

Dimensions:

- 130 x 30 x 80mm
- 120g

Code	Description	UOM	Price
S44236	Spring Bar Curving Tool, Horotec Swiss	EACH	£74.95

PRICE PROMISE GUARANTEE

### SPRING BAR REMOVING TOOLS

#### Spring Bar Tool - Bergeon 3153



- Ø0.80mm pin (L0937)
- 3mm wide fork (L0936)
- Hexagonal black bakelite handle
- Graduated in mm for measuring distance between lugs
- Length: 148mm

Code	Description	UOM	Price
L0935	Spring Bar Tool, Bergeon 3153	EACH	£12.50
L0936	Fork End, Bergeon 3153A	EACH	£2.10
L0937	Pin End, Bergeon 3153B	EACH	£0.69

Price breaks available, see website

#### Spring Bar Tool - Bergeon 6111



- Pin Ø0.80mm & Fork 1mm (L0939A)
- 4mm angled fork (L0939B)
- Tool with reversible point and spatula-shaped fork
- Nickel plated
- Knurled handle
- Gripping with chuck
- Length: 140 mm

Double ended Pin & Fork End:

- Pin Ø0.80mm & Fork 1mm
- Bergeon 6111D (L0939A)

Fork:

- 4mm wide, Angled
- Bergeon 6111E (L0939B)

Code	Description	UOM	Price
L0938	Bergeon 6111 Spring Bar Tool	EACH	£21.50
L0939A	Pin & Fork End, Bergeon 6111D	EACH	£3.45
L0939B	Fork End, Bergeon 6111E	EACH	£3.50

#### Spring Bar Tool - Bergeon 6767F, Fine Ends



- Ø0.80mm pin
- 1mm wide fork
- With fine points (L0942) and forks (L0941)
- Bergeon 6767F
- Handle in polish nickel plated brass
- Points in hardened tempering steel
- Length: 145 mm

Code	Description	UOM	Price
L0940	Spring Bar Tool (Fine Ends), Bergeon 6767F	EACH	£8.50
L0941	Fork End (Fine) Bergeon 6767AF	EACH	£1.60
L0942	Pin End (Fine) Bergeon 6767BF	EACH	£0.99

Price breaks available, see website

#### Spring Bar Tool - Bergeon 6767S, Standard Ends



- Ø0.80mm pin
- 3mm wide fork
- With Standard points (L0945) and forks (L0944)
- Bergeon 6767S

- Handle in polish nickel plated brass
- Points in hardened tempering steel
- Length: 145 mm

Code	Description	UOM	Price
L0943	Spring Bar Tool (Standard End) Bergeon 6767S	EACH	£8.90
L0944	Fork End (Standard) Bergeon 6767A	EACH	£1.75
L0945	Pin End (Standard) Bergeon 6767B	EACH	£1.05

Price breaks available, see website

#### Spring Bar Tool - Bergeon 6825



- Tool for bracelets with spring bars, including Rolex
- Fantastic for removing spring bars in bracelets with curved ends
- Can be locked at a specific width
- Fine quality aluminium casting
- Very easy to handle
- Capacity: 10 to 30mm
- Length: 95mm
- Two fork positions (0 degrees and 45 degrees)
- Supplied with 2 reversible (standard size) forks in stainless steel
- Fine tips fork available (R38752)
- Bergeon 6825

Fork dimensions (Fork width x tips width):

- Standard: 1.30mm x 0.33mm

Code	Description	UOM	Price
R38673	Spring Bar Tool, Bergeon 6825	EACH	£122.95
R38674	Spring Bar Tool Fork	EACH	£10.95

#### Spring Bar Tool - Bergeon 6825.PF (Fine Tips)



- Tool for bracelets with spring bars, including Rolex
- Extra fine tips
- Fantastic for removing spring bars in bracelets with curved ends
- Can be locked at a specific width
- Fine quality aluminium casting
- Very easy to handle
- Capacity: 10 to 30mm
- Length: 95mm
- Two fork positions (0 degrees and 45 degrees)
- Supplied with 2 reversible (standard size) forks in stainless steel
- Standard tip fork available: R38674
- Bergeon 6825.PF

Fork dimensions (Fork width x tips width):

- Fine: 1.10mm x 0.23mm

Code	Description	UOM	Price
R47763	Spring Bar Tool, Bergeon 6825.PF (Fine Ends)	EACH	£125.00
R38752	Spring Bar Tool Fork, Extra Fine	EACH	£11.50

**Spring Bar Tool - Bergeon 7825**



- Tool for bracelets with spring bars
- Fine quality aluminium casting
- Very easy to handle
- Allows the removal of the bracelet from the case, without removing the clasp
- Fine tips and arms allow easy access to the spring bar
- Replacement tips available
- Tip width 1.00mm
- Tip length 2.50mm
- Bergeon 7825

Code	Description	UOM	Price
T41939	Spring Bar Tool, Bergeon 7825	EACH	£99.95
T41940	Replacement Ends for Spring Bar Tool, Bergeon 7825-BR	PAIR	£89.95

**Spring Bar Tool - Cousins**

These high quality spring bar tools have an excellent feel about them. They are solid and durable with a knurled handle giving that extra grip capability.

The ends are easily replaced by unscrewing the chuck that holds them in place and they both come in their own wallet or holder for easy storage, transport and protection.

Replacements:

- Pin & Fork End = L0939A
- Large Fork = L0939B

**Spring Bar Tool**



- Reversible Pin Ø0.80mm & Fork Ø1.20mm
- Knurled handle
- Solid feel, good quality
- Gripping with chuck
- Handle length: 90mm
- Supplied in plastic wallet

Code	Description	UOM	Price
L37433	Spring Bar Tool	EACH	£8.95

**Spring Bar Tool, Double Ended**



- Reversible Pin Ø0.80mm & Fork Ø1.20mm
- With 6mm angled fork
- Knurled handle
- Solid feel, good quality
- Gripping with chuck
- Handle length: 110mm
- Supplied in push top plastic holder

Code	Description	UOM	Price
L37432	Spring Bar Tool, Double Ended	EACH	£16.75



**Quick Release Spring Bars**

See Page 638

**Spring Bar Tool - Indian**

**Spring Bar Remover**



- Ø0.80mm pin
- 3mm wide fork
- Hexagonal black acrylic handle
- Graduated in mm for measuring distance between lugs
- Length: 150mm
- Weight 30gms
- Made in India

Code	Description	UOM	Price
L31324	Spring Bar Remover	EACH	£0.95

**Spring Bar Remover, Aluminium Deluxe**



- Lightweight aluminium
- Ø0.80mm pin x2
- 2.5mm wide fork x 2
- Pins and forks are reversible
- Length: 130mm
- Japanese style
- Indian

Code	Description	UOM	Price
S42901	Spring Bar Remover, Aluminium Deluxe	EACH	£2.50

**Spring Bar Remover, Fine**



- Ø0.80mm pin
- 1.4mm wide fork
- With fine points and forks
- Length: 150mm
- Indian

Code	Description	UOM	Price
L31325	Spring Bar Remover, Fine	EACH	£1.75

**Spring Bar Remover, Mini**



- Ø0.80 pin
- 1.80mm wide fork
- Plastic grip
- Length 65mm
- Inexpensive if lost or damaged

Code	Description	UOM	Price
S37142	Spring Bar Remover, Mini	EACH	£1.50

**Spring Bar Remover, Multi Pin**



- With 3 pins: Ø0.60, 0.80 & 1.00mm
- With forked end
- Knurled handle
- Stainless Steel
- Overall length 70mm

Code	Description	UOM	Price
S38767	Spring Bar Remover, Multi Pin	EACH	£1.65

**STAKING SETS, BLOCKS & PUNCHES**

**HOLE CLOSING & RIVETING CLOCK PUNCHES**

**Hole Closing Punches, Set of 7**

- For clock plates (retracting self centring pin)
- Set of 7 closing punches for worn pivot and shaft holes where re-bushing is inappropriate
- Suitable for small or large clocks with brass plates
- Supplied in a plastic box
- Weight 155g
- Made in India



Code	Description	UOM	Price
P20879	Hole Closing Punches, Set of 7	EACH	£20.50

**Clock Punches & Riveting Stake Set**



- 13 Hole Stake
- 16 Punches Ø1.40mm to 5.00mm (Flat and Domed plus 2 Hole Closing Punches)
- Wooden Stand (85mm x 120mm)

Code	Description	UOM	Price
P32054	Clock Punches & Riveting Stake Set	EACH	£33.95

**Hammers & Mallets**

See Page 905



## STAKING & RIVETING BLOCKS

Large selection of staking blocks are available for watchmakers, clockmakers and jewellers as it can be used as a base for riveting & drilling or for bushing & closing holes.

All steel staking blocks are case hardened and well polished to ensure a long life. We have various types from 9 holes to 36 holes and some have machined slits incorporated.

### 9 Hole

- Ø50mm
- 11mm Thick
- Holes: Ø3 to 10mm
- Steel



Code	Description	UOM	Price
S32058	Riveting Round Stake with 9 Holes	EACH	£2.75

### 9 Hole with V

- 9 holes from Ø0.80 to Ø4.00mm
- With V stake
- 4 Serrations
- Steel
- Made in India



Code	Description	UOM	Price
S36502	Riveting Stake with V Stake	EACH	£4.95

### 9 Hole, Brass

- Brass body Ideal for protecting soft clock parts
- 9 holes from Ø1.50 to Ø6.00mm
- With added feature of opening slide action
- 73 x 25 x 13mm



Code	Description	UOM	Price
S9729	Split 9 Hole Riveting Stake	EACH	£10.90

### 15 Hole

- Holes from Ø0.90 to Ø6.10mm
- 5 Slots
- 55 x 45 x 18mm
- Steel
- Made in India



Code	Description	UOM	Price
S36482	Riveting Stake, 15 Hole, Indian	EACH	£6.95

### Centre Punch Tools

See Page 920



### 15 Hole, Bergeon 1907

- With holes from Ø0.80 to Ø6.30mm
- 4 Slots
- Size: 46 x 46 x 15mm
- Steel
- Bergeon Swiss



Code	Description	UOM	Price
S1539	Bergeon 1907 15 Hole Riveting Stake	EACH	£81.80

### 15 Hole, Bergeon 30205

- With holes from Ø2.00 to Ø8.60mm
- 4 Slots
- Size: 65 x 45 x 20mm
- Steel
- Bergeon Swiss



Code	Description	UOM	Price
S7679	Bergeon 30205 15 Hole Riveting Stake	EACH	£53.95

### 24 Hole, Bergeon 1901

- With holes from Ø0.50 to Ø2.20mm
- Steel
- Bergeon Swiss



Code	Description	UOM	Price
S1537	Bergeon 1901 24 Hole Riveting Stake	EACH	£21.95

### 36 Hole

- 2 Sizes
- 36 hole staking blocks
- Steel
- Made in India



Dimensions:  
• Smallest hole size to maximum hole size (plate size)

Code	Description	UOM	Price
S47502	Ø0.25 to 2.35mm Holes (55 x 20 x 5mm)	EACH	£3.50
S47501	Ø0.50 to 3.75mm Holes (75 x 25 x 10mm)	EACH	£3.85

### 36 Hole, Bergeon 1902

- With holes from Ø0.50 to Ø2.50mm
- Steel
- Bergeon Swiss



Code	Description	UOM	Price
S1538	Bergeon 1902 36 Hole Riveting Stake	EACH	£23.95

## WATCH STAKING SETS

### Staking Set



- Contents:
- 1 Staking tool
  - 120 punches, tempered steel for extra strength
  - 20 stakes
  - Punches are diameter Ø5mm
  - Wooden storage box with additional storage draw
  - Made in India

Code	Description	UOM	Price
S39653	Staking Set	EACH	£259.95

### Staking Set - Bergeon 1808.92A (made by Star)



"Star" and "Bergeon" collaboration has produced this excellent and practical version comprising of a nickel plated cast stake holder frame with lockable rotating stake plate. With height adjustable micrometer base, which enables the punches to be fitted instead of the stakes. Bergeon Swiss, made by Star.

- Contents:
- 1 Staking tool
  - 105 punches
  - 20 stakes
  - Strong wooden storage box

Code	Description	UOM	Price
S1543	Bergeon 1808-92A Staking Set	EACH	£695.00

**Bergeon Rodico  
Cleaning Compound**  
See Page 1194



**SAME DAY  
DISPATCH**



## Staking Set - Bergeon 5285B



Bergeon 5285B staking set.

- Diecast alloy
- Matt chromed
- Adjustable tube Ø4.70mm
- Knurled nut enables adjustment of shake
- All punches and stakes are fitted in a numbered gilded metal plate
- Each punch is likewise numbered
- A special cap enables gripping of punches for removal
- Bergeon 5285B

Contents:

- 1 Staking tool
- 50 punches
- 10 stakes
- Strong wooden storage box

Code	Description	UOM	Price
S7684	Bergeon 5285B Staking Tool	EACH	£359.95

## Staking Set - Bergeon 5285D



Comprehensive Bergeon 5285D staking set

- Diecast alloy
- Matt chromed
- Adjustable tube Ø4.70mm
- Knurled nut enables adjustment of shake
- All punches and stakes are fitted in a numbered gilded metal plate
- Each punch is likewise numbered
- A special cap enables gripping of punches for removal
- Bergeon 5285D

Contents:

- 1 Staking tool
- 1 Staking tool base
- 100 punches
- 20 stakes

- Strong wooden storage box

Code	Description	UOM	Price
S1541	Bergeon 5285D Staking Tool	EACH	£695.00

## Staking Set Spindle, Collets & Stop Ring, Bergeon



Bergeon 30601-127-131

- Staking Set Spindle, Collets & Stop Ring
- Fits Bergeon staking frame and features a set of 4 collets
- With an adjustable stop ring give depth control
- Collets Ø: 0.80mm, 1.00mm, 1.20mm and 1.50mm capacity

Code	Description	UOM	Price
S7683	Spindle, Collets & Stop Ring, Bergeon 30601-127-131	EACH	£95.75

## Staking Tool, Bergeon 5285



- Bergeon 5285
- Staking Tool (Base not included)
- Diecast iron press
- Matt chromed
- Fine workmanship
- Adjustable tube
- Ø4.7mm
- Knurled nut enables adjustment of shake

Code	Description	UOM	Price
S8293	Staking Tool, Bergeon 5285	EACH	£129.95

## Staking Tool Base, Bergeon 5285S



- Bergeon 5285S
- Staking tool base
- Raising the staking tool allows the use of punches as stakes

Code	Description	UOM	Price
S1542	Tool Base, Bergeon 5285S	EACH	£59.95



**SAME DAY DISPATCH**

## WATCH STAKING SET INDIVIDUAL PUNCHES

### Staking Punch Cap

Bergeon 5285G - Swiss Made

- A special cap enables gripping of punches for removal



Code	Description	UOM	Price
P7647	Punch Cap, Bergeon 5285G	EACH	£4.25

### Centering Spindle Staking Punch

Bergeon - Swiss Made

- Punch Ø4.7mm
- The last 3 digits of Bergeon 5285 \*\*\* is stamped on the original and replacement Punch

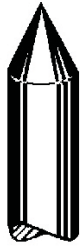

Code	Description	UOM	Price
P7637J	293 Punch, Bergeon 5285	EACH	£3.95

### Chamfering Staking Punch

Bergeon - Swiss Made

- Punch Ø4.7mm
- The last 3 digits of Bergeon 5285 \*\*\* is stamped on the original and replacement Punch.



Code	Description	UOM	Price
P7639	296 (Ø1.00mm) Punch, Bergeon 5285	EACH	£7.95
P7639A	297 (Ø2.00mm) Punch, Bergeon 5285	EACH	£7.95
P7639B	298 (Ø3.00mm) Punch, Bergeon 5285	EACH	£7.95
P7639C	299 (Ø4.00mm) Punch, Bergeon 5285	EACH	£7.95

### Concaved Drilled Staking Punch

Bergeon - Swiss Made

- Punch Ø4.7mm
- The last 3 digits of Bergeon 5285 \*\*\* is stamped on the original and replacement Punch



Bergeon 5285-235 to 247  
• Sizes: Hole Ø x Outer Ø

Code	Description	UOM	Price
P7635	235 (Ø0.40mm x Ø2.00mm) Bergeon	EACH	£3.65
P31034	236 (Ø0.45mm x Ø2.10mm) Bergeon	EACH	£3.65
P7635B	237 (Ø0.50mm x Ø2.20mm) Bergeon	EACH	£3.65
P7635C	238 (Ø0.60mm x Ø2.40mm) Bergeon	EACH	£3.65
P7635D	239 (Ø0.70mm x Ø2.60mm) Bergeon	EACH	£3.65

P31035	240 (Ø0.80mm x Ø2.80mm) Bergeon	EACH	£3.65
P31036	241 (Ø0.90mm x Ø3.00mm) Bergeon	EACH	£3.65
P7635G	242 (Ø1.00mm x Ø3.20mm) Bergeon	EACH	£3.65
P31037	243 (Ø1.20mm x Ø3.40mm) Bergeon	EACH	£3.65
P30597	244 (Ø1.40mm x Ø3.60mm) Bergeon	EACH	£3.65
P7635J	245 (Ø1.60mm x Ø3.70mm) Bergeon	EACH	£3.65
P31038	246 (Ø1.80mm x Ø3.80mm) Bergeon	EACH	£3.65
P7635L	247 (Ø2.00mm x Ø4.00mm) Bergeon	EACH	£3.65

**Domed Drilled Staking Punch**

Bergeon - Swiss Made

- Punch Ø4.7mm
- The last 3 digits of Bergeon 5285 \*\*\* is stamped on the original and replacement Punch



Bergeon 5285-248 to 272  
• Sizes: Hole Ø x Outer Ø

Code	Description	UOM	Price
P7635M	248 (Ø0.30 x Ø2.00mm) Bergeon	EACH	£3.65
P31039	249 (Ø0.35 x Ø2.10mm) Bergeon	EACH	£3.65
P7635O	250 (Ø0.40 x Ø2.20mm) Bergeon	EACH	£3.65
P7635P	251 (Ø0.45 x Ø2.30mm) Bergeon	EACH	£3.65
P7635Q	252 (Ø0.50 x Ø2.40mm) Bergeon	EACH	£3.65
P7635R	253 (Ø0.55 x Ø2.55mm) Bergeon	EACH	£3.65
P7635S	254 (Ø0.60 x Ø2.60mm) Bergeon	EACH	£3.65
P7635T	255 (Ø0.65 x Ø2.70mm) Bergeon	EACH	£3.65
P21971	256 (Ø0.70 x Ø2.80mm) Bergeon	EACH	£3.65
P31040	257 (Ø0.75 x Ø2.75mm) Bergeon	EACH	£3.65
P31041	258 (Ø0.80 x Ø2.80mm) Bergeon	EACH	£3.65
P31042	259 (Ø0.85 x Ø2.85mm) Bergeon	EACH	£3.65
P7635Y	260 (Ø0.90 x Ø2.90mm) Bergeon	EACH	£3.65
P7635Z	261 (Ø0.95 x Ø2.05mm) Bergeon	EACH	£3.65
P7635ZA	262 (Ø1.00 x Ø3.00mm) Bergeon	EACH	£3.65
P7635ZB	263 (Ø1.10 x Ø3.10mm) Bergeon	EACH	£3.65
P19764	264 (Ø1.20 x Ø3.20mm) Bergeon	EACH	£3.65
P7635ZD	265 (Ø1.30 x Ø3.30mm) Bergeon	EACH	£3.65
P19767	266 (Ø1.40 x Ø3.40mm) Bergeon	EACH	£3.65
P7635ZF	267 (Ø1.50 x Ø3.50mm) Bergeon	EACH	£3.65
P19766	268 (Ø1.60 x Ø3.60mm) Bergeon	EACH	£3.65
P19766	269 (Ø1.80 x Ø3.80mm) Bergeon	EACH	£3.65
P31043	270 (Ø2.00 x Ø4.00mm) Bergeon	EACH	£3.65
P31044	271 (Ø2.20 x Ø4.20mm) Bergeon	EACH	£3.65
P19228	272 (Ø2.50 x Ø4.50mm) Bergeon	EACH	£3.65

**Domed Undrilled Staking Punch**

Bergeon - Swiss Made

- Punch Ø4.7mm
- The last 3 digits of Bergeon 5285 \*\*\* is stamped on the original and replacement Punch



Code	Description	UOM	Price
P7636	273 (Ø1.00mm) Bergeon	EACH	£3.75
P7636A	274 (Ø1.30mm) Bergeon	EACH	£3.75
P7636B	275 (Ø1.50mm) Bergeon	EACH	£3.75
P31045	276 (Ø1.70mm) Bergeon	EACH	£3.75
P7636D	277 (Ø1.90mm) Bergeon	EACH	£3.75
P7636E	278 (Ø2.00mm) Bergeon	EACH	£3.75

P7636F	279 (Ø2.40mm) Bergeon	EACH	£3.75
P21972	280 (Ø2.70mm) Bergeon	EACH	£3.75
P7636H	281 (Ø3.00mm) Bergeon	EACH	£3.75
P30596	282 (Ø4.00mm) Bergeon	EACH	£3.75

**Flat Drilled Staking Punch**

Bergeon - Swiss Made

- Punch Ø4.7mm
- The last 3 digits of Bergeon 5285 \*\*\* is stamped on the original and replacement Punch



Bergeon 5285-200 to 224  
• Sizes: Hole Ø x Outer Ø

Code	Description	UOM	Price
P7633	200 (Ø0.30mm x Ø2.00mm) Bergeon	EACH	£3.65
P7633A	201 (Ø0.35mm x Ø2.10mm) Bergeon	EACH	£3.65
P7633B	202 (Ø0.40mm x Ø2.20mm) Bergeon	EACH	£3.65
P7633C	203 (Ø0.45mm x Ø2.30mm) Bergeon	EACH	£3.65
P7633D	204 (Ø0.50mm x Ø2.40mm) Bergeon	EACH	£3.65
P7633E	205 (Ø0.55mm x Ø2.50mm) Bergeon	EACH	£3.65
P7633F	206 (Ø0.60mm x Ø2.60mm) Bergeon	EACH	£3.65
P7633G	207 (Ø0.65mm x Ø2.70mm) Bergeon	EACH	£3.65
P7633H	208 (Ø0.70mm x Ø2.80mm) Bergeon	EACH	£3.65
P7633I	209 (Ø0.75mm x Ø2.90mm) Bergeon	EACH	£3.65
P7633J	210 (Ø0.80mm x Ø3.00mm) Bergeon	EACH	£3.65
P7633K	211 (Ø0.90mm x Ø3.10mm) Bergeon	EACH	£3.65
P7633L	212 (Ø1.00mm x Ø3.20mm) Bergeon	EACH	£3.65
P7633M	213 (Ø1.10mm x Ø3.30mm) Bergeon	EACH	£3.65
P7633N	214 (Ø1.20mm x Ø3.40mm) Bergeon	EACH	£3.65
P7633O	215 (Ø1.50mm x Ø3.50mm) Bergeon	EACH	£3.65
P31030	216 (Ø1.40mm x Ø3.60mm) Bergeon	EACH	£3.65
P7633Q	217 (Ø1.50mm x Ø3.70mm) Bergeon	EACH	£3.65
P7633R	218 (Ø1.60mm x Ø3.75mm) Bergeon	EACH	£3.65
P31031	219 (Ø1.70mm x Ø3.80mm) Bergeon	EACH	£3.65
P7633T	220 (Ø1.90mm x Ø3.85mm) Bergeon	EACH	£3.65
P31032	221 (Ø2.00mm x Ø4.00mm) Bergeon	EACH	£3.65
P31033	222 (Ø2.20mm x Ø4.20mm) Bergeon	EACH	£3.65
P7633W	223 (Ø2.40mm x Ø4.40mm) Bergeon	EACH	£3.65
P7633X	224 (Ø2.60mm x Ø4.50mm) Bergeon	EACH	£3.65

**Flat Undrilled Staking Punch**

Bergeon - Swiss Made

- Punch Ø4.7mm
- The last 3 digits of Bergeon 5285 \*\*\* is stamped on the original and replacement Punch



Code	Description	UOM	Price
P7634	225 (Ø1.00mm) Bergeon	EACH	£3.65

P7634A	226 (Ø1.20mm) Bergeon	EACH	£3.65
P7634B	227 (Ø1.40mm) Bergeon	EACH	£3.65
P7634C	228 (Ø1.60mm) Bergeon	EACH	£3.65
P7634D	229 (Ø1.80mm) Bergeon	EACH	£3.65
P7634E	230 (Ø2.20mm) Bergeon	EACH	£3.65
P7634F	231 (Ø2.60mm) Bergeon	EACH	£3.65
P7634G	232 (Ø3.00mm) Bergeon	EACH	£3.65
P7634H	233 (Ø3.70mm) Bergeon	EACH	£3.65
P7634I	234 (Ø4.20mm) Bergeon	EACH	£3.65

**Screw Removing Staking Punch**

Bergeon - Swiss Made

- Punch Ø4.7mm
- The last 3 digits of Bergeon 5285 \*\*\* is stamped on the original and replacement Punch

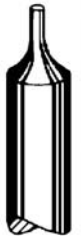

Code	Description	UOM	Price
P7637	283 (Ø0.30mm) Bergeon	EACH	£4.25
P7637A	284 (Ø0.40mm) Bergeon	EACH	£4.25
P7637B	285 (Ø0.50mm) Bergeon	EACH	£4.25
P7637C	286 (Ø0.60mm) Bergeon	EACH	£4.25
P7637D	287 (Ø0.70mm) Bergeon	EACH	£4.25
P7637E	288 (Ø0.80mm) Bergeon	EACH	£4.25
P7637F	289 (Ø0.90mm) Bergeon	EACH	£4.25
P7637G	290 (Ø1.00mm) Bergeon	EACH	£4.25
P7637H	291 (Ø1.20mm) Bergeon	EACH	£4.25
P7637I	292 (Ø1.50mm) Bergeon	EACH	£4.25

**Triangular Staking Punch**

Bergeon - Swiss Made

- Punch Ø4.7mm
- The last 3 digits of Bergeon 5285 \*\*\* is stamped on the original and replacement Punch

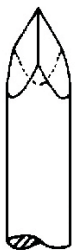

Code	Description	UOM	Price
P7638	294 (Ø2.00mm) Bergeon	EACH	£5.50
P7638A	295 (Ø4.00mm) Bergeon	EACH	£5.50

**Stake, Concave**

Bergeon - Swiss Made

- Bergeon 5285 -
- 314 (Ø3.00mm) Stake
- 315 (Ø5.00mm) Stake
- 316 (Ø7.00mm) Stake

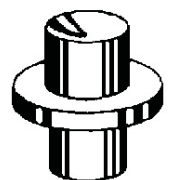

Code	Description	UOM	Price
P15261	314 (Ø3.00mm) Stake	EACH	£3.00
P31047	315 (Ø5.00mm) Stake	EACH	£3.00
P31048	316 (Ø7.00mm) Stake	EACH	£3.00

**Watchmakers Hammers**

See Page 911

## Stake, Domed Undrilled

Bergeon - Swiss Made

- Bergeon 5285 -  
 • 311 (Ø3.00mm) Stake  
 • 312 (Ø5.00mm) Stake

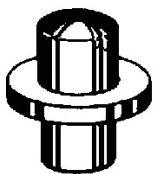

P7640C	302 (Ø4.00mm) Bergeon	EACH	£2.65
P7640D	303 (Ø5.00mm) Bergeon	EACH	£2.65
P7640E	304 (Ø7.00mm) Bergeon	EACH	£2.65
P7641	305 (Ø9.00mm) Bergeon	EACH	£2.65

## Stake, Flat Undrilled, Brass

Bergeon - Swiss Made

- Bergeon 5285 -  
 • 318 (Ø5.00mm) Bergeon

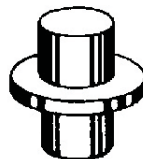

Code	Description	UOM	Price
P7645	318 (Ø5.00mm) Bergeon	EACH	£3.00

## Stake, Flat Drilled

Bergeon - Swiss Made

- Bergeon 5285 -  
 • 306 (Ø1.00 x Ø2.00mm) Bergeon  
 • 307 (Ø1.50 x Ø3.00mm) Bergeon  
 • 308 (Ø2.00 x Ø4.00mm) Bergeon  
 • 309 (Ø2.00 x Ø5.00mm) Bergeon  
 • 310 (Ø3.50 x Ø7.50mm) Bergeon  
 • Sizes: Hole Ø x Outer Ø

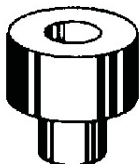

View our comprehensive selection of stones, with various grades, material types and shapes, there is a stone to cater for every shaping, grinding, sharpening and polishing requirements. Typically our customers who buy these stones are jewellers, silversmiths, engravers, clock and watch makers, model makers, those in arts and crafts, badge makers, engineers, traditional sword weapons makers, gunsmiths, leatherworkers, chefs, fishermen and wood workers.

All sorts of tools can and need to be sharpened, ground or polished with various stones; gravers, screwdrivers, knives, shears, drill bits, scoring tools, tweezers, virtually anything which needs to have a razor-sharp style edge.

The coarseness of a sharpening stone is defined by its grit rating; lower rated stones are coarse and higher rated stones are smooth. Properly sharpening tools involves three steps: grinding, sharpening and polishing. Grinding shapes your tool, but will leave large imperfections and nicks using a coarse stone. Using a medium grit stone, sharpening gives a tool a sharp new edge. Finishing polishes the tool and removes any small-scale surface imperfections when using a high grit sharpening stone.

- Arkansas stones – Ideal for sharpening your gravers. A jewellers/watchmakers favourite
- Bench stone: Most popular for shaping and sharpening
- Carborundum and Grindstones: Excellent grinding properties. Useful for when metal needs faster removal, also works well with taking down enamel

Code	Description	UOM	Price
P7641B	306 (Ø1.00 x Ø2.00mm) Bergeon	EACH	£2.75
P7641A	307 (Ø1.50 x Ø3.00mm) Bergeon	EACH	£2.75
P19768	308 (Ø2.00 x Ø4.00mm) Bergeon	EACH	£2.75
P31046	309 (Ø2.00 x Ø5.00mm) Bergeon	EACH	£2.75
P21958	310 (Ø3.50 x Ø7.50mm) Bergeon	EACH	£2.75

## Stake, Flat Drilled, Brass

Bergeon - Swiss Made

- Bergeon 5285 -  
 • 319 (Ø2.00mm x Ø7.00mm) Stake  
 • Sizes: Hole Ø x Outer Ø

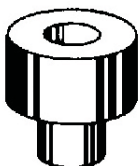

Code	Description	UOM	Price
P7646	319 (Ø2.00mm x Ø7.00mm) Stake	EACH	£2.75

## Stake, Flat Drilled, Split

Bergeon - Swiss Made

- Bergeon 5285 -  
 • 317 (Ø3.00 x Ø6.00mm) Bergeon  
 • Sizes: Hole Ø x Outer Ø

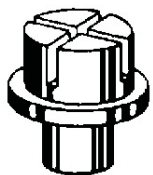

Code	Description	UOM	Price
P7644	317 (Ø3.00 x Ø6.00mm) Bergeon	EACH	£5.95

## Stake, Flat Undrilled

Bergeon - Swiss Made

- Bergeon 5285 -  
 • 300 (Ø2.00mm) Bergeon  
 • 301 (Ø3.00mm) Bergeon  
 • 302 (Ø4.00mm) Bergeon  
 • 303 (Ø5.00mm) Bergeon  
 • 304 (Ø7.00mm) Bergeon  
 • 305 (Ø9.00mm) Bergeon

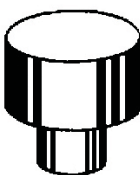

Code	Description	UOM	Price
P7640	300 (Ø2.00mm) Bergeon	EACH	£2.65
P7640A	301 (Ø3.00mm) Bergeon	EACH	£2.65

- Ceramic Stones: Perfect for polishing small and unreachable areas
- Degussit stones: High precision grinding used especially by watch makers
- Diamond stone: Very long lasting sharpening stone for gravers, blades etc.
- Stone jewellers/ watchmakers: An inexpensive all-rounder sharpening and polishing stone

Learning how to use a sharpening stone is integral in keeping your tools working like new. View our PDF below to see a full guide on how to use your stone to the best effect.

## Arkansas Stones



Natural "Genuine" Arkansas Sharpening Stones

The Arkansas sharpening stone is rated number one by engravers, stone setters, watch and clock makers, light engineers and wood workers to name just a few craftspeople who use these stones. Arkansas sharpening stones are suitable for sharpening all tool steel metals and are the most popular sharpening stone used worldwide.

Arkansas stones are quarried from geological formations of Novaculite and are composed of microcrystalline quartz. The unique crystalline structure of the quartz gives Arkansas stones their superior honing abilities.

Whether its gemstone setting, watch and clock making or creating an engraving masterpiece, Arkansas stones will provide the perfect cutting edge.

- Use 3 in 1 honing oil (Code O8690)
- Very fine abrasive papers or black touch stones are also available for polishing tools ultra bright see links below.

## Rectangle 50mm x 25mm in Box

- 50 x 25mm
- For fine finishing
- Supplied in wooden box



Code	Description	UOM	Price
S18530	Rectangle 50mm x 25mm in Box	EACH	£6.95

## Rectangle 90mm x 25mm in Box, German

- 90 x 25mm
- For fine finishing
- Supplied in wooden box



Code	Description	UOM	Price
S4450	Rectangle 90mm x 25mm in Box, German	EACH	£18.75

## Rectangle 100mm x 50mm in Box, German

- 100 x 50mm
- For fine finishing



• Supplied in wooden box

Code	Description	UOM	Price
S4451	Rectangle 100mm x 50mm in Box, German	EACH	£20.95

**Rectangle 150mm x 50mm, Bergeon Swiss**



• Bergeon 1951B  
• 150 x 50 x 25mm

Code	Description	UOM	Price
S2818	Rectangle 150mm x 50mm, Bergeon Swiss	EACH	£149.95

**Square 100 x 6 x 6mm, Bergeon Swiss**



• Bergeon 1952B  
• 100 x 6 x 6mm

Code	Description	UOM	Price
S6471	Square 100 x 6 x 6mm, Bergeon Swiss	EACH	£15.95

**Square 100 x 8 x 8mm, Bergeon Swiss**



• Bergeon 1952C  
• 100 x 8 x 8mm

Code	Description	UOM	Price
S4766	Square 100 x 8 x 8mm, Bergeon Swiss	EACH	£19.75

**Square 100 x 10 x 10mm, Bergeon Swiss**



• Bergeon 1952D  
• 100 x 10 x 10mm

Code	Description	UOM	Price
S1552	Square 100 x 10 x 10mm, Bergeon Swiss	EACH	£19.95

**Triangle 100 x 10 x 10mm, Bergeon Swiss**



• Bergeon 1953D  
• 100 x 10 x 10 x 10mm

Code	Description	UOM	Price
S1553	Triangle 100 x 10 x 10 x 10mm, Bergeon Swiss	EACH	£32.95

**Triangular Offcut, Variable Size**



• Arkansas stone style  
• Variable size

Code	Description	UOM	Price
S36106	Triangular Offcut, Variable Size	EACH	£7.50

**Arkansas Type Stones**



- Incredibly fine India stones
- Similar in grade to arkansas stone
- Give a similar finish to arkansas stones

**Square 100 x 6 x 6mm**



Code	Description	UOM	Price
S42912	Square 100 x 6 x 6mm	EACH	£3.50

**Square 100 x 8 x 8mm**



Code	Description	UOM	Price
S42913	Square 100 x 8 x 8mm	EACH	£3.75

**Square 100 x 10 x 10mm**



Code	Description	UOM	Price
S42914	Square 100 x 10 x 10mm	EACH	£3.95

**Triangle 100 x 10 x 10mm**



Code	Description	UOM	Price
S42915	Triangle 100 x 10 x 10mm	EACH	£3.95

**Bench Stones**



Norton Abrasives India oil stones, "sharp and quick"

Combination bench stones have been proven effective for all sharpening requirements, established in 1823 and were Americas first and oldest sharpening stone manufacturer. Pre-oiled the surface using 3 in 1 Honing Oil (code 8690) for the best results.

- After sharpening your gravers on a sharpening stone use a "Touch Stone" to achieve a mirror finish, a better way than using conventional abrasive paper than could rip.
- Use oil to obtain best results.
- Touch Stone: T20860

Norton, a manufacturer's profile: Sharpening stones for metal tools have been unearthed by Egyptian excavators dating back to 1450 BC. Our history is not so old, but when our pilgrim's forefathers landed in 1620 they soon discovered that they forgot to bring sharpening stones for their axes, knives and scythes. A crisis developed harvesting crops and wood for housing and heat became difficult, contributing to a very harsh first winter. It was a long wait for stones to be sent from Europe and search parties were sent to find suitable stone.

It was not until 1821, when Person Noyes, a New Hampshire pioneer stumbled along the finest deposit of mica schist in the world. Issac Pike soon followed and commercialized Person Noyes discovery in 1823 into what was to become the Pike Manufacturing Company. Worldwide distribution of Pike Sharpening Stones occurred as early as the mid 1800's.

In 1897 Norton Company and Pike Manufacturing Company joined forces satisfying the sharpening needs of the industrial revolution, the development of the safety razor, automation and every sharpening need known to man. Norton Pike has received citations from Admiral Bird upon return from his trip to the Antarctic and has received the Army-Navy production award for meeting production needs during World War II.

Since World War II, Norton Abrasives have established its brand in over sixty countries and also have found in India the same quality stones hence also known as the India Sharpening Stones, which to the present day Norton continue to mine and distribute sharpening stones for the demands of modern industry.

The technology that has evolved into the Combination Oil Stone is designed to satisfy the most exacting engraver, jeweller, watchmaker, clockmaker, model maker, toolmaker, mechanic, farmer, sportsman, wood worker, handyman and even kitchen chef, this product is highly effective for anyone's sharpening needs.

**Rectangle Aluminium Oxide Combination, Norton**

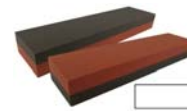

- 150 x 50 x 25mm
- Norton Superior Combination Stone
- Weight 320g

Combination stones are made with one face coarse

**PRICE PROMISE GUARANTEE**

and one face fine cut. The coarse face is used for sharpening dull tools, the fine for giving a keen lasting edge. Can be used dry or with oil.

Code	Description	UOM	Price
S4856	Rectangle Aluminium Oxide Combination, Norton	EACH	£24.40

## Rectangle General Purpose Combination, Norton

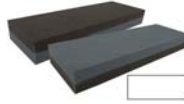

- 152 x 51 x 25mm
- Norton general Purpose combination
- Weight 500g

Combination stones are made with one face coarse and one face fine cut.

The coarse face is used for sharpening dull tools, the fine for giving a keen lasting edge. Can be used dry or with oil.

Code	Description	UOM	Price
S4857	Rectangle General Purpose Combination, Norton	EACH	£7.25

## Rectangle India Stone 150 x 50 x 25mm, Indian



Code	Description	UOM	Price
S39028	Rectangle India Stone 150 x 50 x 25mm, Indian	EACH	£9.95

## Square India Stone 100 x 10 x 10mm, Bergeon



- Bergeon Swiss 1945.34M
- India Stone Square - Medium Grain
- 100 x 10 x 10mm
- Weight 25g

Code	Description	UOM	Price
S1557	Square India Stone 100 x 10 x 10mm, Bergeon	EACH	£15.95

## Square India Stone 150 x 15 x 15mm, Bergeon



- Bergeon Swiss 1945.56M
- India Stone Square 150 x 15 x 15mm
- Medium Grain
- Weight 90g

Code	Description	UOM	Price
S1558	Square India Stone 150 x 15 x 15mm, Bergeon	EACH	£29.95

## Square India Stone 175 x 15 x 15mm



- for Wooden Base Item: S31323

Code	Description	UOM	Price
S33501	Square India Stone 175 x 15 x 15mm	EACH	£2.35

## Square India Stone on Wooden Base, Bergeon



- Bergeon 4712
- Base: 200 x 55 x 30mm
- Stone: 150 x 15 x 15mm (replacement ref: S1558)
- Weight 300g

Bergeon screwdriver/graver sharpening stone on wooden base. This is a traditional economical watchmaker's sharpening stone on a wooden base. This tool is ideally used to re-sharpen watchmaker's screwdrivers and square and lozenge gravers with precision and accuracy.

To achieve perfect angles on the tools place the graver or watchmaker's screwdriver into the sharpening tools holders (Please see links below). These tools can be set at the optimum angle for gravers and watchmaker's screwdrivers.

The sharpening stone is set into the wooden base allowing the easy fluctuation of the sharpening tool holder giving the user better control when sharpening.

Code	Description	UOM	Price
S4868	Square India Stone on Wooden Base, Bergeon	EACH	£63.95

## Square India Stone on Wooden Base, Indian



- Non Swiss
- Base: 210 x 50 x 22mm
- Stone: 175 x 15 x 15mm (replacement ref: S33501)
- Weight 225g

Economy screwdriver/graver sharpening stone on wooden base. This is a traditional economical watchmaker's sharpening stone on a wooden base. This tool is ideally used to re-sharpen watchmaker's screwdrivers and square and lozenge gravers with precision and accuracy.

To achieve perfect angles on the tools place the graver or watchmaker's screwdriver into the sharpening tools holders (Please see links below). These tools can be set at the optimum angle for gravers and watchmaker's screwdrivers.

The sharpening stone is set into the wooden base allowing the easy fluctuation of the sharpening tool holder giving the user better control when sharpening.

Code	Description	UOM	Price
S31323	Square India Stone on Wooden Base, Indian	EACH	£8.95

## Screwdriver Sharpener

See Page 1000



## Polishing Abrasive Paper

See Page 1145



## Carborundum Stones



Count on Carborundum Stones for better abrasive, grinding, shaping, smoothing, deburring, edging, filing, sharpening and finishing needs.

Carborundum is one of the most appreciated stone abrasives in industry. We offer a comprehensive range featuring various shapes for both performance and value / price. A Carborundum Stone is made from silicone dioxide minerals that are mined and separated into soft, medium or hard grade stones with fine, medium and coarse surfaces.

- These stones excellent cutting capability enables the easy removal of excess enamel
- Complete the shaping on engraving tools to achieve the best quality finish on tools
- Removes sharp edges created during scoring and breaking. Ensure the stone is kept wet when in use to eliminate glass particles from the air
- Grind and smooth excess down excess solder after completing joins
- The Carborundum Stone is perfect for removing plating on checking for filling when gold buying
- Use with 3 in 1 Honing oil (code 8690) oil for the best results.

## Half Round (Ø13 x 100mm) Stone

- Coarse cut
- Abrasive half round section
- Grinding slip stone in a handy stick form



Code	Description	UOM	Price
S9840	Half Round (Ø13 x 100mm) Stone	EACH	£2.15

## Rectangular (75 x 22 x 10mm) Stone

- Small stone. 75 x 22 x 10mm
- Combination: coarse and medium



Code	Description	UOM	Price
S39029	Rectangular (75 x 22 x 10mm) Stone	EACH	£2.75

## Rectangular (100 x 45 x 15mm) Stone

- Small stone. 100 x 45 x 15mm
- Combination: coarse and medium



Code	Description	UOM	Price
S4746	Rectangular (100 x 45 x 15mm) Stone	EACH	£5.50

**Rectangular (125 x 50 x 20mm) Stone**

- 125 x 50 x 20mm
- Combination: coarse and medium



Code	Description	UOM	Price
S39030	Rectangular (125 x 50 x 20mm) Stone	EACH	£6.50

**Rectangular (150 x 50 x 25mm) Stone**

- 150 x 50 x 25mm
- Combination: coarse and medium



Code	Description	UOM	Price
S39031	Rectangular (150 x 50 x 25mm) Stone	EACH	£6.95

**Round (Ø13 x 100mm) Stone**

- Medium cut
- Abrasive round section
- Grinding slip stone in a handy stick form



Code	Description	UOM	Price
S9841	Round (Ø13 x 100mm) Stone	EACH	£2.15

**Square (10 x 10 x 100mm) Stone**

- Medium cut
- Abrasive square section
- Grinding slip stone in a handy stick form



Code	Description	UOM	Price
S9838	Square (10 x 10 x 100mm) Stone	EACH	£1.55

**Triangular (14 x 14 x 14 x 100mm) Stone**

- Medium cut
- Abrasive triangular section
- Grinding slip stone in a handy stick form.



Code	Description	UOM	Price
S9839	Triangular (14 x 14 x 14 x 100mm) Stone	EACH	£2.15

**Ceramic Stones, Vallorbe Swiss**



**Ceramic Stones - Vallorbe Swiss**

These miniature tools are the perfect solution for deburring or polishing the smallest, most unreachable areas, including jewellery mounts and watch bracelets for instance.

Made of new composite material encompassing ceramic fibres in a very hard thermoset resin, which is virtually unbreakable, they have a long service life. Fully usable, they do not break, crack or burr. The point can be shaped to match the target area using a wheel or any other diamond-coated tool. Flexible and resilient, Vallorbe ceramic fibre files do not leave a single scratch on the work piece because the tool does not form any abrasive particles, enabling a uniform finish.

- Pillar, round or square shape
- 180 (extra, extra coarse) to 3000 (extra, extra fine) grit available (the higher the grit, the finer the stone)
- Multiple sizes & grits
- Use and finish by hand with our comfortable hand-held pen stone holders
- These holders will insure that the handling is easy and your work will be completely accurate
- A favourite with platinum, gold and silver mounters in the Jewellery/watch making industry
- Uniform surface finish
- Enhanced service life
- The ultimate in high class finishing for your products
- Vallorbe Swiss

**Dimensions:**

- Shape (size), grit

**Grit value examples:**

- 180 grit: For removing uneven metal casting mark flash marks, scratches etc.
- 300 grit: Smoothing/levelling the metal
- 800 grit: Semi shine lustre look
- 1200 grit: Polished finish
- 3000 grit: Super high lustre, mirror polish finish

**Stone lengths:**

- Pillar (all sizes): 100mm
- Round (all sizes): 50mm
- Square (0.50 & 0.90mm): 50mm
- Square (1.00mm): 100mm

Code	Description	UOM	Price
S48919	Stone Holder, Pillar (2mm)	EACH	£7.95
S48920	Stone Holder, Pillar (4mm)	EACH	£9.95
S48917	Stone Holder, Round (Ø2.34mm)	EACH	£9.95
S48918	Stone Holder, Round (Ø3.00mm)	EACH	£9.95
P35556	Stone Holder, Square (0.50mm)	EACH	£8.65
P35561	Stone Holder, Square (0.90mm)	EACH	£8.95
S48916	Stone Holder, Square (1.00mm)	EACH	£9.95
S48857	Pillar (2.00 x 0.50mm), 300 Grit	EACH	£7.35
S48858	Pillar (2.00 x 0.50mm), 400 Grit	EACH	£7.35
S48859	Pillar (2.00 x 0.50mm), 600 Grit	EACH	£7.35
S48860	Pillar (2.00 x 0.50mm), 800 Grit	EACH	£7.35
S48861	Pillar (2.00 x 0.50mm), 1000 Grit	EACH	£7.35
S48862	Pillar (2.00 x 0.50mm), 1200 Grit	EACH	£7.35
S48863	Pillar (2.00 x 1.00mm), 120 Grit	EACH	£7.35
S48864	Pillar (2.00 x 1.00mm), 220 Grit	EACH	£7.35
S48865	Pillar (2.00 x 1.00mm), 300 Grit	EACH	£7.35
S48866	Pillar (2.00 x 1.00mm), 400 Grit	EACH	£7.35
S48867	Pillar (2.00 x 1.00mm), 600 Grit	EACH	£7.35
S48868	Pillar (2.00 x 1.00mm), 800 Grit	EACH	£7.35
S48869	Pillar (2.00 x 1.00mm), 1000 Grit	EACH	£7.35
S48870	Pillar (2.00 x 1.00mm), 1200 Grit	EACH	£7.35
S48871	Pillar (2.00 x 1.00mm), 1500 Grit	EACH	£7.35
S48872	Pillar (2.00 x 1.00mm), 2000 Grit	EACH	£9.70
S48873	Pillar (2.00 x 1.00mm), 3000 Grit	EACH	£9.70
S48874	Pillar (4.00 x 0.50mm), 220 Grit	EACH	£16.55
S48875	Pillar (4.00 x 0.50mm), 300 Grit	EACH	£16.55
S48876	Pillar (4.00 x 0.50mm), 400 Grit	EACH	£15.95
S48877	Pillar (4.00 x 0.50mm), 600 Grit	EACH	£15.95
S48878	Pillar (4.00 x 0.50mm), 800 Grit	EACH	£15.95
S48879	Pillar (4.00 x 0.50mm), 1000 Grit	EACH	£15.95
S48880	Pillar (4.00 x 0.50mm), 1200 Grit	EACH	£15.95
S48881	Pillar (4.00 x 1.00mm), 120 Grit	EACH	£14.15
S48882	Pillar (4.00 x 1.00mm), 220 Grit	EACH	£14.15
S48883	Pillar (4.00 x 1.00mm), 300 Grit	EACH	£14.15
S48884	Pillar (4.00 x 1.00mm), 400 Grit	EACH	£12.75
S48885	Pillar (4.00 x 1.00mm), 600 Grit	EACH	£12.75
S48886	Pillar (4.00 x 1.00mm), 800 Grit	EACH	£12.75
S48887	Pillar (4.00 x 1.00mm), 1000 Grit	EACH	£12.75
S48888	Pillar (4.00 x 1.00mm), 1200 Grit	EACH	£12.75
S48889	Pillar (4.00 x 1.00mm), 1500 Grit	EACH	£12.75
S48890	Round (Ø2.34mm), 220 Grit	EACH	£13.25

**Degussit Stones**



Degussit stones are used for fine grinding, polishing and deburring. Particular economical advantages are obtained when working with hardened steel, glass and porcelain and are loved by watchmakers, clockmakers and jewellers for their pin point sharpness and their long lasting hardness.

Cousins stock a variety of shapes and grits of Degussit stone which naturally comprises a very fine surface obtained by diamond grinding and is used for the finest precision work. Degussit fine grinding stones consist of a mixed crystal of exceptional hardness resulting in high wear resistance and excellent shape stability; the main element is aluminium oxide. The characteristic red colour of the tools is the result of an admixture of chromium oxide. This crystal is found in nature as ruby - hence the material is sometimes known as 'sintered ruby'.

- Available in fine, medium and coarse grits:
  - Fine has a very fine surface obtained by diamond grinding and is used for the finest precision work
  - Medium has a better grip for slightly tougher jobs
  - Coarse is roughened by silicon carbide powder. Only whetstones and abrasive files are similar in comparison
- Exceptionally hard (second only to diamond) and will cut and polish steel and many other tough metals.
- Bond free and incredibly long lasting
- Will keep shape and is brilliantly wear resistant offering an economical advantage as it will not need to be replaced in a hurry
- Can be used in awkward or intricate areas, proving a vital tool for many watch and clock makers
- Sharp and crisp edges for ease and accuracy of use, ensuring work is carried out to the highest of precision

- Used by the clock and watchmaker on lathes, clock pivots and much, much more
- A wide variety of shapes and sizes to suit any job
- All our Degussit stones are manufactured in Europe, ensuring only the best quality natural resource

Application areas for Degussit fine grinding stones:

- Degussit stones are used for the manufacture of cutting, stamping, bending and pressing tools as well as for the sharpening and deburring of all kinds of tools.
- Tool and die manufacturers
- Fine mechanics and the watch industry
- Degussit fine grinding stones are needed in the watch, sewing machine, office machine, and photograph and instrument industry for the following purposes: Fine grinding, deburring, adjusting, smoothing, and polishing.
- In the porcelain industry, Degussit stones are used for grinding off soiling and defects. Brims of plates and cups are finished with Degussit fine grinding stones.

## Flat (Coarse), 6 x 8 x 100mm

- Degussit
- Long Service Life
  - Outstanding Surface Finish
  - Dimensions: Height x Width x Length



Code	Description	UOM	Price
S36068	Flat (Coarse), 6 x 8 x 100mm	EACH	£43.75

## Square (Coarse), 6 x 6 x 100mm

- Degussit
- Long Service Life
  - Outstanding Surface Finish
  - Dimensions: Height x Width x Length



Code	Description	UOM	Price
S36065	Square (Coarse), 6 x 6 x 100mm	EACH	£39.70

## Half Round (Medium), Ø10 x 100mm

- Degussit
- Long Service Life
  - Outstanding Surface Finish
  - Dimensions: Diameter x Length



Code	Description	UOM	Price
S36069	Half Round (Medium), Ø10 x 100mm	EACH	£54.80

## Tapered (Fine), Ø2 to Ø5 x 100mm

- Degussit
- Long Service Life
  - Outstanding Surface Finish
  - Dimensions: Diameter x Diameter x Length



Code	Description	UOM	Price
S36070	Tapered (Fine), Ø2 to Ø5 x 100mm	EACH	£40.40

## Benchstone (Fine), 10 x 25 x 100mm

- Degussit
- Long Service Life
  - Outstanding Surface Finish
  - Dimensions: Height x Width x Length



Code	Description	UOM	Price
S36058	Benchstone (Fine), 10 x 25 x 100mm	EACH	£81.65

## Benchstone (Medium), 10 x 25 x 100mm

- Degussit
- Long Service Life
  - Outstanding Surface Finish
  - Dimensions: Height x Width x Length



Code	Description	UOM	Price
S36059	Benchstone (Medium), 10 x 25 x 100mm	EACH	£70.50

## Flat (Fine), 6 x 8 x 100mm

- Degussit
- Long Service Life
  - Outstanding Surface Finish
  - Dimensions: Height x Width x Length



Code	Description	UOM	Price
S36066	Flat (Fine), 6 x 8 x 100mm	EACH	£53.85

## Flat (Medium), 6 x 8 x 100mm

- Degussit
- Long Service Life
  - Outstanding Surface Finish
  - Dimensions: Height x Width x Length



Code	Description	UOM	Price
S36067	Flat (Medium), 6 x 8 x 100mm	EACH	£49.95

## Half Round (Coarse), Ø10 x 100mm

- Degussit
- Long Service Life
  - Outstanding Surface Finish
  - Dimensions: Diameter x Length



Code	Description	UOM	Price
S1556	Half Round (Coarse), Ø10 x 100mm	EACH	£48.35

## Lozange (Coarse), 5 x 13 x 100mm

- Degussit
- Long Service Life
  - Outstanding Surface Finish
  - Dimensions: Height x Width x Length



Code	Description	UOM	Price
S1554	Lozange (Coarse), 5 x 13 x 100mm	EACH	£59.10

## Square (Fine), 6 x 6 x 100mm

- Degussit
- Long Service Life
  - Outstanding Surface Finish
  - Dimensions: Height x Width x Length



Code	Description	UOM	Price
S36063	Square (Fine), 6 x 6 x 100mm	EACH	£53.50

## Square (Medium), 6 x 6 x 100mm

- Degussit
- Long Service Life
  - Outstanding Surface Finish
  - Dimensions: Height x Width x Length



Code	Description	UOM	Price
S36064	Square (Medium), 6 x 6 x 100mm	EACH	£49.50

## Tapered (Coarse), Ø2.00 to Ø5.00 x 100mm

- Degussit
- Long Service Life
  - Outstanding Surface Finish
  - Dimensions: Diameter x Diameter x Length



Code	Description	UOM	Price
S1555	Tapered (Coarse), Ø2.00 to Ø5.00 x 100mm	EACH	£39.70

## Triangular (Fine), 6 x 6 x 100mm

- Degussit
- Long Service Life
  - Outstanding Surface Finish
  - Dimensions: Height x Width x Length



Code	Description	UOM	Price
S36060	Triangular (Fine), 6 x 6 x 100mm	EACH	£43.50

## Triangular (Medium), 6 x 6 x 100mm

- Degussit
- Long Service Life
  - Outstanding Surface Finish
  - Dimensions: Height x Width x Length



Code	Description	UOM	Price
S36061	Triangular (Medium), 6 x 6 x 100mm	EACH	£40.50

Graver Holders for Sharpening

See Page 903



**Triangular (Coarse),  
6 x 6 x 100mm**

- Degussit
- Long Service Life
  - Outstanding Surface Finish
  - Dimensions: Height x Width x Length



Code	Description	UOM	Price
S36062	Triangular (Coarse), 6 x 6 x 100mm	EACH	£39.95

**Degussit Stones, Midget**



Degussit stones are used for fine grinding, polishing and deburring. Particular economical advantages are obtained when working with hardened steel, glass and porcelain and are loved by watchmakers, clockmakers and jewellers for their pin point sharpness and their long lasting hardness.

Cousins stock a variety of shapes of midget Degussit stones, only available in fine grit, which naturally comprises a very fine surface obtained by diamond grinding and is used for the finest precision work. Degussit fine grinding stones consist of a mixed crystal of exceptional hardness resulting in high wear resistance and excellent shape stability; the main element is aluminium oxide. The characteristic red colour of the tools is the result of an admixture of chromium oxide. This crystal is found in nature as ruby - hence the material is sometimes known as 'sintered ruby'.

- Available only in fine grit
- Exceptionally hard (second only to diamond) and will cut and polish steel and many other tough metals.
- Bond free and incredibly long lasting
- Will keep shape and is brilliantly wear resistant offering an economical advantage as it will not need to be replaced in a hurry
- Can be used in awkward or intricate areas, proving a vital tool for many watch and clock makers
- Sharp and crisp edges for ease and accuracy of use, ensuring work is carried out to the highest of precision
- Used by the clock and watchmaker on lathes, clock pivots and much, much more
- A wide variety of shapes and sizes to suit any job
- All our Degussit stones are manufactured in Europe, ensuring only the best quality natural resource

Application areas for Degussit fine grinding stones:

- Degussit stones are used for the manufacture of cutting, stamping, bending and pressing tools as well as for the sharpening and deburring of all kinds of tools
- Fine mechanics and the watch industry
- Tool and die manufacturers
- Degussit fine grinding stones are needed in the watch, sewing machine, office machine, and photograph and instrument industry for the following purposes: Fine grinding, deburring, adjusting, smoothing, and polishing
- In the porcelain industry, Degussit stones are used for grinding off soiling and defects. Brims of plates and cups are finished with Degussit fine grinding stones

**Barrette, 1.5 x 5 x 100mm**

- Degussit
- Long Service Life
  - Outstanding Surface Finish
  - Dimensions: Height x Width x Length



Code	Description	UOM	Price
S35893	Barrette, 1.5 x 5 x 100mm	EACH	£19.95

**Crossing, 1.50 x 4 x 100mm**

- Degussit
- Long Service Life
  - Outstanding Surface Finish
  - Dimensions: Height x Width x Length



Code	Description	UOM	Price
S35894	Crossing, 1.50 x 4 x 100mm	EACH	£18.75

**Flat, 0.3 x 3 x 50mm,**

- Degussit
- Long Service Life
  - Outstanding Surface Finish
  - Dimensions: Height x Width x Length



Code	Description	UOM	Price
S35891	Flat, 0.3 x 3 x 50mm,	EACH	£6.95

**Half Round, Ø4.00 x 100mm**

- Degussit
- Long Service Life
  - Outstanding Surface Finish
  - Dimensions: Diameter x Length



Code	Description	UOM	Price
S35892	Half Round, Ø4.00 x 100mm	EACH	£18.75

**Round, Ø1 x 50mm**

- Degussit
- Long Service Life
  - Outstanding Surface Finish
  - Dimensions: Diameter x Length



Code	Description	UOM	Price
S35888	Round, Ø1 x 50mm	EACH	£4.35

**Round, Ø2 x 100mm**

- Degussit
- Long Service Life
  - Outstanding Surface Finish
  - Dimensions: Diameter x Length



Code	Description	UOM	Price
S35889	Round, Ø2 x 100mm	EACH	£11.95

**Round, Ø3 x 100mm**

- Degussit
- Long Service Life
  - Outstanding Surface Finish
  - Dimensions: Diameter x Length



Code	Description	UOM	Price
S35890	Round, Ø3 x 100mm	EACH	£11.95

**Square, 1 x 1 x 50mm**

- Degussit
- Long Service Life
  - Outstanding Surface Finish
  - Dimensions: Height x Width x Length



Code	Description	UOM	Price
S35884	Square, 1 x 1 x 50mm	EACH	£4.35

**Square, 2 x 2 x 100mm**

- Degussit
- Long Service Life
  - Outstanding Surface Finish
  - Dimensions: Height x Width x Length



Code	Description	UOM	Price
S35885	Square, 2 x 2 x 100mm	EACH	£11.95

**Triangle, 2 x 2 x 50mm**

- Degussit
- Long Service Life
  - Outstanding Surface Finish
  - Dimensions: Height x Width x Length



Code	Description	UOM	Price
S35886	Triangle, 2 x 2 x 50mm	EACH	£5.65



**+ Contact & Services** Your direct line to our **Management Team**



**Triangle, 3 x 3 x 100mm**



- Degussit
- Long Service Life
  - Outstanding Surface Finish
  - Dimensions: Height x Width x Length

Code	Description	UOM	Price
S35887	Triangle, 3 x 3 x 100mm	EACH	£18.75

**Diamond Stone**



DMT Diamond stone has been a market leader for over 30 years.

This is a continuous monocrystalline, diamond surface sharpener, preferred when sharpening small-pointed tools and can be used for engraving tools, screwdriver blades, knives, tool sharpening, honing and deburring as well.

- This diamond stone avoids snagging small and pointed tools during sharpening
- Fast- sharpens in a fraction of the time required by other methods.
- Only light pressure is needed when using this tool.
- Easy – just a few easy strokes sharpens even the toughest metal carbides and ceramics
- Clean- no messy oils or clean up- use only water if needed.
- Durable- long lasting and highest quality sharpener on the market.
- It will not hollow or groove over the life of the product
- Polishes and refines to a razor edge
- One sided 150mm x 50mm with Diamond Imprecation
- See PDF for DMT care and user manual

Size and Weight:

- Plate size: 150 x 50 x 6mm
- Weight: 415g

Grits:

- Extra fine (green): Grade 1200, 9 micron
- Fine (red): Grade 600, 25 micron
- Coarse (blue): Grade 325, 45 micron
- Extra coarse (black): Grade 220, 60 micron

Code	Description	UOM	Price
S48975	Extra Fine Diamond Sharpening Lap Stone	EACH	£28.95
D33152	Diamond Sharpening Lap Stone	EACH	£28.95
S48976	Coarse Diamond Sharpening Lap Stone	EACH	£28.95
S48977	Extra Coarse Diamond Sharpening Lap Stone	EACH	£28.95

**PRICE PROMISE GUARANTEE**

**Vallorbe Swiss Gravers**

**See Page 904**

**Jewellers Stone**

Sharpening & Polishing Stone - Jewellers & Watchmakers

- This is an exceptional value ceramic sharpening stone
- Great value and a keen price
- Fine or extra fine
- For a high quality mirror finish and razor shape gravers and scorpers
- Use with a fine 3 in 1 oil (Item: O8691) to give a smooth clean slide feel
- Size: 5¼ x 1½" inch
- Red or green colour
- Weight: 120g

**Fine Grade Sharpening & Polishing Stone**



- This is an exceptional value Ceramic Sharpening Stone. Great value and a keen Price
- For jewellers & watchmakers
- For a high quality mirror finish and razor shape gravers and scorpers
- Use with a fine 3 in 1 oil (Item O8691) to give a smooth clean slide feel
- Size: 5¼ x 1½" inch
- Red colour
- Weight: 120g

Code	Description	UOM	Price
S20878	Fine Grade Sharpening & Polishing Stone	EACH	£3.15

**Extra Fine Grade Sharpening & Polishing Stone**



- This is an exceptional value Ceramic Sharpening Stone. Great value and a keen Price
- For jewellers & watchmakers
- For a high quality mirror finish and razor shape gravers and scorpers
- Use with a fine 3 in 1 oil (Item O8691) to give a smooth clean slide feel
- Size: 5¼ x 1½" inch
- Green colour
- Weight: 120g

Code	Description	UOM	Price
S47819	Extra Fine Grade Sharpening & Polishing Stone	EACH	£3.95

**www. Online Discounts**

**Scraper Tools**

**See Page 905**

**STONE SETTING**

**BEADING TOOLS, GRAINERS & FION PLATE**

**Grainer Pliers**

**COUSINSUK**



These bead setting pliers will replace the common grainers on a great many jobs as they are so much easier to use! No longer will you need to hold items in the ring clamp and on a bench pin, or fill a fragile item with shellac. Can be used to hold stones (culet to table) while being heat set into wax models. This tool will give you the support from the underside you need to do common, everyday tightening and setting in stones, plus many other applications.

- One bead forming jaw & one support jaw
- Ø1.00mm beading jaw
- Easily make bead patterns on the inside of rings
- Spring loaded (double leaf springs)
- Stainless steel
- PVC coated handles
- Overall length 135mm
- Cousins Swiss Style
- Superb Swiss style quality

Code	Description	UOM	Price
P48638	Grainer Pliers	EACH	£9.95

**Grainers by Size**

**VALUE**



Bead Patterning: For producing a sphere / ball shape final finish to the end of the grain setting and also for creating decorative miniature ball patterns & wire end rounding.

- Length 60mm
- External Ø2.60mm
- Internal Ø listed plus the tool number
- Made in China

Beading tools are essential traditional tools for stone settings:

- The final procedure to secure and perfectly finish diamond / gemstone settings after grain setting
- To pattern miniature balls for decoration on wedding rings and bangles etc

- All beading tools are made from hardened polished steel
- Full range of sizes are available, particularly for pave settings
- Each graining tool is numbered so they are easily identifiable

Code	Description	UOM	Price
B40185	No.1 (Ø0.30mm) Beading Tool	EACH	£0.65
B40186	No.2 (Ø0.35mm) Beading Tool	EACH	£0.65
B40187	No.3 (Ø0.40mm) Beading Tool	EACH	£0.65
B40188	No.4 (Ø0.45mm) Beading Tool	EACH	£0.65
B40189	No.5 (Ø0.50mm) Beading Tool	EACH	£0.65
B40190	No.6 (Ø0.55mm) Beading Tool	EACH	£0.65
B40191	No.7 (Ø0.60mm) Beading Tool	EACH	£0.65
B40192	No.8 (Ø0.65mm) Beading Tool	EACH	£0.65
B40193	No.9 (Ø0.70mm) Beading Tool	EACH	£0.65
B40194	No.10 (Ø0.75mm) Beading Tool	EACH	£0.65
B40195	No.11 (Ø0.80mm) Beading Tool	EACH	£0.65
B40196	No.12 (Ø0.85mm) Beading Tool	EACH	£0.65
B40197	No.13 (Ø0.90mm) Beading Tool	EACH	£0.65
B40198	No.14 (Ø0.95mm) Beading Tool	EACH	£0.65
B40199	No.15 (Ø1.00mm) Beading Tool	EACH	£0.65
B40200	No.16 (Ø1.05mm) Beading Tool	EACH	£0.65
B40201	No.17 (Ø1.10mm) Beading Tool	EACH	£0.65
B40202	No.18 (Ø1.15mm) Beading Tool	EACH	£0.65
B40203	No.19 (Ø1.20mm) Beading Tool	EACH	£0.65
B40204	No.20 (Ø1.25mm) Beading Tool	EACH	£0.65
B40205	No.21 (Ø1.30mm) Beading Tool	EACH	£0.65
B40206	No.22 (Ø1.35mm) Beading Tool	EACH	£0.65

**Grainers by Size, A\*F Swiss**



Bead Patterning: For producing a sphere / ball shape final finish to the end of the grain setting and also for creating decorative miniature ball patterns & wire end rounding.

Individuals:

- A\*F Switzerland
- Length 60mm
- External Ø2.60mm
- Internal Ø listed plus the tool number

Beading tools are essential traditional tools for stone settings.

- The final procedure to secure and perfectly finish diamond / gemstone settings after grain setting
- To pattern miniature balls for decoration on wedding rings and bangles etc
- All beading tools are made from hardened polished steel
- Full range of sizes are available, particularly for pave settings
- Each graining tool is numbered so they are easily identifiable

Code	Description	UOM	Price
B4461	No.0 (Ø0.25mm) Beading Tool	EACH	£0.95
B4462	No.1 (Ø0.30mm) Beading Tool	EACH	£0.95
B4463	No.2 (Ø0.35mm) Beading Tool	EACH	£0.95
B4464	No.3 (Ø0.40mm) Beading Tool	EACH	£0.95
B4465	No.4 (Ø0.45mm) Beading Tool	EACH	£0.95
B4466	No.5 (Ø0.50mm) Beading Tool	EACH	£0.95
B4467	No.6 (Ø0.55mm) Beading Tool	EACH	£0.95
B4468	No.7 (Ø0.60mm) Beading Tool	EACH	£0.95
B4469	No.8 (Ø0.65mm) Beading Tool	EACH	£0.95
B4470	No.9 (Ø0.70mm) Beading Tool	EACH	£0.95
B4471	No.10 (Ø0.75mm) Beading Tool	EACH	£0.95
B4472	No.11 (Ø0.80mm) Beading Tool	EACH	£0.95

B4473	No.12 (Ø0.85mm) Beading Tool	EACH	£0.95
B4474	No.13 (Ø0.90mm) Beading Tool	EACH	£0.95
B4475	No.14 (Ø0.95mm) Beading Tool	EACH	£0.95
B4476	No.15 (Ø1.00mm) Beading Tool	EACH	£0.95
B4477	No.16 (Ø1.05mm) Beading Tool	EACH	£0.95
B4478	No.17 (Ø1.10mm) Beading Tool	EACH	£0.95
B4479	No.18 (Ø1.15mm) Beading Tool	EACH	£0.95
B4480	No.19 (Ø1.20mm) Beading Tool	EACH	£0.95
B4481	No.20 (Ø1.25mm) Beading Tool	EACH	£0.95

**Grainers Sets**

Bead Patterning: For producing a sphere / ball shape final finish to the end of the grain setting and also for creating decorative miniature ball patterns & wire end rounding.

Beading tools are essential traditional tools for stone settings.

- The final procedure to secure and perfectly finish diamond / gemstone settings after grain setting
- To pattern miniature balls for decoration on wedding rings and bangles etc
- All beading tools are made from hardened polished steel
- Full range of sizes are available, particularly for pave settings
- Each graining tool is numbered so they are easily identifiable
- Stand available, code S39270

**Beading / Grainer Tool Set of 12, A\*F Swiss**



- A\*F Swiss 139.120
- Set of 12
- On Stand with wooden handle
- Contains numbers 2, 4, 6, 7, 8, 9, 10, 11, 12, 13, 14 & 16
- Length 60mm
- External Ø2.60mm
- Internal Ø listed next to tool number

Code	Description	UOM	Price
B4460	Beading / Grainer Tool Set of 12, A*F Swiss	PACK*12	£18.50

**Beading / Grainer Tool Set of 23, Cousins**



- Cousins UK European manufactured grainer set
- Set of 23 pieces
- On stand with wooden handle
- Contains numbers 0 to 22
- Length 60mm
- External Ø2.6mm
- Internal diameter stamped on tool

Code	Description	UOM	Price
B35290	Beading / Grainer Tool Set of 23, Cousins	PACK*23	£12.95

**Wooden Handles**

See Page 916



**Beading / Grainer Tool Set of 12, Indian**



with wooden handle with screw collet fixing

- Set of 12 pieces
- On stand with wooden handle
- Contains numbers 1 to 12
- Length 60mm
- External Ø2.60mm
- Supplied with 2 collets
- Made in India

Code	Description	UOM	Price
S39269	Beading / Grainer Tool Set of 12, Indian	PACK*12	£4.95

**Beading / Grainer Tool Set of 16, Indian**



- Set of 16 pieces
- On stand with wooden handle
- Contains numbers 1 to 16
- Length 60mm
- External Ø1.20mm
- Made in India

Code	Description	UOM	Price
B41494	Beading / Grainer Tool Set of 16, Indian	PACK*16	£6.95

**Grainers Stand**

- 24 holes for grainers
- Hole diameter Ø2.90mm
- Centre hole diameter Ø33mm
- Can be used for sets B4460, B35290 & S39269



Code	Description	UOM	Price
S39270	Grainer Stand	EACH	£1.95

OVER 130,000 DIFFERENT ITEMS

**Pattern Former Mini Mill**

See Page 727



**Fion Plates**

Fion plates are used to sharpen and polish you're beading / graining tools to a high finish.

- Consists of various ball ended hard steel sized cones
- Each corresponds in size to one of the beading/grain tools
- Transfer a highly polished finish onto the stone setting such as pave settings
- Gently move your beading tool in a pivotal motion to shape and polish
- Hold in a traditional wooden grainer handle

**12 Sizes, Fion Plate, Indian**

- Hardened steel points numbered 1 to 12
- Numbered 1 to 12
- Made in India



Code	Description	UOM	Price
B35080	12 Sizes, Fion Plate, Indian	EACH	£14.95

**48 Sizes, Fion Plate, A\*F Swiss**

- High quality
- Made with the intention for use by the top diamond setters in the trade
- Highly polished points giving the very best grain rounding finish
- The one you need for the high gemstone pave a setting
- Hardened and tempered



Code	Description	UOM	Price
B13750	48 Sizes, Fion Plate, A*F Swiss	EACH	£75.50

**MILLGRAIN WHEELS**

A Millgrain wheel is a petite, decorated wheel that leaves a trail of miniature balls when rolled along a sharp edge of metal.

- Give customers a traditional craftsperson touch
- The Millgrain effect is a very popular method for decoration especially on wedding rings and bangles
- Our range of Millgrain wheels are made from carbon steel and are of the female 'raise effect' which leaves an indented pattern
- Can be used both in a hand tool and on a lathe
- Cousins also supply beading tools which will create the same effect but the pattern would be completed one stage at a time opposed to the advantageous roller motion created by the millgrain wheel (please see the illustration)
- A millgrain wheel is a perfect time saver, allowing you to form a train pattern in a fraction of the time it would take with a graver

**Millgrain Wheels**

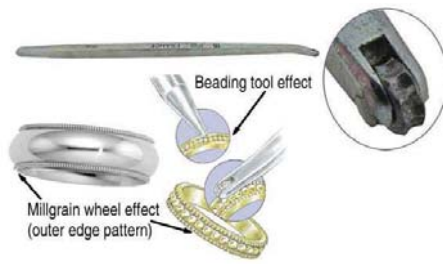

- A\*F Swiss or unbranded
- Made in France or China
- Length: 70mm
- Thickness of body 2.50 x 2.50mm
- Full range of sizes, in stock, number 0 to 15

The difference between size 0, which measures approximately 0.33mm across, and the largest size 15, which measures approximately 0.62mm, is only 0.29mm. That makes the difference between the sizes approximately 0.02mm. (We say approximately because they are so difficult to measure.) Mill grain tools are marked with a size number from 00 through 15 to help with identification.

- Sizes:
- 00 = 0.31mm
  - 0 = 0.33mm
  - 1 = 0.35mm
  - 2 = 0.37mm
  - 3 = 0.39mm
  - 4 = 0.41mm
  - 5 = 0.43mm
  - 6 = 0.45mm
  - 7 = 0.47mm
  - 8 = 0.49mm
  - 9 = 0.51mm
  - 10 = 0.53mm
  - 11 = 0.55mm
  - 12 = 0.57mm
  - 13 = 0.59mm
  - 14 = 0.61mm
  - 15 = 0.63mm

Code	Description	UOM	Price
M4483	Size 0 Millgrain Wheel, A*F Swiss	EACH	£9.70
M47460	Size 01 Millgrain Wheel	EACH	£3.95
M4484	Size 01 Millgrain Wheel, A*F Swiss	EACH	£9.70
M47461	Size 02 Millgrain Wheel	EACH	£3.95
M4485	Size 02 Millgrain Wheel, A*F Swiss	EACH	£9.70
M47462	Size 03 Millgrain Wheel	EACH	£3.95
M4486	Size 03 Millgrain Wheel, A*F Swiss	EACH	£9.70
M47463	Size 04 Millgrain Wheel	EACH	£3.95
M4487	Size 04 Millgrain Wheel, A*F Swiss	EACH	£9.70
M47464	Size 05 Millgrain Wheel	EACH	£3.95
M4488	Size 05 Millgrain Wheel, A*F Swiss	EACH	£9.70
M47465	Size 06 Millgrain Wheel	EACH	£3.95
M4489	Size 06 Millgrain Wheel, A*F Swiss	EACH	£9.70
M47466	Size 07 Millgrain Wheel	EACH	£3.95
M4490	Size 07 Millgrain Wheel, A*F Swiss	EACH	£9.70
M47467	Size 08 Millgrain Wheel	EACH	£3.95
M4491	Size 08 Millgrain Wheel, A*F Swiss	EACH	£9.70
M47468	Size 09 Millgrain Wheel	EACH	£3.95
M4492	Size 09 Millgrain Wheel, A*F Swiss	EACH	£9.70
M47469	Size 10 Millgrain Wheel	EACH	£3.95
M4493	Size 10 Millgrain Wheel, A*F Swiss	EACH	£9.70
M47470	Size 11 Millgrain Wheel	EACH	£3.95
M4494	Size 11 Millgrain Wheel, A*F Swiss	EACH	£9.70
M47471	Size 12 Millgrain Wheel	EACH	£3.95
M4495	Size 12 Millgrain Wheel, A*F Swiss	EACH	£9.70
M47472	Size 13 Millgrain Wheel	EACH	£3.95
M4496	Size 13 Millgrain Wheel, A*F Swiss	EACH	£9.70
M47473	Size 14 Millgrain Wheel	EACH	£3.95
M4497	Size 14 Millgrain Wheel, A*F Swiss	EACH	£9.70
M47474	Size 15 Millgrain Wheel	EACH	£3.95
M4498	Size 15 Millgrain Wheel, A*F Swiss	EACH	£9.70

**Millgrain Wheels, Extra Large**



- Wheel diameter: Ø6.40mm
- Wheel thickness: 1.10mm
- 30 track beads per mill grain wheel

- Overall length: 67mm
- Made in India

Code	Description	UOM	Price
L36119	Extra Large Millgrain Wheel	EACH	£9.95

**STONE SETTING TOOLS INCLUDING BURNISHERS**



Gemstone setting as a craft has evolved through thousands of years of jewellery making. One of the most rewarding and intricate professions to develop from this diversification is that of the gemstone setter.

Gemstone setting and mounting techniques are used for fixing stones in items of jewellery. Mounting refers to the construction of the metal parts of jewellery, including the supports for the stones. The supports are called setting mounts or collets. Setting is the technique of easing metal over the stones to hold them in place.

A gemstone is kept in place by the adjacent metal, which prevents both sideways and up-and-down movements. The types of gemstone and the desired finish dictate the style of the setting, but, whatever the setting, there must be enough metal and adequate strength to secure the stone.

In the jewellery trade, mounting and setting are separate tasks, and both take time for beginners to master. The small pieces of metal used in these processes are initially difficult to handle, but the task soon becomes easier as the jewellers adjust to small-scale work.

We at CousinsUK have a very comprehensive range of hand tools and equipment perfect for the beginner as well as maintaining high standards for the professional setter.

Here on this page are some of the most popular tools used by our customers and click onto the links below to discover the ancient art of gemstone setting tooling.

**13 Piece Stone Setters Tool Kit**



- Professional stone setters tool kit
- Supplied in a nylon zip lock wallet
- 13 different tools
- Great portable tool kit



**SAME DAY DISPATCH**

Kit includes:

- Bezel setting pusher (B31880)
- Sliding brass vernier gauge (G31917)
- Curved end SS burnisher (B20129)
- Diamond tweezers (T6277)
- Pin vice
- Prong lifter (S39264)
- Wooden ring clamp (R4227)
- Needle files set of 5
- Stone setting pliers (P39493)

Code	Description	UOM	Price
K45712	13 Piece Stone Setters Tool Kit	EACH	£37.95

### Agate Burnishers

Stone Setting - Another hard-to-find tool

- Traditional old school agate burnisher
- These natural stones can be used just like a steel burnisher; for closing bezels and smoothing imperfections in metal
- Agate burnishers remove surface unevenness by pressure and produce a brilliant shine on gold and silver
- Agate is advantageous over steel as it will not damage your stones
- Additional uses include applying gold and silver leaf/foils and burnishing art metal clay before firing
- It is important to avoid knocking the agate burnishers

### Cylinder Tapered Shape with Aluminium Handle



- Diameter of agate Ø6.50mm
- Length of agate 40mm
- Overall length 180mm
- Round to a tapered point

Code	Description	UOM	Price
B36075	Cylinder Tapered Shape with Aluminium Handle	EACH	£4.95

### Knife Shape with Wooden Handle



- Length of agate 35mm
- Overall Length 200mm
- Knife shape

Code	Description	UOM	Price
B45699	Knife Shape with Wooden Handle	EACH	£4.25

### Spear Shape with Wooden Handle



- Length of agate 20mm
- Overall Length 200mm
- Short elongated spear shape

Code	Description	UOM	Price
B31878	Spear Shape with Wooden Handle	EACH	£4.50

### Spear Shape with Wooden Handle, Extra Long



- Length of agate 40mm
- Overall length 220mm
- Long elongated spear shape
- Shallow elongated spear shape

Code	Description	UOM	Price
B36076	Spear Shape with Wooden Handle, Extra Long	EACH	£4.50

### Steel Burnishers

Stone Setting - Steel Burnishers - Pushers & Rollers

- Steel burnishing tools are used for smoothing over parts of soft metal
- Great for channel/bezel setting stones
- With highly polished blades that are firmly set in wood handles

### Bezel Roller Burnisher with Wooden Handle



Bezel Roller is used to rub over the stone collet. It will crease the metal over the stone to hold it in. It is made of soft steel to reduce the risk of damage to the stone.

Code	Description	UOM	Price
B20128	Bezel Roller Burnisher with Wooden Handle	EACH	£1.75

### Curved End Burnisher with Wooden Handle



Curved Burnisher which is oval in shape designed to burnish metal. Rub firmly over the metal and a shiny finish is obtained. Burnishing is an effective method of polishing edges which can occur when you use a mop.

Code	Description	UOM	Price
B20129	Curved End Burnisher with Wooden Handle	EACH	£2.00

### Straight Burnisher with Wooden Handle



Straight Burnisher which is oval in shape designed to burnish metal. Rub firmly over the metal and a shiny finish is obtained. Burnishing is an effective method of polishing edges which can occur when you use a mop.

Code	Description	UOM	Price
B20130	Straight Burnisher with Wooden Handle	EACH	£2.00

### Bezel Setting & Claw Closing

#### Bezel Stone Setting and Claw Closing Tool, Italian



- Punches 2mm to 12mm
- For speedier claw setting
- You are not closing individual claws but all of them in one go
- Very good for batch work

Code	Description	UOM	Price
B8342	Bezel Stone Setting and Claw Closing Tool, Italian	EACH	£87.95

#### Bezel Stone Setting and Claw Closing Tool, Indian



- Punches 0.75mm to 7.75mm
- Set of 18 punches
- For speedier setting
- Round for shaping bezels over round stones
- You are not closing individual claws but all of them in one go
- Very good for batch work
- On wooden stand

Code	Description	UOM	Price
B19165	Bezel Stone Setting and Claw Closing Tool, Indian	EACH	£18.25

PRICE PROMISE **GUARANTEE** ✓

Engravers Block

See Page 665



### Bezel Stone Setting Pusher with Wooden Handle



- For the jeweller, silversmith, arts craft and contemporary jewellers
  - For pushing prongs or crown points around stones.
  - In steel with a grooved tip and wooden handle
- Weight: 30g

Code	Description	UOM	Price
B31880	Bezel Stone Setting Pusher with Wooden Handle	EACH	£1.75

### Stone Setting Claw Pusher Tool



Super prong pusher tool used to push metal over the stone. It is made of soft steel to reduce the risk of damaging the stone.

- Square Flat End

Code	Description	UOM	Price
C20131	Stone Setting Claw Pusher Tool	EACH	£1.75

### Stone Setting Claw & Prong Lifting Tool



Prong lifters are excellent to pull away claws separately without the risk of damaging your gemstones. Simply place grooved slot over a claw according to size, pull towards yourself and see how easy it is to remove the claws and therefore your gemstone.

- Chunky fibre grip
- Tempered carbon steel
- 130mm overall length

Code	Description	UOM	Price
P20859	Stone Setting Claw & Prong Lifting Tool	EACH	£6.95

### Stone Setting Claw & Prong Lifting Tool, Mini



Prong lifters are excellent to pull away claws separately without the risk of damaging your gemstones. Simply place grooved slot over a claw according to size, pull towards yourself and see how easy it is to remove the claws and therefore your gemstone.

- Tempered carbon steel
- 100mm overall length
- Mini version, easy to use and transport

Code	Description	UOM	Price
S39264	Stone Setting Claw & Prong Lifting Tool, Mini	EACH	£1.95

### Bezel Setting & Claw Making



- Stone Setting Claw Making Tool
- 10 piece outfit in wooden box
  - 85 x 85 x 35mm
  - 5 wire holders
  - 4 retaining tubes, inner diameters: Ø8 x Ø8mm, Ø4.80 x Ø8.15, Ø7.20 x Ø10.00 & Ø7.30 x Ø10.20mm
  - 1 main base
  - All accessories are blackened steel.
  - Sizes 0.15 to 2 Carats with 4, 6 & 8 prongs small or large.

How to Use:

- The required number of wires are inserted into the slots and then gripped by the retaining ring. The ends are to be soldered together.
- The retaining ring is then withdrawn.
- The setting is removed and cut to the desired length.
- All accessories are blackened steel.

Code	Description	UOM	Price
C8677	Stone Setting Claw Making Tool	EACH	£13.95

### Bezel Setting Holder



- Setting holder for stones set in tubes/bezels
- Set of 7 spring-tempered 3 jaw collets
- Wooden handle 150mm
- Collet sizes included up to: Ø1.50, 2.00, 2.50, 3.00, 3.50, 4.00 & 5.00mm
- Will hold tube firmly while stone is being set and will not cause tube to collapse
- Handle is partially drilled allowing tube to extend inside handle

Code	Description	UOM	Price
T41185	Tube Setting Holder with 7 Collets	EACH	£6.95

### Stone Setting Depth Collets

- This setting tool saves time and allows you to cut precise bearing seats
- Can be used with either claw or bezel/tube stone settings
- You simply slide the shank of your setting burr through the "Depth Collet" until you reach the desired depth at which you want to cut the seat
- Tighten with the Allen wrench
- Insert your burr (with the depth collet attached) into your micromotor / pendant drill. The depth collet will not allow the burr

- to cut any deeper, thus it keeps the seats even
- The set includes 2 depth collets (1 collet for settings 1/10ct to 1/2ct and 1 depth collet for small prong cluster settings) and an Allen wrench
- Use these depth collets to cut equal bearings in prong settings, gent's rings which require hammer settings and baguette boxes
- Supplied with or without handy wooden storage box

### Stone Setting Depth Collets



Code	Description	UOM	Price
S36117	Stone Setting Depth Collets	PACK*2	£3.95

### Stone Setting Depth Collets, In Wooden Box



Code	Description	UOM	Price
S45697	Stone Setting Depth Collets, In Wooden Box	EACH	£5.95

### Stone Setting Ring Stick



- This is a great tool to ensure gemstones are accurately and evenly presented in a setting in a ring, particularly wedding bands.
- The Stone Setting Faceting Stick has eighteen grooves evenly spaced apart from the top to the bottom of the stick
  - A fast way of positioning stones on rings
  - The taper of the ring stick covers sizes from A to Z
  - Made in UK

How to use:  
Take a look at the diagram of a typical wedding band

and notice how the diamonds have been set spaced apart

To achieve this place, the ring onto the Stone Setting Faceting Stick. Eighteen grooves are lined vertically along the stick. Consider the amount of stones, their size and the preferred amount of space between each stone. Using a marker pen on the ring to create a template for setting, continue the lines from the Faceting Stick onto the ring all the way along the band. To achieve the spacing of stones in the image below typically mark an X in every other segment the entire way around to denote where the stones are to be set. Now the ring is ready to set and the stones will be spaced evenly apart in a symmetrical pattern.

Diamond setting using the Faceting Stick:

- Aluminium body with a wooden handle
- Length 280mm
- Weight 150g

Code	Description	UOM	Price
F4201	Stone Setting Faceting Stick	EACH	£38.95

## TAPS & DIES

### DIES (BY SIZE)

A die fashions a thread on a piece of wire or a bar

Using dies:

- Measure the wire/bar and use a die 0.1mm smaller than the desired thread small. For instance if the wire is a millimetre then use a 0.9mm die.
- The wire / bar should be chamfered to ensure threading can be started with ease, file the end to attain a slight taper.
- Preferably hold the wire/bar vertically in a table vice or alternatively hold with a hand vice, the former will make threading easier and more precise. Great care must be taken to start threading true to the axis of the wire/bar.
- Cut lube or bees wax should be used to rub over the wire/bar before you start, to lubricate.
- The threads must be cleaned as often as is necessary with compressed air or a rubber blower.

PLEASE NOTE: NEVER turn a tap in a die, doing this will damage the threads on both tools, use a measuring gauge (G9737) to determine the size of the tap needed.

### Ø8mm (Tool Steel), Bergeon

Bergeon 2659 - Swiss Made

- Ø8mm (outside Ø)
- Tool Steel
- Metric



Individual tool steel with outside diameter die Ø8mm  
• use with die holder D4676 and D9313

Code	Description	UOM	Price
D4677	Ø.30mm Die, Bergeon 2659	EACH	£45.50
D4703	Ø.35mm Die, Bergeon 2659	EACH	£45.50
D4686	Ø.45mm Die, Bergeon 2659	EACH	£45.50
D4687	Ø.50mm Die, Bergeon 2659	EACH	£45.50
D4688	Ø.55mm Die, Bergeon 2659	EACH	£45.50
D4690	Ø.65mm Die, Bergeon 2659	EACH	£45.50
D4695	Ø1.05mm Die, Bergeon 2659	EACH	£45.50
D4681	Ø1.10mm Die, Bergeon 2659	EACH	£45.50

D4697	Ø1.40mm Die, Bergeon 2659	EACH	£45.50
D4698	Ø1.50mm Die, Bergeon 2659	EACH	£45.50
D4699	Ø1.60mm Die, Bergeon 2659	EACH	£45.50
D4700	Ø1.70mm Die, Bergeon 2659	EACH	£45.50
D4701	Ø1.80mm Die, Bergeon 2659	EACH	£45.50
D4702	Ø2.00mm Die, Bergeon 2659	EACH	£45.50

### Ø16 & 20mm (Tool Steel), Bergeon

Bergeon 30062A - Swiss Made

- Ø16 & 20mm (outside)
- Tool Steel
- Metric



Dies individual tool steel with outside die diameter Ø16mm to Ø20mm

- Use with die holder D6438 for 1mm to 3mm
- Use with die holder D6439 for 3mm to 4mm
- Use with die holder D6440 for 4.5mm to 6mm

Code	Description	UOM	Price
D32835	Ø1.70mm (OD 16mm) Tool Steel	EACH	£43.15
D6448	Ø3.00mm (OD 20mm) Tool Steel	EACH	£28.25
D6451	Ø4.50mm (OD 20mm) Tool Steel	EACH	£28.25
D6452	Ø5.00mm (OD 20mm) Tool Steel	EACH	£28.25
D6453	Ø5.50mm (OD 20mm) Tool Steel	EACH	£28.25
D6454	Ø6.00mm (OD 20mm) Tool Steel	EACH	£28.25

### Ø16 & 20mm (HSS), Bergeon

Bergeon 30062B - Swiss Made

- Ø16 & 20mm (outside)
- High Speed Steel (HSS)
- Metric



Dies individual HSS with outside diameter die Ø16mm to Ø20mm

- Use with die holder D6438 for 1mm to 3mm
- Use with die holder D6439 for 3mm to 4mm
- Use with die holder D6440 for 4.5mm to 6mm

Code	Description	UOM	Price
D32840	Ø1.00mm (OD 16mm) HSS	EACH	£80.85
D32841	Ø1.10mm (OD 16mm) HSS	EACH	£80.85
D32803	Ø1.20mm (OD 16mm) HSS	EACH	£75.70
D32842	Ø1.70mm (OD 16mm) HSS	EACH	£62.75
D32843	Ø1.80mm (OD 16mm) HSS	EACH	£62.75
D32844	Ø2.00mm (OD 16mm) HSS	EACH	£62.75
D6444	Ø2.20mm (OD 16mm) HSS	EACH	£62.75
D32853	Ø2.30mm (OD 16mm) HSS	EACH	£62.75
D32845	Ø2.60mm (OD 16mm) HSS	EACH	£62.75
D32846	Ø3.00mm (OD 20mm) HSS	EACH	£62.75
D32847	Ø3.50mm (OD 20mm) HSS	EACH	£62.75
D32848	Ø4.00mm (OD 20mm) HSS	EACH	£62.75
D32849	Ø4.50mm (OD 20mm) HSS	EACH	£62.75
D32850	Ø5.00mm (OD 20mm) HSS	EACH	£62.75
D32851	Ø5.50mm (OD 20mm) HSS	EACH	£89.95
D32852	Ø6.00mm (OD 20mm) HSS	EACH	£62.75

### TAPS (BY SIZE)



A tap creates an internal thread

Using taps:

Firstly, drill a hole 0.1mm\* smaller than the

desired thread size. For instance if the hole size is 1mm use a 1.10mm tap. Always use one or two tenths of a greater size so the tap incises the hole. This will give an efficient cutting thread to the hole ready to be screwed.

The work piece must be securely supported. When starting the cutting, the tap must be help perpendicularly. Clockwise, turn the tap into the hole, one rotation at a time, to ensure no debris from the process falls into the hole. Use air cleaner or a rubber blower to clean the hole before, during and after tapping. Tapping too fast can shatter the tap. Additionally debris left in the hole causes clogging and the thread may distort, hence breakage. Excessive force will result break the tap. Cut lube or Bees Wax should be used.

\*Sizes vary on the type of metal being tapped, 0.10mm difference will suffice on softer metals such as 22ct or pure gold, however 0.20mm maybe required for harder metals such as silver or 9ct.

\*PLEASE NOTE: NEVER turn a tap in a die, doing this will damage the threads on both tools, use a measuring gauge (G9737) to determine the size of the tap needed.

### Taps (by Size), Metric



Bergeon & Horotec - H.S.S. (High Speed Steel)

- Bergeon 5322 (HSS)
- Bergeon 30063B2 (HSS)
- Horotec MSA.04.524 (HSS)
- Made in Germany (HSS)
- Made in China (HSS)

Tap Holders:

- Use tap holder T9476 for Ø0.3mm to Ø1.0mm
- Use tap holder T9467 for Ø0.8mm to Ø1.5mm
- Use tap holder T6441 for Ø1.0mm to Ø1.8mm
- Use tap holder T6442 for Ø2.0mm to Ø10mm
- Use adjustable tap holder D4749 for Ø1.0mm to Ø6mm
- Use none Swiss tap holder T8678 for Ø1mm to Ø6mm

Code	Description	UOM	Price
T37122	Ø0.30mm Horotec MSA 04.524	EACH	£23.95
T4712A	Ø0.35mm Horotec MSA 04.524	EACH	£23.86
T42092	Ø0.40mm Horotec MSA 04.524	EACH	£23.95
T48749	Ø0.40mm, China	EACH	£7.95
T4714	Ø0.45mm Bergeon 5322	EACH	£15.45
T4715	Ø0.50mm Bergeon 5322	EACH	£15.45
T45757	Ø0.50mm Horotec MSA 04.524	EACH	£17.85
T48750	Ø0.50mm, China	EACH	£7.95
T36959	Ø0.60mm Horotec MSA 04.524	EACH	£18.95
T48751	Ø0.60mm, China	EACH	£7.95
T4718	Ø0.65mm Bergeon 5322	EACH	£12.95
T37077	Ø0.70mm Horotec MSA 04.524	EACH	£12.95
T48752	Ø0.70mm, China	EACH	£7.95
T35883	Ø0.80mm Horotec MSA 04.524	EACH	£12.95
T48753	Ø0.80mm, China	EACH	£7.95
T4722	Ø0.85mm Bergeon 5322	EACH	£12.95
T36787	Ø0.90mm Horotec MSA 04.524	EACH	£12.95
T48754	Ø0.90mm, China	EACH	£4.95
T36121	Ø0.95mm Horotec MSA 04.524	EACH	£12.95
T32257	Ø1.00mm Horotec MSA 04.524	EACH	£12.95
T48755	Ø1.00mm, China	EACH	£4.95
T38225	Ø1.10mm Horotec MSA 04.524	EACH	£12.95
T35423	Ø1.20mm Horotec MSA 04.524	EACH	£12.95
T48756	Ø1.20mm, China	EACH	£4.95
T37076	Ø1.30mm Horotec MSA 04.524	EACH	£12.95
T45758	Ø1.40mm Horotec MSA 04.524	EACH	£13.50
T48757	Ø1.40mm, China	EACH	£4.95

T28052	Ø1.50mm Horotec MSA 04.524	EACH	£13.50
T48758	Ø1.50mm, China	EACH	£4.95
T35422	Ø1.60mm Horotec MSA 04.524	EACH	£13.50
T48759	Ø1.60mm, China	EACH	£4.95
T37753	Ø1.70mm Horotec MSA 04.524	EACH	£13.50
T48760	Ø1.70mm, China	EACH	£4.95
T38257	Ø1.80mm Horotec MSA 04.524	EACH	£13.50
T48761	Ø1.80mm, China	EACH	£4.95
T45759	Ø2.00mm Horotec MSA 04.524	EACH	£14.95
T48762	Ø2.00mm, China	EACH	£4.95
T6455	Ø2.20mm Bergeon 30063B2	EACH	£35.80
T45760	Ø2.20mm Horotec MSA 04.524	EACH	£14.95
T45761	Ø2.30mm Horotec MSA 04.524	EACH	£14.95
T45762	Ø2.40mm Horotec MSA 04.524	EACH	£14.95
T45763	Ø2.50mm Horotec MSA 04.524	EACH	£14.95
T48763	Ø2.50mm, China	EACH	£4.95
T45764	Ø2.60mm Horotec MSA 04.524	EACH	£14.95
T48764	Ø2.60mm, China	EACH	£4.95
T45765	Ø3.00mm Horotec MSA 04.524	EACH	£17.15
T48765	Ø3.00mm, China	EACH	£4.95
T6460	Ø3.50mm Bergeon 30063B2	EACH	£27.40
T45766	Ø3.50mm Horotec MSA 04.524	EACH	£17.15
T48766	Ø3.50mm, China	EACH	£4.95
T6461	Ø4.00mm Bergeon 30063B2	EACH	£24.95
T45767	Ø4.00mm Horotec MSA 04.524	EACH	£18.95
T48767	Ø4.00mm, China	EACH	£4.95
T6462	Ø4.50mm Bergeon 30063B2	EACH	£29.50
T45768	Ø4.50mm Horotec MSA 04.524	EACH	£18.95
T48768	Ø4.50mm, China	EACH	£4.95
T6463	Ø5.00mm Bergeon 30063B2	EACH	£27.40
T45769	Ø5.00mm Horotec MSA 04.524	EACH	£19.95
T48769	Ø5.00mm, China	EACH	£4.95
T6464	Ø5.50mm Bergeon 30063B2	EACH	£53.70
T6465	Ø6.00mm Bergeon 30063B2	EACH	£27.40
T45770	Ø6.00mm Horotec MSA 04.524	EACH	£19.95
T48770	Ø6.00mm, China	EACH	£4.95
T48748	Ø6.50mm China	EACH	£5.95
T48747	Ø6.50mm Germany	EACH	£39.95
T48771	Ø7.00mm, China	EACH	£4.95

**TAP & DIE HOLDERS**

**Die Holder - Ø8mm (outside) Bergeon 4235**

Watchmakers & Jewellers Thread Cutting Die Holder  
 • For Outside Diameter Ø8mm Dies  
 • Bergeon 4235  
 • Swiss made



Code	Description	UOM	Price
D4676	Bergeon 4235 Die Holder	EACH	£61.50

**Die Holder - Ø8mm (outside) Bergeon 30010BR**



Engineers, Watchmakers & Jewellers Thread Cutting Die Holder  
 • For Outside Diameter Ø8mm Dies  
 • Double Handled  
 • Bergeon 30010BR

• Swiss made

Code	Description	UOM	Price
D9313	Bergeon 30010BR Die Holder	EACH	£35.15

**Die Holder - Bergeon 30064**



Engineers, Watchmakers & Jewellers Thread Cutting Die Holder

- Double handled with tightening screws
- Swiss made

Bergeon 30064-1:  
 • For Outside Diameter Ø16mm Dies  
 • Tap Sizes: Ø1.00mm to Ø2.60mm

Bergeon 30064-2:  
 • For Outside Diameter Ø20mm Dies  
 • Tap Sizes: Ø3.00mm to Ø4.00mm

Bergeon 30064-3:  
 • For Outside Diameter Ø20mm Dies  
 • Tap Sizes: Ø4.50mm to Ø6.00mm

Code	Description	UOM	Price
D6438	Ø16mm (Ø1.00mm to Ø2.60mm) Bergeon 30064.1	EACH	£19.95
D6439	Ø20mm (Ø3.00mm to Ø4.00mm) Bergeon 30064.2	EACH	£19.95
D6440	Ø20mm (Ø4.50mm to Ø6.00mm) Bergeon 30064.3	EACH	£19.95

**Tap Holder - Bergeon 30065**



Engineers, Watchmakers & Jewellers Tap Holder

- Double Handled, Adjustable
- Bergeon 30065
- Swiss made

Bergeon 30065-1:  
 • Tap Sizes: Ø1.00mm to Ø2.60mm

Bergeon 30064-2:  
 • Tap Sizes: Ø3.00mm to Ø4.00mm

Code	Description	UOM	Price
T6441	Taps Ø1.00mm to Ø3.00mm, Bergeon 30065-1	EACH	£36.95
T6442	Taps Ø3.00mm to Ø10.00mm, Bergeon 30065-2	EACH	£36.95

**Tap Holder - Bergeon 30419**



Engineers, Watchmakers & Jewellers Tap Holder

- Ø1.00mm to Ø6.00mm capacity
- Double Handled, Adjustable
- Bergeon 30419
- Swiss made

Code	Description	UOM	Price
D4749	Tap Holder (Ø1 - 6mm) Bergeon 30419	EACH	£63.95

**Tap Holder - Non Swiss**



Engineers, Watchmakers & Jewellers Tap Holder

- Double Handled, Adjustable
- Tap Sizes: Ø2mm to Ø10mm

Code	Description	UOM	Price
T8678	Taps Ø2mm to Ø10mm, Indian	EACH	£3.15

**TAP & DIE SETS**

Select a hole with a thread diameter less than the wire's diameter (to cut into the wire and from threads).

Always use cutting lube or Bees Wax, applying it where necessary while cutting a thread.

1. Clamp the bar/wire vertically in a vice.
2. Once the die has been secured in the holder, with the side screw, set the die down firmly onto the wire; turn the die clockwise. The die cuts into the wire as it threads the wire.
3. Continue to wind the die until the desired depth of thread is achieved.
4. Reverse the action and remove the die.

Taps: use to create interior threads for a screw or bolt.

1. Drill a hole that corresponds to the tap size to be used.
2. Insert the tap, turn a quarter and then retract.
3. Continue by turning a quarter at a time until the hole is completely tapped.
4. Keep taps free of shavings while tapping.

**Ø0.40mm to Ø1.40mm, German**



Ø0.40mm to Ø1.40mm - Made in Germany

Contains:

- 36 Taps: 12 sizes of tap (3 of each provided): Ø0.40, 0.45, 0.50, 0.60, 0.65, 0.80, 0.90, 1.00, 1.10, 1.20, 1.30 & 1.40mm
- 12 Dies: Ø0.40, 0.45, 0.50, 0.60, 0.65, 0.80, 0.90, 1.00, 1.10, 1.20, 1.30 & 1.40mm
- Tool steel, suitable for soft, non ferrous metals
- Wooden Presentation Case
- Made in Germany

Code	Description	UOM	Price
T35668	Ø0.4mm to Ø1.2mm Tap & Die Set	PACK*49	£379.95

**Ø0.60mm to Ø1.00mm, Indian**



Ø0.60mm to Ø1.00mm - Economy

- 5 Taps : 0.6, 0.7, 0.8, 0.9 & 1mm
- 5 Dies : 0.6, 0.7, 0.8, 0.9 & 1mm

Code	Description	UOM	Price
T34942	Tap and Die Set, 0.6mm to 1.00mm	PACK*6	£5.95

**WORLDWIDE DELIVERY**

**Ø0.70mm to Ø2.00mm, Indian**



Ø0.70mm to Ø2.00mm - Economy

Die plate information:

- Use the top row on the plate to cut the thread
- The bottom row is to test the purity of the thread; if the thread has been distorted during tapping then the thread will not screw through fluently.

Screw plate is made from tempered steel comprising of circular or double notched threaded holes graduating in size, these are used to make exterior threads.

Contains:

- Screw plate die
- 13 taps in a wooden box
- Sizes: Ø0.70mm to 2mm
- Weight 200g
- Made in India

Code	Description	UOM	Price
T20863	Tap and Die Set 0.70mm to 2.00mm	PACK*14	£14.95

**Ø1.00mm to Ø2.50mm, Rolson**



Ø1.00mm to Ø2.50mm - Rolson

- 18 Taps: 1.00 to 2.5mm (taper & plug)
- 9 Split Dies: Ø1.00, 1.10, 1.20, 1.40, 1.60, 1.80, 2.00, 2.20 & 2.50mm
- Holder for dies and taps
- HSS Steel

Code	Description	UOM	Price
T35450	Tap & Die Set Ø1.00 to Ø2.50mm	PACK*28	£45.95

**Ø1.00mm to Ø3.00mm, Bergeon Swiss**



Ø1.00mm to Ø3.00mm - Bergeon Swiss

- Bergeon 30322-AR
- 8 Dies, Ø1.00mm to Ø3.00mm

- 8 sets of 3 taps, Ø1.00mm to Ø3.00mm
- 1 Die holder, Bergeon 30322-PF1
- 1 Die holder, Bergeon 30064-1
- 1 Hand wrench, Bergeon 30419
- In wooden Box

Code	Description	UOM	Price
T37726	Tap & Die set, Bergeon 30322-AR	EACH	£1,650.00

**Ø1.00mm to Ø3.00mm, German**



Ø1.00mm to Ø3.00mm - Made in Germany

- 8 sizes of tap (3 of each provided): Ø1.00, 1.20, 1.40, 1.70, 2.00, 2.30, 2.60 & 3.00mm
- 8 Dies: Ø1.00, 1.20, 1.40, 1.70, 2.00, 2.30, 2.60 & 3.00mm
- Die Stock
- Adjustable die stock
- HSS (high speed steel), suitable for hard, ferrous metals
- Wooden Presentation Case
- Made in Germany

Code	Description	UOM	Price
T35667	Ø1.00mm to Ø3mm Tap & Die Set	PACK*33	£249.95

**Ø1.00mm to Ø3.00mm, Bergeon Swiss**



Ø1.00mm to Ø6.00mm - Bergeon Swiss

- Bergeon 30418-AR
- 14 Dies, Ø1.00mm to Ø6.00mm
- 14 sets of 3 taps, Ø1.00mm to Ø6.00mm
- 1 Die holder, Bergeon 30064-1
- 1 Die holder, Bergeon 30064-2
- 1 Die holder, Bergeon 30064-3
- 1 Hand wrench, Bergeon 30065-1
- 1 Hand wrench, Bergeon 30065-2
- In wooden box

Code	Description	UOM	Price
T37727	Tap & Die Set	EACH	£1,895.00

**PRICE PROMISE GUARANTEE**

**Pin Vices with Handles**

**See Page 914**

**Ø1.40mm to Ø1.80mm, Indian**



Ø1.40mm to Ø1.80mm - Economy

- 5 Taps: 1.40, 1.50, 1.60, 1.70, 1.80mm
- 5 Dies: 1.40, 1.50, 1.60, 1.70, 1.80mm

Code	Description	UOM	Price
T35081	Tap and Die Set, 1mm to 5mm	PACK*6	£5.95

**Tap & Die Set - Extra large**



Blue Spot Tap and Die Set

- Extra large Tap and Die Set
- Excellent value
- Made to precision
- 40 piece

Kit contains:

- 17 taps & 17 dies: M3x0.5 - M3x0.6 - M4x0.7 - M4x0.75 - M5x0.8 - M5x0.9 - M6x0.75 - M6x1.0 - M7x0.75 - M7x1.0 - M8x1.0 - M8x1.25 - M10x1.25 - M10x1.5 - M12x1.5 - 12x1.75 - 1/8 NPT
- 1 long handled adjustable tap wrench
- 1 "T" handle tap wrench
- 1 screwdriver
- 1 screw pitch gauge
- Complete set comes in a plastic compartment storage box

Code	Description	UOM	Price
T35313	Tap & Die Set - Extra large	PACK*40	£14.85



**Drill Bits - HSS**

**See Page 836**

**Bench Drills**

**See Page 659**



# TWEEZERS

## TWEEZER CASES

### Tweezer Cases



Ensure protection of your tweezers with these specialised tweezer storage & transportation cases.

- 3, 4 or 7 tweezers storage
- Dumont Swiss or unbranded
- Varnished wooden boxes
- Natural wood or white finish
- Dumont cases have Dumont logo and special foam inserts
- See website "more info" for further specification

Code	Description	UOM	Price
B43269	3 Tweezers Case, Dumont Swiss	EACH	£27.95
C47151	4 Tweezers Case	EACH	£5.95
C47150	7 Tweezers Case	EACH	£5.95
B43270	7 Tweezers Case, Dumont Swiss	EACH	£39.95

## COUSINS TITANIUM TWEEZERS

### Titanium Tweezers, Cousins Swiss Style



- Titanium tweezers
- No.3 & No.5
- Lightweight & strong
- Non magnetic
- High resistance to corrosion and wear (abrasion)
- Overall length 115mm
- Superb Swiss quality
- Cousins Swiss Style

Code	Description	UOM	Price
T48810	No.3 (Fine Tip) Titanium Tweezers	EACH	£7.50
T48811	No.5 (Super Fine Tip) Titanium Tweezers	EACH	£7.50

## DUMONT TWEEZERS



Dumont Tweezers handmade tools since 1881 Discover a range of Swiss hand crafted tweezers in different fields. Guaranteed Swiss manufactured.

With various industries demanding the highest quality tools Dumont have been the forefront

market leaders. Some applications Dumont tweezers are used include:

- Watchmakers and repair services
- Jewellery making / repairing
- Medical
- Cosmetic
- Electronics and micro electronics
- High precision engineering
- Biology

Dumont tweezers are available in various versions:

- **Dumont Dumostar** – 100% Anti-magnetic, meaning magnetic items (e.g. a watch rotor) will not stick to the tweezers. Dumostar is more elastic and more resistant to corrosion than the best stainless steels. It is also perfectly compatible with human tissue and is resistant to mineral and organic acids as well as salt. Heat resistant to sterilization temperatures of up to 550°C and never loses flexibility.
- **Dumont Dumoxel** – 95% Anti-magnetic stainless steel, meaning magnetic items (e.g. a watch rotor) will stick to the tweezers but the tweezers will not become magnetised. Dumoxel is the most popular alloy among customers and was patented by Dumont to offer the best in resistance to corrosion thanks to its high concentration of molybdenum and chromium. Dumoxel also guarantees an excellent resistance to sulphuric environments, hydrochloric acid, as well as all other mineral and organic acids. Heat resistant to sterilization temperatures of up to 400°C and is suitable for autoclave sterilization at 270°C.
- **Dumont ESD** - Electrostatic discharge safe, black conductive coated tweezers. The coating eliminates static electricity making them excellent for when working with electrical components.
- **Dumont Hi-Tec** – Stainless Steel, a patented alloy providing the most favourable aspects of stainless steel as well as sufficient hardness and durability.
- **Dumont Original** – Carbon Steel, will endure hard use of the tips, can become magnetised.
- **Dumont Super Hi-Tec** – Titanium, totally resistant to corrosion from nitric acid, chloride, salt water and the like. More flexible than stainless steel and 40% lighter. Titanium 100% anti-magnetic and resistant up to temperatures of around 430°C.

### Dumont No.1 (Fine & Strong)



- No.1 tweezers
- Fine and strong tips
- 120mm overall length
- See "More Info" or "Category Info" for definitions of type

Code	Description	UOM	Price
T1779	Dumostar 100% Anti-magnetic	EACH	£39.95
T1756	Dumoxel 95% Anti-magnetic	EACH	£22.95
T1736	Hi-Tec, Stainless Steel	EACH	£19.95
T1725	Original, Carbon Steel	EACH	£29.95



**BROWSE & BUY**

### Dumont No.2 (Medium Tips)



- No.2 tweezers
- Medium tips
- 120mm overall length
- See "More Info" or "Category Info" for definitions of type

Code	Description	UOM	Price
T1780	Dumostar 100% Anti-magnetic	EACH	£38.50
T1757	Dumoxel 95% Anti-magnetic	EACH	£21.95
T38851	ESD, Stainless Steel	EACH	£18.95
T1737	Hi-Tec, Stainless Steel	EACH	£21.85
T1726	Original, Carbon Steel	EACH	£27.95

### Dumont No.2A (Broad Tips)



- No.2A tweezers
- Broad tips
- 120mm overall length
- See "More Info" or "Category Info" for definitions of type

Code	Description	UOM	Price
T1737A	Hi-Tec, Stainless Steel	EACH	£26.25

### Dumont No.3 (Fine Tips)



- No.3 tweezers
- Fine tips
- 120mm overall length
- See "More Info" or "Category Info" for definitions of type

Code	Description	UOM	Price
T1781	Dumostar 100% Anti-magnetic	EACH	£39.95
T1758	Dumoxel 95% Anti-magnetic	EACH	£23.65
T38850	ESD, Stainless Steel	EACH	£22.95
T1738	Hi-Tec, Stainless Steel	EACH	£23.25
T1727	Original, Carbon Steel	EACH	£27.85
T5487	Super Hi-Tec, Titanium	EACH	£37.50

### Dumont No.3C (Fine Tips)



- No.3c tweezers
- Fine tips
- 110mm overall length



**Online Order Tracking**

• See "More Info" or "Category Info" for definitions of type

Code	Description	UOM	Price
T1782	Dumostar 100% Anti-magnetic	EACH	£35.95
T1759	Dumoxel 95% Anti-magnetic	EACH	£23.55
T1739	Hi-Tec, Stainless Steel	EACH	£22.95
T1728	Original, Carbon Steel	EACH	£23.50

### Dumont No.4 (Extra Fine Tips)



- No.4 tweezers
- Extra fine tips
- 110mm overall length
- See "More Info" or "Category Info" for definitions of type

Code	Description	UOM	Price
T1783	Dumostar 100% Anti-magnetic	EACH	£45.50
T1760	Dumoxel 95% Anti-magnetic	EACH	£20.25
T1740	Hi-Tec, Stainless Steel	EACH	£17.95
T1729	Original, Carbon Steel	EACH	£26.95

### Dumont No.5 (Super Fine Tips)



- No.5 tweezers
- Super fine tips
- 110mm overall length
- See "More Info" or "Category Info" for definitions of type

Code	Description	UOM	Price
T1784	Dumostar 100% Anti-magnetic	EACH	£38.95
T1761	Dumoxel 95% Anti-magnetic	EACH	£22.95
T38849	ESD, Stainless Steel	EACH	£17.95
T1741	Hi-Tec, Stainless Steel	EACH	£21.95
T1730	Original, Carbon Steel	EACH	£29.95
T5488	Super Hi-Tec, Titanium	EACH	£34.95

### Dumont No.5A (Super Fine Oblique Tips)



- No.5a tweezers
- Super fine oblique tips
- 115mm overall length
- See "More Info" or "Category Info" for definitions of type

Code	Description	UOM	Price
T1742	Hi-Tec, Stainless Steel	EACH	£22.95
T1731	Original, Carbon Steel	EACH	£20.95

### Dumont No.6 (Angled Extra Fine Tips)



- No.6 tweezers
- Angle "hooked" extra fine tips
- See "More Info" or "Category Info" for definitions of type

Code	Description	UOM	Price
T49236	Dumoxel 95% Anti-Magnetic	EACH	£37.50

### Dumont No.7 (Fine Curved Tips)



- No.7 tweezers
- Fine curved tips
- 120mm overall length
- See "More Info" or "Category Info" for definitions of type

Code	Description	UOM	Price
T1785	Dumostar 100% Anti-magnetic	EACH	£45.25
T47193	Dumoxel 95% Anti Magnetic, No.7	EACH	£31.60
T1744	Hi-Tec, Stainless Steel	EACH	£25.95
T1732	Original, Carbon Steel	EACH	£30.75
T5489	Super Hi-Tec, Titanium	EACH	£46.50

### Dumont No.AA (Fine Strong Tips)



- No.AA tweezers
- Fine strong tips
- 115mm overall length
- See "More Info" or "Category Info" for definitions of type

Code	Description	UOM	Price
T1762	Dumoxel 95% Anti-magnetic	EACH	£22.75
T38852	ESD, Stainless Steel	EACH	£16.95
T1745	Hi-Tec, Stainless Steel	EACH	£17.55
T5490	Super Hi-Tec, Titanium	EACH	£34.75

### Dumont No.F (Broad Flat Tips)



- No.F tweezers
- Broad flat tips
- 120mm overall length
- See "More Info" or "Category Info" for definitions of type

Code	Description	UOM	Price
T42151	Dumoxel 95% Anti-magnetic	EACH	£26.95
T42150	Original, Carbon Steel	EACH	£24.95

### Dumont No.GG (Fine Long Heavy Duty Tips)



- No.GG tweezers
- Fine long heavy duty tips
- 130mm overall length
- See "More Info" or "Category Info" for definitions of type

Code	Description	UOM	Price
T1750	Hi-Tec, Stainless Steel	EACH	£26.75

### Dumont No.NN (Fine Long Tips)



- No.NN tweezers
- Fine long tips
- 115mm overall length
- See "More Info" or "Category Info" for definitions of type

Code	Description	UOM	Price
T1752	Hi-Tec, Stainless Steel	EACH	£17.55

### Dumont No.OO (Medium Tips)



- No.OO tweezers
- Medium tips
- 120mm overall length
- See "More Info" or "Category Info" for definitions of type

Code	Description	UOM	Price
T1753	Hi-Tec, Stainless Steel	EACH	£10.95

### Dumont No.QQ (Fine Tips)



- No.QQ tweezers
- Fine tips
- 115mm overall length
- See "More Info" or "Category Info" for definitions of type

Code	Description	UOM	Price
T1754	Hi-Tec, Stainless Steel	EACH	£17.55

### Dumont No.S (Fine Tips)



- No.S tweezers
- Fine tips
- 120mm overall length
- See "More Info" or "Category Info" for definitions of type

Code	Description	UOM	Price
T1734	Original, Carbon Steel	EACH	£23.10

**PRICE PROMISE  
GUARANTEE**

**Dumont No.SS Tweezers  
(Very Fine Tips)**



- No.SS tweezers
- Very fine tips
- 140mm overall length
- See "More Info" or "Category Info" for definitions of type

Code	Description	UOM	Price
T1770	Dumoxel 95% Anti-magnetic	EACH	£24.95

Magnetic items such as quartz watch rotors will NOT stick to these Tweezers.

- Anti magnetic
- Especially designed for the rotors in quartz watches
- High quality
- Unbelievable value
- Balanced weight and precision tips
- Stainless steel
- Overall length 120mm

T39593:

- 316-L High Grade Steel
- Polished inside and out
- Very Smooth Swiss style finish

Code	Description	UOM	Price
T39590	100% Anti-Magnetic No.AA	EACH	£2.10
T39593	100% Anti-Magnetic No.11	EACH	£3.95

**Vetus Tweezers, Swiss Standard**



Vetus Tweezers are your best choice for high quality Swiss type precision stainless tweezers.

"Swiss quality without the Swiss Price"

- Vetus Tweezers are one of the largest manufacturers and suppliers of precision high quality tweezers and forceps
- Vetus manufacturers tweezers for all types of electronics assembly, machine assembly, service, manual plucking, handling biomolecules, micro assembly and manufacturing, industrial supply, clock & watch repairing and assembly
- Vetus use the finest materials and most stringent manufacturing standards but still offer the best tweezers value
- Stainless steel construction keeps tools corrosion free and easy to clean. All of our tweezers are anti-magnetic, acid resistant and temperature resistant
- Vetus supply the most advanced styles and designs for the highest quality and performance, all at the most competitive prices

Specifications:

- Anti Magnetic
- Anti Acid
- Non Corrosive
- Stainless Steel
- Overall Length 110mm

Code	Description	UOM	Price
T19567	No.27 (Medium Tip) Tweezers, Vetus ST-12	EACH	£3.75
T19568	No.2A (Broad Tip) Tweezers, Vetus ST-13	EACH	£3.95
T19569	No.3 (Fine Tip) Tweezers, Vetus ST-10	EACH	£3.95
T19570	No.5 (Super Fine Tip) Tweezers, Vetus ST-14	EACH	£3.95
T19571	No.7 (Fine Curved Tip) Tweezers, Vetus ST-15	EACH	£2.95
T19572	No.SS (Very Fine Tip) Tweezers, Vetus ST-11	EACH	£2.95

**WATCHMAKERS  
VALUE TWEEZERS**

*Stella European Quality Anti-Magnetic Tweezers*

- *Balanced weight and precision tips. Unmatched quality for the price*

*100% Anti-Magnetic Tweezers*

- *Magnetic items such as quartz watch rotors will NOT stick to these Tweezers*

*Vetus Tweezers, Swiss Standard*

- *Your best choice for high quality Swiss type precision stainless tweezers.*

*"Swiss quality without the Swiss Price"*

**Stella European Quality Anti-Magnetic Tweezers**



Tweezers - Anti-Magnetic

Balanced weight and precision tips. Unmatched quality for the price.

- Anti magnetic
- High quality
- Unbelievable value
- Stainless steel
- Overall length 120mm

Code	Description	UOM	Price
T39568	No.AA Anti-magnetic SS tweezers	EACH	£1.75
T39569	No.1 Anti-magnetic SS tweezers	EACH	£1.75
T39573	No.2 Anti-magnetic SS tweezers	EACH	£1.75
T39570	No.3 Anti-magnetic SS tweezers	EACH	£1.75
T39574	No.3C Anti-magnetic SS tweezers	EACH	£1.75
T39571	No.4 Anti-magnetic SS tweezers	EACH	£1.75
T39572	No.5 Anti-magnetic SS tweezers	EACH	£1.75

**100% Anti-Magnetic Tweezers**



Tweezers - Anti-Magnetic - Special for Rotors in Quartz Watches

**WATCHMAKERS  
TWEezer SETS**

*Wooden Cases (WC) or Plastic Pouches*

*A great selection and variety of tweezers sets catering for watchmakers (as well as other professionals) that require or want a complete range of tweezers, presented & stored neatly at their fingertips.*

- Epoxy coated
- Stainless Steel
- Titanium
- Watchmakers

**Epoxy Coated**



Tweezers - Watchmakers - Epoxy Coated - Set of 6

- They come in a convenient storage pouch for easy access and organization
- Black epoxy coated stainless steel

Set includes:

- 1 x No.00
- 1 x No.2A
- 1 x No.3C
- 1 x No.5
- 1 x No.7
- 1 x No.SS

Code	Description	UOM	Price
T37833	Tweezer Set, Epoxy coated	EACH	£5.95

**Stainless Steel, Set of 4 (WC)**



- Set of 4 tweezers
- Stainless steel
- Excellent value
- Tweezers are 120mm long
- Maximum length tweezers the box can hold 130mm
- Supplied in wooden case (WC)

Set contains:

- No.1 (fine strong tips)
- No.3 (fine tips)
- No.5 (super fine tips)
- No.7 (fine curved tips)

Code	Description	UOM	Price
T39575	Stainless Steel Tweezer Box Set	PACK*4	£7.50

**Tool Box Tidy**

**Ref: B9477**  
**See Page: 780**

**Stainless Steel, Set of 5**



- Set of 5 tweezers
- Stainless steel
- Excellent value
- Supplied in plastic pouch

Set contains:

- No.3 (fine tips)
- No.5 (super fine tips)
- No.AA (long fine tips)
- No.MM (fine, long heavy duty tips)
- No.NN (long fine tips)

Code	Description	UOM	Price
T39578	Stainless Steel Tweezer Set	PACK*5	£4.95

**Stainless Steel, Set of 5 - Satin Finish**



- Set of 5 tweezers
- Satin finish stainless steel
- Excellent value
- Supplied in plastic pouch

Set contains:

- No.3 (fine tips)
- No.5 (super fine tips)
- No.AA (long fine tips)
- No.MM (fine, long heavy duty tips)
- No.OO (long fine tips)

Code	Description	UOM	Price
T41495	Satin Steel Tweezer Set	PACK*5	£6.95

**Stainless Steel, Set of 7 (WC)**



- Set of 7 tweezers
- Stainless steel
- Tweezers are 120mm long
- Maximum length tweezers the box can hold 130mm
- Excellent value
- Supplied in wooden case (WC)

Set contains:

- No.2A (broad tips)
- No.3C (fine tips)
- No.5 (super fine tips)
- No.5A (super fine tips)
- No.6 (angled, super fine tips)
- No.7 (fine curved tips)
- No.OO (medium tips)

Code	Description	UOM	Price
T39576	Stainless Steel Tweezer Box Set	PACK*7	£11.95

**Stainless Steel, Set of 8**



- Set of 8 tweezers
- Stainless steel
- Superior quality & excellent value
- Supplied in plastic pouch

Set contains:

- No.1 (fine & strong tips)
- No.3 (fine tips)
- No.3C (fine tips)
- No.5 (super fine tips)
- No.7 (fine curved tips)
- No.AA (long fine tips)
- No.MM (fine, long heavy duty tips)
- No.SS (fine tips)

Code	Description	UOM	Price
T39577	Stainless Steel Tweezer Set, Superior Quality	PACK*8	£8.95

**Titanium, Set of 3**



- Set of 3 tweezers
- Titanium
- Lightweight & strong
- Non magnetic
- High resistance to corrosion and wear (abrasion)
- Supplied in plastic pouch

Set contains:

- No.1 (fine tips)
- No.5 (super fine tips)
- No.AA (long fine tips)

Code	Description	UOM	Price
T39581	Titanium Tweezer Set	PACK*3	£11.95

**WATCHMAKERS  
SPECIALIST TWEEZERS**

***Breguet Hairspring  
Tweezers, Dumont***

Highly specialised watchmaking tweezers for bending and curving breguet hairsprings.

- Dumont Swiss Made
- Carbon
- Polished
- Length 110mm

T47194:

- Tip Width 1.50mm
- Curved Tip Radius 0.55mm

T47195:

- Holding Gap 0.30mm
- Tip Width 0.60mm
- Curved Tip Radius 0.32mm

T47196:

- Holding Gap 0.80mm
- Tip Width 2.00mm
- Curved Tip Radius 1.00mm

**Size 00, to Bend Breguet Hairprings**



- Dumont Swiss Made
- Carbon
- Polished
- Length 110mm
- Tip Width 1.50mm
- Curved Tip Radius 0.55mm

Code	Description	UOM	Price
T47194	Size 00, to Bend Breguet Hairprings	EACH	£275.00

**Bergeon Rodico**

Ref: R1460  
See Page: 1194

**TODAY** SAME DAY DISPATCH

**Size 00, to Curve Breguet Hairprings**



- Dumont Swiss Made
- Carbon
- Polished
- Length 110mm
- Holding Gap 0.30mm
- Tip Width 0.60mm
- Curved Tip Radius 0.32mm

Code	Description	UOM	Price
T47195	Size 00, to Curve Breguet Hairprings	EACH	£129.95

**Size 4, to Curve Breguet Hairprings**



- Dumont Swiss Made
- Carbon
- Polished
- Length 110mm
- Holding Gap 0.80mm
- Tip Width 2.00mm
- Curved Tip Radius 1.00mm

Code	Description	UOM	Price
T47196	Size 4, to Curve Breguet Hairprings	EACH	£129.95

**Cutting Tweezers**

Tweezers - Cutting

- Used to cut fine coils and springs
- Great for threads and wires
- Dumont is ESD (electrostatic discharge safe)

**Cutting "D", Bergeon Swiss**



- Bergeon 1056D
- Length 95mm
- Medium duty
- Used to cut fine coils and springs
- Great for threads and wires

Code	Description	UOM	Price
T1791	Cutting "D", Bergeon Swiss	EACH	£27.75

**Cutting "D", Indian**

**VALUE**



- Light duty
- Indian

- Used to cut fine coils and springs
- Great for threads and wires

Code	Description	UOM	Price
T34700	Cutting "D", Indian	EACH	£2.25

**Flush Cut (ESD Plastic Coated),**

**Dumont**



Dumont ESD - Electrostatic discharge safe, black conductive coated tweezers. The coating eliminates static electricity making them excellent for when working with electrical components.

- Length 110mm
- Light duty
- Flush cut
- Plastic coated
- Used to cut fine coils and springs
- Great for threads and wires

Code	Description	UOM	Price
T1789	Flush Cut (ESD Plastic Coated), Dumont	EACH	£42.95

**Flush Cut (15A), Indian**

**VALUE**



Code	Description	UOM	Price
T39589	Flush Cut (15A), Indian	EACH	£4.65

**Hand Removing Tweezers**

**VALUE**



Tweezers - Hand Removing

- "K" Tweezer
- For removing watch hands
- Simple execution
- Made in India

Code	Description	UOM	Price
T37638	K Tweezer, Indian	EACH	£1.50

**Hand Removing Tweezers, Horotec Swiss**



Tweezers - Hand Removing - Horotec Swiss

- Tweezers for removing & handling watch hands
- 7 sizes to hold and remove hands
- With or without locking
- Carbon steel
- No.14
- Length 115mm
- Swiss made
- Horotec Swiss

Code	Description	UOM	Price
T44248	Hand Removing Tweezers, Swiss	EACH	£69.95
T44249	Hand Removing Tweezers, Swiss with Locking	EACH	£99.95

**Hand Fitting Tweezers, Bergeon Swiss**



Tweezers - Hand Fitting - Bergeon Swiss

- Tweezers for handling watch hands
- Mirror polished tips prevents scratching & marking
- Stainless steel
- Length 115mm
- Bergeon 7029-F

Code	Description	UOM	Price
T40486	Hand Tweezers, Bergeon Swiss	EACH	£37.50

**Hand Fitting Tweezers, Horotec Swiss**

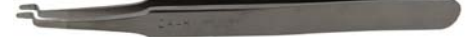

Tweezers - Hand Fitting - Horotec Swiss

- Tweezers for handling watch hands
- Mirror polished tips prevents scratching & marking
- 100% anti-magnetic, magnetic items will not stick to tweezers
- Stepped tips for extra ease of handling
- Stainless steel
- Length 120mm
- Swiss made
- Horotec 12.302-2A-H

Code	Description	UOM	Price
T44250	Hand Fitting Tweezers, Horotec Swiss	EACH	£59.95

**Incabloc Tweezers, Dumont**



"Original Incabloc" highly specialised watchmaking tweezers for holding incabloc shock absorbers.

- Dumont Swiss Made
- Stainless Steel
- Polished
- Length 135mm

Code	Description	UOM	Price
T47197	Incabloc Tweezer	EACH	£74.95

**Mainspring Oiling Tweezers, Horotec Swiss**



Vulcanized Fibre - Horotec - Swiss Made - Anti magnetic

- Felt covered tips
- Vulcanised fibre
- Anti magnetic
- Nickel body
- 130mm
- Swiss made
- Horotec 12.729

Vulcanized fibre is a laminated plastic composed of only cellulose. The material is a tough, resilient, hornlike

material that is lighter than aluminium, tougher than leather, and stiffer than most thermoplastics.

Code	Description	UOM	Price
T44155	Mainspring Oiling Tweezers, Horotec	EACH	£26.75

Screw Holding Tweezers

VALUE



Tweezers - Screw Holding

- Handle small screws with ease with these specially designed tweezers
- Perfect for any watch repairer
- Overall length 120mm
- Made in India

Code	Description	UOM	Price
T36500	Screw Holding Tweezers	EACH	£2.25

BRASS TWEEZERS

Brass is 100% anti-magnetic and is widely used for handling delicate components, especially in watch-making. This alloy cannot be sterilized.

Brass Tweezers

VALUE



Brass is 100% anti-magnetic and is widely used for handling delicate components, especially in watch-making. This alloy cannot be sterilized.

- Anti Magnetic
- Brass
- Do not react to acid
- Soft metal, good for handling delicate objects
- Indian

AA = Fine strong tip

3 = Fine tip

Code	Description	UOM	Price
T36486	"AA" Tweezers, Indian	EACH	£1.75
T36487	"3" Tweezers, Indian	EACH	£1.75

Brass Tweezers, Bergeon Swiss



Brass is 100% anti-magnetic and is widely used for handling delicate components, especially in watch-making. This alloy cannot be sterilized.

- Bergeon 1064AM
- Length 120mm
- Medium Stout, Fine Tip
- Anti Magnetic
- Brass
- Do not react to acid

PRICE PROMISE GUARANTEE

• Soft metal, good for handling delicate objects

Code	Description	UOM	Price
T1790	"AA" Brass Tweezers, Bergeon Swiss	EACH	£27.50

Brass Tweezers, Dumont Swiss



Brass is 100% anti-magnetic and is widely used for handling delicate components, especially in watch-making. This alloy cannot be sterilized.

- Dumont 5306-1AM-PS
- Length 120mm
- Medium Stout, Fine Tip
- Anti Magnetic
- Brass
- Do not react to acid
- Soft metal, good for handling delicate objects

Code	Description	UOM	Price
T43271	"AM" Tweezers, Dumont Swiss	EACH	£36.75

COATED & TIPPED TWEEZERS

Boxwood Tipped, Dumont



- Pointed or flat tips
- Boxwood tips, non magnetic
- Length 125mm
- Rust proof
- Non magnetic stainless steel tweezers
- Dumont Swiss

Code	Description	UOM	Price
P45954	Flat Boxwood Tipped Tweezers, Dumont	EACH	£49.95
T31403	Pointed Boxwood Tipped Tweezers, Dumont	EACH	£45.25
T31404	Dumoxel Replacement Boxwood Tips	EACH	£24.50

Carbon Fibre Tipped, Horotec



Carbon Fibre - Horotec - Swiss Made

To provide a high strength to weight ratio material. The density of carbon fibre is also considerably lower than the density of steel, making it ideal for applications requiring low weight. High tensile strength, low weight and low thermal expansion.

- Horotec Swiss
- Aluminium body
- Length 130mm

Code	Description	UOM	Price
T20980	Curved, Carbon Fibre Tipped	EACH	£18.50
T20977	Extra Fine, Carbon Fibre Tipped	EACH	£17.95
T20979	Fine, Carbon Fibre Tipped	EACH	£16.25

T20976	Flat Medium, Carbon Fibre Tipped	EACH	£17.95
T20978	Flat Broad, Carbon Fibre Tipped	EACH	£17.95

Carbon Fibre Tipped, Vetus



Carbon Fibre - Vetus - Swiss Quality

To provide a high strength to weight ratio material. The density of carbon fibre is also considerably lower than the density of steel, making it ideal for applications requiring low weight. High tensile strength, low weight and low thermal expansion.

- Carbon fibre tips
- Vetus Swiss quality
- Overall length 130mm
- Stainless steel body

Code	Description	UOM	Price
T39015	Pointed Tips, Vetus	EACH	£4.25
T39014	Rounded Tips, Vetus	EACH	£4.25

Delrin Tipped, Horotec



Delrin - Horotec - Swiss Made

An engineering plastic, a polymer. It is often marketed and used as a metal substitute. Delrin is a lightweight, low-friction, wear-resistant thermoplastic with good physical and processing properties capable of operating in temperatures in excess of 90 degrees celsius (approximately 200 degrees fahrenheit).

- Horotec Swiss
- Aluminium body
- Length 130mm

Code	Description	UOM	Price
T20985	Curved, Delrin Tipped	EACH	£17.95
T20982	Extra Fine, Delrin Tipped	EACH	£17.95
T20984	Fine, Delrin Tipped	EACH	£17.95
T20981	Flat Medium, Delrin Tipped	EACH	£17.95
T20983	Flat Broad, Delrin Tipped	EACH	£17.95

Epoxy Coated



Tweezers - Epoxy Coated

These non-magnetic stainless steel tweezers feature an epoxy coating and may be used for electronics, gemology, jewellery making, hobbyist and watch repair.

- Epoxy coated
- Anti-magnetic
- 140mm overall length
- Made in India

Code	Description	UOM	Price
T36490	Very Fine Tips (SS)	EACH	£1.50
T36488	Fine Tips (3C)	EACH	£1.50
T36489	Broad Tips (2A)	EACH	£1.50

**Epoxy Coated, A\*F Swiss**



Tweezers - Epoxy Coated

These non-magnetic stainless steel tweezers feature an epoxy coating and may be used for electronics, gemology, jewellery making, hobbyist and watch repair.

- A\*F Swiss
- Length 120mm
- Broad tipped
- Plastic coated

Code	Description	UOM	Price
T1789A	Plastic Coated, General Purpose Tweezers, Etic Swiss	EACH	£19.25

**Plastic Tipped**



- Soft plastic tip
- Anti-magnetic
- Prevents scratching of delicate objects
- Made in India

Code	Description	UOM	Price
T36495	130mm Tweezers	EACH	£1.75
T36494	130mm Tweezers, Fine	EACH	£1.75
T36497	160mm Tweezers	EACH	£1.75
T36496	160mm Tweezers, Fine	EACH	£1.75
T36498	160mm Tweezers, Pearl & Stone Gripping	EACH	£1.75

**Vulcanized Fibre Tipped, Horotec Swiss**



Vulcanized Fibre - Horotec - Swiss Made - Antimagnetic

Vulcanized fibre is a laminated plastic composed of only cellulose. The material is a tough, resilient, hornlike material that is lighter than aluminium, tougher than leather, and stiffer than most thermoplastics.

- Anti magnetic
- Nickel body
- Horotec Swiss
- Length 130mm

Code	Description	UOM	Price
T44251	Extra Fine Tips, Vulcanised Fibre	EACH	£28.95
T44152	Fine Tips, Vulcanised Fibre	EACH	£22.95
T44153	Medium Tips, Vulcanised Fibre	EACH	£28.95
T44154	Large Tips, Vulcanised Fibre	EACH	£28.95

**PLASTIC TWEEZERS**



We stock a diverse selection of plastic tweezers in various types and qualities.

Plastic tweezers can be used for the following:

- When changing a watch battery it is essential to use plastic tweezers, using an alternative may damage the watch battery and/or movement due to the contamination of dirt, grease or even magnetizing the watch will cause the movement to malfunction.
- Eliminates the risk of damaging any components when picking (safety pickle only) and handling, repairing or manufacturing.
- Use to place in and remove your items from Acid Pickling solution (P5231). (We only recommend our references T1797 and T1798). Also supplied long copper tweezers for larger items which also encompass a longer reach.
- The plastic compound probe is very useful to move, place and press watch parts whilst repairing watches; hence preventing the watch movement being marked or magnetized.
- Also popular for removing watch parts from chemicals for watch and clock cleaning, such as Horological Essence (Code F2811).

**Component Probe, Bergeon 6436**



Probe - Bergeon Swiss 6436

- Plastic
- Probe for delicate and electrical components
- Pointed one end with 4mm flat at other end
- Length = 135mm
- Ø4mm

Code	Description	UOM	Price
S1551	Component Probe in Plastic, Bergeon 6436	EACH	£2.25

**Component Probe, Bergeon 7010**



Probe - Bergeon Swiss 7010

- In Strengthened Polyamide
- Probe for delicate and electrical components
- Pointed one end with 4mm flat at other end
- Length = 150mm
- Ø5mm

Code	Description	UOM	Price
G34640	Component Probe in Strengthened Polyamide, Bergeon 7010	EACH	£6.95

**Movement & Battery Testing Device**



See Page 739

**Bowed Shaped Set, Indian**



Tweezers - Plastic

- Set of 3 (including large 250mm pair)
- Excellent value, perfect for pickling acid solutions, ultrasonic baths, steam cleaning etc.
- With serrated jaws
- Bowed shape
- Made in India

Sizes include:

- 1 x 140mm
- 1 x 180mm
- 1 x 250mm

Code	Description	UOM	Price
T36089	Plastic Tweezers Set	PACK*3	£1.75

**Chemical Resistance, Bergeon**



Tweezers - Plastic - Bergeon Swiss

- Bergeon 6751.115 & 6751.145
- Strong
- Good Chemical Resistance
- Can be used up to 180°C

Code	Description	UOM	Price
T1797	115mm Plastic Tweezers	EACH	£6.95
T1798	145mm Plastic Tweezers	EACH	£7.65

**General Purpose**



Tweezers - Plastic

- 120mm
- General purpose
- Ridged ends
- Ends can be easily carved with a knife or filed to desired shape to suit your requirements
- Made in India

Code	Description	UOM	Price
T34701	120mm Plastic Tweezers	EACH	£0.20

**General Purpose, A\*F Swiss**



Tweezers - Plastic - A\*F Swiss

- A\*F Swiss
- Length 120mm
- General Purpose Tips
- Broad Taper
- Ends can be easily carved with a knife or filed to desired shape to suit your requirements

Code	Description	UOM	Price
T5485	120mm A*F Swiss, General Purpose Tips	EACH	£1.30

**PRICE PROMISE GUARANTEE** ✓

**Popular with Stabiliser, Indian**



Tweezers - Plastic - With Stabiliser

- 130mm
- General purpose
- Serrated ends
- With stabiliser that prevents tweezers from twisting
- Made in India

Code	Description	UOM	Price
T37828	Plastic Tweezers with Lock	EACH	£1.50

**Spade Tipped**



Tweezers - Plastic - Spade Tips

- Length 110mm
- 3mm spade tips
- Inexpensive to replace if lost or damaged
- Made in India

Code	Description	UOM	Price
T39591	110mm, Spade Tips	EACH	£0.95

**Spade Tipped, Bergeon**



Tweezers - Plastic - Bergeon Swiss - Spade Tips

- Bergeon 6460
- Length 120mm
- 3mm Spade Tips

Code	Description	UOM	Price
T1796	120mm Bergeon Swiss, Spade Tips	EACH	£2.50

**JEWELLERS (INCLUDING DIAMOND & GEMSTONE) TWEEZERS**

- When working with gemstones and other small jewellery findings in jewellery creation or repair, it is essential to have a high class pair of gemstone tweezers on hand
- Great for holding gemstones and diamonds securely, these diamond tweezers come in a wide variety styles to hold gemstones of all different sizes
- These gemmology tools are also great for a watch repairer or jeweller. They have great handling ability, rendering them useful for all small parts such as watch screws, uncut gemstones or findings

**Styles & Types:**

- For Small Size stones
- For Medium Size Stones
- With or without Slide Grip
- Matt Black, Satin Steel Finish or Titanium
- Swiss or Non Swiss Made



**Cousins Jewellers Diamond Tweezers**



- Cousins Diamond Tweezer
- for Small or Medium size Stones
- Serrated Tips
- Regular or with Locking System
- Various Lengths
- Satin, Black & Titanium

Code	Description	UOM	Price
T47026	Small Stones, Black	EACH	£1.50
T6277	Small Stones, Satin	EACH	£0.95
T36491	Medium Stones, Black	EACH	£1.50
T36492	Medium Stones, Black, Locking System	EACH	£1.50
T6278	Medium Stones, Satin, Locking System	EACH	£1.60
T36493	Medium Stones, Titanium,	EACH	£4.95

**Dumont Jewellers Diamond Tweezers**



- Dumont Diamond Tweezer
- Swiss Made
- For Small or Medium size Stones
- Serrated Tips
- Regular or with Locking System
- Length 150mm
- Satin or Black Finish

Code	Description	UOM	Price
T1775	Small Stones, Black	EACH	£13.50
T1776	Small Stones, Black, Locking System	EACH	£18.95
T1772	Small Stones, Satin, Locking System	EACH	£16.65
T1777	Medium Stones, Black	EACH	£13.95
T1778	Medium Stones, Black, Locking System	EACH	£15.95
T1774	Medium Stones, Satin, Locking System	EACH	£17.50

**Swisotech Jewellers Diamond Tweezers**



- Swisotech Diamond Tweezer
- Swiss made
- For small, medium or large size stones
- Serrated tips (serrated)
- Satin textured tips (satin)

- Tips with groove or flat
- Regular or with locking system
- Stainless steel (SS) or Titanium
- 160mm overall length

**Specifications:**

- Tip size, Material (Tip Finish)
- See additional information for full specification

Code	Description	UOM	Price
T44172	Small Stones, SS (Serrated Tips)	EACH	£15.95
T44175	Small Stones, Titanium (Satin Tips)	EACH	£31.95
T44173	Medium Stones, SS (Serrated Tips)	EACH	£15.95
T44170	Medium Stones, SS (Serrated Tips) with Locking System	EACH	£18.50
T44168	Medium Stones, SS (Serrated Tips with Groove)	EACH	£16.95
T44176	Medium Stones, Titanium (Satin Tips)	EACH	£31.95
T44174	Large Stones, SS (Serrated Tips)	EACH	£15.95
T44169	Large Stones, SS (Serrated Tips with Groove)	EACH	£16.95
T44171	Large Stones, SS (Serrated Tips with Groove) with Locking System	EACH	£18.50

**Jewel Picker Upper with Silicone Tips**

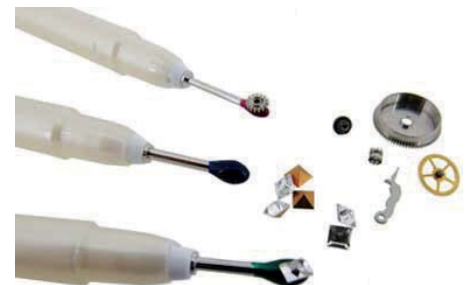

Jewel Picker Upper - Silicone Tips

- A quick and easy way to pick up Jewels and small parts;
- A stone setter's favourite pick your Gem stone up and place into and out of setting jobs with ease
- Reduces the likelihood of dropping small pieces
- 3 sizes: Fine, Medium & Large
- Popular Pen Style
- Very handy to put fine hands and screws on your movements
- You will find your watch parts will not get damaged
- Polished fine parts will not get marked
- Very popular for jewellers, light engineers, model makers and used in arts and crafts

Code	Description	UOM	Price
P32168	Fine Point (Red)	EACH	£4.30
P32169	Medium Point (Blue)	EACH	£4.30
P32170	Large Point (Green)	EACH	£4.75

**Jewellers (All Purpose) Set**



Tweezers - All Purpose - Set of 5

These popular stainless steel tweezers are great for a variety of uses including gemmology, jewellery making and watch repair. This is a great all around set and at a great price for stainless steel tweezers.

- They come in a convenient storage pouch for easy access and organization
- All come with serrated jaws except board tips, packed in a pouch.
- Stainless steel

Set includes:



- 1 x Reverse action, 160mm
- 1 x Straight, 150mm
- 1 x Bent nose, 150mm
- 1 x Mini, 120mm
- 1 x Mini Broad tip, 120mm

Code	Description	UOM	Price
T36499	Jewellers (All Purpose) Set	PACK*5	£3.95

## Jewellers (General Purpose) Tweezers



Used for jewellery repair as well as other applications including as a hobby tool. Ideal to pick up delicate items from hard to reach places.

- Smooth, Pointed Tips
- Length 165mm
- Stainless Steel
- Satin Finish

Code	Description	UOM	Price
T39587	Curved, Pointed Tips	EACH	£1.50

## Jewellers (Diamond) Set



- Set of 4 tweezers
- Amazing value
- Supplied in plastic pouch

Set contains:

- Black tweezers, serrated pointed tips, overall length 165mm
- Stainless steel tweezers, serrated pointed tips, overall length 165mm
- Titanium tweezers, serrated pointed tips, overall length 165mm
- Slide locking, stainless steel tweezers, serrated tips, overall length 165mm

Code	Description	UOM	Price
T39582	Jewellers (Diamond) Set	PACK*4	£5.95

## Tweezers with Shovel



- with Stone Shovel
- Serrated Tips
- Integral 20mm Shovel
- Length 180mm
- for Small Size Stones
- Steel Satin Finish

Code	Description	UOM	Price
T6280	Tweezers with Shovel	EACH	£1.55

## Tweezers with Smooth Tips



- Smooth tipped for stones
- Length 185mm

- For medium size stones
- Steel Satin Finish

Code	Description	UOM	Price
T39585	Tweezers with Smooth Tips	EACH	£1.50

## Tweezers with Blunt Tips & Grip



- Blunt Tips, Ø3.50mm (approx.)
- Smooth tips
- Sliding grip
- Length 160mm
- For all size stones
- Steel satin finish

Code	Description	UOM	Price
T39586	Tweezers with Blunt Tips & Grip	EACH	£1.50

## Paddle Spoon (Pearl & Stone)



Spoon Tipped Pearl Tweezers

- Spoon tipped for gentle but secure grip on porous stones
- Length 160mm
- Ø5mm cupped paddle tips

Code	Description	UOM	Price
T6281	Paddle Spoon (Pearl & Stone)	EACH	£1.95

## Pearl & Stone, Wooden



Wooden tweezers for pearls and stones

- Serrated tips
- Length 205mm
- Ø10mm tips

Code	Description	UOM	Price
T39055	Pearl & Stone Holding Tweezers, Wooden	EACH	£2.65

## Split Ring Tweezers



Tweezers for opening split rings

- Easily open split rings
- No more busted fingernails
- Stainless steel
- Overall length 110mm

Code	Description	UOM	Price
T39592	Split Ring Tweezers	EACH	£1.50

## Wire Claw Tweezers



Tweezers for holding stones and diamonds

- Length: 120 mm
- Diameter: 7 mm

Code	Description	UOM	Price
T1794	Wire 3 Claw Tweezers - Bergeon	EACH	£13.95
T1795	Wire 4 Claw Tweezers - Bergeon	EACH	£17.30
T31316	Wire 4 Claw Tweezers - Cousins	EACH	£1.95

## RING HOLDING TWEEZERS

### Ring Clamp Tweezers, Internal



A popular option to hold rings internally as well as using them to inspect rings; it is also an impressive prop when selling.

It is also ideal to hold pieces when cleaning rings with steam cleaning and ultrasonic machines

Overall length: 130mm

Code	Description	UOM	Price
T6284	Internal Ring Holding Tweezers	EACH	£1.85

### Ring Clamp Tweezers, External



A popular option to hold rings externally as well as using them to inspect rings; it is also an impressive prop when selling. Useful for holding rings making reading hallmarks easier; and is also ideal to hold pieces when cleaning rings with steam cleaning and ultrasonic machines.

Also ideal to hold the bezel on top of your ring mount while you are soldering

For ring shank or head, with slide lock, textured platform plus sculptured tong with inside groove.

- Length = 130mm
- 3mm Ø table

Code	Description	UOM	Price
T6279	External Holding Ring Tweezers	EACH	£3.65

## SOLDERING & REVERSE ACTION TWEEZERS

An essential tool, we have a large soldering tweezers range, capable of tackling any major soldering repair/manufacturing work.

- Fitted with fibre grips for heat insulation whilst soldering
- Reverse grip available so an item can be supported without actually holding the tweezers
- High quality steel used which makes it ideal for soldering jobs

### Cyber-Therm (3000°C) A\*F Swiss



- A\*F Swiss 125.131S
- Length 145mm

Unique Tungsten steel allow resists temperatures up to 3000°C, for up to 5 to 10 minutes.

Handles protected by silicon rubber, heat resistant, insulating sleeves.

Used in jewellery, dental, hobby, optical, medical and watchmaking applications.

Code	Description	UOM	Price
T9575	Cyber-Therm (3000°C) A*F Swiss	EACH	£60.95

**Half Shank Tweezers**



Half Shank Soldering Tweezers

- Designed to hold half & quarter ring shanks in place during soldering and repairs
- Overall length 165mm
- Stainless steel

Code	Description	UOM	Price
T39321	Half Shank Tweezers	EACH	£3.95

**PVC Grip, Regular Action**



- Straight & curved ends
- Regular action
- Insulated with PVC grip
- Perfect for steam cleaning, heating, soldering & setting
- Heat resistant
- Overall length 160mm
- Pack\*2

Code	Description	UOM	Price
T47033	Straight & Curved Tips with PVC Grip	PACK*2	£2.95

**PVC Grip, Reverse Action**



- Straight & curved ends
- Reverse action
- Insulated with PVC grip
- Perfect for steam cleaning, heating, soldering & setting
- Heat resistant
- Overall length 160mm
- Pack\*2

Code	Description	UOM	Price
T47032	Straight & Curved Tips, PVC Grip	PACK*2	£2.95

**Reverse Action, Straight Tips**



Tweezers - Reverse Action

- Reverse action tweezers
- Simple execution
- Stainless steel

Code	Description	UOM	Price
T39583	Round Tips, Reverse Action	EACH	£2.50
T39584	Pointed Tips, Reverse Action	EACH	£1.25

**Regular Action (Insulated), Straight Tips**



- Straight ends
- Insulated
- Heat resistant
- Fibre Grip
- Length 160mm & 200mm

Code	Description	UOM	Price
T31949	160mm Insulated with Straight Tips	EACH	£1.50
T31950	200mm Insulated with Straight Tips	EACH	£1.75

**Reverse Action (Insulated), Curved Tips**



- Curved ends
- Stainless steel or titanium tips
- Insulated
- Heat resistant
- Fibre Grip
- Length 160mm

Code	Description	UOM	Price
T4914	Curved Tips, Stainless Steel	EACH	£1.25
T45551	Curved Tips, Titanium	EACH	£5.25

**Reverse Action (Insulated), Shaped Tips**



- Shaped ends
- Holds a variety of shaped objects
- Stainless steel
- Insulated
- Heat resistant
- Fibre Grip
- Length 160mm
- Supplied in plastic wallet
- Pack\*3

Code	Description	UOM	Price
T47027	Shaped Tips Set	PACK*3	£3.95

**Reverse Action (Insulated), Straight Tips**



- Straight ends
- Stainless steel or titanium tips
- Insulated
- Heat resistant
- Fibre grip
- Length 160mm

Code	Description	UOM	Price
T4913	Pointed Tips, Stainless Steel	EACH	£1.25
T45550	Straight Tips, Titanium	EACH	£5.25

**Reverse Action (Insulated), Straight Tips with Stand**



Modified Soldering Tweezer with fibre grips with added attachment stand. Helps you to place the tweezer on your workbench without using your hands to hold the same.

- Straight ends
- Insulated
- Heat resistant
- Fibre Grip
- Length 160mm

Code	Description	UOM	Price
T20212	Straight Tips, Reverse Action with Stand - Insulated	EACH	£2.25

**Soldering Tweezer Set**



- Set of 4 tweezers
- Amazing value
- Supplied in plastic pouch

Set contains:

- Reverse action tweezers, serrated pointed tips, overall length 165mm
- Reverse action tweezers, serrated curved tips, overall length 165mm with insulated fibre grip
- Copper tweezers, smooth tips, overall length 170mm
- Multi-utility tweezers, smooth tips, overall length 180mm

Code	Description	UOM	Price
T39580	Soldering Tweezer Set	PACK*4	£4.95



**Soldering Third Hand on Solder Board**

**See Page 1012**

**VICES & CLAMPS**

**CLAMPS, BENCH, PEARL & TOOLMAKERS**

**C Clamps**

Mini 2 pieces Universal Function Workshop Clamps

Hold/secure your finer workshop pieces with these solid steel construction mini clamps

- Fine cut acme thread for smooth and fast movement
- Ø22mm swivel disc plate to correct the angle applying even pressure
- A favourite with miniature model makers, jewellery, crafts, clock restorers
- Also available various sized G clamps see item codes C33515 to C33518



Features:

- Will hold items thickness 0 to 40mm
- Weight: 120 grams for the pair

Code	Description	UOM	Price
V33905	C Type Clamps	PACK*2	£3.95

**G Clamps**



Faithful G-Clamps - General Purpose Workshop Clamps

A G-Clamp is used by means of turning the screw through the bottom of the frame until the desired state of pressure or release is reached.

In the case that the clamp is being tightened, this is when the objects being secured are satisfactorily secured between the flat end of the screw and the flat end of the frame.

If the clamp is being loosened, this is when a sufficient amount of force is released to allow the secured objects to be moved.

- Ribbed 'T' section ductile iron construction.
- Deep cut Acme threads for smooth and fast movement.
- Broad swivel shoe adjust to the correct angle to apply even pressure.
- Powder coated to protect from corrosion.
- Clamp C33518 is ideal to use with Ring Stretcher R4920, will stretch rings with accuracy in an automated action.
- A student/hobbyists favourite to clamp onto bench pegs (B4228).

Weights:

- C33515 - 550g
- C33516 - 500g
- C33517 - 854g
- C33518 - 1.1kg

Code	Description	UOM	Price
C33515	50mm G Clamp	EACH	£4.35
C33516	75mm G Clamp	EACH	£5.75
C33517	100mm G Clamp	EACH	£7.95
C33518	150mm G Clamp	EACH	£11.50

**Pearl Drilling Vice**

Cousins Material House Pearl Drilling Vice

When drilling pearls to make jewellery holding the item can be problematic to drill such as slipping.

- Firmly secure pearls for easy drilling.
- Cup shaped nylon jaws, which will not mark the item with a superb fit.
- Other shapes like round and oval items can also be drilled using this vice.
- Its body and hand closing jaw knob are both made from steel.



Size & Weight

- 80mm x 50mm x 20mm
- Largest pearl/object that can be held is 15mm in diameter.
- Made in India
- Weight 105gms

Code	Description	UOM	Price
V31267	Pearl Drilling Vice	EACH	£7.50

**Pearl & Bead Drilling Clamp**



Drilling pearls/beads can be a fiddly process because they are hard to hold in your hand and also warm up with the cutting friction of the drill.

This handy little tool solves the problem by simply clamping the pearl/bead holding it firm and securer while drilling.

- Spring loaded ridged locknuts butts provide quick clamping and releasing action
- With thirteen round clamping holes, sizes: 6.3, 6, 5, 4.4, 4, 3.5, 3, 2.5, 2, 1.3mm
- Hold up to Ø8mm
- Made in steel chrome plated

Size: 40 x 30mm

Weight: 35 grams

Code	Description	UOM	Price
V34931	Pearl & Bead Drilling Clamp	EACH	£3.95

**Toolmakers Clamps**

This clamp is extremely useful for holding work together when drilling, tapping and other machining operations.

Manufactured from case hardened steel for strength and equipped with a spring clip and a retaining ring which holds the loose jaw in place when the clamp is being adjusted.



- Size 30mm (1¼" inch) capacity
- Weight: 120g
- "Faithfull" brand quality tool

Code	Description	UOM	Price
C33514	30mm Toolmakers Clamp	EACH	£4.05

**ENGRAVERS VICES**

**Jewellers Engravers Vice**

Popular vices for engraving, model making, sculpture making are just some examples of this vice:

- The adjustable ball swivel enables versatile use, allowing repositioning of work as frequently as required, etc.
- Four holding pins are included slot into any of the sixty position holes allowing any different shaped items to be used on this tool.
- Open/close the vice jaws for different sized objects using the easy hand operated turning knob.
- Complete metal construction.

**Jewellers Engravers Vice, on Stand**



Size and weight:

- 95mm x 64mm x 70mm
- Top plate, pin hole table 50mm
- Jaws open to 20mm
- Maximum size to hold objects 60mm x 40mm
- Bottom of the stand has a rubber, none slip ring fitted and prevents the base from moving
- Weight 590g

Code	Description	UOM	Price
V31291	Jewellers Engravers Vice, on Stand	EACH	£16.25

**Tube Cutting Jig**



Ref: T42909  
See Page: 832

**Jewellers Engravers Vice, Hand Held**



- Size and weight:
- 130mm x 64mm x 70mm
  - Top plate, pin hole table 50mm
  - Jaws open to 20mm
  - Maximum size to hold objects 60mm x 40mm
  - Wooden holding handle which can be unscrewed and secured in a vice
  - Weight 190g

Code	Description	UOM	Price
V1824	Jewellers Engravers Vice, Hand Held	EACH	£8.25

**Jewellers Engravers Vice, Hand Held for Rings**



- Size and weight:
- Overall length 150mm
  - Handle diameter Ø25mm
  - Top plate table Ø25mm
  - Top plate table opens up to Ø35mm
  - Maximum size to hold objects 30mm x 30mm
  - Wooden holding handle which can be unscrewed and secured in a vice
  - Supplied with 8 pins
  - Weight 190g

Code	Description	UOM	Price
R47021	Jewellers Engravers Vice, Hand Held for Rings	EACH	£7.95

**VICES (BENCH) & VICE JAWS**

A large selection of bench vices are available. Our range is sourced from all over the world giving our customer excellent choice in price and quality.

Vices have an array of advantages which make the working process a faster and uncomplicated one in filing, tapping, hammering, soldering, forming, polishing, twisting wire/sheet, etc.



**Clamp On - 1" (28mm) Jaw**

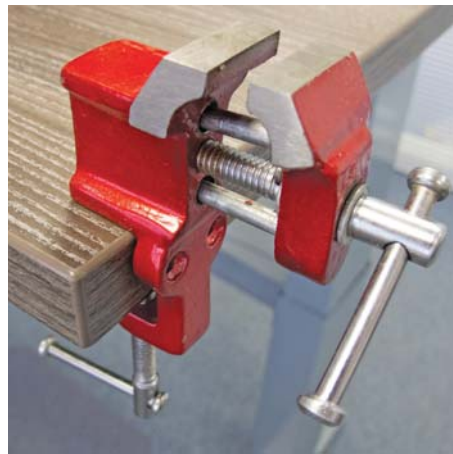

- Mini - Table Vice - Clamp On - Fixed Head
- The clamp on vice feature permits the user to move the vice to different areas of the workshop
  - Portable and easy to move
  - Rigid cast iron construction
  - Enamelled, hand painted finish
  - Made in India
- Dimensions:
- 130 x 90 x 30mm
  - Jaw width 28mm
  - Maximum opening 26mm
  - Clamp fitting table maximum 30mm
  - Weight 365g

Code	Description	UOM	Price
V39595	1" Jaw, Clamp On Fixed Head "Mini" Bench Vice	EACH	£3.95

**Clamp On - 1½" (40mm) Jaw**



- Mini - Table Vice - Clamp On - Fixed Head
- The clamp on vice feature permits the user to move the vice to different areas of the workshop.
  - Rigid cast iron construction.
  - Enamelled, hand painted finish.
  - Made in India
- Dimensions:
- 120 x 40 x 120mm
  - Jaw width 38mm
  - Maximum opening 30mm
  - Clamp fitting table maximum 35mm
  - Weight 650g

Code	Description	UOM	Price
V5343	1½" Jaw, Clamp On Fixed Head Bench Vice	EACH	£9.95

**Clamp On - 1½" (40mm) Jaw (Model Craft)**



- Mini Vice - Clamp On - Fixed Head - Model Craft
- The mini vice is made from aluminium alloy, combining strength and lightness.
- Jaw Width: 40mm
  - Jaw Capacity: 30mm
  - Can be attached to benches up to 20mm thick
  - Small, portable and strong
  - Aluminium alloy
  - Model Craft
- Dimensions:
- 115 x 70 x 40mm (height x width x depth)
  - Weight 350g

Code	Description	UOM	Price
V44332	1½" Jaw, Clamp On Bench Vice, Model Craft	EACH	£4.95

**Clamp On - 2" (50mm) Jaw, Rotating**



- Table Vice - Clamp On - Rotating - Fixed Head
- Rotates a full 360 degrees to a workable position and then should be locked with the lever.
  - The clamp on vice feature permits the user to move the vice to different areas of the workshop.
  - Rigid cast iron construction.
  - Enamelled, hand painted finish.
  - Made in India
- Dimensions:
- 140 x 60 x 130mm
  - Jaw width 50mm
  - Maximum opening 40mm
  - Clamp fitting table maximum 35mm



• Weight 1.1kg

Code	Description	UOM	Price
V5345	2" Jaw Clamp On Rotating Head Bench Vice	EACH	£14.95

## Clamp On - 2½" (60mm) Jaw (Model Craft)



Bench Vice - Clamp On - Fixed Head - Model Craft  
Aluminium alloy bench vice with crossed jaws. Providing a secure, strong and lightweight bench vice all in one

- Jaw Width: 60mm
- Jaw Capacity: 50mm
- Can be attached to benches up to 25mm thick
- Aluminium alloy
- Jaws have cross cut surface for better grip
- Model Craft

Dimensions:  
• 140 x 120 x 60mm (height x width x depth)  
• Weight 380g

Code	Description	UOM	Price
V44331	2½" (60mm) Jaw, Clamp On Vice	EACH	£6.50

## Clamp On - 3" (75mm) Jaw, Multi Angle



Bench Top - Multi Angle - Clamp On - Enamelled Aluminium

The ball socket manufacture of this multi-purpose vice enables complete flexibility for filing, sawing, soldering, polishing, painting models, engraving drilling and grinding.

- Jaw Width: 75mm
- Jaw Capacity (without rubber jaws): 55mm
- Jaw Capacity (with rubber jaws): 50mm
- Head Rotation: 360 degrees
- Tilt positions: 0 – 90 degrees
- The mounting clamp opens as wide as 2" which will

mount on the majority of workbenches, while the rubber pad protects the bench's surface from marking

- The ball sits firmly in the socket whilst allowing the user freedom to reposition work as frequently as required
- The jaws are covered with detachable, protective inserts to avoid damaging the held pieces.
- The jaws have grooves specifically ground in to hold tube and sheet
- Made of heavy cast aluminium with an enamel-coated body and cold rolled steel screws

Dimensions:  
• 300 x 135 x 75mm  
• Weight: 1kg

Code	Description	UOM	Price
V32982	3" (75mm) Jaw, Clamp On Rotating Head Bench Vice	EACH	£12.95

## 3" (75mm) Jaw, Clamp On, Multi Angle (Model Craft)



Bench Top - Multi Angle - Clamp On - Model Craft

The ball socket manufacture of this multi-purpose vice enables complete flexibility for filing, sawing, soldering, polishing, painting models, engraving drilling and grinding. Giving you access to the area required all the while holding the item securely with the greatest possible ease

- Jaw Width: 75mm
- Jaw Capacity (without rubber jaws): 55mm
- Jaw Capacity (with rubber jaws): 50mm
- Head Rotation: 360 degrees
- Tilt positions: 0 – 90 degrees
- The mounting clamp opens as wide as 2.5" (65mm) which will mount on the majority of workbenches, while the rubber pad protects the bench's surface from marking
- The ball sits firmly in the socket whilst allowing the user freedom to reposition work as frequently as required
- The jaws are covered with detachable, protective inserts to avoid damaging the held pieces
- The jaws also have vertical and horizontal V-Grooves ideal for holding rods, wire or circular objects
- Die cast aluminium
- Modelcraft range

Dimensions:  
• 260 x 160 x 80mm  
• Weight: 800g

Code	Description	UOM	Price
V44305	3" (75mm) Jaw, Clamp on Rotating Head Bench Vice	EACH	£9.75

**PRICE PROMISE GUARANTEE** ✓

## Screw Down - 1" (28mm) Jaw



Mini - Table Vice - Clamp On - Fixed Head

- Screw down vice giving permanent stability and strength
- Rigid cast iron construction
- Enamelled, hand painted finish
- Made in India

Dimensions:  
• 75 x 50 x 50mm  
• Jaw width 22mm  
• Maximum opening 20mm  
• Weight 300g

Code	Description	UOM	Price
V39594	1" Jaw, Screw On Fixed Head "Mini" Bench Vice	EACH	£3.95

## Screw Down - 1½" (38mm) Jaw

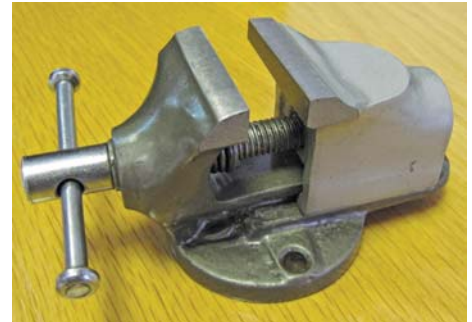

Mini - Table Vice - Screw Down - Fixed Head

- Secure on your work surface with screws bottom cast base has 2 holes
- Sturdy cast iron construction.
- Enamelled hand painted finish.
- Made in India

Dimensions:  
• 120 x 55 x 55mm  
• Jaw width 40mm  
• Maximum opening 30mm  
• Weight 610g

Code	Description	UOM	Price
V5344	1½" (38mm) Jaw, Top Mount Fixed Head Bench Vice	EACH	£10.95

## Screw Down - 1¾" (45mm) Jaw, Watchmakers

Watchmakers - Bench Vices - Removeable - Fixed Head

Precision made small vice featuring a robust bench fixable sole plate (included) and slide clamp release facility for removal of vice head (complete with job) for easy access, further work and close inspection etc.

Substantially rigid all steel manufacture with absolutely parallel 45mm wide jaws moving

on a machined dovetail slide and opening to a maximum of 35mm.

A perfect partner for jewellers, watchmakers and precision engineers. Indiscernible in quality and finish from the Bergeon equivalent costing over twice the price.

### Watchmakers Bench Vice



- Non Swiss
- Width of jaws 50mm
- Sizes: 110mm x 35mm x 70mm
- Jaw opening 0 to 35mm
- Very good quality
- Fawn coloured enamel (fired)
- Weight 1.1kg
- Held firmly in place by the screw down sole plate (included)
- Quick release mechanism for rapid removal from work surface
- Perfectly Smooth jaws
- Indiscernible in quality and finish from the Bergeon equivalent costing over twice the price
- Please note V1826A Vice sole plate is not compatible with this vice

Code	Description	UOM	Price
V9692	Watchmakers Bench Vice	EACH	£49.95

### Watchmakers Bench Vice - Bergeon Swiss



- Bergeon 2021
- Width of jaws 45mm
- Sizes: 110mm x 35mm x 70mm
- Jaw opening 0 to 35mm
- Very fine quality
- Fawn coloured enamel (fired).
- Only the sole plate is permanently screwed on to the bench (included)
- Smooth absolutely parallel jaws
- Weight 1.2kg

Code	Description	UOM	Price
V1826	Watchmakers Bench Vice - Bergeon Swiss	EACH	£199.95

### Watchmakers Bench Vice Sole Plate

- For vice V9692



Code	Description	UOM	Price
V46461	Watchmakers Bench Vice Sole Plate	EACH	£27.50

### Watchmakers Bench Vice Sole Plate, Bergeon Swiss



- Bergeon 2021 (V1826)
- Replacement Sole Plate
- Weight 85g

Code	Description	UOM	Price
V1826A	Watchmakers Bench Vice Sole Plate, Bergeon Swiss	EACH	£30.50

### Screw Down - 2" (50mm) Jaw, Rotating



Table Vice - Screw Down - Rotating - Fixed Head

- Secure on your work surface with screws bottom cast base has 3 holes
- Sturdy cast iron construction
- Enamelled hand painted finish
- Made in India

Dimensions:

- 120 x 70 x 75mm
- Jaw width 50mm
- Maximum opening 30mm
- Weight 1Kg

Code	Description	UOM	Price
V36465	2" (50mm) Vice with Swivel Base	EACH	£9.95

### Screw Down - 4" (100mm) Jaw, Heavy Duty



Workshop Bench Vice - Heavy Duty - Screw Down - Fixed Head

A compact heavy duty workshop vice suitable for use by both the amateur and professional craftsman. The body and slide have been ground to exacting standards and feature a machined anvil and replaceable steel jaw plates. High grade ACME thread main screw with the capacity to clamp over one ton between the jaws.

A safety stop prevents the slide from being accidentally separated from the body.

Dimensions:

- Jaw width 100mm
- Maximum opening 100mm

- Weight 8Kg

Code	Description	UOM	Price
V33153	4" (100mm) Jaw, Heavy Duty Workshop Vice	EACH	£36.95

### Suction Base - 1½" (38mm) Jaw



Mini - Table Top - Suction Vice - Fixed Head

- Vice enables complete flexibility for filing, sawing, soldering, polishing painting models, engraving drilling and grinding.
- Small compact fine component holding vice
- No screws move around any ware needed
- The lever-operated suction cup holds tightly and instantly
- Best used on non-porous smooth surfaces such as glass, metal and laminated surfaces such as Formica.
- Aluminium jaws fitted for sturdy item holding
- Made from light weight plastic with metal components

Size and weight:

- 85mm x 70mm x 70mm
- Jaw size 38mm (1½")
- Max opening: 30mm
- 135grms

Code	Description	UOM	Price
V32981	1½" Jaw, Suction Base "Mini" Bench Vice	EACH	£3.50

### Suction Base - 2¾" (70mm) Jaw



Bench Top - Multi Angle - Suction Base - Model Craft

The ball socket manufacture of this multi-purpose vice enables complete flexibility for filing, sawing, soldering, polishing, painting models, engraving drilling and grinding. Giving you access to the area required all the while holding the item securely with the greatest possible ease

- Jaw Width: 70mm
- Jaw Capacity (without rubber jaws): 70mm
- Jaw Capacity (with rubber jaws): 65mm
- Head Rotation: 360 degrees
- Tilt positions: 0 – 90 degrees
- Suction base ensures the vice is held firmly in position, whilst delivering the ability to re-locate the vice anywhere that it is needed, or simply out of the way!
- The ball sits firmly in the socket whilst allowing the user freedom to reposition work as frequently as required
- The jaws are covered with detachable, protective inserts to avoid damaging the held pieces
- The jaws also have vertical and horizontal V-Grooves ideal for holding rods, wire or circular objects

# VICES & CLAMPS

- Die cast aluminium
- Modelcraft range

Dimensions:  
 • 195 x 130 x 110mm (Height x width x depth)  
 • Weight: 1.3Kgg

Code	Description	UOM	Price
V44333	2¾" (70mm) Jaw Suction Base Vice	EACH	£17.95

## Vice Jaws - Foredom



"Soft Jaws" bench vice pads attach to any 3" or 4" Vice with magnetic strips.

- Foredom A-SJ35

They have cushioned pads made of resilient ethylene vinyl acetate that grip odd shapes and prevents marring of polished or painted surfaces and threaded parts.

Code	Description	UOM	Price
FDASJ35	Vinyl Acetate Foredom Soft Jaws	EACH	£8.95

## Vice Jaws - Magnetic



Aluminium vice jaws with leather face protectors.

- Protect your work from getting unnecessary, unsightly vice marks
- An inexpensive and vital piece of equipment for any workshop that deals with delicate items in manufacture or repair
- Magnetic backs enabling easy on/off application as well as added strength and stability

Size: 90 x 35mm

Code	Description	UOM	Price
V36090	Vice Jaws, Universal, Leather	PACK*2	£3.75

## VICES (HAND-HELD)

A large selection of hand held vices are available. Our range is sourced from all over the world giving our customer excellent choice in price and quality.

Vices have an array of advantages which make the working process a faster and uncomplicated one in filing, tapping, hammering, soldering, forming, polishing, twisting wire/sheet, etc.

www. Online Discounts

## 10mm Jaw Width, Indian



Hand held, hollow vice for gripping small components e.g. pins, wire, rods etc.

- 10mm Jaw width
- Smooth Jaw
- Length 125mm
- Hole through the centre of the handle to accept long pins and wire
- Maximum jaw opening 3mm
- Steel, knurled handle
- Weight 100g

Code	Description	UOM	Price
V39598	10mm Jaw Width, Indian	EACH	£3.95

## 12.5mm Jaw Width, Indian



Hand Held Vice for gripping small components e.g. pins, wire, rods etc.

- 12.5mm Jaw Width
- Smooth Jaw
- Length 150mm
- Hole through the centre of the handle to accept long pins and wire
- Maximum Jaw Opening 5mm
- Wooden Handle
- Weight 90gms

Code	Description	UOM	Price
V32161	12.5mm Jaw Width, Indian	EACH	£2.95

## 15mm Jaw Width with Rotating Handle



Hand vice for holding, bending and twisting your workshop materials

- Handle adjustment rotation jaw open and close action
- For the jeweller, silversmith, arts craft, contemporary jeweller, model makers and light engineers
- Compatible wooden handle
- Quality steel vice jaws and body

150 grams

Code	Description	UOM	Price
V31882	15mm Jaw Width with Rotating Wooden Handle, Indian	EACH	£6.75

## 16mm Jaw Width, German



- 0-6mm Capacity
- Jaw width 15 mm.
- Overall length 120 mm
- Lancashire style

- Made in Germany

Code	Description	UOM	Price
P1221	16mm Jaw Width, German	EACH	£22.50

## 25mm Jaw Width, Indian



- 3 inch
- 25mm wide serrated spring loaded jaws
- Opening to max 15mm capacity
- Length 8cm
- Weight 180g

Code	Description	UOM	Price
V9827	25mm Jaw Width, Indian	EACH	£3.30

## 25mm Jaw Width, Indian



- 6½ inch
- Length 16.5cm
- Weight 230g
- 25mm wide smooth spring loaded jaws and central "V" groove, opening to 15mm max capacity and featuring a sealed wooded handle for comfortable grip.

Code	Description	UOM	Price
V9829	25mm Jaw Width, Indian	EACH	£8.75

## 35mm Jaw Width, Indian



- 4 inch
- 35mm wide serrated spring loaded jaws
- Opening to max 20mm capacity
- Length 10cm
- Weight 260g

Code	Description	UOM	Price
V9828	35mm Jaw Width, Indian	EACH	£4.95

**35mm Jaw Width, Brass**



- Overall length: 135mm
- 35mm wide, square brass jaws
- Brass jaws for more delicate work, softer metal will not mark your pieces as easily
- With v groove
- Opening to max 45mm capacity
- Knurled handle
- Length 10cm
- Weight 140g

Code	Description	UOM	Price
V39597	35mm Jaw Width, Indian, Brass Jaws	EACH	£6.95

**VICES (MACHINE / TOOLMAKERS)**

For drilling, light milling, vertical and horizontal work. An excellent range gives you the optimum choice for your workshop. Various levels of gripping power and capacity ensure you will be able to select the machine vice that is right for you.

- Smooth action, durable and precision manufactured
- Proxxon, Foredom and non-branded available

**Foredom Machine Vice**

These mini vices are available for finer work. They are light weight and more easily transferable.

- Hold fine items with accuracy and precision
- Excellent for the fine drilling

**32mm Jaw Width, Zinc Die Cast Vice**



Foredom A-F37200.

Zinc die cast mini machine vice firmly grasps small workpieces for precision drilling on the table top.

Has horizontal and vertical "V" grooves for holding small round pieces and slots in the base for mounting to drill press table slots. (mounting hardware included).

Exterior dimensions: 4 1/4" Long x 2 3/8" wide x 1 1/2" High.  
Jaw Width: 1 1/4"  
Jaw Capacity: 1 1/2"



Jaw Height: 1/2"  
Mounting slots 11/64" wide x 1 7/8" long.

Code	Description	UOM	Price
FDAF37200	32mm Jaw Width, Zinc Die Cast Vice	EACH	£17.65

**45mm Jaw Width Plastic Vice**



Foredom A-F37210.

Plastic mini machine vice is great for holding gemstones, shell and other materials that require water during the drilling or shaping process.

Stainless steel threaded shaft for advancing jaw will not rust.

Exterior dimensions: 4 1/4" Long x 3 1/8" wide x 1 3/4" High.  
Jaw Width: 1 3/4"  
Jaw Capacity: 1 5/8"  
Jaw Height: 3/4"  
Mounting holes: 15/64"

Code	Description	UOM	Price
FDAF37210	45mm Jaw Width Plastic Vice	EACH	£14.75

**Proxxon Machine Vice**

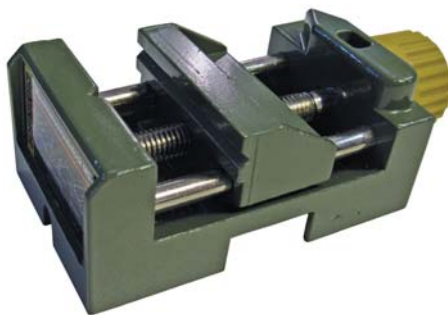

- Incorporates vertical and horizontal v-slots for holding round work pieces
- Jaw width of 50mm (2") and height of 10mm
- Maximum clamping width of 34mm
- Made speciall for the TBM 220 drill (Code D9743)
- Specially slotted for the fence on the TBM drill press to facilitate controlled and accurate work

Code	Description	UOM	Price
D9746	50mm Jaw Width Machine Vice	EACH	£12.50

**PRICE PROMISE GUARANTEE**

**Cousins Euro File Set**

See Page 865



**WATCH AUTOMATIC ROTOR WEIGHT BOLT TOOLS**

**Multi-Collet (Various Calibres), Bergeon**



Oscillating Rotor Weight Lock & Release Tool - Multi-Collet - Bergeon

- Bergeon 6923
- To release and lock the oscillating weight (rotor)
- Two heads included
- Head (A) - Ø10.30mm For ETA 2890 series, including 2892, 2893, 2894, 2895, 2896 & 2897
- Head (B) - Ø7.00mm For Valjoux 7750 & 7770 Valgrange A07111, A07161 & A07271
- Heads also available separately

Video Link: Oscillating Rotor Weight Lock & Release Tool

Code	Description	UOM	Price
W15208	Multi-Collet (Various Calibres), Bergeon	EACH	£99.95
W40006	Head A - ETA 2890 Series	EACH	£37.85
W40007	Head B - Valjoux 7750, 7770 & ETA A07 Series	EACH	£37.85

**Multi-Collet (Various Calibres), Horotec**



Horotec 03.675 - Swiss Made

Tool for assembling/disassembling weight bolts.

- To release and lock the oscillating weight (rotor)
- Two heads included
- For ETA 2890 series, including 2892, 2893, 2894 & 2895
- ETA 2000.1
- Valjoux 7750 & 7770, Valgrange A07111, A07161 & A07271

Code	Description	UOM	Price
W18532	Multi-Collet (Various Calibres), Horotec	EACH	£62.75

**WATCH BALANCE (ESCAPEMENT) TOOLS**

**Balance Holding Tool**

- Bergeon 7990
- Support for cleaning the impulse pin
- Holds the balance without damaging the hairspring
- No need to remove the balance bridge
- Diameter: Ø25mm
- Tapered slot, from Ø5 to Ø9mm wide



Code	Description	UOM	Price
B39562	Balance Holding Tool	EACH	£11.95



## Balance & Hairspring Holding Tool

- Bergeon 30106
- Diameter: 35 mm
- With holes diameter 0.60mm to 2.80mm
- Tapered slot
- In nickeled brass



Code	Description	UOM	Price
B0040	Balance & Hairspring Holding Tool	EACH	£24.95

## Balance Cock Curving Tool



- Bergeon 5432A
- Balance Cock Curving Tool

Code	Description	UOM	Price
B0039	Balance Cock Curving Tool, Bergeon 5432A	EACH	£57.95

## Balance Hairspring Collet Tightening and Reaming Tool

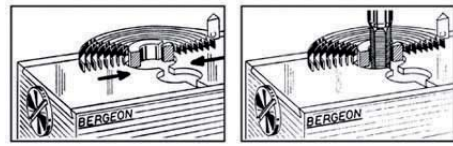

With 5 different notches for tightening all sizes of hairspring collets and for reaming.

- Bergeon 3007
- 70g

Code	Description	UOM	Price
C22531	Balance Hairspring Collet Tightening and Reaming Tool	EACH	£89.95

## Balance Bridge Holding Tool



Simple but practical

To hold the wristwatch balance bridge (via the bridge screw hole) for inspection and correction of the hairspring whilst avoiding polluting the staff with oil.

- For holding bridge with balance attached while putting it in beat
- Straightening kinks in hairsprings
- Under-cutting screws
- Removing or adding timing washers, etc.

- Bergeon Swiss or unbranded

Code	Description	UOM	Price
B15259	Balance Hairspring Holding Tool	EACH	£3.35
S44355	Balance Bridge Holding Tool, Bergeon Swiss	EACH	£16.95

## Balance Screw Holders, Set



Ideal tool for holding and removing watch balance screws after they have been loosened with a screwdriver. Also allows adjustments and inspection without removing the screw from the holder.

- Bergeon 2565
- Set of 8
- With sliding grips
- Overall length 100mm
- Sizes include: Ø0.25, 0.30, 0.35, 0.40, 0.45, 0.50, 0.60 & 0.70mm
- Excellent for balance & small screws

Individual Replacement Sizes Available.

Code	Description	UOM	Price
B4180	Balance Screw Holder Set, Bergeon	PACK*8	£249.95
B0042A	Ø.30mm Balance Screw Holder, Bergeon	EACH	£39.95
B0042B	Ø.35mm Balance Screw Holder, Bergeon	EACH	£39.95
V39479	Universal (fine tip) Balance Screw Holder, India	EACH	£1.95

## Balance Staff Pivot Straightening Tool



Seitz Precision Tool for Straightening Balance Staff Pivots

Allows the pivots to be straightened without breaking due to a control device as well as a screw fitted with a stop.

- Bergeon 30350.D.02
- 41 Jewelled Holes
- Ø0.07 - Ø0.15mm
- Progression 0.025mm
- Detailed Operating Instructions
- 100g

Code	Description	UOM	Price
B34575	Seitz Balance Staff Pivot Straightening Tool	EACH	£445.00

## Lever for Hairsprings



Bergeon 5430

- For lifting under the hairspring collet
- 1.80mm tip breadth
- Red plastic handles

Code	Description	UOM	Price
L0902	Lever for Hairsprings	PACK*2	£36.50

## Poising Tool



- Bergeon 2802-LN-MD
- Extra perfect finish
- High precision
- Spirit level Ø18mm
- Spirit level can be placed on the jaws
- Razor shaped ruby jaws
- Jaws 15mm length
- Tool with jaws without notch.
- Three adjustable legs

Code	Description	UOM	Price
P1256	Poising Tool, Bergeon 2802-LN-MD	EACH	£349.95

## Roller Adjusting Tweezers



- Bergeon 4852
- Tweezers to turn and remove rollers
- Gently grips the roller for repositioning
- Various diameters for all roller sizes
- In nickel plated brass

Code	Description	UOM	Price
R1463	Roller Adjuster Bergeon 4852	EACH	£51.95

## Roller Remover



- Gently removes the friction fit roller from the staff, for replacement and repositioning
- V slots between hub of balance staff and seat of roller
- Slight pressure on sides of tool is sufficient to lift roller from balance seat
- Due to the manufacturers finishing the actual roller removing jaws may need filing and burnishing to suit

• Made in India

Code	Description	UOM	Price
R38801	Roller Remover	EACH	£3.50

### Roller Remover, Bergeon Swiss



- Bergeon 2810
- Gently removes the friction fit roller from the staff, for replacement and repositioning
- V slots between hub of balance staff and seat of roller
- Slight pressure on sides of tool is sufficient to lift roller from balance seat
- Extra fine jaws permit work on both small and standard sizes

Code	Description	UOM	Price
R1462	Roller Remover, Bergeon Swiss	EACH	£15.25

### Roller Remover with Punches, Bergeon Swiss

- Watch balance roller remover with 2 punches
- Punches with Ø0.10 & Ø0.20mm holes
- Stainless steel jaws to hold the balance
- Roller seat fits the V slot jaws & using slight pressure on the punch the roller is removed
- Steel body
- Bergeon 30070
- Swiss made



Code	Description	UOM	Price
R48644	Roller Remover with Punches, Bergeon 30070	EACH	£68.95
R48645	Ø0.10mm Punch	EACH	£10.75
R48646	Ø0.20mm Punch	EACH	£10.75
R48647	Jaw Plate for Roller Remover	EACH	£19.25

### Stud Holder Tool



- Bergeon 30207
- Hairspring stud holder tool
- For secure anchoring of the stud during pinning

Code	Description	UOM	Price
S1634	Stud Holders Tool, Bergeon	EACH	£127.50

### Truing Calipers

Balance (Escapement) - Truing Calipers

For checking the balance wheel is sitting true on the balance staff. By gently & slowly

spinning the balance you can inspect & check to ensure a perfect fit.

Click website "More Information" & "PDF's" for full specification.

### Truing Calipers, Bergeon 1883



- Large model with parallel opening
- With slide, carefully Made
- Pivot protectors in steel
- 1 hole Ø0.15mm
- 1 hole conic.
- Maximum opening 14mm

Code	Description	UOM	Price
C6119	Truing Calipers, Bergeon 1883	EACH	£149.95

### Truing Calipers, Bergeon 4000



- Light Type
- For timer
- Pivot protectors in steel
- Simpler alternative to Bergeon 1883
- Maximum opening 11mm

Code	Description	UOM	Price
C0293	Truing Calipers, Bergeon 4000	EACH	£35.50

### Truing Calipers, Bergeon 5896



- "Lyre" Truing Caliper
- Brass sanded, chrome plated
- Jewelled pivot protectors
- Holes: Ø0.15mm
- Maximum opening 11mm

Code	Description	UOM	Price
C0294	Truing Calipers, Bergeon 5896	EACH	£59.95

## WATCH BARREL ARBOR TOOLS

### Barrel Arbor Holders



- Bergeon 30610 +
- Barrel arbor holder

- Slide locking jaw
- Length 120mm
- Chrome plated bow and handle
- For checking security and condition of watch mainsprings

Code	Description	UOM	Price
B0043E	Ø0.75mm Barrel Arbor Holder	EACH	£38.50
B0043D	Ø1.00mm Barrel Arbor Holder	EACH	£38.50
B0043C	Ø1.25mm Barrel Arbor Holder	EACH	£38.50
B0043B	Ø1.50mm Barrel Arbor Holder	EACH	£38.50
B0043A	Ø1.75mm Barrel Arbor Holder	EACH	£38.50

### Barrel Cover Closer Tool

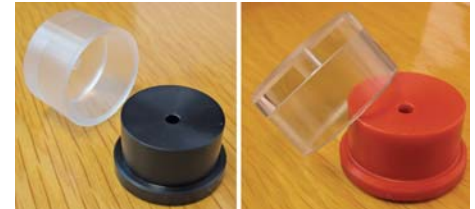

- Simple to use
- Close the barrel cover easily
- Use the same amount of pressure across the circumference
- Avoids damaging the barrel's profile
- Italian made or Bergeon Swiss (Bergeon 7922)

Code	Description	UOM	Price
B39009	Barrel Cover Closing Tool, Bergeon Swiss	EACH	£16.95
B12036	Barrel Cover Closing Tool, Italian	EACH	£22.95

## WATCH BEZEL REMOVING & FITTING

Whether your removing "Generic" or "Top Swiss" watch bezels, great tools for making life easier

### Watch Bezel Fitting Die Set



Bezel Fitting Die Set - for Rolex & Tudor Watches

- Set of 7 Aluminium Dies with Nylon Inner Ring
- Dies interchangeable with Bergeon crystal presses 5500A & 5500C
- Supplied with 2 adaptors

Code	Description	UOM	Price
B30545	Bezel Fitting Die Set for Rolex & Tudor Watches	PACK*7	£33.50

## Watch Bezel Re-Sizing Tool, A\*F Swiss



A\*F Swiss - Watch Bezel Re-Sizing Tool

Similar to the Rolex 1006 tool, but covers more sizes

This tool is designed for adjusting the size of watch bezels and retaining rings by reducing and enlarging as required.

- Suitable for all bezels
- Particularly suited to Rolex bezels, including the GMT-Masters, Submariners & the large DateJust II model
- The parts are accurately machined from high quality steel
- Finely finished to avoid any damage to the bezel
- The handle is marked with coloured guide marks to judge the degree of resizing
- Supplied in plastic carry case with foam inserts
- A\*F Swiss

Set includes:

- 1 End-piece for holding reduction chucks
- 3 Stepped reduction chucks, maximum capacities of each: Ø46, 44 & 42mm
- 1 End-piece for holding enlarging chucks
- 2 Stepped enlarging chucks, maximum capacities of each: Ø43 & 45mm
- 1 Stand for the assembled tool
- 1 Plastic carrying case

Code	Description	UOM	Price
R47011	Bezel Re-Sizing Tool	EACH	£995.00

## Watch Bezel Remover, A\*F Swiss



Watch Bezel Remover

In hard rubber, for removing rotating watch bezels. Held in the hand to twist and pull off the bezel. Avoids damage to the bezel.

- For bezel diameters 38 to 45mm
- Simple, easy and quick
- Swiss made

Code	Description	UOM	Price
R31399	Watch Bezel Remover, A&F Swiss	EACH	£16.95

## Watch Bezel Remover, Bergeon 6820

Bezel Remover - Bergeon 6820

Tool for the safe removal of tight rotating watch bezels, diver type on high grade watches (Rolex, Tags, etc.).

Tool provided with 3 adjustable clamping jaws (height 3.5 mm) of hardened and tempered steel, suitable for bezels ranging in Ø from 27 mm to 45 mm.

Automatic jaws locking, position-indexing by spring balls. Bezel clamping by disengageable knurled button.

Supplied with :

- 2 bevelled extraction stakes, Ø 17 and 22 mm
- 2 mm Allen key.

Code	Description	UOM	Price
B0086	Watch Bezel Remover, Bergeon 6820	EACH	£279.95
B6676	Watch Bezel Remover Jaw, Bergeon 6820M	EACH	£34.50
B0086A	Watch Bezel Remover Center Stake, Ø22mm	EACH	£17.75



## Watch Bezel Remover, Bergeon 7820.10



Bezel Remover - Bergeon 7820.10

A new ergonomic concept, allowing the extraction of every kind of bezel, from Ø20 to Ø58mm, with great ease. This device offers the possibility of integrating various chucks and tightening jaws, adapted to the majority of bezel shapes.

- Handle made of anodized aluminium.
- Universal chuck in synthetic material with diameter markings
- One set of four movable metal jaws which screw in, giving maximum stability
- Three different diameter centre dies: Ø10, Ø15, Ø20mm

Support Stand:

- Bergeon 7820.0001 (B33547)
- Brings a better stability during operation of extraction

Code	Description	UOM	Price
B33547	Watch Bezel Remover, Bergeon 7820.10	EACH	£595.00
B35494	Watch Bezel Remover Support Stand	EACH	£260.00

## Watch Bezel Remover, Horotec Swiss



Bezel Remover - Horotec Swiss

Tool for the safe removal of tight rotating watch bezels, diver type on and for Rolex generics and other generic brands.

- Horotec 07.117
- 4 tempered & polished stainless steel blades
- Precise finish and alignment
- Spare blade available
- Size: 150 x 60 x 65mm
- Weight 880g

Code	Description	UOM	Price
B44237	Bezel Removing Tool, Horotec Swiss	EACH	£210.00
B44245	Blade for Bezel Tool, Horotec Swiss	EACH	£22.95

## Watch Bezel Remover (Including Rolex Generics)

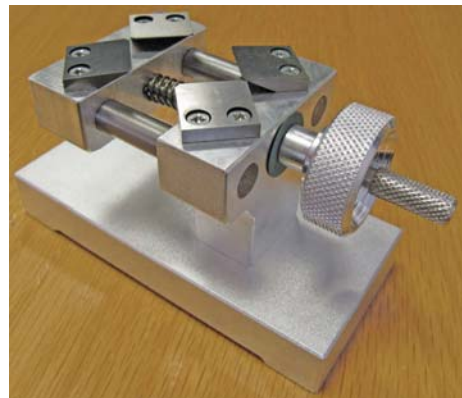

Bezel Remover - Rolex Generics

Tool for the safe removal of tight rotating watch bezels, diver type on and for Rolex generics and other generic brands.

- Size: 130 x 60 x 70mm
- Weight 1500g

Code	Description	UOM	Price
R19381	Bezel Remover for Rolex Generics	EACH	£125.00
R19381J	Bezel Remover Jaw for Rolex Generics	EACH	£10.75

## Watch Bezel & Case Back Remover, Horotec



Horotec Swiss - up to Ø45mm

- Can remove bezels and case backs up to Ø45mm
- Tool to open snap on watch case backs or to remove turning bezels
- Can be screwed securely to your work bench (screws not supplied)
- Swiss made
- Horotec MSA 07.115

1. The watch is placed upside down on the height's adjustable green rubber sprung loaded support mount.
2. The action can be made by 2 blades placed opposite to each other or by one blade and the white delrin die placed to opposite.
3. The white delrin die has a hole Ø10mm to place the watch crown inside, holding the case steady

Supplied with:

- 2 blades, width 2mm
- 2 blades, width 4mm
- 1 case supporting delrin die
- Pin holder
- Assortment of 11 pins: Ø0.40, 0.60, 0.70, 0.80, 0.90, 1.00, 1.10, 1.20, 1.40, 1.50 & 2.00mm
- Pin to remove blades

Interchangeable Spare Parts:

- C31508 (07.115-A): one blade only width 2mm
- C31509 (07.115-B): one blade only width 4mm
- C31510 (07.115-C): delrin die
- C31511 (07.115-D): pin for removing blades

Code	Description	UOM	Price
C31480	Bezel Removing & Case Opening Tool, Horotec	EACH	£181.95
C31508	2mm Blade, Horotec	EACH	£16.95
C31509	4mm Blade, Horotec	EACH	£16.95
C31510	Delrin Die, Horotec	EACH	£11.95
C31511	Pin for Removing Blades, Horotec	EACH	£1.50

Price breaks available, see website

### Watch Bezel & Case Back Remover, Horotec Extra Large

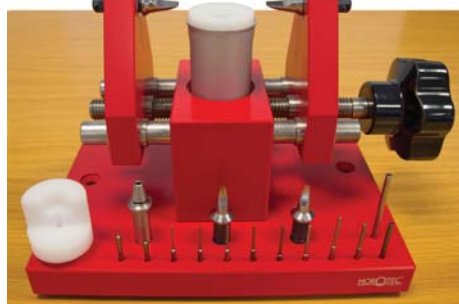

Horotec Swiss - Extra Large - up to Ø60mm

- Can remove bezels and case backs up to Ø60mm
- Tool to open snap on watch case backs or to remove turning bezels
- Equipped with a screw to stabilise the table at the desired height
- Can be screwed securely to your work bench (screws not supplied)
- Has 4 ridged rubber feet for stability
- Swiss made
- Horotec MSA 07.119

1. The watch is placed upside down on the height's adjustable green rubber sprung loaded support mount.
2. The action can be made by 2 blades placed opposite to each other or by one blade and the white delrin die placed to opposite.
3. The white delrin die has a hole Ø10mm to place the watch crown inside, holding the case steady

Supplied with:

- 2 blades, width 2mm
- 2 blades, width 4mm
- 1 case supporting delrin die
- Pin holder
- Assortment of 11 pins: Ø0.40, 0.60, 0.70, 0.80, 0.90, 1.00, 1.10, 1.20, 1.40, 1.50 & 2.00mm
- Pin to remove blades

Interchangeable Spare Parts:

- C31508 (07.115-A): one blade only width 2mm
- C31509 (07.115-B): one blade only width 4mm
- C31510 (07.115-C): delrin die
- C31511 (07.115-D): pin for removing blades

Code	Description	UOM	Price
C45771	Bezel Removing & Case Opening Tool, Extra Large	EACH	£295.00



## WATCH BRACELET ADJUSTING

### BRACELET ADJUSTING PIN TOOLS

Bracelet adjusting pin tools are the most basic of tools any workshop or counter top service should have and one of the most essential. We have a large range and several types of pin removing tools available.

- Straightforward and easy to use, simply choose the correct size pin for your watch bracelet pins and either lightly hammer out, push out or gently screw the pusher pin in to push the bracelet pin out.
- These tools are used for the most common type of bracelet pin you will encounter
- If using free pins, it is best to use a bracelet holding block, see our "bracelet holding blocks" section for a full range

#### Base, Block & Pins, Bergeon 7744



- Tool to drive out bracelet pins complete with accessories
- With enough space to enable the ejection of the pins
- Ergonomic, professional style

Contents:

- 2 x bracelet holders (B0153)
- Wooden base (B8580)
- 1 pin holder (B0163)
- 6 pins: Ø0.40, 0.60, 0.80, 1.00, 1.50 & 2.00mm (replacements available see code B6686)

Code	Description	UOM	Price
B42020	Bracelet Adjusting Tool, Bergeon 7744	EACH	£54.95

#### Base, Block & Pins, Cousins Swiss Style



Bracelet Pin Remover - Base, Blocks & Pins - Cousins Swiss Style

- Link pin remover set
- Comprehensive selection of sizes
- Presented and stored on a wooden base
- Stainless steel
- 6 different size pins included

Set includes:

- Pin removing punch
- 6 pins: Ø0.60mm x 2, Ø0.80mm x 2 & Ø1.00mm x 2
- Bracelet holding block x 2

• Wooden base

Code	Description	UOM	Price
B39646	Base, Blocks & Pins Set	EACH	£7.95

#### Individual, Heavy Duty



Bracelet Pin Removers - Push In

- Push in pin remover
- Excellent for removing rusted or stuck pins
- Length of the removing pin can be set using the guide and stop
- Two different height bracelet tables for different bracelet thicknesses
- Plastic body
- Supplied with 2 pins, Ø1.20 & Ø1.40mm
- 190 x 25 x 30mm (L x W x H)

Code	Description	UOM	Price
B47704	Bracelet Pin Remover, Heavy Duty	EACH	£6.95
B47705	Ø1.20mm Pin	EACH	£0.75
B47733	Ø1.40mm Pin	EACH	£0.75

#### Individual, Heavy Duty, Adjustable



Bracelet Pin Removers - Individual - Heavy Duty - Adjustable

- Shorten the pin, giving it extra strength
- Great for those stubborn bracelet pins
- Ø0.70, 0.80 & 0.90mm available
- Adjust the pin length from 1 to 18mm
- Tool diameter Ø10mm
- Knurled handles
- Spare pins available
- Stainless steel

Code	Description	UOM	Price
B40370	Ø0.70mm Bracelet Pin Tool	EACH	£6.95
B40371	Ø0.70mm Spare Pin	EACH	£0.95
B40372	Ø0.80mm Bracelet Pin Tool	EACH	£6.95
B40373	Ø0.80mm Spare Pin	EACH	£0.95
B40374	Ø0.90mm Bracelet Pin Tool	EACH	£6.95
B40375	Ø0.90mm Spare Pin	EACH	£0.95

#### Micro Choc, Swiss Style



Bracelet Pin Remover - Micro Choc - Swiss Style

- Supplied with 3 different pulsing force springs
- In Plastic Wallet

• Pin Ø0.80mm

Code	Description	UOM	Price
C30546	Micro Choc Watch Bracelet Pin Remover	EACH	£6.50
C30546A	Pin for Micro Choc	EACH	£1.10

## Parallel Action, Bergeon 6578



Bergeon 6578 - Swiss Made

- One side to drive pins in and out
- One side to drive out spring bars
- Metal frame with plastic handles
- Replacement pins/bits available

Code	Description	UOM	Price
B0149	Bracelet Adjusting Tool, Bergeon 6578	EACH	£59.95
B0158	Ø0.70mm Pin	EACH	£3.25
B0159	Ø0.80mm Pin	EACH	£3.25
B0160	Ø0.90mm Pin	EACH	£3.25
B0161	Ø1.20mm Pin	EACH	£3.25
B0161A	Gooved Stake	EACH	£1.75

## Punch Kit in Wooden Box



Bracelet Pin Remover - 10 Pins

- Link pin remover set
- Comprehensive selection of sizes
- Presented and stored in a wooden box
- Stainless Steel
- 10 different size pins included (and available separately)

Pin sizes:

- Ø0.40mm, Ø0.60mm, Ø0.70mm, Ø0.80mm
- Ø0.90mm, Ø1.00mm, Ø1.10mm, Ø1.20mm
- Ø1.50mm, Ø2.00mm

Code	Description	UOM	Price
B38403	Bracelet Removing Set	PACK*11	£7.95
B38404	Bracelet Pin Holder	EACH	£0.95
B38405	Ø0.40mm Bracelet Pin	EACH	£0.75
B38406	Ø0.60mm Bracelet Pin	EACH	£0.75
B38407	Ø0.70mm Bracelet Pin	EACH	£0.75
B38408	Ø0.80mm Bracelet Pin	EACH	£0.75
B38409	Ø0.90mm Bracelet Pin	EACH	£0.75
B38410	Ø1.00mm Bracelet Pin	EACH	£0.75
B38411	Ø1.10mm Bracelet Pin	EACH	£0.75
B38412	Ø1.20mm Bracelet Pin	EACH	£0.75
B38413	Ø1.50mm Bracelet Pin	EACH	£0.75
B38414	Ø2.00mm Bracelet Pin	EACH	£0.75

## Punch Kit, Swiss Style



Bracelet Pin Remover - 6 Pins - Swiss Style

- Swiss style link pin remover
- Aluminium
- Supplied with 6 pins: Ø0.40, 0.60, 0.80, 1.00, 1.50 & 2.00mm
- Pins also available separately, our reference P37851

Code	Description	UOM	Price
L37834	Bracelet Pin Remover	EACH	£3.95
P37851	Bracelet Pin Remover Pins	PACK*6	£2.25

## Punch Kit, Swiss Style & Block

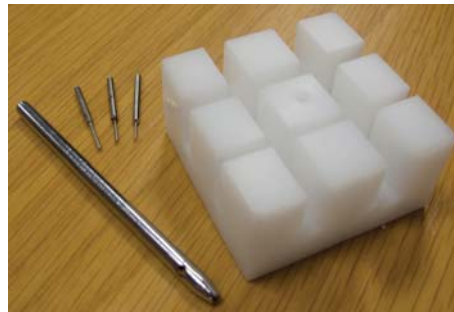

Bracelet Pin Remover - With Block

- High quality bracelet holder made from DELRIN with slots 3, 5, 6 and 8mm
- Link remover (set of 3): Ø0.60, 0.80 & 1.00mm
- Weight: 90g

Code	Description	UOM	Price
B31272	Bracelet Pin Remover with Delrin Bracelet Holder	EACH	£8.95

## Punch Set, A\*F Swiss

A\*F Swiss

Set of 3 in plastic box. Overall length 55mm with handles in chromed brass, diameter 5mm. Tips in hardened steel, working length 15mm. Easily replaced by means of a fixing screw.



- Set of 3: Ø0.70, 0.80 & 1.00mm
- Knurled handles
- Spare pins & grub screws available
- Overall length 55mm

Code	Description	UOM	Price
B0144	Bracelet Pin Remover Set	PACK*3	£8.85
B6683	Ø0.70mm Bracelet Pin Remover	EACH	£3.25
B6684	Ø0.80mm Bracelet Pin Remover	EACH	£3.25
B6685	Ø1.00mm Bracelet Pin Remover	EACH	£3.25
B0155	Ø0.70mm Spare Pins	PACK*10	£4.50
B0156	Ø0.80mm Spare Pins	PACK*10	£4.50
B0157	Ø1.00mm Spare Pins	PACK*10	£4.50
B40537	Ø0.70mm Grub Screw	PACK*10	£2.95

## Bracelet Adjusting Kit

See Page 1104



## Punch Set, Cousins Swiss Style

Bracelet Pin Removers

- Set of 3: Ø0.70, 0.80 & 1.00mm
- Knurled handles
- Stainless steel
- Spare pins available
- Made in India



Code	Description	UOM	Price
B32813	Bracelet Pin Remover Set	PACK*3	£4.65
B32814	Ø0.70mm Spare Pins	PACK*10	£2.95
B32815	Ø0.80mm Spare Pins	PACK*10	£2.95
B32816	Ø1.00mm Spare Pins	PACK*10	£2.95
B40264	Grub Screws for Pin Removers	PACK*10	£0.95

## Screw In, A\*F Swiss



Bracelet Pin Removers - Screw In - A\*F Swiss

- A\*F Swiss
- In black plastic
- Supplied with spacer for use with three thicknesses of bracelets
- Replaceable pin driver in hardened steel

Code	Description	UOM	Price
B0143	Bracelet Screw In Pin Remover	EACH	£7.95
B0143A	Pin for Bracelet Screw In Pin Remover	EACH	£1.95

## Screw In, Bergeon 7230



Bracelet Pin Removers - Screw In

- Bergeon Swiss
- Ø0.80mm pin
- Supplied with spacer for use with three thicknesses of bracelets

Code	Description	UOM	Price
B47040	Bracelet Pin Remover, Bergeon 7230	EACH	£9.75

<b>B47041</b>	Bracelet Pin, Bergeon 7230-G08	EACH	<b>£1.50</b>
Price breaks available, see website			

**Screw In, Extra Wide**



Bracelet Pin Removers - Screw In - Extra Wide

- Durable body and pin holder made in steel
- Easy change watch pin chuck holder
- Includes 4 pin sizes: Ø0.60, 0.90, 1.00 and 1.10mm
- Bracelet height adjustment feature
- Can accommodate bracelets up to 40mm in width

Code	Description	UOM	Price
<b>C36096</b>	Bracelet Screw in Pin Remover, Extra Wide	EACH	<b>£6.95</b>
<b>C36093</b>	Extra Pins for Link remover	PACK*3	<b>£2.95</b>

**Screw In, Heavy Duty**



Bracelet Pin Removers - Screw In

- Durable body and pin holder made in steel
- Easy change screw in pins
- Includes 2 pins, sizes: Ø0.80 & 1.00mm
- Can accommodate bracelets up to 24mm in width

Code	Description	UOM	Price
<b>B37242</b>	Bracelet Screw in Pin Remover	EACH	<b>£3.50</b>
<b>B37762</b>	Pins for Link Remover	PACK*2	<b>£1.95</b>

**Screw In, Seiko Style**



Bracelet Pin Removers - Screw In

- Plastic, lightweight body
- Ø0.80mm pin
- With slanted removable base for different thickness bracelets
- Easy change screw in pins
- Large easy to use handle
- Excellent value

Code	Description	UOM	Price
<b>B47060</b>	Bracelet Pin Remover	EACH	<b>£2.25</b>
<b>B47061</b>	Ø0.80mm Pin	EACH	<b>£0.50</b>



**BRACELET ADJUSTING PIN TOOLS WITH STAND**

These are the original Swiss made Bergeon & Horotec tools along with good value Swiss style alternatives bought to you by Cousins. Take a look at the various versions, all designed to remove watch bracelet pins and links, and choose one you are most comfortable with.

- When used correctly, there is pretty much zero chance of scratching a watch bracelet with these precision made tools
- Highest grade steel is used achieving ultimate quality and high precision tools

**Bergeon 7745 (reduced set)**



Press to drive bracelet pins in and out of watch bracelets.

Reduced version of 7745.100 (B38740).

- Contents:
- 1 Stand
  - 1 bracelet holding block (B0153)
  - 1 pin holder (B0163)
  - 1 set of 6 pins on wooden stand: Ø0.40, 0.60, 0.80, 1.00, 1.50 & 2.00mm (replacements available see code B6686)

Code	Description	UOM	Price
<b>B38739</b>	Bracelet Adjusting Tool, Bergeon 7745	EACH	<b>£149.95</b>

**Bergeon 7745.100**



To drive pins in and out and remove screwed links.

- The bracelet block allows accurate positioning for watches with leather or metal bracelets.
- The two bases are height adjustable to align the job in exactly the right place

- Contents:
- 1 Stand
  - 1 pin holder with drum (B0163A)
  - 2 bases with adjustable heights (B8682 & B8683)
  - 1 bracelet holder (B0153)

- 1 set of ten blades on wooden stand (B6682B)
- 1 set of 6 pins on wooden stand: Ø0.40, 0.60, 0.80, 1.00, 1.50 & 2.00mm (replacements available see code B6686)
- 1 mirror disc

Code	Description	UOM	Price
<b>B38740</b>	Bracelet Adjusting Tool, Bergeon 7745-100	EACH	<b>£184.95</b>

**Bergeon 8745, Ergonomic**



Press to drive bracelet pins in and out of watch bracelets. & unscrew and screw watch bracelets.

Ergonomic design and sleek black look.

- Contents:
- 1 Support
  - 1 Pin holder with drum (B0163A)
  - 2 Bases with adjustable heights (B8682 & B8683)
  - 1 Set of 10 blades (B6682B)
  - 1 Set of 6 pins: Ø0.40, 0.60, 0.80, 1.00, 1.50 & 2.00mm (replacements available see code B6686)
  - Pins, blades & bases all handily stored in base of tool
  - Bracelet block code B0153 (not included)

Code	Description	UOM	Price
<b>B38741</b>	Bracelet Adjusting Tool, Bergeon 8745	EACH	<b>£118.75</b>

**Bergeon 7745.ASS, Accessories**



Code	Description	UOM	Price
<b>B0152</b>	Accessory Set Complete, Bergeon 7745.ASS	EACH	<b>£64.95</b>
<b>B42021</b>	Base, Bergeon 7744-S	EACH	<b>£16.95</b>
<b>B8682</b>	Base Ø20mm, Bergeon 6745-SR20	EACH	<b>£11.75</b>
<b>B8683</b>	Base Ø28mm, Bergeon 6745-SR28	EACH	<b>£12.75</b>
<b>B6687</b>	Blade Ø0.80mm Straight, Bergeon 6745-MC	EACH	<b>£2.50</b>
<b>B6687A</b>	Blade Ø1.00mm Straight, Bergeon 6745-MC	EACH	<b>£2.50</b>
<b>B6687B</b>	Blade Ø1.20mm Straight, Bergeon 6745-MC	EACH	<b>£2.50</b>
<b>B6682</b>	Blade Ø1.50mm Cross head, Bergeon 6745-MC	EACH	<b>£2.50</b>
<b>B6688C</b>	Blade Ø1.50mm Straight, Bergeon 6745-MC	EACH	<b>£2.50</b>
<b>B6682A</b>	Blade Ø2.00mm Cross head, Bergeon 6745-MC	EACH	<b>£2.50</b>
<b>B6688D</b>	Blade Ø2.00mm Straight, Bergeon 6745-MC	EACH	<b>£2.50</b>
<b>B6682B</b>	Blade Set, Bergeon 7745-MS	EACH	<b>£27.65</b>
<b>B8663</b>	Cracked Base Chuck, Bergeon 6745-DF	EACH	<b>£6.25</b>
<b>B47706</b>	Mirror Disc, Bergeon 7745-P	EACH	<b>£18.95</b>

B6686	Pin Ø0.40mm, Bergeon 6745-G	EACH	£1.25
B2060	Pin Ø0.60mm, Bergeon 6745-G	EACH	£1.25
B32752	Pin Ø0.70mm, Bergeon 6745-G	EACH	£1.25
B2061	Pin Ø0.80mm, Bergeon 6745-G	EACH	£1.25
B32753	Pin Ø0.90mm, Bergeon 6745-G	EACH	£1.25
B2062	Pin Ø1.00mm, Bergeon 6745-G	EACH	£1.25
B2063	Pin Ø1.50mm, Bergeon 6745-G	EACH	£1.25
B2064	Pin Ø2.00mm, Bergeon 6745-G	EACH	£1.25
B0162	Pin Holder, Bergeon 6744-PG	EACH	£11.85
B0163	Pin Holder, Bergeon 6745-PG	EACH	£9.95
B0163A	Pin Holder With Drum, Bergeon 6745-PG-A	EACH	£16.50

## Cousins, Swiss Style



### Bracelet pin and screw removing kit

Kit contains:

- 12 pins, two each of: Ø0.40, 0.60, 0.80, 1.00, 1.50 & 2.00mm
- Pin holder with knurled handle
- Two screwdriver blades: Ø1.50 & 2.50mm
- Screwdriver blade holder with knurled handle
- Screw holding base with Ø2.50mm blade
- Bracelet holding block
- 90 x 60 x 80mm (H x W x D)
- Made in far east

What amazing value!

Code	Description	UOM	Price
B39645	Bracelet Pin Tool Kit	EACH	£17.95
B41167	Blade Set with Stand	PACK*10	£4.95
B41168	Pin Set with Stand	PACK*6	£4.95

### Protection Film for Watch Bracelets



See Page 1192

### Watchmakers Hammers



See Page 911

## Horotec Swiss 10.499 (reduced set)



### Horotec Swiss 10.499 (reduced set) - Bracelet Pin Adjusting Tool

Press for rapidly assembling and disassembling bracelet pins. All accessories easily accessible and stored on the top plate. The vertical guide allows perfect alignment with the bracelet pins.

Kit contains:

- 1 Press
- 6 pins: Ø0.40, 0.60, 0.80, 1.00, 1.50 & 2.00mm, stored on top plate
- Pin holder
- Bracelet holding block
- Horotec 10.499

For spare pins and accessories see code B41129

Code	Description	UOM	Price
B41128	Bracelet Pin Tool Kit, Horotec Swiss	EACH	£63.95

## Horotec Swiss 10.500



### Horotec Swiss 10.500 - Bracelet Pin Adjusting Tool

Press for rapidly assembling and disassembling bracelet pins and screws. All accessories easily accessible and stored on the top plate. The vertical guide allows perfect alignment with the bracelet screws & pins.

Kit contains:

- 1 Press
- 11 pins: Ø0.40, 0.60, 0.70, 0.80, 0.90, 1.00, 1.10, 1.20, 1.40, 1.50 & 2.00mm, stored on top plate
- 12 blades, 2 each of sizes: Ø0.80, 1.00, 1.20, 1.40, 1.60 & 2.00mm
- Pin holder
- Knurled handle for blades
- Bracelet holding block & support
- Counter screw blade holder
- Delrin conical bracelet protection
- Horotec 10.500

Code	Description	UOM	Price
B43274	Bracelet Pin Tool Kit, Horotec Swiss	EACH	£119.95
B43276	Conical Delrin Bracelet Protection	EACH	£9.95
B43278	Counter Screw Blade Holder	EACH	£29.95
B43277	Knurled Handle	EACH	£25.95
B43275	Pin Holder	EACH	£16.75
B41129	Ø0.40mm Pin	EACH	£1.05
B41130	Ø0.60mm Pin	EACH	£1.05
B41131	Ø0.80mm Pin	EACH	£1.05
B41132	Ø1.00mm Pin	EACH	£1.05
B41133	Ø1.50mm Pin	EACH	£1.05
B41134	Ø2.00mm Pin	EACH	£1.05

Price breaks available, see website

## BRACELET ADJUSTING PLIERS

Excellent range of pliers specifically for the quick adjustment of your customers' watch bracelets.

- Adjust your watch band and avoid damage with these watch link removing pliers
- These unique devices are perfect for removing stubborn watch bracelet pins
- Remove slide type links with ease with our specially manufactured "pull out" link pliers
- Our spring loaded multi pin tools are designed so that the "punch pin" will move perfectly parallel, ensuring a damageless removal of the pin if used properly

### Link Removing Pliers

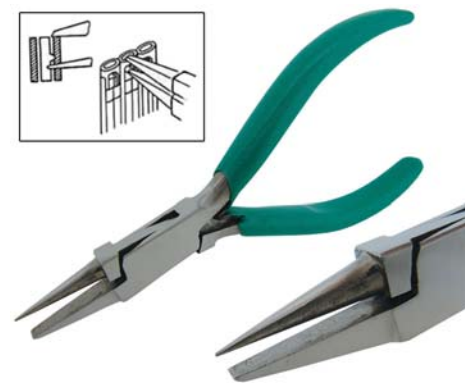
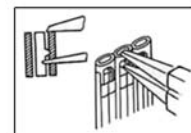

### Bracelet Link Removing Pliers

- An essential tool for adjusting the length of metal watch bracelets
- Lap joint with one flat and one extended round jaw

Code	Description	UOM	Price
B35025	Bracelet Link Removing Pliers	EACH	£3.95

Pliers  
All Types  
See Page 941

**Link Removing Pliers, A\*F Swiss**



Bracelet Link Removing Pliers - A\*F Swiss

- An essential tool for adjusting the length of metal watch bracelets
- In polished steel, lap joint with one flat and one extended round jaw
- A top quality version of this popular tool
- Handles covered in blue plastic with leaf springs

Code	Description	UOM	Price
B0145	Bracelet Link Removing Pliers	EACH	£16.50

**Pin Removing Pliers, Bergeon**



Bracelet Pin Removing Pliers - Multi Pin - Bergeon Swiss

This sturdy plier is an effective tool used for inserting, removing and reinserting pins for all types of metal bands / watch bracelets. Its plastic support prevents damage to the band during handling.

Using the set of shims provided as standard accessories, you can adjust the pliers to the size of the band. The integral protective supports and the shims position the job correctly and the tool has an overall feel of renowned Bergeon quality.

- Up to 24mm Width
- Rapid and easy removal of pinned watch bracelet links
- Ø0.75 & 0.85mm pin plungers
- Includes full and illustrated instructions
- Bergeon 6819

Code	Description	UOM	Price
B9239	Pin Removing Pliers, Bergeon	EACH	£155.00
B9239A	Ø0.75mm Pin	EACH	£11.75
B9239B	Ø0.85mm Pin	EACH	£11.75
B9239C	Ø0.75mm Pin, Spring & Body	EACH	£16.85
B9239D	Ø0.85mm Pin, Spring & Body	EACH	£16.85



**Brass Jaw Pliers to prevent scratching**



See Page 947

**Bracelet Adjusting Kit**



See Page 1104

**Pin Removing Pliers, Cousins**



Bracelet Pin Removing Pliers - Multi Pin - Cousins

- Up to 24mm Width
- Rapid and easy removal of pinned watch bracelet links
- Supplied with pouch and 0.80 & 1.00mm pin pusher
- Spare pins, Cousins Item: B12166, B12167 & B8786

Code	Description	UOM	Price
B8785	Pin Removing Pliers, Cousins	EACH	£11.50
B12166	Ø0.70mm Replacement Pin	EACH	£1.45
B12167	Ø0.80mm Replacement Pin	EACH	£1.45
B8786	Ø1.00mm Replacement Pin	EACH	£1.45

**Pin Removing Pliers, Cousins, Adjustable Height**



Bracelet Pin Removing Pliers - Multi Pin - Adjustable Height

This is a high quality manufacture plier with the unique feature of an adjustable height platform, making it easier than ever to position the pin perfectly, reducing the risk and the effort of bracelet pin removal considerably.

- For bracelets up to 30mm
- Unique height adjustable platform, capable of raising the resting bracelet up to 2.5mm
- Includes Ø0.80mm pins x 2

Code	Description	UOM	Price
B37849	Pin Removing Pliers, Cousins, Adjustable Height	EACH	£99.95
B37858	Ø0.80mm Pin	EACH	£7.95



**Pin Removing Pliers, Cousins, Wide Bracelets**



Bracelet Pin Removing Pliers - Multi Pin - Cousins - Extra Wide

- Up to 40mm Width
- Rapid and easy removal of pinned links from larger watch bracelets
- Supplied with pouch and 0.80 & 1.00mm pin pusher
- Spare pins, Cousins Item: B12166, B12167 & B8786

Code	Description	UOM	Price
B20208	Pin Removing Pliers, Cousins, Wide Bracelets	EACH	£11.95

**BRACELET ADJUSTING SCREW REMOVERS**

Our popular range of tools for removing and fitting screw type case bars and watch bracelet links.

Also available a new tools from A\*F Switzerland, perfect for removing bracelet screws from Gucci and other high end fashion watches

**Screw Holding Bases**

Bracelet Screw Holding Bases

Save time with these handy tools which simplify the removal and fitting of metal watch bracelet links, screw type case bars or any general watch screws.

- Used to remove double-ended screws from a watch bracelet
- Just fit the bottom screw slot over the right blade ensuring an easy unscrewing from the top
- Makes life simple and assures that the bracelet will not be damaged, if used properly

**A\*F Swiss, Screw Holding Base**

A\*F Swiss 189.895

- Save time with this handy tool which simplifies removal and fitting of metal watch bracelet links and screw type case bars
- Features three replaceable, popular size blades Ø1.00,





# WATCH BRACELET ADJUSTING

1.40, 3.00mm mounted on a non-slip, aluminium stand

Replacement Blade item codes:

- Ø1.00mm = S2941
- Ø1.40mm = S2943
- Ø3.00mm = S2947

Code	Description	UOM	Price
B0146	A*F Swiss, Screw Holding Base	EACH	£17.50

## Bergeon Swiss, Screw Holding Base



Bergeon 6730

- In brass, base Ø70mm
- 4 screwdriver blades Ø1.00, 1.40, 1.80 and 3.00mm
- Working blade with adjustable height
- Removable rubber protection on top
- Very stable

Code	Description	UOM	Price
B0147	Bergeon Swiss, Screw Holding Base	EACH	£83.95

## Indian, Screw Holding Base

- Three blades (Ø1.00, 1.40, 2.50mm) are immovably fitted to a solid aluminium block
- Used to remove double-ended screws from a watch bracelet

- Just fit the bottom screw slot over the right blade ensuring an easy unscrewing from the top
- Makes life simple and assures that the bracelet will not be damaged, if used properly

Code	Description	UOM	Price
S36098	Indian, Screw Holding Base	EACH	£4.50

## Screw Removing Tool for Gucci



A\*F Swiss

A new tool, Swiss made, perfect for removing bracelet screws from Gucci and other high fashion watches.

- Body made from hard black plastic
- Blades recessed in nylon to avoid scratching
- Plastic collars can be filed as required

- Supplied with two spare blades
- Spare compartment to store spare blades and parts
- Ø3mm blade
- Can also be used for case screws

Code	Description	UOM	Price
B40266	Bracelet Screw Removing Tool	EACH	£47.95
B40267	Blade for Bracelet Screw Removing Tool	EACH	£5.95

## BRACELET BLOCKS

*Large range of watch band holders available including plastic, flexi-plastic and wooden; we have a large range of holders that will not damage your bracelets.*

- The bracelets are held in the slots of the holding block, rendering it easy to use a pin punch and hammer to remove band links and pins when sizing a watch bracelet
- Watch bracelet holders are made of a strong and rigid synthetic material that will not mar or scratch watch bands
- Our bracelet screw holding bases are designed perfectly for removing the double ended screw bracelet pin type

### Holding Vice

## 8 x 14mm Capacity Bracelet Holder, A\*F Swiss

- A\*F Swiss
- Ideal for after-sales service
- Hard plastic vice which does not damage soft metals such as gold
- Can hold any type of bracelet



Code	Description	UOM	Price
B12394	8 x 14mm Capacity Bracelet Holder, A*F Swiss	EACH	£23.95

## 9.5 x 12mm Capacity Bracelet Holder, Horotec Swiss

- Max bracelet thickness 9.5mm
- Bracelet holding height 12mm
- 55 x 35 x 22mm
- Horotec 10.513



Code	Description	UOM	Price
B44243	9.5 x 12mm Capacity Bracelet Holder, Horotec Swiss	EACH	£15.95

## 10 x 10mm Capacity Bracelet Holder

- Max bracelet thickness 10mm
- Bracelet holding height 10mm
- 37 x 34 x 31mm
- White plastic



Code	Description	UOM	Price
B37143	10 x 10mm Capacity Bracelet Holder	EACH	£5.50

## 10 x 49mm Capacity Bracelet Holder, Horotec Swiss

- Max bracelet thickness 10mm
- Bracelet holding height 49mm
- 55 x 35 x 22mm
- Horotec 10.519



Code	Description	UOM	Price
B44244	10 x 49mm Capacity Bracelet Holder, Horotec Swiss	EACH	£22.95

## 15 x 12mm Capacity Bracelet Holder

- Max bracelet thickness 15mm
- Bracelet holding height 12mm
- 55 x 35 x 20mm
- Black plastic



Code	Description	UOM	Price
B38765	15 x 12mm Capacity Bracelet Holder	EACH	£6.95

## 24 x 17mm Capacity Bracelet Holder

- Max bracelet thickness 17mm
- Bracelet holding height 24mm
- 50 x 40 x 40mm
- Black plastic



Code	Description	UOM	Price
B38766	24 x 17mm Capacity Bracelet Holder	EACH	£8.95

### Holding Blocks

## Standard Slots (with 4 Pin Holders)

- Non Swiss
- Size: 50 x 50mm



Code	Description	UOM	Price
B36097	Standard Slots (with 4 Pin Holders)	EACH	£1.95

## Standard Slots, Wooden

- Non Swiss
- Size: 60 x 60mm



Code	Description	UOM	Price
B36466	Standard Slots, Wooden	EACH	£1.95

## Standard & Wide Slots

- Non Swiss
- Size: 50 x 50mm



Code	Description	UOM	Price
B36468	Standard & Wide Slots	EACH	£1.25

**PRICE PROMISE  
GUARANTEE**



**Standard & Wide Slots (with 4 Pin Holders)**



Features holes on sides for holding pin punches.  
 • Non Swiss  
 • Size: 65 x 65 x 25mm  
 • Standard & wide slots  
 • Plastic

Code	Description	UOM	Price
B44368	Standard & Wide Slots (with 4 Pin Holders)	EACH	£1.95

**Standard & Wide Slots XL, Plastic**



• With slots 3 to 10mm wide  
 • Extra large base catering for extra long bracelets  
 • 80 x 80 x 30mm

Code	Description	UOM	Price
B45546	Standard & Wide Slots XL, Plastic	EACH	£2.25

**Standard & Wide Slots, XL - Wooden**



• With slots 3 to 7mm wide  
 • Extra large base catering for extra long bracelets  
 • 80 x 80 x 30mm

Code	Description	UOM	Price
B43267	Standard & Wide Slots, XL - Wooden	EACH	£3.50

**Holding Blocks, Swiss**

**A\*F Swiss, Ø50mm**



• Swiss Made  
 • Round base  
 • Ø50mm  
 • Mixture of standard & wide slots  
 • A\*F Swiss

Code	Description	UOM	Price
B40265	A*F Swiss, Ø50mm	EACH	£21.95

**A\*F Swiss, 50 x 50mm**



A\*F Swiss  
 Model in hard black plastic with wider slots for larger bracelets. Cut-out in one corner for watch case horns.

• Swiss Made  
 • Size: 50 x 50 x 30mm  
 • Standard slots

Code	Description	UOM	Price
B0154	A*F Swiss, 50 x 50mm	EACH	£13.65

**A\*F Swiss, 55 x 55mm**



A\*F Swiss  
 Best quality model in hard black plastic with various widths of slots.  
 • Swiss Made  
 • Size: 50 x 50 x 40 mm  
 • Wide slots for thicker bracelets

Code	Description	UOM	Price
B4193	A*F Swiss, 55 x 55mm	EACH	£9.95

**Bergeon 6744P, 53 x 53mm**



• Swiss Made  
 • Bergeon 6744.P  
 • Sizes: 53 x 53 x26mm  
 • Slots Sizes: 2.2, 2.6, 3.0, 3.4, 3.8 & 4.0mm

Code	Description	UOM	Price
B0153	Bergeon 6744P, 53 x 53mm	EACH	£5.85

**Bergeon 6744.P.S, 53 x 53mm (Soft Flexi Base)**



• Swiss Made  
 • Bergeon 6744.P.S  
 • In "soft" synthetic material  
 • Sizes: 53 x 53 x26mm  
 • Slots Sizes: 2.2, 2.6, 3.0, 3.4, 3.8 & 4.0mm

Code	Description	UOM	Price
B15209	Bergeon 6744.P.S, 53 x 53mm (Soft Flexi Base)	EACH	£7.75

**Bergeon 6744.P1 53 x 53mm**



Wide slots for thicker bracelets  
 • Swiss Made  
 • Bergeon 6744.P  
 • Sizes: 53 x 53 x26mm  
 • Slots Sizes: 3.5, 4.0, 4.5, 5.0, 5.5, 6.0, 6.5 & 7.0mm

Code	Description	UOM	Price
B8593	Bergeon 6744.P1 53 x 53mm	EACH	£7.95

**Bergeon 6744.P1.S, 53 x 53mm (Soft Flexi Base)**



Wide slots for thicker bracelets  
 • Swiss Made  
 • Bergeon 6744.P1.S  
 • In "soft" synthetic material  
 • Especially made for all precious metals, without any risk of scratching  
 • Sizes: 53 x 53 x26mm  
 • Slots Sizes: 3.5, 4.0, 4.5, 5.0, 5.5, 6.0, 6.5 & 7.0mm

Code	Description	UOM	Price
B18337	Bergeon 6744.P1.S, 53 x 53mm (Soft Flexi Base)	EACH	£9.25

**Horotec Swiss, 52 x 52mm Universal**



• Horotec Swiss Made  
 • Mixture of standard & wide slots  
 • Size: 52 x 52 x 25mm  
 • Slot Sizes: 2.8 to 6.3mm

Code	Description	UOM	Price
B4710	Horotec Swiss, 52 x 52mm Universal	EACH	£4.45

**BRACELET CLASP SAVER TOOL**

**Bracelet Clasp Saver Tool**



A\*F 189.835 - Swiss Made

Watchmakers adjustment tool for folding clasps on watch bracelets. No more need to throw away or replace folding or butterfly clasps that no longer lock with this clasp saving tool!

- Saves folding clasps by allowing them to "click" and lock again
- Clasps which were previously impossible to fix or repair can now be saved
- Prevents expensive bracelet purchases
- Works by carefully & precisely adjusting the thick metal middle sections found on most folding clasps
- Instructions included
- Swiss made

Die dimensions;

- Push Dies = widest working width
- U Dies = outside width

Code	Description	UOM	Price
B38846	Bracelet Clasp Saver, A*F 189.835	EACH	£109.95
C48011	Push Die (8mm) Curve	EACH	£9.95
C48012	Push Die (8mm) Point	EACH	£9.95
C48013	Push Die (18mm) Curve	EACH	£9.95
C48014	U Die (14mm)	EACH	£9.95
C48015	U Die (20mm)	EACH	£9.95
C48016	U Die (22mm)	EACH	£9.95

**Bracelet Clasps  
 All Types  
 See Page 618**

**Watch Bracelet Pins, Tubes & Bars  
 See Page 624**

## BRACELET CUTTING, FILING & SHORTENING

- Most popular tooling for adjusting a watch bracelet quickly and efficiently
- This Bergeon Swiss traditional bracelet cutting machine is one of the highest end units available for precision cutting and sizing of your watch bracelets
- Traditional filing blocks are also available

### Bracelet Cutting Machine

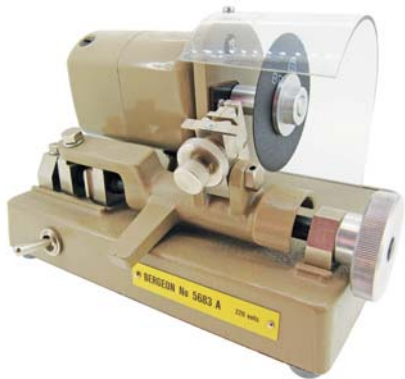

- Bergeon 5683
- The cutting length is regulated by a pair of mobile stops
- Cutting is effected within a few seconds automatically on the left and right, to the corresponding dimensions
- Switch for starting
- Dimensions: 180 x 125 x 125 mm
- Max. cutting width 30 mm
- Wheel Ø 65 mm
- Instructions included

Code	Description	UOM	Price
B0142	Bracelet Cutting Machine, Bergeon 5683	EACH	£725.00
B0140	Cutting Wheel, Bergeon 5544-C	EACH	£5.50
B22683	Motor, Bergeon 5683-MA-220	EACH	£950.00

### Bracelet Filing Blocks

- Held in vice.
- Ensures a quick and easy method of filing the ends of bracelets for the band that requires a small adjustment to be made.
- Will take most sizes of bracelets (12 grooves).



Code	Description	UOM	Price
B7989	Bracelet Filing Block, Cousins	EACH	£3.50
B0141	Bracelet Filing Block, Bergeon Swiss	EACH	£29.95

### Rowi Bracelet Shortening Tool



For Rowi Fixoflex watch bracelets, easily lift end tabs & remove "U" shape pins with ease.

- Ideal for removing Rowi Fixoflex expanding bracelet links

• Length 85mm

Code	Description	UOM	Price
RW350060	Rowi Bracelet Shortening Tool	EACH	£4.50

## WATCH CASE & WATCH GLASS TOOLS

Watch Case Back Removing:

More and more watches these days come with a screw on case back. These feature small depressions spaced around the edge of the case back, designed to provide a gripping point for the use of a wrench case opener. Knowing how to use one of these screw type case openers properly will prevent you from damaging the watch.

How to use:

1. Place the wrist watch face down in a protective watch holder.
2. Having picked the correct shaped tool bits (by matching them to the indentations on the case) or die for the case you are about to work on, insert them firmly into the screwback tool.
3. Adjust the width of the bits on the tool to match the size of the screw down case back on the watch.
4. Matching up the tool bits and the indentations on the case back, apply firm downward pressure, hold the watch or watch holder and turn the wrench to loosen the back. If using a benchtop tool the same principle applies.

## CASE OPENING - BAUME & MERCIER

BAUME & MERCIER  
MAISON D'HORLOGERIE GENEVE 1830

Universal Fitting Dies for Tools:

- Bergeon Swiss
- Horotec Swiss
- Swiss Style

Fitting:

- Universal = dies fit directly on to the tools
- Universal with Adapter = dies fit on to the tools using adaptor C0318

### Baume & Mercier Dies, Horotec, Universal

Universal Fitting Dies for Tools:

- Bergeon Swiss
- Horotec Swiss
- Swiss Style

Fitting:

- Universal = dies fit directly on to the tools

Dimensions are the outside edge of the teeth diameter.

Code	Description	UOM	Price
C30934	Ø25mm (B&M), Horotec, Universal	EACH	£37.50
C30935	Ø30mm (B&M), Horotec, Universal	EACH	£37.50
C30936	Ø30mm (B&M), Horotec, Universal	EACH	£37.50

### Baume & Mercier Dies with Holder, A\*F Swiss



A\*F Swiss - Case Back Opening Tools

A\*F 167.781 (C9577) is supplied with a Die Holder & 3 dies (Ø21, 26 & 29mm) for Baume & Mercier case backs. The dies will also fit any of our universal case back tools listed below. Dimensions are the outside edge of the teeth diameter.

Universal Fitting Dies for Tools:

- Bergeon Swiss
- Horotec Swiss
- Swiss Style

Fitting:

- Universal = dies fit directly on to the tools

Code	Description	UOM	Price
C9577	A*F 167.781 Baume & Mercier Opening Tool	EACH	£184.75

### Baume & Mercier Dies with Holder, Non Swiss

VALUE



- Three different diameter dies, inside diameters: Ø21, 26 & 29mm
- Die holder
- Specifically for Baume & Mercier watches

Supplied with a Die Holder & 3 dies (Ø21, 26 & 29mm) for Baume & Mercier case backs. These dies will only specifically fit the tool handle supplied in this set. Dimensions are the outside edge of the teeth diameter.

Code	Description	UOM	Price
B37141	Baume and Mercier Opener	EACH	£19.95

## Case Back Gaskets



See Page: 371

## CASE OPENING - BREITLING

Universal Fitting Dies for Tools:

- Bergeon Swiss
- Horotec Swiss
- Swiss Style

Fitting:

- Universal = dies fit directly on to the tools
- Universal with Adapter = dies fit on to the tools using adaptor C0318

### Breitling Dies, A\*F Swiss, Universal



A\*F Swiss - 18 piece Set

Universal Fitting Dies for Tools:

- Bergeon Swiss
- Horotec Swiss
- Swiss Style

Fitting: Universal with Adapter = dies fit on to the tools using adaptor C0318 or C39846. Superb quality, exact sizes to avoid damaging case backs.

Die diameters, all with 15 edges unless stated:

- Ø19.00mm (No.1) - 13 edges
- Ø23.50mm (No.2) - 13 edges
- Ø26.00mm (No.3) - 13 edges
- Ø26.50mm (No.4) - 13 edges
- Ø26.70mm (No.7)
- Ø29.60mm (No.8)
- Ø30.60mm (No.5) - 14 edges
- Ø31.10mm (No.9)
- Ø33.50mm (No.10)
- Ø33.90mm (No.11)
- Ø34.40mm (No.12)
- Ø36.00mm (No.13)
- Ø36.80mm (No.6) - 14 edges
- Ø37.00mm (No.14)
- Ø37.90mm (No.15)
- Ø38.20mm (No.16)
- Ø43.30mm (No.17)
- Ø44.10mm (No.18)

Code	Description	UOM	Price
D38827	Breitling Die Set, A*F Swiss	PACK*18	£785.00

# Breitling Generic Glasses

See Page 142

### Breitling Dies, Cousins, Universal



Elegant "Black" Presentation Wooden Case - 15 piece Set & Individuals

Universal Fitting Dies for Tools:

- Bergeon Swiss
- Horotec Swiss
- Swiss Style

Fitting: Universal with Adapter = dies fit on to the tools using adaptor C0318 or C39846

Die diameters with 15 edges (unless stated):

- Ø19.00mm (No.1)
- Ø19.00mm (No.16) - 13 edges\*
- Ø23.50mm (No.2)
- Ø23.80mm (No.17) - 13 edges\*
- Ø26.00mm (No.3)
- Ø26.20mm (No.18) - 13 edges\*
- Ø26.50mm (No.4)
- Ø26.80mm (No.5)
- Ø26.80mm (No.19) - 13 edges\*
- Ø29.50mm (No.6)
- Ø30.40mm (No.20) - 14 edges\*
- Ø33.50mm (No.7)
- Ø34.50mm (No.8)
- Ø36.00mm (No.9) - 14 edges
- Ø36.00mm (No.10) - 15 edges
- Ø37.00mm (No.11)
- Ø38.20mm (No.12)
- Ø38.50mm (No.13)
- Ø42.50mm (No.14)
- Ø44.00mm (No.15)

\* dies are not included in the set

Size: 300 x 250 x 40mm

Weight: 1.7kg

Code	Description	UOM	Price
C33486	Die Set for Breitling	PACK*15	£295.00
C33959	Ø19.00mm (No.1) Die	EACH	£10.95
C40376	Ø19.00mm (No.16) Die - 13 Edges*	EACH	£19.95
C33960	Ø23.50mm (No.2) Die	EACH	£10.95
C40377	Ø23.80mm (No.17) Die - 13 Edges*	EACH	£19.95
C33961	Ø26.00mm (No.3) Die	EACH	£19.95
C40378	Ø26.20mm (No.18) Die - 13 Edges*	EACH	£21.95
C33962	Ø26.50mm (No.4) Die	EACH	£19.95
C33963	Ø26.80mm (No.5) Die	EACH	£19.95
C40379	Ø26.80mm (No.19) Die - 13 Edges*	EACH	£21.95
C33964	Ø29.50mm (No.6) Die	EACH	£19.95
C40380	Ø30.40mm (No.20) Die - 14 Edges*	EACH	£27.95
C33965	Ø33.50mm (No.7) Die	EACH	£21.95
C33966	Ø34.50mm (No.8) Die	EACH	£21.95
C33967	Ø36.00mm (No.9) Die - 14 Edges	EACH	£21.95
C33968	Ø36.00mm (No.10) Die	EACH	£21.95
C33969	Ø37.00mm (No.11) Die	EACH	£21.95
C33970	Ø38.20mm (No.12) Die	EACH	£21.95
C33971	Ø38.50mm (No.13) Die	EACH	£21.95
C33972	Ø42.50mm (No.14) Die	EACH	£24.65
C33973	Ø44.00mm (No.15) Die	EACH	£21.95

### Breitling Dies, Horotec, Universal



Universal Fitting Dies for Tools:

- Bergeon Swiss
- Horotec Swiss
- Swiss Style

Fitting:

- Universal = dies fit directly on to the tools



Code	Description	UOM	Price
C32440	Ø35mm (Breitling) Horotec, Universal	EACH	£42.95
C32441	Ø36mm (Breitling) Horotec, Universal	EACH	£42.95
C22164	Ø37mm (Breitling) Horotec, Universal	EACH	£42.95
C32442	Ø38mm (Breitling) Horotec, Universal	EACH	£42.95

## CASE OPENING - CITIZEN

Universal Fitting Dies for Tools:

- Bergeon Swiss
- Horotec Swiss
- Swiss Style

Fitting:

- Universal = dies fit directly on to the tools

### Citizen Dies, Horotec, Universal



Universal Fitting Dies for Tools:

- Bergeon Swiss
- Horotec Swiss
- Swiss Style

Fitting:

- Universal = dies fit directly on to the tools



Code	Description	UOM	Price
C22163	Horotec, Citizen Ø35mm Aqualand Die	EACH	£44.95

## Citizen Capacitors



See Page: 157

## Citizen Watch Bracelets & Straps

See Page 158

**CASE OPENING - GUCCI**

**Gucci Style Case Openers**

Small tool designed specially to open Gucci-type case backs with notches. Swiss & Non Swiss made.

- Open Gucci case backs in a snap!
- With this specially designed Gucci watch opener, you simply insert the hook into the notch on the watch case back and pop it off.
- A real time saver!

**Gucci Style**



Have you ever been presented with a Gucci watch to repair, only to realize it will take hours of struggling to get it open? No longer.

- Open Gucci case backs in a snap!
- With this specially designed Gucci watch opener, you simply insert the hook into the notch on the watch case back and pop it off.
- A real time saver!

Size: 100 x 10 x 6mm

Code	Description	UOM	Price
C36095	Gucci Style	EACH	£1.95

**Gucci Style, A\*F Swiss**



A\*F 167.448 - Swiss Made

Small tool designed specially to open Gucci-type case backs with notches. Swiss made.

- Open Gucci case backs in a snap!
- With this specially designed Gucci watch opener, you simply insert the hook into the notch on the watch case back and pop it off.
- A real time saver!
- Length 130mm

Code	Description	UOM	Price
C48017	Gucci Style, A*F Swiss	EACH	£10.95

New Jaxa Watch Case Opener specifically designed to include the opening of large watches

- The ergonomic shape provides a firm and comfortable grip
- Opens diameters from Ø18mm to Ø62mm
- Supplied with 4 sets bits (3 each shape)
- Supplied in box
- Bergeon 2819.08

Code	Description	UOM	Price
C32160	Jaxa, Bergeon 2819.08	EACH	£129.95
C0329	Flat (A) Tool Bit, Bergeon 2819.A	EACH	£2.65
C0330	Notch (B) Tool Bit, Bergeon 2819.B	EACH	£2.65
C0331	Round Hole (C) Tool Bit, Bergeon 2819.C	EACH	£2.65
C0332	Oyster (D) Tool Bit, Bergeon 2819.D	EACH	£2.65

**LG Master Wrench, U.S.A**



Case Back Tool - LG Master Wrench - Made in U.S.A

A finely made case opener in steel with black finish. Knurled handle for maximum grip. Opens all types and sizes of cases with backs either knurled, polygonal, notched or with holes. Triple locking system adapts to backs with odd or even number of holes. The case back can be held in the opener after removal. Supplied with 4 sets of 3 interchangeable pins for all types of cases.

- Opens cases up to Ø43mm
- Knurled handle for maximum grip
- Opens all types and sizes of cases with backs either knurled, polygonal, notched or with holes
- Triple locking system adapts to backs with odd or even number of holes
- The case back can be held in the opener after removal
- Supplied complete with 4 sets of 3 interchangeable pins for all types of cases
- Made in U.S.A

Code	Description	UOM	Price
C0334	Jaxa Style LG Master Wrench, USA	EACH	£59.95
C0334A	Bit "1" (Pin), for LG Master Wrench	PACK*3	£4.95
C0334B	Bit "2" (Flat), for LG Master Wrench	PACK*3	£4.95
C0334C	Bit "3" (Notch), for LG Master Wrench	PACK*3	£4.95
C0334D	Bit "4" (Oyster), for LG Master Wrench	PACK*3	£5.15

**Single Handed (Regular)**

**VALUE**



Jaxa Style Case Back Opener

- Universal key for opening and closing screw back watch cases.
- All steel body with aluminum handle.
- Supplied with 4 sets of pins in a wooden case
- Opens case backs up to Ø39mm

Replacement Tool Bits C0333A

Code	Description	UOM	Price
C0333	Single Handle (Regular)	EACH	£5.95
C0333A	Tool Bits for Single Handed (Regular)	PACK*12	£2.30

**Single Handed (up to Ø60mm)**

**VALUE**



Jaxa Style Case Opener including Large Diameters - Single Handed

- Modified to open case backs of larger watches
- Opens diameters from 19mm to 60mm
- Packed in a light weight cardboard box
- 4 (x3) Different Sets of Bits
- Replacement bits C0333A

Code	Description	UOM	Price
C31300	Single Handle (up to Ø60mm)	EACH	£12.95

**Single Handed (up to Ø60mm), Light Weight**

**VALUE**



Jaxa Style Case Opener including Large Diameters - Light Weight

- Modified to open case backs of larger watches
- Opens diameters from 18mm to 62mm
- Packed in a light weight cardboard box
- 4 (x3) Different Sets of Bits

Code	Description	UOM	Price
C35123	Single Handed (up to Ø60mm), Light Weight	EACH	£19.95
C47759	Tool Bits for Single Handed (Lightweight)	PACK*12	£7.95

**Double Handed (up to Ø60mm)**

**VALUE**



Jaxa Style Case Opener, Double Handed with Large Diameters

- For big size cases
- From Ø18 to 62mm watch case
- 4 (x4) different key tips

Code	Description	UOM	Price
C35303	Double Handed (up to Ø60mm)	EACH	£22.95

**CASE OPENING - JAXA & JAXA STYLE**

**Bergeon Swiss, Jaxa**



Case Back Tool - Bergeon Swiss

**CASE OPENING - OMEGA**

Universal Fitting Dies for Tools:

- Bergeon Swiss
- Horotec Swiss
- Swiss Style

Fitting:

- Universal = dies fit directly on to the tools
- Universal with Adaptor = dies fit on to the tools using adaptor C0318

**Omega Dies, Horotec, Universal**

Universal Fitting Dies for Tools:

- Bergeon Swiss
- Horotec Swiss
- Swiss Style

Fitting:

- Universal = dies fit directly on to the tools



Code	Description	UOM	Price
M19220	Ø20mm (Omega Seamaster) Horotec, Universal	EACH	£24.95
M19221	Ø30mm (Omega Seamaster) Horotec, Universal	EACH	£24.95
M31381	Ø33mm (Omega Seamaster) Horotec, Universal	EACH	£28.75
M31382	Ø42mm (Omega Seamaster) Horotec, Universal	EACH	£26.95

**Omega Dies, Seamaster, Universal**



Universal Fitting Dies for Tools:

- Bergeon Swiss
- Horotec Swiss
- Swiss Style

Fitting: Universal = dies fit directly on to the tools

Universal Omega Seamaster

- 4 pieces
- 5 Pin Steel Dies
- Die Ø20, 30, 33 & 42mm
- Weight 230g

Code	Description	UOM	Price
C33482	Omega Dies, Seamaster, Universal	PACK*4	£46.50

**Omega Genuine & Generic Parts**

**See Page 173**

**Omega Specific Tools**

**See Page 1105**

**Omega Dies, Seamaster, Universal with Adaptor**



Universal Fitting Dies for Tools:

- Bergeon Swiss
- Horotec Swiss
- Swiss Style

Fitting: Universal with Adaptor = dies fit on to the tools using adaptor C0318 or C39846

- 4 pieces
- 5 Pin Steel Dies
- Die Ø20, 30, 33 & 42mm
- Weight 280g

Code	Description	UOM	Price
C33483	Omega Seamaster Die Set for Bergeon	PACK*4	£49.95

**Omega Dies with Holder, Horotec**



Horotec Swiss 07.304

Supplied with a Die Holder & 2 metal dies (5 pins) Ø20 & 30mm for Omega Seamaster ladies & Gents case backs. The dies will also fit any of our universal case back tools listed below.

Universal Fitting Dies for Tools:

- Bergeon Swiss
- Horotec Swiss
- Swiss Style

Fitting:

- Universal = dies fit directly on to the tools listed above

Code	Description	UOM	Price
M19219	Universal Die Holder, Horotec (plus 2 Omega dies)	EACH	£69.95

**PRICE PROMISE GUARANTEE**



**CASE OPENING - PANERAI**

**Individual Dies, Panerai**

Universal Fitting Dies for Tools:

- Bergeon Swiss
- Horotec Swiss
- Swiss Style

Fitting:

- Universal = dies fit directly on to the tools



Code	Description	UOM	Price
C22166	Ø30mm (Panerai) Horotec, Universal	EACH	£49.95
C22167	Ø35mm (Panerai) Horotec, Universal	EACH	£49.95
C22168	Ø39mm (Panerai) Horotec, Universal	EACH	£49.95
C22169	Ø42mm (Panerai) Horotec, Universal	EACH	£49.95

**Set of Dies, Panerai (Hand Held)**



- Set of 4
- Hand Held
- Metal Dies

Code	Description	UOM	Price
D32767	Panerai Die Set	PACK*4	£59.95

**CASE OPENING - ROLEX**

**Rolex Dies, Horotec**

Horotec Swiss

Dimensions are the outside edge of the teeth diameter.

Universal Fitting Dies for Tools:

- Bergeon Swiss
- Horotec Swiss
- Swiss Style

Fitting:

- Universal = dies fit directly on to the tools



Code	Description	UOM	Price
R32676	Ø18.5mm (Rolex) Horotec, Universal	EACH	£20.95
R32677	Ø20.2mm (Rolex) Horotec, Universal	EACH	£18.95
R32678	Ø22.5mm (Rolex) Horotec, Universal	EACH	£18.95
R32679	Ø26.5mm (Rolex) Horotec, Universal	EACH	£18.95
R32680	Ø28.3mm (Rolex) Horotec, Universal	EACH	£18.95
R32681	Ø29.5mm (Rolex) Horotec, Universal	EACH	£18.95

**Rolex Dies with Adaptor, Bergeon**



Bergeon Swiss

Bergeon 5538 set of 6 milled dies (Ø18.5, 20.2, 22.5, 26.5, 28.3, 29.5mm) and adaptor 5538T for Rolex Oyster watch cases. These dies will also fit any of our universal case back tools listed below using adaptor C0318 (included). Dimensions are the outside edge of the teeth diameter.

Universal Fitting Dies for Tools:

- Bergeon Swiss
- Horotec Swiss
- Swiss Style

Fitting: Universal with Adapter = dies fit on to the tools listed above using adaptor C0318 (included)

Code	Description	UOM	Price
C0318A	Rolex Oyster Adaptor and Dies, Bergeon 5538	EACH	£149.50

**Rolex Dies with Rounded Grooves, Bergeon**



Bergeon Swiss

Bergeon 7001.B set of 4 specially milled dies with rounded grooves (Ø18.5, 24.4, 29.6, 32mm) for new style Rolex watch case backs. Available in a set or individually these dies will also directly fit any of our universal case back tools listed below. Dimensions are the outside edge of the teeth diameter.

Universal Fitting Dies for Tools:

- Bergeon Swiss
- Horotec Swiss
- Swiss Style

Fitting:

• Universal = dies fit directly on to the tools

Code	Description	UOM	Price
C47035	Rolex Oyster (Round Grooved Cases) Die Set	PACK*4	£175.00
C47036	Ø18.5mm (Rolex) Bergeon, Universal	EACH	£54.95
C47037	Ø24.4mm (Rolex) Bergeon, Universal	EACH	£54.95
C47038	Ø29.6mm (Rolex) Bergeon, Universal	EACH	£54.95
C47039	Ø32mm (Rolex) Bergeon, Universal	EACH	£54.95

**Rolex Dies with Wrench, Bergeon**



Bergeon Swiss

Bergeon 5537 set of 6 milled dies (Ø18.5, 20.2, 22.5, 26.5, 28.3, 29.5mm) and wrench for Rolex Oyster watch cases. These dies will also fit any of our universal case back tools listed below using adaptor C0318 or C39846.

Universal Fitting Dies for Tools:

- Bergeon Swiss
- Horotec Swiss
- Swiss Style

Fitting: Universal with Adapter = dies fit on to the tools listed above using adaptor C0318 or C39846

Code	Description	UOM	Price
C0314	Rolex Oyster Case Opener, Bergeon 5537	EACH	£118.95

**Rolex Dies with Wrench, Non Swiss**



Set of 6 milled dies (Ø18.5, 20.2, 22.5, 26.5, 28.3, 29.5mm) and wrench for Rolex Oyster watch cases. These dies will also fit any of our universal case back tools listed below using adaptor C0318. Dimensions are the outside edge of the teeth diameter.

Universal Fitting Dies for Tools:

- Bergeon Swiss
- Horotec Swiss
- Swiss Style

Fitting: Universal with Adapter = dies fit on to the tools listed above using adaptor C0318 or C39846

Code	Description	UOM	Price
C35042	Rolex Oyster Case Opener	EACH	£18.95

**Rolex Generic Parts**  
See Page 187

**Rolex Dies with Wrench Plus, Non Swiss**



**Individuals**

Excellent high quality, Swiss style case back tool for Rolex Oyster & Rolex Deep Sea Dweller.

Set of 7 milled dies, 6 most popular (Ø18.5, 20.2, 22.5, 26.5, 28.3, 29.5mm) plus also the "Deep Sea Dweller" die Ø36.5mm. Included also is a stainless steel wrench for Rolex Oyster watch cases and an adaptor die to enable the dies to be fitted to any of our universal case back tools listed below. Dimensions are the outside edge of the teeth diameter.

Universal Fitting Dies for Tools:

- Bergeon Swiss
- Horotec Swiss
- Swiss Style

Fitting: Universal with Adapter\* = dies fit on to the tools listed above using adaptor supplied (included)

Code	Description	UOM	Price
C39845	Set of Dies, Rolex (with Wrench, Plus) Non Swiss	EACH	£79.95
C39848	Wrench for Case Back Opener Dies	EACH	£15.95
C39846	Rolex Die Adapter	EACH	£19.95
C39849	Ø18.50mm (Rolex) Universal*	EACH	£9.95
C39850	Ø20.20mm (Rolex) Universal*	EACH	£9.95
C39851	Ø22.50mm (Rolex) Universal*	EACH	£9.95
C39852	Ø26.50mm (Rolex) Universal*	EACH	£9.95
C39853	Ø28.30mm (Rolex) Universal*	EACH	£9.95
C39854	Ø29.50mm (Rolex) Universal*	EACH	£9.95
C39847	Ø36.50mm (Rolex) Universal*, Deep Sea Dweller	EACH	£19.95

**Rolex Dies with Holder, Sea Dweller**



- Ridged, plastic handle for extra grip, Ø70mm
- Overall length 70mm

Excellent hand held tool for opening case backs. Includes case back die for the Rolex Sea Dweller (Die Ø36.50mm). Easy to use with one hand. The die supplied will also fit any of our universal case back tools listed below using adaptor C0318 or C39846. Dimensions are the outside edge of the teeth diameter.

Universal Fitting Dies for Tools:

- Bergeon Swiss
- Horotec Swiss
- Swiss Style

**TODAY** SAME DAY DISPATCH

Fitting: Universal with Adapter = dies fit on to the tools listed above using adaptor C0318 or C39846

Code	Description	UOM	Price
C39292	Rolex Sea Dweller Holder & Die	EACH	£24.95

**Rolex Dies with Holder, LG Openall, U.S.A**



Case Back Tool - LG Openall Rolex - Made in U.S.A

A compact case opener of robust construction with cast aluminium frame finished in blue/grey enamel. Designed to be held in the bench vice or the screw to the bench base. Specially suitable for effortless opening of all Rolex style watch cases. Supplied with 6 tempered knurled dies which interlock perfectly with the case back.

The central threaded shaft, fitted with the appropriate die is screwed down on the watch. The integral spring ensures a firm uniform pressure. Nothing can slip, slide or jump. The torsion bar is then used to provide enough leverage to open the most stubborn case back. The built-in adjustable case holder grips all sizes of watches.

- Designed to be held in a bench vice
- Specially suitable for effortless opening of all Rolex style watch cases
- Supplied with 6 tempered knurled dies
- Diameters: Ø18.00, 20.00, 22.50, 26.50, 23.80, 29.50mm (dimensions are the outside edge of the teeth diameter)
- Weight: 590g
- Made in USA

Use in conjunction with the LG master wrench (C0344) to open case backs other than Rolex. Simply insert the pin supplied into the shaft of the Openall which will then fit to the wrench. The wrench can then be held firmly and snugly in place in slots in case backs by screwing the Openall down.

Code	Description	UOM	Price
C0315	Rolex LG Openall, U.S.A	EACH	£69.95
C20987	Ø18mm Oyster Die	EACH	£5.95
C20986	Ø20mm Oyster Die	EACH	£5.95
C0315A	Ø22.5mm Oyster Die	EACH	£5.95
C7052	Ø26mm Oyster Die	EACH	£5.95
C7053	Ø28mm Oyster Die	EACH	£5.95
C7844	Ø29mm Oyster Die	EACH	£5.95

Die Adapter, Far East



See Page 1064

**CASE OPENING - SNAP-ON BACKS**



Opening a watch case is a fundamental skill that anyone dealing in watches, be it repairs and services or simple battery changes, needs to have. However, by not using the right tools and techniques, it is easy to damage a watch case, which would obviously make your customers' very unhappy.

Opening your watch case can be easy, all you need is a watch case opener and case holder. Here is our large selection and variety of press fit, snap on watch case back type openers. You will surely be able to find one to suit you and your methods of working.

How to use:

1. Turn the watch case over in your hands so the glass is facing down, or if appropriate depending on the watch style, place in a case holder.
2. Find the slot or opening groove around the edge of case back for the placement of the case opener. (Run the edge of a fingernail around the full circumference of the case back to feel for the grooves as they may not be easily seen).
3. Place the blade of the case opener into the slot or groove that you have located on the watch back.
4. Pry up on the case back with the blade of the case opener until the back pops off.
5. Do not use excessive force either when lifting the case back off or pressing it back on, this may cause damage to the case or even the movement inside.
6. Make sure the seal (gasket) is in good condition (if it has one) before you replace the case back. This will better protect your watch against water intrusion than trying to press it back on as tightly as you can get it.

**Bench Top Case Openers**

Case Back Opening Tools - Snap On Watch Case Backs

For easy removal of the tightest of snap on case backs. Accurate positioning of the case opening blade coupled with a steady smooth screw in action of the blade provides successful case opening every time.

- Professional Choice
- No Risk of Injury
- Controlled & Safe
- Suitable for Semi Skilled Personnel

www. Online Discounts

**A\*F Swiss Watch Holding Case Opener**



A\*F Swiss

- Reinforces the professional watchmaker's hands and opens the watch more reliably than a hand held blade
- Cover and case are protected, so the opening of the case can also be carried out by semi-skilled personnel
- Perfect for battery exchange service
- No risk of injury
- Plastic body

Code	Description	UOM	Price
C9865	A*F Swiss Watch Holding Case Opener	EACH	£54.95

**A\*F Swiss Blade**

- For Tool reference C9865



Code	Description	UOM	Price
C9865A	A*F Swiss Blade	EACH	£6.75

**Chinese Watch Holding Case Opener**



Chinese - Superior Quality Version

Reinforces the professional watchmaker's hands and opens the watch more reliably than a hand held blade. Cover and case are not damaged, so the opening of the case can also be carried out by semi-skilled personnel.

- Open cases up to Ø55mm
- Perfect for battery exchange service
- No risk of injury
- Spare blade available (reference C40364)
- Overall size 160 x 65 x 50mm
- 450g

Code	Description	UOM	Price
C40363	Chinese Watch Holding Case Opener	EACH	£64.95

**Chinese Blade**

- For Tool reference C40363



Code	Description	UOM	Price
C40364	Chinese Blade	EACH	£6.50

Case Back & Bezel Remover



See Page 1053



## Greiner Timoknack Watch Holding Case Opener

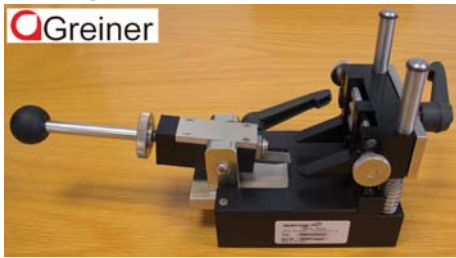

The most advanced and professional watch case snap on back opener on the market. The Greiner Timoknack can open all watch cases with push on/snap on case backs. Its ergonomic & specialised design makes it great for any especially tough job or for continuous use in the busy workshop. The expert construction design attaches great importance to opening of the case backs without damaging the case.

- Rubber pad for the watch case to rest on
- Half round recesses for the crown
- Case is then secured with 2 movable supporting jaws
- Super controlled blade movement with an extended screw in motion
- Swiss made
- Greiner 38000

See PDF for full details

Code	Description	UOM	Price
C47917	Greiner Timoknack Watch Holding Case Opener	EACH	£425.00

## Greiner Timoknack Blade



- Spare blade for Greiner case back opener "Timoknack" (C47917)

Code	Description	UOM	Price
C47918	Greiner Timoknack Blade	EACH	£26.95

## Indian Watch Holding Case Opener



Indian - Economy Version

Reinforces the professional watchmaker's hands and opens the watch more reliably than a hand held blade. Cover and case are not damaged, so the opening of the case can also be carried out by semi-skilled personnel.

- Perfect for battery exchange service
- No risk of injury
- Supplied with spare blade
- Max case opening width Ø39mm

Code	Description	UOM	Price
C19024	Indian Watch Holding Case Opener	EACH	£14.50

## Indian Blade

- For Tool reference C19024



Code	Description	UOM	Price
C31544	Indian Blade	EACH	£1.50

## Case Knives

Snap On Watch Case Backs - Hand Held

A selection of the most popular hand held "Knife Style" snap on watch case back opening tools.

- Bergeon
- Wenger
- Chinese
- Indian
- Extra long (XL)
- Curved blade
- Metal, plastic or PVC grips

## Fixed Blade, Bergeon 4932



Bergeon Swiss professional watchmakers case knife. Precisely beveled blade made by the famous "Swiss Army" knife manufacturer Wenger.

- Watch case opener with metal handle
- Stainless steel blade
- Length 110mm
- Bergeon Swiss
- Bergeon 4932

Code	Description	UOM	Price
C0339	Fixed Blade, Bergeon 4932	EACH	£16.50

## Fixed Blade, Dumont (Horotec 07.008)



- Dumont Swiss (Horotec 07.008)
- Ideal for both left and right handed user
- For snap on watch case backs

Code	Description	UOM	Price
C12496	Fixed Blade, Dumont (Horotec 07.008)	EACH	£29.95

## Fixed Blade, Metal Handle



- Single blade case opener
- Metal handle
- Overall length 115mm
- Handle length 85mm
- Made in China

Code	Description	UOM	Price
C37431	Fixed Blade, Metal Handle	EACH	£6.75

## Fixed Blade, Metal Handle, Curved Blade



- Single blade case opener
- Curved blade
- Metal handle
- Overall length 130mm
- Handle length 95mm
- Blade length 20mm
- Blade width 9mm
- Inexpensive to replace if lost

- Made in India

Code	Description	UOM	Price
K39640	Fixed Blade, Metal Handle, Curved Blade	EACH	£1.50

## Fixed Blade, Metal Handle XL



- Single blade case opener
- Extra long (XL)
- Metal handle
- Overall length 160mm
- Handle length 115mm
- Blade length 50mm
- Blade width 9mm
- Inexpensive to replace if lost
- Made in India

Code	Description	UOM	Price
K39638	Fixed Blade, Metal Handle XL	EACH	£2.95

## Fixed Blade, Plastic Handle



- Single blade case opener
- Plastic handle
- Overall length 115mm
- Handle length 85mm
- Inexpensive to replace if lost
- Made in India

Code	Description	UOM	Price
K39635	Fixed Blade, Plastic Handle	EACH	£1.95

## Fixed Blade, PVC Handle



- Single blade case opener
- PVC coated handle
- Overall length 115mm
- Handle length 90mm
- Inexpensive to replace if lost
- Made in India

Code	Description	UOM	Price
K39634	Fixed Blade, PVC Handle	EACH	£0.95

## Fixed Blade, PVC Handle, Broad Blade



- Single blade case opener
- PVC coated handle
- Overall length 130mm
- Handle length 100mm
- Blade length 33mm
- Blade width 15mm
- Inexpensive to replace if lost
- Made in India

Code	Description	UOM	Price
K39639	Fixed Blade, PVC Handle, Broad Blade	EACH	£1.50

**Fixed Blade, Wooden Handle**



- Single blade case opener
- Wooden, riveted handle
- Overall length 130mm
- Handle length 100mm
- Blade length 37mm
- Blade width 15mm
- Inexpensive to replace if lost
- Made in India

Code	Description	UOM	Price
K39636	Fixed Blade, Wooden Handle	EACH	£2.50

**Twin Blade, Bergeon Swiss**



Bergeon Swiss professional watchmakers case opener and knife combined. Precisely beveled blade made by the famous "Swiss Army" knife manufacturer Wenger.

- Watch case opener & knife
- Thicker, chunkier handle for better grip
- Stainless steel, closable blades
- Length when closed 75mm
- Includes tweezers and oil pick
- Bergeon Swiss
- Bergeon 7403

Code	Description	UOM	Price
C48332	Twin Blade, Bergeon Swiss	EACH	£19.95

**Twin Blade, Chinese**



- Double blade case opener
- Stainless steel blades
- Metallic blue handle
- Overall length 170mm
- Handle length 85mm
- Made in China

Code	Description	UOM	Price
C37430	Twin Blade, Chinese	EACH	£6.50

**Twin Blade, Victorinox Swiss**



- New style Cousins Swiss case knife
- Thicker, chunky handle for better grip
- Swiss Made
- Cousins twin bladed case opener
- Combined 2 stainless steel blades
- Includes Swiss army style tweezers
- Includes toothpick
- Closed length 85mm

Code	Description	UOM	Price
K0890	Twin Blade, Victorinox Swiss	EACH	£13.75

**Case Knives (Big Handles)**

Big Handle - Snap On watch Case Backs

- Big handle
- More power during operation
- Plastic or metal handles
- Bergeon, Horotec or Chinese

**Bergeon Swiss, Metal Handle (Left Handed)**



- Big handle Ø22mm
- Anodised aluminium handle
- Stainless steel blade
- Left handed
- More power during operation
- Lightweight
- Snap on case back opener
- Bergeon 6987G

Code	Description	UOM	Price
C40302	Bergeon Swiss, Metal Handle (Left Handed)	EACH	£37.95

**Bergeon Swiss, Metal Handle (Right Handed)**



- Big handle Ø22mm
- Anodised aluminium handle
- Stainless steel blade
- Right handed
- More power during operation
- Lightweight
- Snap on case back opener
- Bergeon 6987

Code	Description	UOM	Price
C40303	Bergeon Swiss, Metal Handle (Right Handed)	EACH	£39.95

**Bergeon Swiss Spare Blade (Left Handed)**



- Spare Blade for Product Code C40302

Code	Description	UOM	Price
C40312	Bergeon Swiss Spare Blade (Left Handed)	EACH	£6.50

**Bergeon Swiss Spare Blade (Right Handed)**



- Spare Blade for Product Code C40303

Code	Description	UOM	Price
C40311	Bergeon Swiss Spare Blade (Right Handed)	EACH	£6.50

**PRICE PROMISE GUARANTEE** ✓

**Chinese, Plastic Handle (Left Handed)**

**VALUE**



- Big Handle, Ø20mm
- Overall length: 130mm
- More power during operation
- Lightweight
- Snap on case back opener
- Left handed blade
- Made in China

Code	Description	UOM	Price
C38062	Chinese, Plastic Handle (Left Handed)	EACH	£6.95

**Chinese, Plastic Handle (Right Handed)**

**VALUE**



- Big Handle, Ø20mm
- Overall length: 130mm
- More power during operation
- Lightweight
- Snap on case back opener
- Right handed blade
- Made in China

Code	Description	UOM	Price
C38061	Chinese, Plastic Handle (Right Handed)	EACH	£6.95

**Chinese, Metal Handle (Right Handed)**

**VALUE**



- Big Handle, Ø22mm
- Overall length: 140mm
- More Power During Operation
- Snap On Case Back Opener
- Made in China

Code	Description	UOM	Price
C38212	Chinese, Metal Handle (Right Handed)	EACH	£9.95

**TODAY SAME DAY DISPATCH**

**Horotec Swiss, Metal Handle (Right Handed)**



- Big handle
- More power during operation
- Lightweight
- Snap on case back opener
- Horotec Swiss MSA 07.026

Code	Description	UOM	Price
C32258	Horotec Swiss, Metal Handle (Right Handed)	EACH	£29.95

**Horotec Swiss Spare Blade**



- Spare Blade for Product Code C32258

Code	Description	UOM	Price
C32269	Horotec Swiss Spare Blade	EACH	£13.95

**Hand Held Lever Case Openers**

Case Back Opening Tools - Snap On Watch Case Backs - Hand Held

A selection of the most popular "hand held" snap on watch case back opening tools.

Types:

- Knife blade
- Lever
- Microshock
- Scoop

**2 Lever, Non Swiss**



- For "Snap On" back covers
- Side mounted blade
- Green plastic handle
- Length: 140 mm

Code	Description	UOM	Price
C38059	2 Lever, Non Swiss	EACH	£6.95

**2 Lever, Bergeon Swiss**



Case Back Opener with 2 Levers (Snap On Type)

- Bergeon 6484
- For "Snap On" back covers
- Side mounted blade
- Green plastic handle
- Length: 140 mm

Code	Description	UOM	Price
C0307	2 Lever, Bergeon Swiss	EACH	£29.95

**Micro-choc, Horotec Swiss**



Horotec 07.004 - Swiss Made

A case opener suitable for opening all cases with "snap-on" backs and for removing friction-fit case bezels. This fine quality tool, of robust construction can be used both as a simple opening lever or with a dual action as a punch, activated by an internal hammer. The strength of the choc (shock) is adjustable by screwing (+ power) or unscrewing (- power) the handle depending on the tightness of the case back.

- 3 shaped blades, Ø3.50, 4.50 & 5.00mm
- Hardened steel blades, polished to a mirror finish
- Swiss Made
- Horotec 07.004

Code	Description	UOM	Price
C0310	Micro-choc, Horotec Swiss	EACH	£55.45

**Scoop Blade, A\*F Swiss**



Etic 350.155 - Swiss Made

An original tool with hollowed-out cylindrical blade in hardened steel. Uses a rolling motion to open snap-back watch cases.

- Length 130mm

Code	Description	UOM	Price
C0309	Scoop Blade, A*F Swiss	EACH	£19.70

**Scoop Blade, Cousins Swiss Style**



- For "Snap On" back covers
- Front mounted Scoop blade
- Green plastic handle

- Length: 130mm
- Made in India

Code	Description	UOM	Price
C38060	Scoop Blade, Cousins Swiss Style	EACH	£6.95

**Scoop Blade, Non Swiss**



Non Swiss

A copy of the original tool with hollowed-out cylindrical blade in hardened steel. Uses a rolling motion to open snap-back watch cases.

- Length 130mm

Code	Description	UOM	Price
C36501	Scoop Blade, Non Swiss	EACH	£1.95

**Seiko Style, Steel**



- Yellow plastic handle
- Steel blade

Code	Description	UOM	Price
C36349	Seiko Style, Steel	EACH	£1.95

**Seiko Style, Stainless Steel**



- Orange plastic handle
- Stainless steel blade

Code	Description	UOM	Price
C20800	Seiko Style, Stainless Steel	EACH	£3.50

**Seiko Style, Stainless Steel, Narrow Tip**



- Brown plastic handle with stainless steel narrow blade.
- 85 x 45mm
- 28g

Code	Description	UOM	Price
C32766	Seiko Style, Stainless Steel, Narrow Tip	EACH	£8.95

**PRICE PROMISE GUARANTEE**

**Protection Labels for Watch Glasses**

**See Page 1193**



**CASE OPENING - SOWAR PRIMA**

**Sowar Prima Case Openers**



- Sowar Prima case openers
- Set of 8 case openers
- Steel openers

Code	Description	UOM	Price
C47056	Sowar Prima Case Openers	PACK*8	£9.95

**CASE OPENING - SUCTION GRIP**

**Suction Grip Bergeon**

Bergeon 2533 - Swiss Made

- Rubber tipped Ø23mm
- Rubber opening key for opening and closing cases of waterproof watches
- Handy for starting threads
- Will not open very tight backs



Code	Description	UOM	Price
C0340	Suction Grip, Bergeon 2533	EACH	£12.95

**Suction Grip, Far East**

- Rubber tipped Ø23mm
- Rubber opening key for opening and closing cases of waterproof watches
- Handy for starting threads
- Will not open very tight backs



Code	Description	UOM	Price
C36467	Suction Grip, Far East	EACH	£2.25

**Suction Grip Disc (Ø60mm)**



- Rubber opening key for opening and closing cases of waterproof watches
- Double Sided
- Suitable for Case Backs Up Ø60mm
- Very Simple & Easy to Use
- Handy for starting threads
- Will not open very tight backs

Code	Description	UOM	Price
C32059	Suction Grip Disc (Ø60mm)	EACH	£2.20

**Suction Grip Ball, Ø60mm**



- Ø60mm
- Suction/friction action case opener
- Handy for starting threads
- Will not open very tight case backs
- Colour may vary

Code	Description	UOM	Price
C44831	Suction Grip Ball, Ø60mm	EACH	£3.50

**Suction Grip Dies with Holder, Cousins**



Upper dies in aluminium fitted with synthetic rubber rings for opening screw back watch cases. Excellent grip for opening the tightest cases.

- Large black plastic, easy grip handle (Ø65mm)
- 10 suction dies: Ø15, 20, 22, 25, 30, 33, 40, 45, 50 & 55mm
- Dies easily interchangeable via screw lock
- Excellent tool and brilliant value

Universal Fitting Dies for Tools:

- Bergeon Swiss
- Horotec Swiss
- Swiss Style

Fitting:

- Universal = dies fit directly on to the tools

Code	Description	UOM	Price
C45609	Cousins Suction Dies and Handle	EACH	£65.85
C47919	Ø15mm Suction Die	EACH	£4.95
C47920	Ø20mm Suction Die	EACH	£4.95
C47921	Ø22mm Suction Die	EACH	£4.95
C47922	Ø25mm Suction Die	EACH	£5.95
C47923	Ø30mm Suction Die	EACH	£5.95
C47924	Ø33mm Suction Die	EACH	£5.95
C47925	Ø40mm Suction Die	EACH	£6.95
C47926	Ø45mm Suction Die	EACH	£7.50
C47927	Ø50mm Suction Die	EACH	£7.95
C47928	Ø55mm Suction Die	EACH	£8.50
C48844	Handle	EACH	£14.95

**Suction Grip Dies, Hard**



Bergeon 5700-62 Series (Adiprene)  
Horotec 07.325 Series (Synthetic Blue)

Upper or lower fitting hard adiprene suction dies in aluminium with increased adherence for opening/closing screw on case backs. Less flexible than the soft adiprene series it is a slightly deformable material that adapts to the case & case back shape. For optimal adherence, remove all traces of grease or dust on the synthetic material and case & case back, using a cloth stocked with an alcohol cleaning fluid.

Universal Fitting Dies for Tools:

- Bergeon Swiss
- Horotec Swiss
- Swiss Style

Fitting:

- Universal = dies fit directly on to the tools

Code	Description	UOM	Price
C47837	Ø16mm (Hard) Bergeon	EACH	£31.50
C47853	Ø16mm (Hard) Horotec	EACH	£20.45
C47838	Ø19mm (Hard) Bergeon	EACH	£31.50
C47854	Ø20mm (Hard) Horotec	EACH	£21.25
C47839	Ø22mm (Hard) Bergeon	EACH	£31.50
C47855	Ø23mm (Hard) Horotec	EACH	£21.50
C47840	Ø26mm (Hard) Bergeon	EACH	£31.50
C47856	Ø26mm (Hard) Horotec	EACH	£21.95
C47841	Ø30mm (Hard) Bergeon	EACH	£31.50
C47857	Ø30mm (Hard) Horotec	EACH	£32.50
C47842	Ø34mm (Hard) Bergeon	EACH	£34.75
C47858	Ø34mm (Hard) Horotec	EACH	£27.75
B33551	Ø40mm (Hard) Bergeon	EACH	£34.75
C47859	Ø40mm (Hard) Horotec	EACH	£29.45
B33552	Ø45mm (Hard) Bergeon	EACH	£34.75
C47860	Ø45mm (Hard) Horotec	EACH	£31.95
B33553	Ø50mm (Hard) Bergeon	EACH	£34.75

**Suction Grip Dies, Soft**



Bergeon 5700-52 Series (Adiprene)  
Horotec 07.333 Series (Synthetic Red)

Upper or lower fitting soft adiprene suction dies in aluminium with increased adherence for opening/closing screw on case backs. More flexible than the

hard adiprene series it is a slightly deformable material that adapts to the case & case back shape. For optimal adherence, remove all traces of grease or dust on the synthetic material and case & case back, using a cloth stocked with an alcohol cleaning fluid.

Universal Fitting Dies for Tools:

- Bergeon Swiss
- Horotec Swiss
- Swiss Style

Fitting:

- Universal = dies fit directly on to the tools

Code	Description	UOM	Price
C47830	Ø16mm (Soft) Bergeon	EACH	£29.95
C47843	Ø16mm (Soft) Horotec	EACH	£29.95
C47831	Ø19mm (Soft) Bergeon	EACH	£29.95
C47844	Ø20mm (Soft) Horotec	EACH	£29.95
C47832	Ø22mm (Soft) Bergeon	EACH	£29.95
C47845	Ø23mm (Soft) Horotec	EACH	£29.95
C47833	Ø26mm (Soft) Bergeon	EACH	£29.95
C47846	Ø26mm (Soft) Horotec	EACH	£29.95
C47834	Ø30mm (Soft) Bergeon	EACH	£31.50
C47847	Ø30mm (Soft) Horotec	EACH	£29.95
C47835	Ø34mm (Soft) Bergeon	EACH	£34.75
C47848	Ø34mm (Soft) Horotec	EACH	£29.95
B33548	Ø40mm (Soft) Bergeon	EACH	£34.75
C47849	Ø40mm (Soft) Horotec	EACH	£29.95
B33549	Ø45mm (Soft) Bergeon	EACH	£34.75
C47850	Ø45mm (Soft) Horotec	EACH	£32.95
B33550	Ø50mm (Soft) Bergeon	EACH	£34.75
C47851	Ø50mm (Soft) Horotec	EACH	£45.50
C47852	Ø55mm (Soft) Horotec	EACH	£54.65

## Suction Grip Dies, Sets



Bergeon Swiss Made (Adiprene)  
Horotec Swiss Made (Synthetic Blue/Red)

Upper or lower fitting suction dies in aluminium with increased adherence for opening/closing screw on case backs. Deformable material that adapts to the case & case back shape. For optimal adherence, remove all traces of grease or dust on the synthetic material and case back, using a cloth stocked with an alcohol cleaning fluid.

- Soft: More flexible than the hard adiprene series it is a deformable material that adapts to the case & case back shape
- Hard: Less flexible, it is a slightly deformable material that adapts to the case & case back shape

Universal Fitting Dies for Tools:

- Bergeon Swiss
- Horotec Swiss
- Swiss Style

Fitting:

- Universal = dies fit directly on to the tools

See website "more info" for further specification

## Soft Suction, Bergeon 5700.03



Bergeon 5700.03

- Die set for gripping watch cases & case backs
- 3 dies: Ø19, 26 & 34mm
- Supplied with wooden stand

Code	Description	UOM	Price
C0326	Soft Suction, Bergeon 5700.03	PACK*3	£105.00

## Soft Suction, Bergeon 5700.52



Bergeon 5700-52

- Die set for gripping watch cases & case backs
- 9 dies: Ø16, 19, 22, 26, 30, 34, 40, 45 & 50mm
- Supplied with stand

Code	Description	UOM	Price
C47829	Soft Suction, Bergeon 5700.52	PACK*9	£254.95

## Soft Suction, Horotec 07.333



Horotec 07.333

- Die set for gripping watch cases & case backs
- 7 dies: Ø16, 20, 23, 26, 30, 34 & 40mm

Code	Description	UOM	Price
C47870	Soft Suction, Horotec 07.333	PACK*7	£144.75

## Soft Suction, Horotec 07.339



Horotec 07.339

- Die set for gripping watch cases & case backs
- 3 dies: Ø45, 50 & 55mm

Code	Description	UOM	Price
C47871	Soft Suction, Horotec 07.339	PACK*3	£115.00

## Soft Suction, Horotec 07.343



Horotec 07.343

- Die set for gripping watch cases & case backs
- 10 dies: Ø16, 20, 23, 26, 30, 34, 40, 45, 50 & 55mm

Code	Description	UOM	Price
C47869	Soft Suction, Horotec 07.343	PACK*10	£264.95

## Hard Suction, Bergeon 5700.62



Bergeon 5700-62

- Die set for gripping watch cases & case backs
- 9 dies: Ø16, 19, 22, 26, 30, 34, 40, 45 & 50mm
- Supplied with stand

Code	Description	UOM	Price
C47836	Hard Suction, Bergeon 5700.62	PACK*9	£254.95

**TODAY** SAME DAY DISPATCH

 **CUSTOMER SERVICE  
SECOND TO NONE**

Horotec Watch  
Case Suction Die

See Page 1073



**+ Contact  
& Services**

Your direct line to our  
**Management Team**

All correspondence is time stamped  
and answered within 1 hour of receipt

**Hard Suction, Bergeon 5700-62-6**



Bergeon 5700-62-6  
 • Die set for gripping watch cases & case backs  
 • 6 dies: Ø16, 19, 22, 26, 30 & 34mm  
 • Supplied with wooden stand

Code	Description	UOM	Price
C0325	Hard Suction, Bergeon 5700-62-6	PACK*6	£159.95

**Hard Suction, Horotec 07.325**



Horotec 07.325  
 • Die set for gripping watch cases & case backs  
 • 7 dies: Ø16, 20, 23, 26, 30, 34 & 40mm

Code	Description	UOM	Price
C47872	Hard Suction, Horotec 07.325	PACK*7	£136.95

**CASE OPENING - TWIST ACTION (HAND HELD)**

**Hand Turn (up to 35mm) Slot Jaws, A\*F Swiss**



A\*F Swiss 167.760

Popular case opener for screw back cases. Usable with the right or left hand thanks to the locking screw which fixes on either side. In blue anodised aluminium, sliding jaws in hard steel.

- Adjustable
- Blue anodised
- Aluminium body
- Steel jaws

• For right or left hand

Code	Description	UOM	Price
C0313	Hand Turn (up to 35mm) A*F Swiss	EACH	£45.95

**Hand Turn (up to Ø50mm) Slot Jaws**



- Screw back watch case opener
- Hardened precision ground tips mounted on fine tolerance threads
- Machined guides for rigidity
- Capacity 12 to 50mm
- Adjustable
- For right or left hand

Code	Description	UOM	Price
C8966	Hand Turn (up to Ø50mm)	EACH	£7.50

**Hand Turn (up to Ø65mm) Universal**



Universal case opener with interchangeable bits suitable for watch cases with flats, slots, holes & oyster fittings.

- Screw back watch case opener
- Can accommodate cases up to Ø65mm
- Adjustable
- For right or left hand
- with Jaxa style bits (4 pairs)
- Bits can be filed and adapted to suit

Code	Description	UOM	Price
C37243	Hand Turn (up to Ø65mm)	EACH	£4.95

**Hand Turn (up to Ø70mm) Round Jaws**



- For big size cases
- Up to Ø70mm watch case
- With round jaws

Code	Description	UOM	Price
C42903	Hand Turn (up to Ø70mm) Round Jaws	EACH	£4.50

**Hand Turn (up to Ø70mm) Slot Jaws**



- For big size cases
- Up to Ø70mm watch case
- With slot jaws

Code	Description	UOM	Price
C32395	Hand Turn (up to Ø70mm) Slot Jaws	EACH	£3.85

**Straight Double Arm, up to Ø54mm, Bergeon (Polygonal)**



Bergeon 5338-XL-C Swiss Made

For waterproof polygonal cases the chucks are mobile and grip the case back perfectly, whether these are 6-8-10-12 or 14 sided. The reverse side of the wrench is used for holding other types of chucks. Maximum width 54mm

Contents:

- 1 Wrench
- 4 chucks for polygonal cases
- 2 chucks for cases with slots
- 2 chucks for cases with holes
- 2 chucks for oyster cases
- 2 chucks for aquastar cases
- 2 chucks for cases with curved sides

Code	Description	UOM	Price
C0317	Straight Double Arm, up to Ø54mm, Bergeon (Polygonal)	EACH	£142.50

**Straight Double Arm, up to Ø65mm**



- For big size cases
- From 38 mm to 65mm watch case
- 5 different key tips

Code	Description	UOM	Price
C20253	Straight Double Arm, up to Ø65mm	EACH	£11.25

**PRICE PROMISE GUARANTEE** ✓

**SAME DAY DISPATCH**

**Straight Single Arm, up to Ø55mm**



- For big size cases
- Up to Ø55mm watch case
- Pin or Rectangular Tips
- Lever action movement

Code	Description	UOM	Price
C38064	Straight Single Arm, up to Ø55mm, Pin Tips	EACH	£6.95
C38063	Straight Single Arm, up to Ø55mm, Rectangle Tips	EACH	£6.95

**Straight V Arm, A\*F Swiss**



A\*F 16774 - Swiss Made - Case Back Opening Tools

- A\*F 16774 (C0312) - Lever Action
- A&F 16774.1 (C0312A) Replacement Tool Bits

Code	Description	UOM	Price
C0312A	A*F 16774.1 Tool Bit	PACK*2	£19.30

**T - Shape Lever Action, Cousins (Multi Tip)**

**VALUE**



- For big size cases
- Up to Ø55mm watch case
- 3 (x2) different key tips
- T - Shaped
- Made in far east

Code	Description	UOM	Price
C35128	Lever Action (Ø55mm) Opener, Multi Tip	EACH	£17.95

**T - Shape Lever Action, Horotec**



Horotec Lever Action

Slim design, easy to use on watches with integrated

bracelets, ladies watches or with any case where work space is very narrow.

- Horotec 07.014
- Can open cases up to Ø57mm
- Overall length 155mm
- Supplied with elongated square case bits
- For additional case opening bits see tool C22162
- Made in Switzerland

Code	Description	UOM	Price
C41143	Lever Action	EACH	£37.95

**CASE OPENING - UNIVERSAL, BERGEON**

*Offers Maximum Flexibility and Interchangeability with Dies.*

*The majority of case back dies we sell for our universal case back removing & fitting tools (Bergeon, Horotec & Swiss Style) are all interchangeable with each other.*

- All Universal dies fit directly on to the tools
- All Universal with Adapter dies fit on to the tools using adaptor C0318 or C39846

**Universal Case Back Tool, Bergeon 5700z Swiss**



Bergeon 5700z

New base (250 x 95mm) and jaw holder especially created for big cases, opening up 60mm. Large ergonomic top wheel (Ø130mm) for ease of opening and closing on a die cast frame, total height 300mm. Large range of additional accessories, plus a Bergeon forward thinking programme of manufacturing future requirements.

Contents:

- Adjustable jaw holder, maximum opening 60mm
- 6 pairs of pins (hardened steel)
- 4 pairs of case holding jaws

Offers Maximum Flexibility and Interchangeability with Dies.

The majority of case back dies we sell for our universal case back removing & fitting tools (Bergeon, Horotec & Swiss Style) are all interchangeable with each other.

- All Universal dies fit directly on to the tools
- All Universal with Adapter dies fit on to the tools using adaptor C0318 or C39846

**Bergeon 5700Z Complete Tool (New Version)**



Bergeon 5700z

Contents:

- Adjustable jaw holder, maximum opening 60mm
- 6 pairs of pins (hardened steel)
- 4 pairs of case holding jaws

Offers Maximum Flexibility and Interchangeability with Dies.

The majority of case back dies we sell for our universal case back removing & fitting tools (Bergeon, Horotec & Swiss Style) are all interchangeable with each other.

- All Universal dies fit directly on to the tools
- All Universal with Adapter dies fit on to the tools using adaptor C0318 or C39846

Code	Description	UOM	Price
C35045	Bergeon 5700Z Complete Tool (New Version)	EACH	£450.00

**Big Diameter Case Adaptor, Bergeon 5700.04.G**



- Vice Stake Holder for Extra Wide Cases
- Opening up to 60mm
- Already Included with 5700Z (C35045)
- Suitable for 5700 & 5700Z Case Opener

Code	Description	UOM	Price
C32172	Big Diameter Case Adaptor, Bergeon 5700.04.G	EACH	£119.95

**Watch Case Holder, Bergeon 5674**



- To be used with Bergeon 5700 Series
- Replacement Jaws C4350

Code	Description	UOM	Price
C0301	Watch Case Holder, Bergeon 5674	EACH	£43.95

PRICE PROMISE GUARANTEE



**SAME DAY DISPATCH**

**Bergeon 5674D  
Watch Case Holder  
Jaw**

- Replacement Jaw for tool Bergeon 5674 (C0301)
- Bergeon 5674D



Code	Description	UOM	Price
C4350	Bergeon 5674D Watch Case Holder Jaw	EACH	£3.45

**CASE OPENING -  
UNIVERSAL, HOROTEC**

*Offers Maximum Flexibility and Interchangeability with Dies.*

*The majority of case back dies we sell for our universal case back removing & fitting tools (Bergeon, Horotec & Swiss Style) are all interchangeable with each other.*

- All Universal dies fit directly on to the tools
- All Universal with Adapter dies fit on to the tools using adaptor C0318 or C39846

**Universal Case Back Tool, Horotec**



Horotec 07.361

Horotec professional precision press. Heavy and robust, built in steel and aluminium. Equipped with removable and adjustable watch holder with 4 Delrin dies to hold the watch cases securely and horizontally. Excellent frontal, lateral or plunging view. Large ergonomic top wheel (Ø160mm) for ease of opening and closing screw on case backs

Contents:

- Adjustable jaw holder, maximum opening 65mm
- 4 pairs of jaws (round, flat, square, knurled)
- Watch holder with 4 concave dies (height 18mm, max opening 70mm)
- 7 case back suction dies, Ø16 to 40mm

Offers Maximum Flexibility and Interchangeability with Dies.

The majority of case back dies we sell for our universal case back removing & fitting tools (Bergeon, Horotec & Swiss Style) are all interchangeable with each other.

- All Universal dies fit directly on to the tools
- All Universal with Adapter dies fit on to the tools using adaptor C0318 or C39846

Code	Description	UOM	Price
C44241	Horotec "All Purpose" Tool - Professional	EACH	£475.00

**Universal Case Back Tool,  
Horotec Compact**



Horotec 07.320

Contents:

- Adjustable jaw holder, maximum opening 65mm
- 4 pairs of jaws (round, flat, square, knurled)
- Watch holder with 4 concave dies (height 18mm, max opening 70mm)

Offers Maximum Flexibility and Interchangeability with Dies.

The majority of case back dies we sell for our universal case back removing & fitting tools (Bergeon, Horotec & Swiss Style) are all interchangeable with each other.

- All Universal dies fit directly on to the tools
- All Universal with Adapter dies fit on to the tools using adaptor C0318 or C39846

Code	Description	UOM	Price
C22162	Universal Case Back Tool, Horotec Compact	EACH	£235.00

**Adjustable Jaw Holder (65mm),  
Horotec**



Horotec 07.344

- For tool 07.320 (C22162)
- Maximum opening 65mm

Code	Description	UOM	Price
C32774	Adjustable Jaw Holder (65mm), Horotec	EACH	£121.10

**Universal Case Back Tool,  
Case Holding Pegs**



Universal Case Back Tool - Case Holding Pegs

- Stacked or concave pegs
- Can be used with either tool C22612 or C44214

- Horotec Swiss

Dimensions:

- Peg delrin height (diameter at the top x diameter at the bottom), Horotec reference

Code	Description	UOM	Price
C38256	13.5mm (Ø9.20 x Ø12mm) Concave Peg, Horotec 07.322	EACH	£5.95
C47863	18mm (Ø9 x Ø12mm) Concave Peg, Horotec 07.360.B	EACH	£6.50
C47862	20mm (Ø10 x Ø14mm) Stacked Peg, Horotec 07.374.A	EACH	£11.75

**Universal Case Back Tool,  
Suction Case Holder**

Horotec 07.367.A

- Can be used with either tool C22612 or C44214
- Holds any shape case
- Diameter Ø62mm
- Horotec Swiss



Code	Description	UOM	Price
C44247	Ø62mm Case Holder, Suction	EACH	£139.95

**When Corporatism  
leads to corporate  
governance failure,  
the case of the Swiss  
watch industry.**

*Available to buy as a  
paperback or free to  
download via our  
online pdf link*

**£9.00**  
Ref: C48921





**Horotec Die Storage Rack**



Horotec 07.370

- Holds 9 dies
- Removeable tray (fits to the Horotec tool)
- Can be used in conjunction with our tool Horotec C44241 (Horotec 07.361)
- Can also be used with Horotec tools 07.360, 07.362, 07.364 & 07.365
- Horotec Swiss

Code	Description	UOM	Price
C47861	Die Storage Rack, Horotec 07.370	EACH	£62.95

**Horotec Hand Held Die Holder**



Horotec Swiss 07.305

Will take all Universal dies that fit directly on to the tools.

- Bergeon Swiss
- Horotec Swiss
- Swiss Style

Fitting:

- Universal = dies fit directly on to the tools
- Universal with Adapter = dies fit on to the tools using adaptor C0318 or C39846

You can also fit other available individual dies (Baume & Mercier, Breitling, Citizen, Omega, Paneria, Rolex)

Code	Description	UOM	Price
M32675	Universal Die Holder, Horotec	EACH	£39.95

**Rolex Oyster & Sea Dweller Case Back Opener**



See Page 1064

**CASE OPENING - UNIVERSAL, SWISS STYLE**

**Universal Case Back Tool, Swiss Style**

**VALUE**



Swiss Style

Wooden base (250 x 100mm) and jaw holder especially created for big cases, opening up 60mm. Large ergonomic top wheel (Ø150mm) for ease of opening and closing on a die cast frame, total height 300mm.

Contents:

- Adjustable jaw holder, maximum opening 60mm
- 6 pairs of pins (hardened steel)
- 4 pairs of case holding jaws

Offers Maximum Flexibility and Interchangeability with Dies.

The majority of case back dies we sell for our universal case back removing & fitting tools (Bergeon, Horotec & Swiss Style) are all interchangeable with each other.

- All Universal dies fit directly on to the tools
- All Universal with Adapter dies fit on to the tools using adaptor C0318 or C39846

Code	Description	UOM	Price
C38205	Universal Case Back Tool, Swiss Style	EACH	£150.00

**CASE OPENING - UNIVERSAL ACCESSORIES & FITTINGS**

**Case Holding Jaws**



Universal Case Back Opening Tool - Holding Jaws

Reversible case holding jaws, in synthetic material to protect watch cases.

Universal Fitting Case Opening jaws for Tools:  
• Bergeon Swiss

- Horotec Swiss
- Swiss Style

Fitting:

- Universal = jaws fit directly on to the tools listed above

Code	Description	UOM	Price
C32290	9-11mm, Bergeon	EACH	£3.15
C47864	9-11mm, Horotec	EACH	£5.50
C47873	9-11mm, Swiss Style	EACH	£2.75
C32291	13-15mm, Bergeon	EACH	£3.15
C47865	13-15mm, Horotec	EACH	£5.50
C47874	13-15mm, Swiss Style	EACH	£2.75
C7050	17-19mm, Bergeon	EACH	£3.15
C47866	17-19mm, Horotec	EACH	£5.95
C47875	17-19mm, Swiss Style	EACH	£2.75
C0316A	20-22mm, Bergeon	EACH	£3.15
C47867	20-22mm, Horotec	EACH	£5.95
C47876	20-22mm, Swiss Style	EACH	£2.75

**Case Holding Jaws, Style 2**



Universal Case Back Opening Tool - Holding Jaws

Reversible case holding jaws, in synthetic material to protect watch cases.

Universal Fitting Case Opening jaws for Tools:

- Bergeon Swiss
- Horotec Swiss
- Swiss Style

Fitting:

- Universal = jaws fit directly on to the tools listed above

Code	Description	UOM	Price
C32281	Set of Jaws, Bergeon 5700RU	PACK*6	£62.95
C32277	9-11mm, Bergeon 5700R	EACH	£7.75
C32278	13-15mm, Bergeon 5700S	EACH	£7.95
C32279	17-19mm, Bergeon 5700T	EACH	£8.55
C32280	20-22mm, Bergeon 5700U	EACH	£8.55

**Case Holding Jaws, Style 3**



Universal Case Back Opening Tool - Holding Jaws

Reversible case holding jaws, in synthetic material to protect watch cases.

Universal Fitting Case Opening jaws for Tools:

- Bergeon Swiss
- Horotec Swiss
- Swiss Style

Fitting:

- Universal = jaws fit directly on to the tools listed above

Code	Description	UOM	Price
C32286	Set of Jaws, Bergeon 5700VY	PACK*6	£81.00
C32282	9-11mm, Bergeon 5700V	EACH	£8.95
C32283	13-15mm, Bergeon 5700W	EACH	£8.15
C32284	17-19mm, Bergeon 5700X	EACH	£9.30

### Case Opening Bits



Case Opening Tool Bits - Universal

Replacement tool bits for universal case opening tools

Universal Fitting Case Opening bits for Tools:

- Bergeon Swiss
- Horotec Swiss
- Swiss Style

Fitting:

- Universal = bits fit directly on to the tools listed above

Code	Description	UOM	Price
C0319	Slots (A), Bergeon	EACH	£5.65
C38254	Slots (A), Horotec	EACH	£6.40
T47005	Slots (A), Swiss Style	PACK*2	£5.95
C41759	Slots Elongated (B), Horotec	EACH	£9.25
C0320	Polygonal (C), Bergeon	EACH	£4.50
C38253	Polygonal (C), Horotec	EACH	£6.40
T47006	Polygonal (C), Swiss Style	PACK*2	£5.95
C38252	Holes (D), Horotec	EACH	£6.40
T47007	Holes (D), Swiss Style	PACK*2	£5.95
C47868	Holes Elongated (E), Horotec	EACH	£8.95
C0322	Grooved (F), Bergeon (Rolex Oyster Type)	EACH	£4.95
C38255	Grooved (F), Horotec	EACH	£6.40
T47009	Grooved (F), Swiss Style (Rolex Oyster Type)	PACK*2	£5.95
C0323	Curved Sides (G), Bergeon	EACH	£5.60
C0324	Aquastar (H), Bergeon	EACH	£6.00
C0321	Points (I), Bergeon	EACH	£4.15
T47008	Points (I), Swiss Style	PACK*2	£5.95

### Universal Adaptor

Universal die adaptor for fitting our "Universal" tools:

- Bergeon Swiss
- Horotec Swiss
- Swiss Style

The tools in the above categories accept all our "Universal" case back dies which fit directly on to the tools.



Dies that are described as "Universal with Adapter" fit on to the tools using these adaptors C0318 (Bergeon 5538T) or C39846 (Non Swiss)

Code	Description	UOM	Price
C0318	Rolex Oyster Adaptor, Bergeon 5538T	EACH	£30.95
C39846	Rolex Oyster Adaptor, Non Swiss	EACH	£19.95

### Universal Adapter for Screw on Dies



Universal Case Back Opening Tool - Adapter for Screw on Dies - Horotec Swiss

Adapters to allow case opening tools & presses to take screw on dies. Use with all screw-on dies with a thread of 6mm.

Universal Fitting screw on die adapter for Tools:

- Bergeon Swiss
- Horotec Swiss
- Swiss Style

Fitting:

- Universal = Adapters fit directly on to the tools listed above

Horotec Swiss

- 07.373.A (D47901) Upper Die
- 07.373.B (D47902) Lower Die

Code	Description	UOM	Price
D47902	Lower Adapter for Screw On Dies	EACH	£15.95
D47901	Upper Adapter for Screw On Dies	EACH	£4.85

## GLASS CLAW FITTING TOOL

Model for removing unbreakable round watch glasses

Simple removal and re-fitting of front fitting round acrylic watch glasses.

The new glass is gripped and lifted from the platform with pre-depth leading edge for inserting into the bezel and releasing.

### Round Glasses (Superior)

Tool for removing unbreakable round watch glasses

Simple removal and re-fitting of front fitting round, acrylic watch glasses.

The new glass is gripped and lifted from the platform with pre-depth leading edge for inserting into the bezel and releasing.

- Crystal lift with base
- Superior manufactured quality tool
- Smooth finished, high quality brass jaws, will not damage the glass
- Body made from pure aluminium
- Claw capacity: Ø10mm to Ø50mm
- Platform capacity: Ø10mm to Ø40mm
- Handle diameter Ø40mm
- Overall height 70mm



- Made in India

Code	Description	UOM	Price
G39723	Round Glass Tool	EACH	£13.95
G37924	Round Glass Tool Spring	EACH	£8.95

### Round Glasses, Bergeon 4266

Model for removing unbreakable round watch glasses

- Bergeon 4266 Swiss Made
- Crystal Lift with Base
- Capacity: Ø10.0mm to Ø45.0mm



Code	Description	UOM	Price
G0719	Round Glasses, Bergeon 4266	EACH	£44.50

### Tonneau Shaped Adapter, Bergeon 4266.1

- Bergeon 4266.1 for tool 4266 (G0719)
- Specially designed ring that fit onto the crystal lift
- To fit Tonneau shaped glasses



Dimensions:

- Min: 10 x 13mm
- Max: 25 x 30mm

Code	Description	UOM	Price
G0716	Tonneau Shaped Adapter, Bergeon 4266.1	EACH	£14.95

### Cushion Shaped Adapter, Bergeon 4266.2

- Bergeon 4266.2 for tool 4266 (G0719)
- Specially designed ring that fit onto the crystal lift
- To fit Cushion shaped glasses



Dimensions:

- Min: 12 x 12mm
- Max: 40 x 40mm

Code	Description	UOM	Price
G0717	Cushion Shaped Adapter, Bergeon 4266.2	EACH	£14.95

### Oval Shaped Adapter, Bergeon 4266.3

- Bergeon 4266.3 for tool 4266 (G0719)
- Specially designed ring that fit onto the crystal lift
- To fit Oval shaped glasses



Dimensions:

- Min: 11 x 15mm
- Max: 28 x 35mm

Code	Description	UOM	Price
G0718	Oval Shaped Adapter, Bergeon 4266.3	EACH	£14.95



ONLINE ORDER STATUS

**Platform for Standard Crystals, Bergeon 4266E**



- Bergeon 4266E for tool 4266
- Standard platform lip height is 0.70mm

Code	Description	UOM	Price
P22029	Platform for Standard Crystals, Bergeon 4266E	EACH	£10.75

**Round & Shaped Glasses, Bergeon 6400**



- Model for removing unbreakable round & shaped watch glasses
- Bergeon 6400 Swiss Made
  - Crystal Lift with Base
  - Capacity: Ø10.0mm to Ø45.0mm

Code	Description	UOM	Price
G0720	Round & Shaped Glasses, Bergeon 6400	EACH	£62.95

**Internal Gasket, Bergeon 4266 & 6400**



- Bergeon 4266J
  - Ø20mm
- Inner compression ring, maintaining tension of jaws on tool 4266 (G0719) & 6400 (G0720)

Replacement ring. In rubber for tool No 6400.  
 Instructions for replacing the ring  
 " Unscrew completely the knurled black head screw.  
 " Pull out block with claws.  
 " Replace rubber ring.  
 " Re-assemble the tool.

Code	Description	UOM	Price
G7346	Internal Gasket, Bergeon 4266 & 6400	EACH	£2.50

**External Gasket, Bergeon 6400**



- Bergeon 6400D
- External Ø45mm

Code	Description	UOM	Price
G0720A	External Gasket, Bergeon 6400	EACH	£8.95

**Watch Glasses (High Dome)**

See Page 278



**Watch Glasses (Extra High)**

See Page 280



**GLASS REMOVING PUMP**

**Glass Removing Pump, Bergeon 5011**



- For removing unbreakable glasses from one piece watch cases
- Supplied with 3 heads: Ø 1.60 - 2.00 - 2.50 mm
- 1 key for removing the half-stem with the crown

With the split crown and stem removed the pump is applied to the case tube and as internal pressure builds the glass is forced out for access to movement.

Code	Description	UOM	Price
G0724	Glass Removing Pump, Bergeon 5011	EACH	£105.95
G0725	Ø1.60mm Glass Pump Nozzle	EACH	£4.50
G0726	Ø2.00mm Glass Pump Nozzle	EACH	£4.50
G0727	Ø2.50mm Glass Pump Nozzle	EACH	£4.50

**PRESS & DIES, A\*F SWISS**

**Screw Down Press, A\*F Swiss**



A\*F 179.140 Swiss Made

Robust press for the easy closing of watch cases with snap-on backs. Ideal for use in retail watch shops and at the point of sale. designed with non-technical staff in mind but equally useful to watchmakers.

Upper part of the tool is machined from steel and mounted on two heavy chrome plated pillars for maximum stability. The upper handle with three arms fits comfortably in the hand. To save time, the tool features a wide thread on the spindle for quick closing as well as a removable socket-type die holder to facilitate die changing. The aluminum base in an attractive blue anodised blue finish is stable enough to be used free standing but can also be screwed to the work bench if desired.

Supplied with 8 dies in tough nylon:

- 4 Reversible upper dies : Ø16/18, 20/22, 24/26, 28/30
- 1 Single die: Ø14mm
- 3 lower dies with bevelled edges Ø20, 25, 30mm (for watches with flat or domed glasses)
- For convenience, all dies are clearly marked with the diameter
- For extra dies also see sets D38224 & D38985

Dimensions:  
 • 120 x 70 x 155mm  
 • Weight: 1.4Kg

Code	Description	UOM	Price
C0311	"Maxi Press" A*F Swiss	EACH	£215.00
C0311E	Ø14mm Die	EACH	£13.50
C0311A	Ø16/18mm Die	EACH	£13.50
C0311B	Ø20/22mm Die	EACH	£13.50
C0311C	Ø24/26mm Die	EACH	£13.50
C0311D	Ø28/30mm Die	EACH	£13.50
C0311F	Ø20mm Die, Lower	EACH	£13.50
C0311G	Ø25mm Die, Lower	EACH	£13.50
C0311H	Ø30mm Die, Lower	EACH	£13.50

**PRESS & DIES, BERGEON**

**Rack Press, Bergeon 6173**



Bergeon 6173 - Swiss Made

Rack Press for multiple uses were additional precision is required when glass fitting and watch case back closing

- Supplied:
- Base, Press, Rack & Lever
  - 2 x Die Support Reduction Rings, Bergeon 6173R (D38258)
  - Upper Die Support, Bergeon 6173.ST2 (G34451)
  - Lower Die Support (21mm), Bergeon 5500-T21 (G19830)

Dimensions:  
 • Spindle: 20 mm  
 • Height of press: 200 mm  
 • Working height available max: 110 mm  
 • Base: 300 x 110 x 20 mm

Code	Description	UOM	Price
G0723	Glass Fitting & Case Closing Precision Press, Bergeon	EACH	£495.00
D38258	Reduction Ring, Bergeon 6173R	EACH	£22.25
G34451	Upper Die Support, Bergeon 6173.ST2	EACH	£3.75



**Universal Adapter for Screw on Dies**

See Page 1075



**Rack Press Micrometric Stop, Bergeon**



For Attaching to and use with Bergeon Precision Press 6173 (G0723)

- Bergeon 6173B
- Micrometric stop for rack press
- Easy adaptation on the press No 6173
- Anodized aluminium
- Adjustment by micrometric screw in hardened and tempered steel
- Precision: 0.01 mm graduation.

Press Micrometric Stop Bergeon 6173B. Attaches to tool 6173 (G0763) to provide a positive measured control stop on downward pressure and avoid excess load.

Code	Description	UOM	Price
G4870	Rack Press Micrometric Stop, Bergeon	EACH	£254.95

**Press & Die Set, Bergeon 5500A**



- Bergeon 5500A (Comprehensive)
- For fitting unbreakable crystals with or without tension ring
- On wooden stand
- Dimensions - 370 x 150mm

Item Includes:

- 1 press, Bergeon No.5500
- 1 Universal lower stake, Bergeon No.5500-31
- 1 Support Bergeon No.5500-T28
- 9 Curved Basic Lower Dies in Black Plastic with Metal Centre.

Sizes (Diameter):

Ø12, 14, 16, 20, 24, 28, 32, 36, 40mm

- 12 Aluminium Bevelled Upper Reversible Dies.

Sizes (Diameter):

Ø44/42, 40/38, 35/34, 33/32, 31/30, 29/28, 27/26mm  
Ø25/24, 23/22, 21/20, 19/18, 17/15mm

- 9 Aluminium Flat Reversible Lower Dies.

Sizes (Diameter):

Ø17/15, 19/18, 21/20, 23/22, 25/24mm  
Ø27/26, 29/28, 31/30, 33/32mm

Code	Description	UOM	Price
G0721	Press & Die Set, Bergeon 5500A	EACH	£415.00

**Press & Die Set, Bergeon 5500C**



- Bergeon 5500C (Reduced)
- For fitting unbreakable crystals with tension ring
- On wooden stand
- Dimensions - 200 x 150mm

Item Includes:

- 1 press, Bergeon No.5500
- 1 Universal lower Die, Bergeon No.5500-31
- 9 Aluminium Dies

- 9 Aluminium Bevelled Upper Reversible Dies.

Sizes (Diameter):

Ø35/34, 33/32, 31/30, 29/28, 27/26mm  
Ø25/24, 23/22, 21/20, 19/18mm

Code	Description	UOM	Price
G0722	Press & Die Set, Bergeon 5500C	EACH	£249.95

**Dies Individual, Bergeon**



Glass Fitting - Individual Dies - Bergeon

Replace or enhance your existing die set with individually available dies.

- Bergeon Swiss
- Bakelite Ø12mm to Ø40mm
- Aluminium Lower Ø12mm to Ø36mm
- Aluminium Upper Ø15mm to Ø48mm

Code	Description	UOM	Price
S34982	Ø12mm Bakelite Die	EACH	£7.25
S34983	Ø14mm Bakelite Die	EACH	£7.25
S34984	Ø16mm Bakelite Die	EACH	£7.25
S34985	Ø20mm Bakelite Die	EACH	£7.25
S34986	Ø24mm Bakelite Die	EACH	£7.25
S34987	Ø28mm Bakelite Die	EACH	£7.25
S34988	32mm Bakelite Die	EACH	£7.25
S34989	Ø36mm Bakelite Die	EACH	£7.25
S34990	Ø40mm Bakelite Die	EACH	£7.25
S35003	Lower Ø14/12mm Aluminium Die	EACH	£8.95
S35004	Lower Ø17/15mm Aluminium Die	EACH	£8.95
S35005	Lower Ø19/18mm Aluminium Die	EACH	£8.95
S35006	Lower Ø21/20mm Aluminium Die	EACH	£8.95
S35007	Lower Ø23/22mm Aluminium Die	EACH	£8.95
S35008	Lower Ø25/24mm Aluminium Die	EACH	£8.95
S35009	Lower Ø27/26mm Aluminium Die	EACH	£8.95
S35010	Lower Ø29/28mm Aluminium Die	EACH	£8.95
S35011	Lower Ø31/30mm Aluminium Die	EACH	£8.95
S35012	Lower Ø33/32mm Aluminium Die	EACH	£8.95
S35013	Lower Ø36/34mm Aluminium Die	EACH	£8.95
S34991	Upper Ø17/15mm Aluminium Die	EACH	£8.95

S34992	Upper Ø19/18mm Aluminium Die	EACH	£8.95
S34993	Upper Ø21/20mm Aluminium Die	EACH	£8.95
S34994	Upper Ø23/22mm Aluminium Die	EACH	£8.95
S34995	Upper Ø25/24mm Aluminium Die	EACH	£8.95
S34996	Upper Ø27/26mm Aluminium Die	EACH	£8.95
S34997	Upper Ø29/28mm Aluminium Die	EACH	£8.95
S34998	Upper Ø31/30mm Aluminium Die	EACH	£8.95
S34999	Upper Ø33/32mm Aluminium Die	EACH	£8.95
S35000	Upper Ø35/34mm Aluminium Die	EACH	£8.95
G7347	Upper Ø40/38mm Aluminium Die	EACH	£8.95
S35001	Upper Ø44/42mm Aluminium Die	EACH	£8.95
S35002	Upper Ø48/46mm Aluminium Die	EACH	£15.95

**Die Set, Bergeon 5500.A1**



Bergeon 5500.A1

- Assortment of 30 dies for fitting crystals
- Closes certain case backs
- To be used with presses G0721 (Bergeon No.5500) and G0723 (Bergeon No.6173)

Contains:

9 Curved Basic Lower Dies in Black Plastic with Metal Centre.

- Ø12, 14, 16, 20, 24, 28, 32, 36, 40mm

12 Aluminium Bevelled Upper Reversible Dies.

- Ø44/42, 40/38, 35/34, 33/32, 31/30, 29/28mm
- Ø27/26, 25/24, 23/22, 21/20, 19/18, 17/15mm

9 Aluminium Flat Reversible Lower Dies.

- Ø17/15, 19/18, 21/20, 23/22, 25/24mm
- Ø27/26, 29/28, 31/30, 33/32mm

1 Aluminium Universal Die for Cases with Large Horns or Bezel Claws

Code	Description	UOM	Price
G0721A	Die Set, Bergeon 5500.A1	EACH	£265.00

**Bezel Dies**



Bergeon 7499.A

- Assortment of 13 synthetic dies
- Brass core thread
- For fitting bezels
- Closes certain case backs
- To be used with presses G0721 (Bergeon No.5500) and G0723 (Bergeon No.6173)

Contains die sizes:

- Ø22/23, 24/25, 26/27, 28/29, 30/31, 32/33, 34/35, 36/37, 38/39, 40/41 42/43, 44/45 & 46/47mm

Code	Description	UOM	Price
D45951	Bezel Dies, Bergeon 7499.A	PACK*13	£156.50

**PRICE PROMISE GUARANTEE** ✓

**Glass Dies for Domed Minerals**



Bergeon 6527-6CP

- Assortment of 6 delrin (POM) dies with brass core, Thread M6
- Thickness 16mm
- For fitting domed mineral watch glasses
- Closes waterproof watch cases
- To be used with presses G0721 (Bergeon No.5500) and G0723 (Bergeon No.6173)

Die sizes (Diameter) -

- 19, 22, 26, 30, 35 & 40mm

Code	Description	UOM	Price
<b>B34686</b>	Glass Dies for Domed Minerals	PACK*6	<b>£79.95</b>
<b>S34974</b>	19mm Glass Fitting Die	EACH	<b>£18.75</b>
<b>S34975</b>	22mm Glass Fitting Die	EACH	<b>£18.75</b>
<b>S34976</b>	26mm Glass Fitting Die	EACH	<b>£18.75</b>
<b>S34977</b>	30mm Glass Fitting Die	EACH	<b>£18.75</b>
<b>S34978</b>	35mm Glass Fitting Die	EACH	<b>£18.75</b>
<b>S34979</b>	40mm Glass Fitting Die	EACH	<b>£18.75</b>

**Glass Dies for Domed Minerals, Extra Large**



Bergeon 6527-5CP-XL

- Assortment of 5 delrin (POM) dies without brass core, Thread M6
- Thickness 16mm
- For fitting extra large (XL) domed mineral watch glasses
- Closes waterproof watch cases
- To be used with presses G0721 (Bergeon No.5500) and G0723 (Bergeon No.6173)

Die sizes (Diameter) -

- 45, 50, 55, 60 & 65mm

Code	Description	UOM	Price
<b>S34962</b>	Glass Dies for Domed Minerals, Extra Large	PACK*5	<b>£82.95</b>
<b>S34963</b>	Glass Fitting Die, 45mm	EACH	<b>£23.95</b>
<b>S34964</b>	Glass Fitting Die, 45mm	EACH	<b>£23.95</b>
<b>S34965</b>	Glass Fitting Die, 55mm	EACH	<b>£23.95</b>
<b>S34966</b>	Glass Fitting Die, 60mm	EACH	<b>£23.95</b>
<b>S34967</b>	Glass Fitting Die, 65mm	EACH	<b>£23.95</b>

**Glass Dies for Domed Minerals, Extra Large, Aluminum**



Bergeon 5500-04-XL

- Reversible Aluminum Stakes
- Big Sizes

Die sizes (Diameter)-

- Ø52 x 50mm, Ø56 x 54mm
- Ø60 x 58mm, Ø64 x 62mm

Code	Description	UOM	Price
<b>S35014</b>	Glass Dies for Domed Minerals, Extra Large, Aluminum	PACK*4	<b>£72.95</b>
<b>S35015</b>	Ø52 x 50mm Glass Fitting Die	EACH	<b>£20.95</b>
<b>S35016</b>	Ø56 x 54mm Glass Fitting Die	EACH	<b>£20.95</b>
<b>S35017</b>	Ø60 x 58mm Glass Fitting Die	EACH	<b>£20.95</b>
<b>S35018</b>	Ø64 x 62mm Glass Fitting Die	EACH	<b>£20.95</b>

**Glass Dies for Flat Minerals**



Bergeon 6527-6P

- Assortment of 6 delrin (POM) dies with metal core, Thread M6
- Thickness 16mm
- For fitting flat mineral watch glasses
- Closes waterproof watch cases
- To be used with presses G0721 (Bergeon No.5500) and G0723 (Bergeon No.6173)

Die sizes (Diameter) -

- 19, 22, 26, 30, 35 & 40mm

Code	Description	UOM	Price
<b>D0422</b>	Glass Dies for Flat Minerals	PACK*6	<b>£79.95</b>
<b>S34968</b>	19mm Glass Fitting Die	EACH	<b>£13.95</b>
<b>S34969</b>	22mm Glass Fitting Die	EACH	<b>£13.95</b>
<b>S34970</b>	26mm Glass Fitting Die	EACH	<b>£13.95</b>
<b>S34971</b>	30mm Glass Fitting Die	EACH	<b>£13.95</b>
<b>S34972</b>	35mm Glass Fitting Die	EACH	<b>£16.95</b>
<b>S34973</b>	40mm Glass Fitting Die	EACH	<b>£16.95</b>

**Glass Dies for Flat Minerals, Extra Large**



Bergeon 6527-5P-XL

- Assortment of 5 delrin (POM) dies without metal core, Thread M6
- Thickness 16 mm
- For fitting extra large (XL) flat mineral watch glasses
- Closes waterproof watch cases
- To be used with presses G0721 (Bergeon No.5500) and G0723 (Bergeon No.6173)

Die Sizes (Diameter) -

- 45, 50, 55, 60 & 65mm

Code	Description	UOM	Price
<b>S34956</b>	Glass Dies for Flat Minerals, Extra Large	PACK*5	<b>£82.95</b>
<b>S34957</b>	Glass Fitting Die, 45mm	EACH	<b>£21.35</b>
<b>S34958</b>	Glass Fitting Die, 55mm	EACH	<b>£21.35</b>
<b>S34959</b>	Glass Fitting Die, 45mm	EACH	<b>£21.35</b>
<b>S34960</b>	Glass Fitting Die, 60mm	EACH	<b>£21.35</b>
<b>S34961</b>	Glass Fitting Die, 65mm	EACH	<b>£21.35</b>

**Glass Dies for Tension Rings**



Bergeon 5499.08 (set of 8)

Bergeon 5499.15 (set of 15)

- Assortment of 15 or 8 Aluminium Dies
- For Fitting Divers Armoured Tension Ring Acrylic Glasses
- Closes Certain Case Backs
- To be used with presses G0721 (Bergeon No.5500) and G0723 (Bergeon No.6173)

Set of 8 contains:

- Ø34.5/34, 33.5/33, 32.5/32, 31.5/31mm
- Ø30.5/30, 29.5/29, 28.5/28, 27.5/27mm

Set of 15 contains:

- Ø36.5/36, 35.5/35, 34.5/34, 33.5/33, 32.5/32, 31.5/31, 30.5/30mm
- Ø29.5/29, 27.5/27, 26.5/26, 25.5/25, 24.5/24, 23.5/23, 22.5/22mm

Code	Description	UOM	Price
<b>D0424</b>	Glass Dies for Tension Rings, Bergeon 5499.15	PACK*15	<b>£148.95</b>
<b>D28851</b>	Glass Dies for Tension Rings, Bergeon 5499.08	PACK*8	<b>£99.95</b>



Case Closing Presses & Pliers

See Page 1082



**5mm Lower Die Support, Bergeon 5500-T05**

Bergeon 5500-T05

- Dimensions
- Ø6mm Thread
  - Ø10mm Fitting
  - Raises die by 5mm

For Bergeon Glass fitting and Case Closing Tools:

- Bergeon 5500A (G0721)
- Bergeon 5500C (G0722)
- Bergeon 6173 (G0723)

(Requires reduction ring, code D38258)

Code	Description	UOM	Price
G19829	5mm Lower Die Support, Bergeon 5500-T05	EACH	£6.85



**PRESS & DIES, SWISS STYLE**

*Dies all interchangeable & compatible with*

- Bergeon Swiss
- Horotec Swiss
- Swiss Style

**Press & Die Set, Swiss Style**



- For fitting unbreakable crystals with or without tension ring
- On wooden stand
- Dimensions - 350 x 150mm

Item Includes:

- 1 press
- 1 Universal lower stake
- 2 Supports
- 14 Aluminium Bevelled Upper Reversible Dies Sizes (Diameter): Ø44/42, 41/40, 39/38, 37/36, 35/34, 33/32, 31/30, 29/28mm
- 10 Aluminium Flat Reversible Lower Dies. Sizes (Diameter): Ø12/10, 17/15, 19/18, 21/20, 23/22mm
- Ø25/24, 27/26, 29/28, 31/30, 33/32mm

Code	Description	UOM	Price
P38213	Glass Fitting Press & Dies	EACH	£149.95

**Case Closing Pliers**



- For closing snap on watch case backs or indeed watch glasses
- Rubber jaws to prevent scratching or marking
- Spring loaded
- Stainless steel
- Jaw diameter Ø40mm

• Overall length 200mm

Code	Description	UOM	Price
C39494	Watch Case Back Closing Pliers	EACH	£9.95

**Closing Press with Dies**



Case Back & Glass Fitting Press - Hand Held Lever - With Dies

For fitting flat mineral glasses and backs for quartz watch cases, with 12 nylon dies, in popular diameters.

- Die Diameters:
- Ø22 x 21mm, Ø25 x 24mm, Ø27 x 26mm
  - Ø28 x 27mm, Ø28 x 29mm, Ø31 x 30mm
  - Ø32 x 31mm, Ø33 x 32mm, Ø34 x 33mm
  - Ø36 x 35mm, Ø37 x 36mm, Ø40 x 39mm

Code	Description	UOM	Price
C6047	Closing Press with Dies	EACH	£10.25

**21mm Lower Die Support, Bergeon 5500-T21**

Bergeon 5500-T21

- Dimensions
- Ø6mm Thread
  - Ø10mm Fitting
  - Raises die by 21mm

For Bergeon Glass fitting and Case Closing Tools:

- Bergeon 5500A (G0721)
- Bergeon 5500C (G0722)
- Bergeon 6173 (G0723)

(Requires reduction ring, code D38258)

Code	Description	UOM	Price
G19830	21mm Lower Die Support, Bergeon 5500-T21	EACH	£6.85



**28mm Lower Die Support, Bergeon 5500-T28**

Bergeon 5500-T28

- Dimensions
- Ø6mm Thread
  - Ø10mm Fitting
  - Raises die by 28mm

For Bergeon Glass fitting and Case Closing Tools:

- Bergeon 5500A (G0721)
- Bergeon 5500C (G0722)
- Bergeon 6173 (G0723)

(Requires reduction ring, code D38258)

Code	Description	UOM	Price
G19831	28mm Lower Die Support, Bergeon 5500-T28	EACH	£6.85

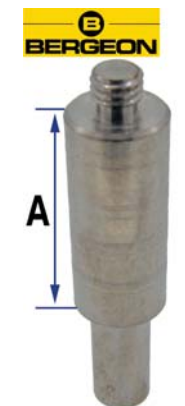

**XL Die Set for Lever Closing Press**



XL Dies for Press C6047

- Set of 6 extra large dies for C6047 case closing press
- Die sizes: 35, 40 & 45mm
- Double side dies 40/42.5mm, 45/47.5mm & 50/52.5mm
- Ideal for new larger type fashion watches

Code	Description	UOM	Price
C19023	XL Die Set for Lever Closing Press	PACK*8	£6.95

PRICE PROMISE GUARANTEE

**Universal Adapter for Screw on Dies**

See Page 1075



**TODAY** SAME DAY DISPATCH

**BROWSE & BUY**

**Square Die Set for Lever Closing Press**

**VALUE**



Square Die Set for Press C6047

- Set Of 4 Square Dies
- For Tool C6047
- Sizes 25, 32, 38 and 45mm

Code	Description	UOM	Price
C19733	Square Die Set for Lever Closing Press	PACK*4	£6.15

**Case & Glass Press, Heavy Duty**

**VALUE**



Case Back & Glass Fitting Press - Hand Held Lever - With Dies - Heavy Duty

For fitting flat mineral glasses and backs for quartz watch cases, with 24 nylon dies and spare black handle knob.

- Dies included:
- 10 Round: Ø21 to Ø60mm
  - 8 Round Flat: Ø24 to Ø52mm
  - 6 Square/Rectangular: 16 to 30mm (inside)
- Weight: 2.7Kg

Die set also available separately D37850

Code	Description	UOM	Price
C37835	Case & Glass Press, Heavy Duty	EACH	£27.95

**Die Set for Case & Glass Press, Heavy Duty**

**VALUE**



Die Set for Press C37835

- 10 Round: Ø21 to Ø60mm
- 8 Round Flat: Ø24 to Ø52mm

- 6 Square/Rectangular: 16 to 30mm (inside)

Code	Description	UOM	Price
D37850	Die Set for Case & Glass Press, Heavy Duty	PACK*24	£8.95

**Case Back Press**

**VALUE**

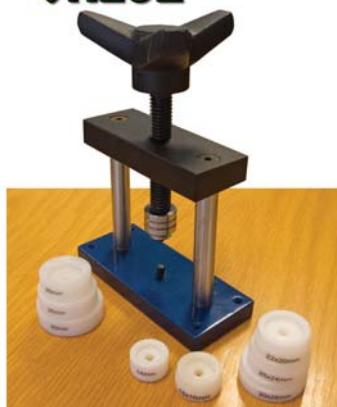

Case Back Closing Press - Single Stage - With Dies

- Ideal case closer for awkward snap on backs
- Base 120 x 50mm
- Quick and easy fitting of backs
- Heavy, sturdy construction
- Fantastic Value
- Threaded top pin, non threaded bottom pin
- 5 Threaded nylon dies included, sizes from Ø14 to Ø30mm
- 3 Non threaded nylon dies included, sizes Ø20, Ø25 & Ø30mm
- For extra dies see set D38224 & D38985

Code	Description	UOM	Price
C38223	Case Back Press	EACH	£19.95

**Die Set, Non Threaded**

**VALUE**



- 5 threaded dies, Ø14 to Ø30mm
- 3 Non threaded dies, Ø20, Ø25 & Ø30mm

Die set also available separately for tools C0311 & D38223

Code	Description	UOM	Price
D38985	Die Set, Non Threaded	PACK*8	£6.95

**Die Set, Threaded**

**VALUE**



- 8 Threaded nylon dies, from Ø14 to Ø30mm
- For tools C0311 & C38223

Die set also available separately for tools C0311 & D38223

Code	Description	UOM	Price
D38224	Die Set, Threaded	PACK*8	£1.50

**Case Back Press, Swiss Style**

**VALUE**



Case Back Closing Press - Single Stage - Superior

- Includes an even pressure spreading disc, providing a greater surface area meaning that pressure is exerted more evenly on the dies and case back
- Provides the same pressure as a standard size press in half the bench space
- Superior quality
- Supplied as per picture including 12 delrin dies, Ø18 to Ø50mm
- Easy to transport and carry
- Ideal case closer for awkward snap on backs
- Quick and easy fitting of case backs
- Smooth, matt, high quality finish
- For Screw fixing dies
- Base 95 x 80 x 10mm
- Made in China

Code	Description	UOM	Price
C41040	Case Back Press, Swiss Style	EACH	£75.95

**Pressure Disc for Case Back Tool**

**VALUE**



An even pressure spreading disc, providing a greater surface area meaning that pressure is exerted more evenly on the dies and case back

Code	Description	UOM	Price
C44146	Pressure Disc for Case Back Tool	EACH	£15.95

**Screw Closing Press, Compact**

**VALUE**



Case Back Closing Press - Single Stage - with Dies - Compact

- Ideal case closer for awkward snap on backs
- Base 80 x 60mm
- Quick and easy fitting of case backs
- Smooth, matt, high quality finish
- Rubber padded base
- Easy to transport and carry
- Great for small, tight working environments

- Fantastic value
- Non threaded bottom pin, top dies are push fit
- 12 delrin dies included
- Supplied with 6 cavity dies: Ø25, 30, 35, 37, 40 & 42mm
- Supplied with 6 flat dies: Ø25, 30, 35, 37, 40 & 42mm
- Made in far east

Code	Description	UOM	Price
C39642	Case Back Press, Compact	EACH	£12.25

**Set of Generic Dies**

**VALUE**



Case Back Closing Die Set - Generic - Set of 16

- Economy
- 16 nylon threaded dies sizes
- For tool C6047
- 6 flat dies: Ø20, 23, 25, 27, 30, & 35mm
- 10 double recessed dies (outer/inner size): Ø20.5/15.5, 23.5/ 21.5, 25.5/24.5, 27.5/26.5, 29/28, 31/30, 35/34, 39/37, 43/41 & 49/47mm (All sizes are approx)

Including metal die holder:

- Thread Ø6mm
- Base Ø12mm
- Overall length 30mm

Code	Description	UOM	Price
C20829	Case Back Closing Die Set	PACK*16	£11.95

**Die Set (Generic), Superior Quality**

**COUSINSUK**



Case Back Closing Die Set - Generic - Set of 24

- 17 round dies
- 6 square dies
- 1 base die
- Superior quality, made in Korea
- Supplied in sturdy storage and transportation case
- Can be used with any Horotec, A\*F or Bergeon Swiss threaded die press (Including Bergeon 5500)
- Can also be used with our code C38223

Round reversible dies:

- Ø18/20, Ø22/24, Ø26/28, Ø30/32mm
- Ø34/36, Ø38/40, Ø42/44, Ø46/48mm

Round dies:

- Ø16, Ø27, Ø32, Ø35, Ø39mm
- Ø50, Ø53, Ø56, Ø59mm

Rectangular dies:

- 23.8, 28.8, 33.8, 38.8, 43.8, 48.8mm

Code	Description	UOM	Price
D40365	Case Back & Glass Closing Die Set	PACK*24	£95.00

**SAME DAY DISPATCH**

**PRICE PROMISE GUARANTEE**

**PRESS & DIES, HOROTEC**

*Dies all interchangeable & compatible with*

- Bergeon Swiss
- Horotec Swiss
- Swiss Style

Screw on die sets:

- D44220 (Horotec 07.107): Assorted dies, extra large
- D44150 (Horotec 06.521): Bezel dies
- D44187 (Horotec 06.525): Bezel dies, extra large
- D44206 (Horotec 07.106): Case back dies
- D45412 (Horotec 07.108): Case back dies, extra large
- D44262 (Horotec 06.511A): Case back dies, pyramidal
- D44261 (Horotec 06.511B): Case back dies, pyramidal
- D44254 (Horotec 06.530): Case back dies, rectangular
- D44193 (Horotec 06.526): Glass, domed, extra deep dies
- D44143 (Horotec 06.520): Glass, flat mineral dies
- D44182 (Horotec 06.524): Glass, flat mineral dies, extra large
- D45556 (Horotec 06.520A): Glass, flat mineral with date bubble dies
- D44161 (Horotec 06.522): Glass with tension ring, dies
- D44176 (Horotec 06.523): Glass with tension ring, dies, extra large
- D45557 (Horotec 07.106U): Universal lower die

Push fit die sets:

- D44263 (Horotec 06.505): Bezel dies
- D44232 (Horotec 07.111): Case back dies, pack\*6, reduced set
- D45570 (Horotec 07.113): Case back dies, pack\*6, extra large
- D44233 (Horotec 07.116): Case back dies, pack\*13
- D44322 (Horotec 07.112): Glass, flat mineral dies, pack\*6
- D44221 (Horotec 06.510): Glass, flat mineral dies, pack\*10

**Rack Press (Screw on Dies)**



Horotec 06.150

This precision Rack-Press is provided with a small slide that allows to block or to free the toothed rack. The watchmaker thus has an exceptional tool for fitting glasses, bezels, closing watch cases and maintain the glass on the watch during joining time. Compatible with all Horotec screw-on dies

Free Toothed Rack (slide ahead)

For usual work on steel watch cases, thick or study. Apply pressure on the lever provided with an anti-skid

rubber. The return spring and the fixed handle allow for careful adjustment of pressure upon use.

Blocked Toothed Rack (slide behind)

For delicate work on gold cases, thin or delicate. Pull the slide to lock the toothed rack in the desired position, then with each rotation the die goes down about 1.5mm. The fitting precision can be perfectly controlled.

Dimensions:

- Screw on dies, 6mm thread
- 80 x 215 x 185mm
- 2.70Kg

Code	Description	UOM	Price
C44242	Rack Press (Screw on Dies)	EACH	£275.00

**Press (Screw On Dies) Compact**



Horotec 07.105

The Horotec compact press is equipped with a direct threaded broach. Supplied with an assortment of 9 reversible screw-on dies (07.106) used to close snap-on case backs. Compatible with all Horotec screw-on dies.

- Screw on dies, 6mm thread
- Anodised aluminium pillars for stability
- Universal lower die for cases with large case horns or bezel claws (D45557)
- Maximum tool capacity Ø50mm die
- Swiss Made

Dies included:

- Ø17, 19/21, 22/25, 26/29, 30/33, 34/37, 38/41 & 42/45mm
- Universal lower die Ø45mm (D45557)

Code	Description	UOM	Price
C44246	Press (Screw On Dies) Compact	EACH	£106.95

**Press (Screw On & Push Fit Dies)**



Horotec 07.131

A compact press, suitable for all Horotec dies, even



large diameters. The Horotec press is equipped with reversible die holders for fitting both screw-on & push fit dies. Supplied with an assortment of 12 reversible screw-on Delrin dies. Compatible with all Horotec screw-on and snap-on dies.

- Screw on dies, 6mm thread
- Snap-on upper dies Ø8mm fitting
- Snap-on lower dies Ø5mm fitting
- Universal lower die for cases with large case horns or bezel claws (D45557)
- Anodised aluminium pillars for stability
- Swiss Made

Dies included:

- Ø17, 19/21, 22/25, 26/29, 30/33, 34/37, 38/41, 42/45, 46/48, 49/50 & 52/55mm
- Universal lower die Ø45mm (D45557)

Dimensions:

- 110 x 95 x 210mm
- 1.2Kg

Code	Description	UOM	Price
C44240	Press (Screw On & Push Fit Dies)	EACH	£169.95

## Lower Die Adapter, Horotec 07.130.B



Horotec 07.130.B - Swiss Made

- for tool 07.131 (C44240)

Code	Description	UOM	Price
D47906	Lower Die Adapter, Horotec 07.130.B	EACH	£6.75

## Upper Die Adapter, Horotec 07.130.A



Horotec 07.130.A - Swiss Made

- for tool 07.131 (C44240)

Code	Description	UOM	Price
D47905	Upper Die Adapter, Horotec 07.130.A	EACH	£8.95

## Press (Push Fit Dies)



Horotec 07.110

The Horotec compact press is equipped with a direct threaded broach. Supplied with an assortment of 6 reversible snap-on dies (07.111) used to close snap-on case backs. Compatible with all Horotec snap-on dies.

- Snap-on upper dies Ø8mm fitting
- Snap-on lower dies Ø5mm fitting

- Maximum tool capacity Ø50 mm die.
- Anodised aluminium pillars for stability
- Swiss Made

Dies included:

- Upper dies: Ø20/23, 26/29, 32/35mm
- Lower dies: Ø29, 35, 40mm

Dimensions:

- 80 x 60 x 130mm
- 580g

Code	Description	UOM	Price
C4675	Press (Push Fit Dies)	EACH	£62.95

## Lower Die Support, Horotec 07.110A



Horotec 07.110-A - Swiss Made

- for tool 07.110 (C4675)

Code	Description	UOM	Price
D47903	Lower Die Support, Horotec 07.110A	EACH	£8.50

## Lower Die Support Gasket, Horotec 07.110.J



Horotec 07.110-J - Swiss Made

- for lower die support 07.110.A (D47903)

Code	Description	UOM	Price
D47904	Lower Die Support Gasket, Horotec 07.110.J	EACH	£0.95

## Assorted Dies (Screw On) Extra Large



Horotec 07.107

Set of 5, Special Large Diameters for Case Backs, Bezels & Flat Mineral Glasses. All dies compatible with all Horotec screw-on presses (plus also Bergeon & our Swiss Style Presses).

- Ø6mm thread
- Reinforced metal core to handle extreme pressure
- Delrin, strong non marking material
- Reversible dies

Set Contains

- 2 dies Ø40-45 & Ø46-50mm for fitting bezels
- 1 die Ø47-50mm for fitting flat mineral glasses
- 2 dies Ø46-48 & 49-50mm for fitting snap on case backs

Code	Description	UOM	Price
D44220	Assorted Dies (Screw On) Extra Large	PACK*5	£48.95

## Bezel Dies (Push Fit)

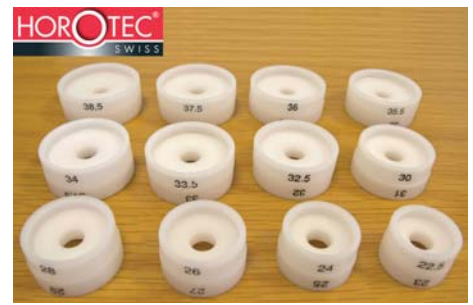

Horotec 06.505

Set of 12 varying diameters snap-on dies for fitting bezels. Compatible with all Horotec screw on die presses.

- Upper dies have Ø8mm fitting hole
- Delrin, strong non marking material
- Pack\*12
- Dies are reversible
- Horotec 06.505

Set Contains

- Ø23/22.5, 25/24, 27/26, 29/28, 31/30, 32.5/32, 33.5/33, 34.5/34, 35.5/35, 36.5/36, 37.5/37 & 38.5/38mm

Code	Description	UOM	Price
D44263	Bezel Dies (Push Fit)	PACK*12	£61.95
D44275	Ø23/22.5mm Die	EACH	£7.25
D44274	Ø25/24mm Die	EACH	£7.25
D44273	Ø27.5/26mm Die	EACH	£7.25
D44272	Ø29/28mm Die	EACH	£7.25
D44271	Ø31/30mm Die	EACH	£7.25
D44270	Ø32.5/32mm Die	EACH	£7.25
D44269	Ø33.5/33mm Die	EACH	£7.25
D44268	Ø34.5/34mm Die	EACH	£7.25
D44267	Ø35.5/35mm Die	EACH	£7.25
D44266	Ø36.5/36mm Die	EACH	£7.25
D44265	Ø37.5/37mm Die	EACH	£7.25
D44264	Ø38.5/38mm Die	EACH	£7.25

## Bezel Dies (Screw On)



Horotec 06.521 (set of 11)

Horotec 06.525 (set of 5) extra large

Set of 5 & 11, varying diameters including extra large dies for fitting watch bezels. All dies compatible with all Horotec screw-on presses (plus also Bergeon & our Swiss Style Presses).

- Ø6mm thread
- Reinforced metal core to handle extreme pressure
- Delrin, strong non marking material
- Reversible dies
- Universal lower die for cases with large case horns or bezel claws (D45557)

Set of 11 Contains

- Ø25/26, 27/28, 29/30, 31/32, 33/33.5, 34/34.5, 35/35.5, 36/36.5, 37/37.5 & 38/38.5mm
- Universal lower die Ø45mm (D45557)

Set of 5 Contains:

- Ø40/45, 46/50, 52/55, 57/60 & 62/65mm

Code	Description	UOM	Price
D44150	Bezel Dies (Screw On)	PACK*11	£76.95

D44187	Bezel Dies (Screw On) Extra Large	PACK*5	£53.80
D44151	Ø25/26mm Die	EACH	£11.95
D44152	Ø27/28mm Die	EACH	£11.95
D44153	Ø29/30mm Die	EACH	£11.95
D44154	Ø31/32mm Die	EACH	£11.95
D44155	Ø33/33.5mm Die	EACH	£11.95
D44156	Ø34/34.5mm Die	EACH	£11.95
D44157	Ø35/35.5mm Die	EACH	£11.95
D44158	Ø36/36.54mm Die	EACH	£11.95
D44159	Ø37/37.5mm Die	EACH	£11.95
D44160	Ø38/38.5mm Die	EACH	£11.95
D44188	Ø40/45mm Die	EACH	£11.95
D44189	Ø46/50mm Die	EACH	£13.75
D44190	Ø52/55mm Die	EACH	£14.50
D44191	Ø57/60mm Die	EACH	£14.50
D44192	Ø62/65mm Die	EACH	£14.50

**Case Back Dies (Push Fit)**



Horotec 07.111 (set of 6) reduced set  
 Horotec 07.113 (set of 6) extra large  
 Horotec 07.116 (set of 13)

Set of either 6 or 13 dies with varying diameters for snap-on case backs. Compatible with all Horotec snap-on presses.

- Upper die fitting Ø8mm
- Lower die fitting Ø5mm
- Delrin, strong non marking material
- Reversible upper dies

Set of 6 (reduced set) includes:  
 • Upper dies: Ø52/55, 57/60, 62/65mm  
 • Lower dies: Ø55, 60, 65mm

Set of 6 (extra large set) includes:  
 • Upper dies: Ø20/23, 26/29, 32/35mm  
 • Lower dies: Ø29, 35, 39mm

Set of 13 includes:  
 • Upper dies: Ø20/23, 26/29, 32/35, 36/38, 39/41, 42/44, 45/47, 48/50mm  
 • Lower dies: Ø29, 35, 40, 45 & 50mm

Code	Description	UOM	Price
D44232	Case Back Dies (Push Fit) Reduced Set	PACK*6	£33.95
D45570	Case Back Dies (Push Fit), Extra Large	PACK*6	£45.95
D44233	Case Back Dies (Push Fit)	PACK*13	£89.95
D44234	Lower Ø29mm Die	EACH	£4.95
D44235	Lower Ø35mm Die	EACH	£4.95
D44236	Lower Ø39mm Die	EACH	£4.95
D44237	Lower Ø40mm Die	EACH	£7.95
D44238	Lower Ø45mm Die	EACH	£7.95
D44239	Lower Ø50mm Die	EACH	£10.50
D44240	Lower Ø55mm Die	EACH	£11.25
D44241	Lower Ø60mm Die	EACH	£11.25
D44242	Lower Ø65mm Die	EACH	£11.25
D44243	Upper Ø20/23mm Die	EACH	£7.95
D44244	Upper Ø26/29mm Die	EACH	£7.95
D44245	Upper Ø32/35mm Die	EACH	£7.95
D44246	Upper Ø36/38mm Die	EACH	£7.95
D44247	Upper Ø39/41mm Die	EACH	£8.95
D44248	Upper Ø42/44mm Die	EACH	£8.95

D44249	Upper Ø45/47mm Die	EACH	£10.95
D44250	Upper Ø48/50mm Die	EACH	£10.95
D44251	Upper Ø52/55mm Die	EACH	£10.95
D44252	Upper Ø57/60mm Die	EACH	£10.95
D44253	Upper Ø62/65mm Die	EACH	£10.95

**Case Back Dies (Screw On)**



Horotec 07.106 (set of 9)  
 Horotec 07.108 (set of 5) extra large

Set of 5 or 9, varying diameters including extra large dies for snap-on case backs. All dies compatible with all Horotec screw-on presses (plus also Bergeon & our Swiss Style Presses).

- Ø6mm thread
- Reinforced metal core to handle extreme pressure
- Delrin, strong non marking material
- Reversible dies
- Universal lower die for cases with large case horns or bezel claws (D45557)

Set of 9 Contains:  
 • Ø17, 19/21, 22/25, 26/29, 30/33, 34/37, 38/41 & 42/45mm

• Universal lower die Ø45mm (D45557)

Set of 5 Contains:  
 • Ø46/48, 49/50, 52/55, 57/60 & 62/65mm

Code	Description	UOM	Price
D44206	Case Back Dies (Screw On)	PACK*9	£68.50
D45412	Case Back Dies (Screw On) Extra Large	PACK*5	£46.95
D44207	Ø17mm Die	EACH	£9.95
D44208	Ø19/21mm Die	EACH	£9.95
D44209	Ø22/25mm Die	EACH	£9.95
D44210	Ø26/29mm Die	EACH	£9.95
D44211	Ø30/33mm Die	EACH	£9.95
D44212	Ø34/37mm Die	EACH	£9.95
D44213	Ø38/41mm Die	EACH	£9.95
D44214	Ø42/45mm Die	EACH	£11.95
D44215	Ø46/48mm Die	EACH	£11.95
D44216	Ø49/50mm Die	EACH	£11.95
D44217	Ø52/55mm Die	EACH	£11.95
D44218	Ø57/60mm Die	EACH	£11.95
D44219	Ø62/65mm Die	EACH	£11.95

**Case Back Dies (Screw On) Pyramidal**



Horotec 06.511.A (gents/medium)  
 Horotec 06.511.B (ladies)

Two sizes of pyramidal dies. The die is placed on the base of the press and the watch glass comes above upside down to close the snap-on case back without damaging the pyramidal glass. All dies compatible with

all Horotec screw-on presses (plus also Bergeon & our Swiss Style Presses).

- Ø6mm thread
- Reinforced metal core to handle extreme pressure
- Delrin, strong non marking material

Dimensions:  
 • Gents/medium 45 x 37mm (Depth 11mm)  
 • Ladies 37 x 30mm (Depth 9mm)

Code	Description	UOM	Price
D44262	37 x 30mm Pyramidal Die, Ladies	EACH	£36.95
D44261	45 x 37mm Pyramidal Die, Gents/Medium	EACH	£36.95

**Case Back Dies (Screw On) Rectangular**



Horotec 06.530

Set of 6, varying size rectangular dies for fitting snap-on case backs or rectangular glasses. All dies compatible with all Horotec screw-on presses (plus also Bergeon & our Swiss Style Presses).

- Ø6mm thread
- Reinforced metal core to handle extreme pressure
- Delrin, strong non marking material

Dimensions: Length Ext. x Length Int. x (width x height)  
 • 24 x 13 x (13 x 13mm)  
 • 29 x 18 x (16 x 13mm)  
 • 34 x 23 x (19 x 13mm)  
 • 39 x 28 x (22 x 13mm)  
 • 44 x 33 x (25 x 13mm)  
 • 49 x 38 x (28 x 13mm)

Wall is 5.5mm thick with a 105 degree inner sloping chamfer

Code	Description	UOM	Price
D44254	Case Back Dies (Screw On) Rectangular	PACK*6	£33.50
D44255	24 x 13 x (13 x 13mm) Die	EACH	£8.95
D44256	29 x 18 x (16 x 13mm) Die	EACH	£8.95
D44257	34 x 23 x (19 x 13mm) Die	EACH	£8.95
D44258	39 x 28 x (22 x 13mm) Die	EACH	£8.95
D44259	44 x 33 x (25 x 13mm) Die	EACH	£8.95
D44260	49 x 38 x (28 x 13mm) Die	EACH	£8.95

**Glass Dies (Push Fit) for Flat Minerals**



Horotec 06.510 (set of 10)  
 Horotec 07.112 (set of 6)

Set of either 6 or 10 snap-on dies with varying diameters for fitting flat mineral glasses. Compatible with all Horotec snap-on presses.

- Upper die fitting Ø8mm
- Lower die fitting Ø5mm
- Delrin, strong non marking material
- Reversible dies

07.112 Set of 6 includes:  
 • Upper dies: Ø20/15, 30/25, 40/35mm

- Lower dies: Ø20/15, 30/25, 40/35mm

06.510 Set of 10 includes:

- Upper dies: Ø20/15, 22.5/17.5, 30/25, 32.5/27.5, 40/35mm
- Lower dies: Ø20/15, 22.5/17.5, 30/25, 32.5/27.5, 40/35mm

Code	Description	UOM	Price
D44221	Glass Dies (Push Fit) for Flat Minerals	PACK*10	£42.95
D44322	Glass Dies (Push Fit) for Flat Minerals, Reduced Set	PACK*6	£27.95
D44227	Lower Die Ø15/20mm	EACH	£6.50
D44228	Lower Die Ø17.5/22.5mm	EACH	£6.50
D44229	Lower Die Ø25/30mm	EACH	£6.50
D44230	Lower Die Ø27.5/32.5mm	EACH	£6.50
D44231	Lower Die Ø35/40mm	EACH	£6.50
D44222	Upper Die Ø15/20mm	EACH	£6.50
D44223	Upper Die Ø17.5/22.5mm	EACH	£6.50
D44224	Upper Die Ø25/30mm	EACH	£6.50
D44225	Upper Die Ø27.5/32.5mm	EACH	£6.50
D44226	Upper Die Ø35/40mm	EACH	£6.50

## Glass Dies (Screw On) for Flat Minerals



Horotec 06.520 (set of 8)

Horotec 06.524 (set of 4) extra large

Set of 4 or 8, varying diameters including extra large dies for fitting flat mineral watch glasses. All dies compatible with all Horotec screw-on presses (plus also Bergeon & our Swiss Style Presses).

- Ø6mm thread
- Reinforced metal core to handle extreme pressure
- Delrin, strong non marking material
- Reversible dies
- Universal lower die for cases with large case horns or bezel claws (D45557)

Set of 8 Contains:

- Ø16, 17/22, 23/28, 29/34, 35/40, 41/46mm
- Ø35mm die for glasses with date bubble
- Universal lower die Ø45mm (D45557)

Set of 4 Contains:

- Ø47/50, 52/55, 57/60 & 62/65mm

Code	Description	UOM	Price
D44143	Glass Dies (Screw On) for Flat Minerals	PACK*8	£63.50
D44182	Glass Dies (Screw On) for Flat Minerals, Extra Large	PACK*4	£41.95
D44144	Ø16mm Die	EACH	£8.95
D44145	Ø17/22mm Die	EACH	£8.95
D44146	Ø23/28mm Die	EACH	£8.95
D44147	Ø29/34mm Die	EACH	£8.95
D44148	Ø35/40mm Die	EACH	£8.95
D44149	Ø41/46mm Die	EACH	£8.95
D44183	Ø47/50mm Die	EACH	£12.95
D44184	Ø52/55mm Die	EACH	£12.95
D44185	Ø57/60mm Die	EACH	£12.95
D44186	Ø62/65mm Die	EACH	£12.95

## Glass Dies (Screw On) for Flat Minerals with Date Lens

Horotec 06.520-A

Individual die for fitting flat mineral watch glasses with a date bubble. All dies compatible with all Horotec screw-on presses (plus also Bergeon & our Swiss Style Presses).



- Ø6mm thread
- Reinforced metal core to handle extreme pressure
- Delrin, strong non marking material

Set Contains

- Ø35mm with cut out

Code	Description	UOM	Price
D45556	Glass Dies (Screw On) for Flat Minerals with Date Lens	EACH	£10.25

## Glass Dies (Screw On) for Domed, Extra Deep



Horotec 06.526

Set of 12, varying diameter dies for fitting very domed, deep watch glasses. All dies compatible with all Horotec screw-on presses (plus also Bergeon & our Swiss Style Presses).

- Ø6mm thread
- Reinforced metal core to handle extreme pressure
- Delrin, strong non marking material
- Extra deep, 14mm deep groove at a 45 degree angle

Set Contains

- Ø18, 20, 24, 28, 30, 35, 40, 45, 50, 55, 60 & 65mm

Code	Description	UOM	Price
D44193	Glass Dies (Screw On) for Domed, Extra Deep	PACK*12	£109.95
D44194	Ø18mm Die	EACH	£10.95
D44195	Ø20mm Die	EACH	£10.95
D44196	Ø24mm Die	EACH	£10.95
D44197	Ø28mm Die	EACH	£10.95
D44198	Ø30mm Die	EACH	£10.95
D44199	Ø35mm Die	EACH	£10.95
D44200	Ø40mm Die	EACH	£12.95
D44201	Ø45mm Die	EACH	£12.95
D44202	Ø50mm Die	EACH	£14.25
D44203	Ø55mm Die	EACH	£14.95
D44204	Ø60mm Die	EACH	£14.95
D44205	Ø65mm Die	EACH	£15.25

## Online Discounts

Rolex Oyster & Sea Dweller Case Back Opener

See Page 1064



## Glass Dies (Screw On) with Tension Rings



Horotec 06.522 (set of 15)

Horotec 06.523 (set of 5) extra large

Set of 15, varying diameters including extra large dies for fitting tension ring watch glasses. All dies compatible with all Horotec screw-on presses (plus also Bergeon & our Swiss Style Presses).

- Ø6mm thread
- Reinforced metal core to handle extreme pressure
- Delrin, strong non marking material
- Reversible dies
- Universal lower die for cases with large case horns or bezel claws (D45557)

Set of 15 Contains:

- Ø15, 16/17, 18/19, 20/21, 22/23, 24/25, 26/27, 28/29, 30/31, 32/33, 34/35, 36/37, 38/39, 40/41mm
- Universal lower die Ø45mm (D45557)

Set of 5 Contains:

- Ø42/45, 47/50, 52/55, 57/60 & 62/65mm

Code	Description	UOM	Price
D44161	Glass Dies (Screw On) with Tension Rings	PACK*15	£119.95
D44176	Glass Dies (Screw On) with Tension Rings, Extra Large	PACK*5	£39.95
D44162	Ø15mm Die	EACH	£9.25
D44163	Ø16/17mm Die	EACH	£9.25
D44164	Ø18/19mm Die	EACH	£9.25
D44165	Ø20/21mm Die	EACH	£9.25
D44166	Ø22/23mm Die	EACH	£9.25
D44167	Ø24/25mm Die	EACH	£9.25
D44168	Ø26/27mm Die	EACH	£9.25
D44169	Ø28/29mm Die	EACH	£9.25
D44170	Ø30/31mm Die	EACH	£9.25
D44171	Ø32/33mm Die	EACH	£9.25
D44172	Ø34/35mm Die	EACH	£9.25
D44173	Ø36/37mm Die	EACH	£9.25
D44174	Ø38/39mm Die	EACH	£9.25
D44175	Ø40/41mm Die	EACH	£9.25
D44177	Ø42/45mm Die	EACH	£9.95
D44178	Ø47/50mm Die	EACH	£9.95
D44179	Ø52/55mm Die	EACH	£9.95
D44180	Ø57/60mm Die	EACH	£9.95
D44181	Ø62/65mm Die	EACH	£9.95

## Universal Lower Die (Screw On) for Cases with Large Case Horns

Horotec 07.106-U

Individual universal lower die for cases with large case horns or bezel claws. All dies compatible with all Horotec screw-on presses (plus also Bergeon & our Swiss Style Presses).

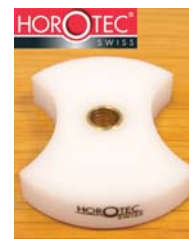

- Ø6mm thread
- Reinforced metal core to handle extreme pressure
- Delrin, strong non marking material

PRICE PROMISE GUARANTEE



Set Contains  
 • Ø45mm with cut out

Code	Description	UOM	Price
D45557	Universal Lower Die, Horotec Swiss	EACH	£11.95

**PRESS & DIES, ROBUR**

**Robur Case & Glass Press**



- Robur France
- Very Popular
- High Quality
- Frame with threaded vertical shaft
- For use with Die Set Robur T31 (D0425)

Code	Description	UOM	Price
G0728	Robur Case & Glass Press	EACH	£169.95

**Centre Shaft, Robur Press**



- For Robur Press G0728
- Includes Retaining Spring (D22160)

Code	Description	UOM	Price
G22246	Centre Shaft, Robur Press	EACH	£58.95

**Retaining Spring for the Upper Die Holder**

- For Robur Press G0728



Code	Description	UOM	Price
D22160	Retaining Spring for the Upper Die Holder	EACH	£9.60

**Case Closing Presses & Pliers**

See Page 1082



**Robur Comprehensive Die Set**



- Robur T31
- Very Popular
- High Quality
- Comprehensive size coverage
- 21 metal dies
- 10 acrylic dies
- Hinged wooden case
- Size: 220 x 325 x 45mm

Code	Description	UOM	Price
D0425	Robur Comprehensive Die Set	PACK*31	£269.95

**Dies Individual, Robur**

Robur Case & Glass Press Individual Dies

- Individual concave dies
- Acrylic / bakelite Dies
- Numbered with equivalent aluminium letter
- 'Self Hold' in Robur tool G0728



Glass Ø range for each die:

- A = Ø10.0 to Ø11.5mm
- B = Ø11.6 to Ø13.0mm
- C = Ø13.1 to Ø14.0mm
- D = Ø14.1 to Ø15.0mm
- E = Ø15.1 to Ø16.5mm
- F = Ø16.6 to Ø18.0mm
- G = Ø18.1 to Ø19.5mm
- H = Ø19.6 to Ø21.0mm
- K = Ø21.1 to Ø22.5mm
- L = Ø22.6 to Ø24.5mm
- M = Ø24.6 to Ø26.5mm
- N = Ø26.6 to Ø28.5mm
- O = Ø28.6 to Ø30.5mm
- P = Ø30.6 to Ø32.5mm
- R = Ø32.6 to Ø34.5mm
- S = Ø34.6 to Ø37.5mm
- T = Ø37.6 to Ø41.5mm
- U & V = Ø41.6 to Ø45.5mm
- X = Ø45.6 to Ø49.5mm
- No.9 = 19.5mm outside die diameter
- No.21 = 51mm outside die diameter
- No.22 = 53mm outside die diameter
- No.23 = 56mm outside die diameter

Code	Description	UOM	Price
D042501	No.1 (A) Robur Die	EACH	£20.95
D042502	No.2 (B) Robur Die	EACH	£20.95
D042503	No.3 (C) Robur Die	EACH	£20.95
D042504	No.4 (D) Robur Die	EACH	£20.95
D042505	No.5 (E) Robur Die	EACH	£20.95
D042506	No.6 (F) Robur Die	EACH	£20.95
D042507	No.7 (G) Robur Die	EACH	£20.95
D042508	No.8 (H) Robur Die	EACH	£20.95
D042509	No.9 Robur Die	EACH	£20.95
D042510	No.10 (K) Robur Die	EACH	£20.95
D042511	No.11 (L) Robur Die	EACH	£20.95
D042512	No.12 (M) Robur Die	EACH	£20.95
D042513	No.13 (N) Robur Die	EACH	£20.95
D042514	No.14 (O) Robur Die	EACH	£20.95
D042515	No.15 (P) Robur Die	EACH	£20.95
D042516	No.16 (R) Robur Die	EACH	£20.95
D042517	No.17 (S) Robur Die	EACH	£20.95
D042518	No.18 (U) Robur Die	EACH	£20.95
D042519	No.19 (V) Robur Die	EACH	£20.95

D042520	No.20 (X) Robur Die	EACH	£20.95
D042521	No.21 Robur Die	EACH	£20.95
D042522	No.22 Robur Die	EACH	£20.95
D042523	No.23 Robur Die	EACH	£20.95

**PRESS & DIES, STERNKREUZ**

**Dies Individual, Sternkreuz**



Specifically for Sternkreuz glass fitting tools

- Acrylic dies
- Base fitting Ø10mm

Code	Description	UOM	Price
D7198	No.OA (Ø6mm) Die	EACH	£5.95
D7199	No.14 (Ø14mm) Die	EACH	£1.95
D22965	No.18 (Ø18mm) Die	EACH	£1.95
D22966	No.19 (Ø19mm) Die	EACH	£1.95
D22967	No.20 (Ø20mm) Die	EACH	£1.95
D22287	No.22 (Ø22mm) Die	EACH	£1.95
D22288	No.25 (Ø25mm) Die	EACH	£1.95
D40219	No.26 (Ø26mm) Die	EACH	£1.95
D22302	No.33 (Ø33mm) Die	EACH	£1.95
D26022	No.38 (Ø38mm) Die	EACH	£1.95

**Digital Verniers**



See Page: 928

**Glass Gauge**

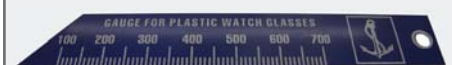

Ref: G39462 See Page: 928

**Watch Glass Adhesive**

See Page 1155

**WATCH CASE CUSHIONS**

Help stabilise your watch case while you work:

- Casing and uncasing of movements, making adjustments etc.
- For non scratching the crystal
- Snapping on case backs
- Tightening or loosening movement screws
- Standard, gel, synthetic or non slip
- With or without dust cover
- Bergeon Swiss, Horotec Swiss or unbranded

**Gel Cushions**

- Gel case cushions
- Soft, malleable material, leaving no marks
- Will not scratch parts
- Matches the shape of watch case of all shapes
- For casing and uncasing of movements, making adjustments etc.
- Non slip base
- Bergeon Swiss

For full specification see additional information

**Gel (Ø55mm) Cushion, Bergeon**



- Ø55mm
- Height 20mm
- Soft, malleable material, leaving no marks
- Will not scratch parts
- Matches the shape of watch case of all shapes
- For casing and uncasing of movements, making adjustments etc.
- Non slip base
- Bergeon 5395-55

Code	Description	UOM	Price
C40488	Gel (Ø55mm) Cushion, Bergeon	EACH	£20.95

**Dust Covers**

Ref: D6114  
See Page: 788



**Precision Press - 2 Stage, Horotec Swiss**

See Page 1081



**Gel (Ø75mm) Cushion, Bergeon**



- Ø75mm
- Height 20mm
- Soft, malleable material, leaving no marks
- Will not scratch parts
- Matches the shape of watch case of all shapes
- For casing and uncasing of movements, making adjustments etc.
- Non slip base
- Bergeon 5395-75

Code	Description	UOM	Price
C40489	Gel (Ø75mm) Cushion, Bergeon	EACH	£23.65

**Rubber Cushions**



- Ø90mm
- Height 16mm
- Anti scratch synthetic rubber polymer material
- Reversible
- One flat side with compartment for small parts
- One side with concave recess for cases with domed watch glasses
- Delivered with anti-dust lid
- Horotec 09.305
- Swiss made

Code	Description	UOM	Price
C44318	Ø90mm Cushion with Dust Cover	EACH	£27.95

PRICE PROMISE  
GUARANTEE



**Cleaning Swabs**

See Page 1167



**Padded Cushions**

- Padded
- Synthetic non-scratching material cover
- Non slip base
- Bergeon Swiss or unbranded

For full specification see additional information

**Padded (Ø50mm) Cushion**

**VALUE**



- Ø50mm
- Sunken central zone, padded top, felt base

Code	Description	UOM	Price
C7984	Padded (Ø50mm) Cushion	EACH	£3.75

**Padded (Ø50mm) Cushion, Bergeon**



- Ø50mm
- Height 13mm
- Felt hollow centre covered with synthetic non-scratching material
- For casing and uncasing of movements, making adjustments etc.
- Non slip base
- Weight 35g
- Bergeon 5394

Code	Description	UOM	Price
C0347	Padded (Ø50mm) Cushion, Bergeon	EACH	£23.95

**Padded (Ø75mm) Cushion**

**VALUE**



- Ø75mm
- 35g

Code	Description	UOM	Price
C31271	Padded (Ø75mm) Cushion	EACH	£4.40

## Silicone Cushions

- Silicone, non slip cushions
- Soft, non slip material, leaving no marks
- Wipe washable with soapy water
- Includes extra non slip silicon base
- Includes additional silicon cushion protector (C39291)
- Bergeon Swiss

For full specification see additional information

### Silicone (Ø55mm) Cushion, Bergeon



- Ø55mm
- Height 16mm
- Soft, non slip material, leaving no marks
- Wipe washable with soapy water
- Includes extra non slip silicon base
- Includes additional silicon cushion protector (C39291)
- Weight 50g
- Bergeon 5393-55

Code	Description	UOM	Price
C40487	Silicone (Ø55mm) Cushion, Bergeon	EACH	£46.95

### Silicone (Ø75mm) Cushion, Bergeon



- Ø75mm
- Height 16mm
- Soft, non slip material, leaving no marks
- Wipe washable with soapy water
- Includes extra non slip silicon base
- Includes additional silicon cushion protector (C39291)
- Weight 50g
- Bergeon 5393-75

Code	Description	UOM	Price
C39008	Silicone (Ø75mm) Cushion, Bergeon	EACH	£45.95

### Silicone Cushion Protector (Ø40mm), Bergeon



- Ø40mm diameter
- Use to protect casing cushion surface against indentation marks
- Extra protection for bezel claws, horns, bezels etc
- Bergeon 5393-P40

Code	Description	UOM	Price
C39291	Silicone Cushion Protector (Ø40mm), Bergeon	EACH	£3.45

## WATCH CASE HOLDING

Watchmakers and repairers use watch case holding tools to hold watches securely while opening them up for a variety of reasons, from battery changes and glass replacement to full on repairs or servicing.

- CousinsUK brings you a large variety of watch case holders, including watch holding vices with plastic posts which prevent marring
- Posts are removable and can be set into different positions for various size and shape cases
- Most open and close with large knurled knob
- Many of our holders have frames that can fit into bench vices, for extra immovability
- Also available are our case holders with watch strap post aids, holding in place a watch strap or bracelet keeping your view free and unobstructed as well as leaving both hands free for your work
- For something different why not try our wooden case holder, this has the added benefit that it can be used for extra delicate work, as softer wood will not mark or scratch a case
- Pocket watch display holders are also available, an elegant solution to display your own or indeed your customers' pocket watches

### Bench Top, A\*F Swiss



Case Holding Stands - A\*F Swiss

- Supports the watch while working on the case, movement or bracelet
- Sits on your work bench
- Soft, rubber inserts protects even the most delicate of items
- Easily work on all shaped cases
- Brilliant for watches with domed glasses
- Set of 3: Ø24, 30 & 40mm
- Base diameter Ø50mm
- Height 25mm
- Supplied in plastic storage and transport case
- Replacements available

Code	Description	UOM	Price
C40279	Watch Case Holder Set	PACK*3	£59.95
C40280	Ø24mm Case Holder	EACH	£18.95
C40281	Ø24mm Case Holder Insert	EACH	£3.95
C40282	Ø30mm Case Holder	EACH	£18.95
C40283	Ø30mm Case Holder Insert	EACH	£3.95
C40284	Ø40mm Case Holder	EACH	£18.95
C40285	Ø40mm Case Holder Insert	EACH	£3.95



**SAME DAY DISPATCH**

## Bench Top Case Holder, King size



A\*F Swiss - Case Holding Stand

- Solid case holder designed for holding today's modern large size watches
- Can hold cases of many shapes and sizes
- Can hold case from Ø20 to Ø60mm
- Two directional adjusting screws
- Interchangeable holding pins
- Rubber feet for maximum stability
- Rubber ring cushion to protect the watch glass and bezel
- Supplied with 4 white nylon jaws
- Black plastic jaws available for special shaped cases or cases with pushers

Code	Description	UOM	Price
C40286	Bench Top Case Holder, King size	EACH	£118.95

### Black Plastic Jaws for Case Holder



Code	Description	UOM	Price
C40288	Black Plastic Jaws for Case Holder	PACK*4	£29.95

### White Nylon Jaws for Case Holder



Code	Description	UOM	Price
C40287	White Nylon Jaws for Case Holder	PACK*4	£29.95

### Bench Vices

See Page 1047



### Case Back Closing Die Set

See Page 1081



**Bracelet & Case (Integrated)**

**VALUE**



Case Holding - Watches with Integrated Bracelets

Tool to handle watches with integrated bracelets allowing user to keep the bracelet open while working inside the case.

- Comes with reversible case holding die, Ø30mm or Ø35mm (Universal case dies code C20829)
- 125 x 60mm
- Weight: 260g
- Made in India

Code	Description	UOM	Price
C37140	Watch Case Holder, Indian	EACH	£7.95

**Bracelet & Case (Integrated), Horotec**



Case Holding - Watches with Integrated Bracelets - Horotec Swiss

Tool to handle watches with integrated bracelets allowing user to keep the bracelet open while working inside the case.

- Dimensions: 60 x 105 mm
- Weight: 260g

Code	Description	UOM	Price
C30554	Horotec MSA 10.007 Watch Case Holder	EACH	£33.95

**Clamp On, Indian**

**Ø50mm Capacity Case Holder, Clamp On**



Case Holding - Watch - With Table Clamp

- Ø50mm capacity
- Ideal to fix to work bench
- Portable, easy to move

- No need for a bench vice
- Provides extra stability
- Metal body
- Made in India

Dimensions:  
• 115 x 80mm  
• Weight: 250g

Code	Description	UOM	Price
M39632	Ø50mm Capacity Case Holder, Clamp On	EACH	£5.95

**Hand or Vice Held**

**Ø33mm Capacity, Metal Body**

- Up to Ø33mm
- 4 red plastic multi position pegs
- Metal body



Code	Description	UOM	Price
C35087	Ø33mm Capacity, Metal Body	EACH	£3.85

**Ø35mm Capacity, Metal Body**

- Held in bench vice
- Up to Ø35mm
- 4 white plastic multi position pegs
- Metal body
- For replacement pegs see P36116
- Size 55 x 45 x 25mm



Code	Description	UOM	Price
C5326	Ø35mm Capacity, Metal Body	EACH	£4.95

**Ø35mm Capacity, Metal Body - Crab**

- Hand held
- Up to Ø35mm
- 4 red plastic multi position pegs
- Metal body
- Size 80 x 70 x 30mm
- Crab Style



Code	Description	UOM	Price
C39414	Ø35mm Capacity, Metal Body - Crab	EACH	£8.95

**Ø45mm Capacity, Wooden Body**

- Ø45mm capacity
- Lightweight, non marking movement case holder
- Twin sided, precise machined holding compartments
- Easy action wing nut opening and closing method
- Carve or mill your own shape & design



Code	Description	UOM	Price
C36092	Ø45mm Capacity, Wooden Body	EACH	£3.95

**PRICE PROMISE GUARANTEE** ✓

**Ø55mm Capacity, Metal Body**

- Up to Ø55mm
- 4 red plastic multi-position pegs
- Metal body
- For positioning pegs see C36094



Code	Description	UOM	Price
C31293	Ø55mm Capacity, Metal Body	EACH	£6.85

**Jaw for C5326**

- Spare positioning pegs for C5326



Code	Description	UOM	Price
P36116	Jaw for C5326	PACK*4	£1.95

**Jaw for C31293**

- Spare positioning pegs for C31293



Code	Description	UOM	Price
C36094	Jaw for C31293	PACK*4	£1.95

**Hand or Vice Held, Bergeon**

**Ø35mm Capacity, Bergeon 5090**

- Small Model
- Held in bench vice
- Body of nylon
- Red plastic chucks
- Capacity max Ø35mm
- Size 45 x 35 x 65mm

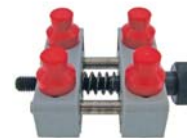

Code	Description	UOM	Price
C0303	Ø35mm Capacity, Bergeon 5090	EACH	£36.75

**Ø44mm Capacity, Bergeon 2820**

- Held in bench vice
- Body of steel
- Chucks in red plastic
- Capacity max Ø44mm



Code	Description	UOM	Price
C0306	Ø44mm Capacity, Bergeon 2820	EACH	£79.95

**Ø65mm Capacity, Bergeon 5685**

- Large model
- Can be fitted to bench vice
- Body of polyamide
- Red plastic jaws
- Capacity max Ø65mm
- Size 70 x 40 x 100mm



Code	Description	UOM	Price
C0304	Ø65mm Capacity, Bergeon 5685	EACH	£89.95

**Jaw for Bergeon 2820**

Replacement / Spare Jaw for Case Holding Tool  
• Bergeon 2820 (C0306)



Code	Description	UOM	Price
C21205	Jaw for Bergeon 2820	EACH	£2.45

**Jaw for Bergeon 5090A**

Replacement / Spare Jaw for Case Holding Tool  
• Bergeon 5090 (C0303)



Code	Description	UOM	Price
C22278	Jaw for Bergeon 5090A	EACH	£3.45

**Jaw for Bergeon 5685**

• Replacement Jaw for Case Holder 5685 (C0304)  
• Bergeon 5685A



Code	Description	UOM	Price
C0305	Jaw for Bergeon 5685	EACH	£4.50

**Screw Down with Base**

**VALUE**



Case Holding - Watch - With Base

- Ø60mm capacity
- Ideal to fix to work bench
- No need for a bench vice
- Provides extra stability
- Supplied with fixing screws
- Made in India

Dimensions:  
• 110 x 65mm  
• Weight: 750g

Code	Description	UOM	Price
C37837	Ø60mm Capacity Case Holder with Base	EACH	£11.95



**Unifix Case Vice**



Unifix Case Holder

- High quality, traditional case holder
- Sits in a bench vice
- Simply rotate platform to move case holding pins. It's knurled round the edge for extra grip
- Platform rotates left and right for extra quick case holding or release
- Height adjusting case platform, gives ease of access and preference of working height
- Case platform with rubber coating to protect the watch glass
- Plastic coated jaw holders, prevents damage to the watch case
- Sturdy stainless steel
- Made in Germany

C44196 Specifications:

- Holds cases from Ø28 to Ø45mm
- Ø20mm case platform width
- 4 x 15mm tall screw in jaws
- Ø80mm x 50mm (width x height)
- 650g

C44197 Specifications:

- Holds cases from Ø28 to Ø68mm (by changing the position of the jaws)
- Ø25mm case platform width
- 4 x 15mm tall screw in jaws
- 4 x 22mm tall screw in jaws
- Ø110mm x 70mm (width x height)
- 950g

Code	Description	UOM	Price
C44196	Ø22mm to Ø45mm Unifix Case Vice	EACH	£64.95
C44197	Ø28mm to Ø68mm Unifix Case Vice	EACH	£119.95

**WATCH CROWN REMOVING & WINDING TOOLS**

**Watch Crown Removing Tools**



Bergeon 4344.9 - "Presto" Tools

Removes:

- Hands
- Cannon pinions
- Sweep wheels
- Chronograph driving wheels
- Crown remover for split stems
- Also removes hands and setting knobs on travel alarm-clocks
- Yellow handle

Code	Description	UOM	Price
C0396	Crown & Split Stem Removing Tool	EACH	£32.95

**Crown Winder**



- Plunger opens and closes jaws
- Strong spring action holds button firm while winding
- Save wear and tear on fingers
- Ø4.5 to 6.0mm
- Made in India

Code	Description	UOM	Price
C37925	Crown Winder	EACH	£3.50

**Crown Winders, A\*F Swiss**



- A\*F Swiss 117.927
- Plunger opens and closes jaws
- Strong spring action holds button firm while winding
- Save wear and tear on fingers
- Ø3 to 5mm

Code	Description	UOM	Price
B7047	Ø3 to 5mm Watch Crown Winder	EACH	£20.50

**Crown Winders, Bergeon Swiss**



- Bergeon 30409A, B, C & D
- Plunger opens and closes jaws
- Strong spring action holds button firm while winding
- Save wear and tear on fingers
- To cover crown sizes 2 to 7mm

Code	Description	UOM	Price
B2271	Ø2 to 4mm, Bergeon 30409D	EACH	£24.50
B2268	Ø3 to 5mm, Bergeon 30409A	EACH	£24.50
B2270	Ø4 to 6mm, Bergeon 30409C	EACH	£24.50
B2269	Ø5 to 7mm, Bergeon 30409B	EACH	£24.50



**Digital Metal Verniers**

**See Page 928**

**Watch Crown Gauge**

**See Page 928**



# WATCH DIAL PROTECTORS & SUPPORTS

## Dial Protectors & Supports

Dial Protectors & Supports

- Protects the dial whilst removing hands
  - Ensures no scratches, marks or blemishes whilst watch is being worked on
  - Bergeon Swiss, Horotec Swiss or unbranded
- For specifications see additional information

### Plastic Dial Protectors, Bergeon Swiss



- Bergeon 6938
- 5 pieces
- Resistant synthetic material
- Soft non snap plastic
- Thickness 0.15mm
- Colour grey

Code	Description	UOM	Price
D19414	Plastic Dial Protectors, Bergeon Swiss	PACK*5	£3.25

### Plastic Dial Protectors, Horotec Swiss



- Horotec 70.004
- Pack\*10

Code	Description	UOM	Price
D46259	Plastic Dial Protectors, Horotec Swiss	PACK*10	£2.50

### Silicone Dial Protectors



- Pack\*5

• Silicone

Code	Description	UOM	Price
D44834	Silicone Dial Protectors	PACK*5	£5.75

### Vinyl Dial Protectors (Soft Plastic)



- Pack\*10
- Soft flexible plastic

Code	Description	UOM	Price
D45544	Vinyl Dial Protectors (Soft Plastic)	PACK*10	£1.50

### Dial Supports

- Bergeon 7153
- Many small holes allowing an easy and simple positioning of the dial feet
- Practical base for all types of Dial Plates.
- In synthetic Material
- Ø50mm
- 8mm Thick



Code	Description	UOM	Price
D32159	Dial Support, Bergeon Swiss	EACH	£42.95

# WATCH GLASS, DIAL & HAND CLEANING TOOLS

### Glass, Dial & Hand (Watch) Cleaning Pen, Bergeon Swiss



Watch Glass, Dial & Hand Cleaning Pen - Bergeon Swiss

- Ideal for cleaning watch glasses without touching or handling the case
- Great for cleaning watch dials without leaving any marks
- Can be used for watch hands
- Also brilliant for polishing precious stones
- Better than any polishing cloth or swab
- Light & easy to handle
- Also fitted with a dust off brush
- Supplied with round and concave tip (Cousins Ref G39004)
- Triangular & round flat tips available

• Bergeon 7971

Code	Description	UOM	Price
G39003	Glass & Dial Cleaning Pen, Bergeon Swiss	EACH	£16.95
G39004	Ø12mm Round & Concave	EACH	£8.95
G39006	Ø12mm Round & Flat Tip	EACH	£8.95
G39005	10 x 10 x 10mm Triangular Tip	EACH	£8.95

### Glass, Dial & Hand (Watch) Cleaning Pen, Cousins Swiss



Watch Glass, Dial & Hand Cleaning Pen - Cousins Swiss

- Made in Switzerland
- Ideal for cleaning watch glasses without touching or handling the case
- Great for cleaning watch dials without leaving any marks
- Can be used for watch hands
- Also brilliant for polishing precious stones
- Better than any polishing cloth or swab
- Light & easy to handle
- Also fitted with a dust off brush
- Supplied with round and concave tip (Cousins Ref G42449)
- Triangular & round flat tips available

Code	Description	UOM	Price
G42448	Glass & Dial Cleaning Pen, Cousins	EACH	£9.50
G42449	Ø12mm Round & Concave Tip	EACH	£3.95
G42450	Ø12mm Round & Flat Tip	EACH	£3.95
G42451	10x10 x 10mm Triangular Tip	EACH	£4.50

### Glass, Dial & Hand (Watch) Cleaning Pen - Mini, Bergeon Swiss



Watch Glass, Dial & Hand Cleaning Pen - Bergeon Swiss - Mini

- Designed specifically for watch hand cleaning
- Great for smaller more intricate glasses & dials
- Also brilliant for polishing precious stones
- Better than any polishing cloth or swab
- Light & easy to handle
- Also fitted with a dust off brush
- Supplied with round & flat tip (Cousins Ref G39671)
- Bergeon 7971- Mini

Dimensions:

- Overall length: 90mm
- Tip diameter: Ø5.5mm (approx)

Code	Description	UOM	Price
G39561	Glass, Dial & Hand Cleaning Pen	EACH	£16.85
G39671	Ø5mm Round & Flat Tip	EACH	£9.85

**Cleaning Pen**

**Online Tutorials**

**Glass, Dial & Hand (Watch) Cleaning Pen - Mini, Cousins Swiss**



Watch Glass, Dial & Hand Cleaning Pen - Cousins - Mini

- Made in Switzerland
- Designed specifically for watch hand cleaning
- Great for smaller more intricate glasses & dials
- Also brilliant for polishing precious stones
- Better than any polishing cloth or swab
- Light & easy to handle
- Also fitted with a dust off brush
- Supplied with round & flat tip (Cousins Ref G42453)

Dimensions:

- Overall length: 90mm
- Tip diameter: Ø5.5mm (approx)

Code	Description	UOM	Price
G42452	Glass, Dial & Hand Cleaning Pen	EACH	£9.50
G42453	Ø5mm Round & Flat Tip	EACH	£5.75

- Ø0.40, 0.45, 0.50, 0.55, 0.60, 0.70, 1.10, 1.20, 1.30, 1.40, 1.50, 1.60, 1.70, 1.80, 2.00, 2.20, 2.40 & 2.60mm

Code	Description	UOM	Price
C43689	Hand & Crown Pipe & Case Tube Tightening Tool	EACH	£419.95

**HAND (WATCH) FITTING PRESSES**

**Hand Fitting Multi Press (Watch), Non Swiss**



Watch Hand Fitting - Fitting Press

- High precision hand fitting tool
- 3 posts make for quick, easy and accurate hand fitting
- Post height is adjustable
- Spring loaded press action
- Rotating stand
- Supplied with 3 dies for movement support
- Overall height 175mm

Tips:

- Ø1.50mm
- Ø1.00mm
- Ø0.60mm

Code	Description	UOM	Price
H47057	Hand Fitting Press	EACH	£55.95

**Hand Fitting Multi Press (Watch), Bergeon Swiss**



- High precision hand setting tool
- Enhanced guidance of the hand presses

- Excellent for intricate & delicate work
- 4 different stakes
- Holding base of Ø31mm
- Overall height 180mm
- Synthetic press tips ensures no scratching or marking
- Bergeon 8935
- Spare press tips available
- Ø2.60mm tip also available separately, this tip can be adjusted/sculpted to suit your need
- Intermediate plates are to be used with movement holders with hand setting pivots
- Additional press H44214, limits the force that can be exerted on hands. Force limiter adjustable from 5 Newtons to 40 Newtons

Tip sizes (External x Internal):

- Ø2.60 x 1.60mm (Yellow)
- Ø2.10 x 1.20mm (Red)
- Ø1.70 x 0.60mm (Grey)
- Ø1.50mm (Blue)

Intermediate Plates:

- Ø3.25mm Pivot
- Ø5.00mm Pivot

Code	Description	UOM	Price
H40483	Hand Fitting Press, Bergeon Swiss	EACH	£725.00
H44214	Runner with Torque (Measured Force)	EACH	£295.00
H40526	Ø1.50mm (Blue) Press Tip	EACH	£13.25
H40524	Ø1.70 x 0.60mm (Grey) Press Tip	EACH	£13.25
H40523	Ø2.10 x 1.20mm (Red) Press Tip	EACH	£13.25
H40522	Ø2.60 x 1.60mm (Yellow) Press Tip	EACH	£13.25
H40525	Ø2.60mm Press Tip (for bespoke)	EACH	£13.25
H43060	Ø3.25mm Pivot Intermediate Plate	EACH	£59.95
H43061	Ø5.00mm Pivot Intermediate Plate	EACH	£64.95

**Hand Fitting Press (Watch)**



Watch Hand Fitting - Fitting Press

- Watch Hand Fitting Press
- 7 different hole diameters included
- Spring loaded press action
- Stainless steel construction
- Much sturdier & easier to use than other versions on the market
- Value item
- Made in India

Dimensions:

- 65 x 80 x 150mm
- 365g

Code	Description	UOM	Price
H37126	Hand Fitting Press	EACH	£14.75
H37761	Hand Fitting Stakes	PACK*7	£4.95

**WATCH HAND REMOVING AND FITTING**

**HAND (WATCH) COLLET TIGHTENING TOOL**

**Hand Collet Tightening Tool**



Bergeon 3010 - Swiss Made

- Ensures that the pipe/collet is tightened evenly across it's entire circumference, ensuring a firm and even fit
- For watch hands, crowns and case tubes
- 18 interchangeable collets
- Supplied in stylish black wooden box

Collet sizes:



## Hand Fitting Press (Watch), Horotec Swiss



Watch Hand Fitting - Fitting Press - Horotec Swiss

Hand fitting press for wrist and pocket watches. Allows for a quick, efficient and exact job. This tool gives precise control by holding the die vertically while pressing the hand onto the dial

- Watch Hand Fitting Press
- 8 different delrin stakes included
- Spring loaded press action
- Precise action
- Horotec 05.021

Dimensions:  
• 60 x 50 x 105mm  
• 220g

Code	Description	UOM	Price
H41119	Hand Fitting Press, Horotec Swiss	EACH	£49.95
H41120	Ø0.50mm Stake	EACH	£4.95
H41121	Ø0.70mm Stake	EACH	£4.95
H41122	Ø0.90mm Stake	EACH	£4.95
H41123	Ø1.20mm Stake	EACH	£4.95
H41124	Ø1.50mm Stake	EACH	£4.95
H41125	Ø1.70mm Stake	EACH	£4.95
H41127	Conical Stake	EACH	£4.95
H41126	Flat Stake	EACH	£4.95

## Hand Fitting Press (Watch), Horotec Swiss 3 Press

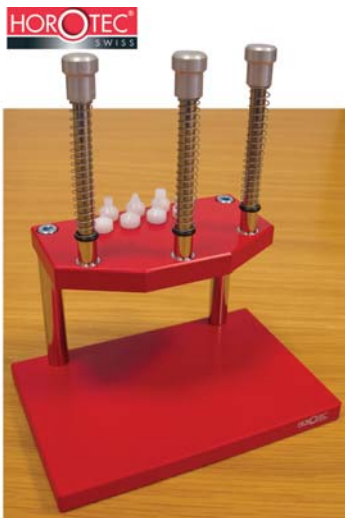

Horotec 05.022 - Swiss Made

Hand fitting press for wrist and pocket watches. Allows for a quick, efficient and exact job. This tool gives precise control by holding the die vertically while pressing the hand onto the dial

- Watch Hand Fitting Press
- With 3 presses, no need for constant die changing
- 8 different delrin stakes included
- Spring loaded press action
- Precise action
- For replacement stakes see from code H41120

Dimensions:  
• 94 x 50 x 115mm  
• 315g

Code	Description	UOM	Price
H44238	Hand Fitting Press, Horotec Swiss	EACH	£84.95

## HAND (WATCH) FITTING TOOLS

### Hand Fitting (Watch)

#### Hand Fitting Tool Set



- Set of 3 tools
- 90mm overall length
- Tool (blue/gold): Flat/0.80mm
- Tool (black/white): 1.00/0.50mm
- Tool (grey/red): 1.50/1.80mm
- Value item
- Knurled handles
- Brass bodies

Code	Description	UOM	Price
H37241	Hand Fitting Tool Set	PACK*3	£5.95

#### Hand Fitting Tool Set, Extra Long

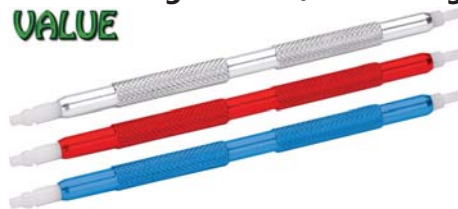

- Set of 3 tools
- 140mm overall length
- Grey tool: 0.50 /1.00mm
- Red tool: 0.80/Flat 3.50mm
- Blue tool: 1.50/2.00mm
- Value item
- Knurled handles
- Lightweight aluminium

Code	Description	UOM	Price
H41169	Hand Fitting Tool Set, Extra Long	PACK*3	£6.50

#### Hand Fitting Tool, with Fibreglass Tips



- Fibreglass tips
- Hole size Ø0.50 & 1.00mm
- 95mm long
- Brass body
- Knurled handle

Code	Description	UOM	Price
H47059	Hand Fitting Tool, with Fibreglass Tips	EACH	£1.95

## Hand Fitting Pressers

VALUE



- Set of 3 pressers
- Supplied in pouch
- For fitting hands without scratching the dial

Code	Description	UOM	Price
H47058	Hand Fitting Pressers	PACK*3	£3.95

## Hand Fitting (Watch), A\*F Swiss



A\*F Swiss

In plated brass, length 105mm, body diameter 6mm with two replaceable tips in nylon. Hole diameters 0.50mm & 1.00mm.

- Plated brass
- Body Ø6mm
- Two pierced end pieces
- Tips: 0.50 & 1.00mm
- Length 105 mm

Code	Description	UOM	Price
H7350	Ø0.50 & Ø1.00mm Tool	EACH	£9.95
H48027	Ø0.50mm Tip	EACH	£2.25
H48028	Ø1.00mm Tip	EACH	£2.25

## Hand Fitting (Watch), A\*F Swiss, Elegance



A\*F 174.316 Swiss Made

Make hand fitting easy, with maximum control and accuracy. Thanks to their plastic ends, these tools are ideal to insert watch hands without scratching the dial. Two different hole diameters per tool available to ensure a perfect fit.

Aluminium handles in attractive blue anodised finish. Spare tips available.

Individual or Set of 3 tools:

- Ø0.50 & Ø1.00mm (white & black)
- Ø0.80mm & Concave (red & blue)
- Ø1.50mm & Flat (grey & brass)
- Swiss made

Code	Description	UOM	Price
H31401	Set of 3, A*F Swiss, Elegance	PACK*3	£28.95
H48019	Single Ø0.50 & Ø1.00mm (white & black)	EACH	£9.95
H48018	Single Ø0.80mm & Concave (red & blue)	EACH	£9.95
H48020	Single Ø1.50mm & Flat (grey & brass)	EACH	£9.95
H48025	Tip Ø0.50mm (White)	EACH	£2.45
H48023	Tip Ø0.80mm (Red)	EACH	£2.45
H48024	Tip Ø1.00mm (Black)	EACH	£2.45
H48026	Tip Ø1.50mm (Grey)	EACH	£2.45
H48021	Tip, Concave (Blue)	EACH	£2.45
H48022	Tip, Flat (Brass)	EACH	£2.45

Wrist & Pocket Watch Hands  
See Page 214

**Hand Fitting (Watch), Bergeon Swiss**



Bergeon 7404 - Swiss Made

Make hand fitting easy, with maximum control and accuracy.

- Set of 3 tools, with or without base
- Individuals available separately
- Length 115mm
- Diameter Ø6mm
- Knurled handles

Sets contain:

- Bergeon 7404.1 (Grey Handle) Ø0.50 & Ø1.00mm
- Bergeon 7404.2 (Black Handle) Ø0.80 & Ø1.50mm
- Bergeon 7404.3 (Red Handle) Flat brass & Concave blue for centre positioning

Code	Description	UOM	Price
H40485	Set of 3 with Base, Bergeon 7404.S03	PACK*3	£53.50
H20057	Set of 3 in Box, Bergeon 7404	PACK*3	£36.50
H0773	Single Ø0.50 & Ø1.00mm (white & black)	EACH	£11.95
H46470	Single Ø0.80 & Ø1.50mm (red & grey)	EACH	£11.95
H46471	Single Flat & Concave (Brass & Blue)	EACH	£11.95
H48041	Tip Ø0.50mm (White)	EACH	£2.45
H48042	Tip Ø0.80mm (Red)	EACH	£2.45
H48043	Tip Ø1.00mm (Black)	EACH	£2.45
H48044	Tip Ø1.50mm (Grey)	EACH	£2.45
H48045	Tip, Concave (Blue)	EACH	£2.45
H48046	Tip, Flat (Brass)	EACH	£2.45

**Hand Fitting (Watch), Bergeon Swiss Ergonomic**



Bergeon 8404-S04 - Swiss Made - Ergonomic

Make hand fitting easy, with maximum control and accuracy.

- Set of 4
- Knurled handles
- With rotating heads for an easy indexing of the hands
- Tips in synthetic material
- Supplied with smart & handy base
- Colour coded
- For spare tips see from our code H40526

Sizes:

- Grey: Ø0.60mm hole
- Red: Ø1.52mm hole
- Yellow: Ø1.60mm hole
- Blue: Ø1.50mm Flat

Code	Description	UOM	Price
H40484	Bergeon Hand Fitting Tool, Pack*4 & Base	PACK*4	£128.95

**Hand Fitting (Watch), Horotec Swiss**



Horotec Swiss - Delrin Tips

Make hand fitting easy, with maximum control and accuracy. Thanks to their plastic ends, these tools are ideal to insert watch hands without scratching the dial. Two different hole diameters per tool available to ensure a perfect fit..

Aluminium handles in attractive red anodised finish. Spare tips available.

Individual or Set of 4 tools:

- Flat (without hole) & Ø0.80mm (blue & yellow)
- Ø0.50 & Ø1.00mm (white & black)
- Ø0.65 & Ø1.10mm (blue & black)
- Ø1.50 & Ø2.00mm (black & red)
- Swiss made

Code	Description	UOM	Price
H48029	Set of 4, Horotec Swiss	PACK*4	£34.65
H48030	Single Flat (without hole) & Ø0.80mm (blue & yellow)	EACH	£9.25
H48033	Single Ø0.50 & Ø1.00mm (white & black)	EACH	£9.25
H48036	Single Ø0.65 & Ø1.10mm (blue & black)	EACH	£12.25
H19819	Single Ø1.50 & Ø2.00mm (black & red)	EACH	£9.50
H48031	Tip, Flat (Blue)	EACH	£1.80
H48034	Tip Ø0.50mm (White)	EACH	£1.80
H48037	Tip Ø0.65mm (Blue)	EACH	£4.75
H48032	Tip Ø0.80mm (Yellow)	EACH	£1.80
H48035	Tip Ø1.00mm (Black)	EACH	£1.80
H48038	Tip Ø1.10mm (Black)	EACH	£3.95
H48039	Tip Ø1.50mm (Black)	EACH	£4.75
H48040	Tip Ø2.00mm (Red)	EACH	£4.75

**Hand Fitting (Watch) Stakes & Base**

- Set of 9 presses & handle
- 9 different sizes: Flat x 2, Ø0.80, 0.90, 1.00, 1.10, 1.20, 1.30, 1.50mm
- Value item
- Plastic handle
- Stainless steel base
- Made in India



Code	Description	UOM	Price
H39644	Hand Fitting Tool	EACH	£7.95

**Watch Hand Gauge**

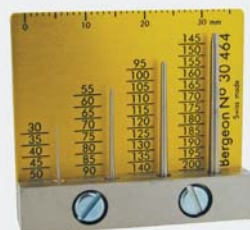

Ref: G0698  
See Page: 929

**Hand Fitting (Watch) Stakes & Base, Bergeon Swiss**

Bergeon 5378 - Swiss Made

- With 8 stakes and holder spindle on nickel base
- Diameter 50 mm
- Stake sizes: Ø0.30, 0.50, 0.70, 1.15, 1.50 and 1.70mm



Code	Description	UOM	Price
H0774	Bergeon Hand Fitting Tool, 8 Stakes & Base	EACH	£51.95

**Hand Fitting & Movement Holder**

Bergeon 5409 - Swiss Made

The plate is engraved with circles to facilitate centring the movement on the rest rod. This plate is sustained by a spring and adjusts to the required height automatically.



- Universal movement holder and hand fitting

Code	Description	UOM	Price
M0985	Hand Fitting & Movement Holder	EACH	£74.95

**HAND (WATCH) HOLDING TOOLS**

**Hand Holding (Watch)**

Watch Hand Holding

A selection of watch hand holding tools used to hold watch hands while broaching, drilling the holes or filing hands shorter. Spring loaded for quick release and holding, steel construction and polished finished with a knurled handle and 10 holes.

Perfect for holding onto hands or other small parts.

**Watch Hand Holding Tool, Indian VALUE**

An Indian made watch hand holding tool excellently made and at an economy price useful for general purpose main stream watches.

- Indian



Code	Description	UOM	Price
H34932	Watch Hand Holding Tool, Indian	EACH	£6.50

PRICE PROMISE GUARANTEE

## Watch Hand Holding Tool, Bergeon



Bergeon 2676 - Swiss Made

The original Bergeon Swiss hand holding tool is extreme high quality perfect for the high end branded watch hand making

Code	Description	UOM	Price
H0775	Watch Hand Holding Tool, Bergeon	EACH	£51.50

## Watch Hand Holding Tweezers, Bergeon



The watch hand holding tweezers are handy little devices quickly holding your watch hands to work on and perfect for broaching.

- Bergeon 30004
- Pair of brass tweezers for holding hands while broaching, filing etc.
- In nickel-plated brass

Code	Description	UOM	Price
T1793	Watch Hand Holding Tweezers, Bergeon	EACH	£39.95

## HAND (WATCH) REMOVING LEVERS

## Hand Removing & Hairspring Levers, Bergeon Swiss



Bergeon 30020 - Swiss Made

The top quality collection of hand held levers for removing watch and clock hands, plus for turning & setting & reaming watch hairspring Collets.

- Assortment of Levers
- Wooden Case
- Avoid potential damage
- Bergeon Swiss

Contents:

- For turning & setting hairspring collets
- Bergeon 30019-P: Hole Ø0.45mm x Exterior Ø1.20mm
- Bergeon 30017-G: Hole Ø0.70mm x Exterior Ø1.80mm

Broaches for hairspring collets

- Bergeon 30015-P: Ø0.40 to Ø0.90mm
- Bergeon 30015-G: Ø0.70 to Ø1.25mm

Pairs of levers for hairspring collets

- Bergeon 30013: width 1.70mm, length 105mm
- Bergeon 30014: width 2.50mm, length 105mm

Pairs of levers for hands

- Bergeon 30011: width 7mm, length 105mm
- Bergeon 30012: width 9mm, length 105mm

Code	Description	UOM	Price
H0779	Assortment of Levers, Bergeon 30020	PACK*12	£265.00

## Hand Removing Levers, Bergeon Swiss

Bergeon Swiss Made

The hardened steel specular polish work surfaces with perfectly formed notches make it easier the positioning for the quick and easy removal of watch hands. Ideal for use in conjunction with our dial protectors.

## 2.5mm Wide, Bergeon 30018-1 by Petitpierre



Bergeon 30018-1 - Swiss Made

Front part in hardened steel with notch to make easier the positioning. Mirror finished tips with anodized aluminum handles.

- Tip width: 2.5mm
- Tip edge thickness: 0.15mm
- Lever's angle 70°
- Length: 105mm
- Weight 7g

Code	Description	UOM	Price
L19456	2.5mm Wide, Bergeon 30018-1 by Petitpierre	PAIR	£109.95

## 2.5mm Wide, Bergeon 30019



Bergeon 30019 - Swiss Made

In hardened steel with notch to make easier the positioning. Mirror finished tips with knurled handles.

- Tip width: 2.5mm
- Tip edge thickness: 0.20mm
- Length: 110mm
- Weight 16gm

Code	Description	UOM	Price
H46467	2.5mm Wide, Bergeon 30019	PAIR	£42.95

## 3mm Wide, Bergeon 5431



Bergeon 5431 - Swiss Made

Hardened steel mirror finished tips with black plastic handles.

- Tip width: 3mm
- Length: 90mm
- Weight 13gm

Code	Description	UOM	Price
H0776	3mm Wide, Bergeon 5431	PAIR	£37.95



Online Discounts

## 7mm Wide, Bergeon 30011



Bergeon 30011 - Swiss Made

In hardened steel with notch to make easier the positioning. Mirror finished tips with knurled handles.

- Tip width: 7mm
- Length: 105mm
- Weight 22gm

Code	Description	UOM	Price
H0777	7mm Wide, Bergeon 30011	PAIR	£55.95

## 9mm Wide, Bergeon 30012



Bergeon 30012 - Swiss Made

In hardened steel with notch to make easier the positioning. Mirror finished tips with knurled handles.

- Tip width: 9mm
- Length: 105mm
- Weight 24gm

Code	Description	UOM	Price
H0778	9mm Wide, Bergeon 30012	PAIR	£59.95

## Hand Removing Levers, Horotec Swiss

Horotec - Swiss Made

- 05.009 (1mm) for sweep seconds and small subsidiary hands
- 05.007 (2.5mm) for wrist watches
- 05.008 (4mm) for pocket watches
- 05.014 (10mm) for alarm and wall clocks

Hand levers (pairs) with varnished aluminium handles. Ideal for use in conjunction with our dial protectors.

- Avoid potential damage
- With Varnished Aluminium Handles
- Various tip widths
- Lengths 105 & 115mm

## 1mm Wide, Horotec 05.009



Horotec 05.009 - Swiss Made

Pair of hand levers with varnished aluminium handles for sweep seconds hands and small counter hands of chronometers. Delivered with 2 dial protectors Horotec 70.004.

- Avoid potential damage
- For Sweep Second and Small Counter Hands for Chronometers
- With Varnished Aluminium Handles
- Tip width 1mm
- Length 105mm

Code	Description	UOM	Price
H32670	1mm Wide, Horotec 05.009	PAIR	£14.35



OVER 7000 PDF DOWNLOADS

**2.5mm Wide, Horotec 05.007**



Horotec 05.007 - Swiss Made  
Pair of hand levers with varnished aluminium handles for wrist watches. Delivered with 2 dial protectors Horotec 70.004.

- Avoid potential damage
- For wrist watches
- With Varnished Aluminium Handles
- Tip width 2.5mm
- Length 105mm

Code	Description	UOM	Price
H48219	2.5mm Wide, Horotec 05.007	PAIR	£18.75

**4mm Wide, Horotec 05.008**



Horotec 05.008 - Swiss Made  
Pair of hand levers with varnished aluminium handles for pocket watches. Delivered with 2 dial protectors Horotec 70.004.

- Avoid potential damage
- For pocket watches
- With Varnished Aluminium Handles
- Tip width 4mm
- Length 105mm

Code	Description	UOM	Price
H48220	4mm Wide, Horotec 05.008	PAIR	£18.75

**10mm Wide, Horotec 05.014**



Horotec 05.014 - Swiss Made  
Pair of hand levers with varnished aluminium handles for alarm & wall clocks. Delivered with 2 dial protectors Horotec 70.004.

- Avoid potential damage
- For pocket watches
- With Varnished Aluminium Handles
- Tip width 10mm
- Length 115mm

Code	Description	UOM	Price
H48221	10mm Wide, Horotec 05.014	PAIR	£43.95

**Hand Removing Levers, Non Swiss**



Watch Hand Removing Levers  
For the quick and easy removal of watch hands. Ideal for use in conjunction with our dial protectors.

- Lever action
- Avoid potential damage
- Made India

Code	Description	UOM	Price
H39643	Indian, 2.5mm Width	PAIR	£2.25



**HAND (WATCH) REMOVING TOOLS**

**Hand Removing Tools (Watch), Bergeon**



Watch Hand Removing - Bergeon Swiss  
Bergeon PRESTO hand removers for wrist watches equipped with buffer to avoid damaging the dial.

- Wrist watch hand removers
- Cannon pinion removers
- Pocket watch hand removers
- Multi-spoke hand removers
- Second hand removers
- Non dial touch removers
- Alarm clocks & Timers

**Bergeon 30636.1, Watch Hands**



Bergeon 30636.1 - "Presto" Tools

- Hand remover for wrist watches
- Tips will not damage the dial
- Black handle

Code	Description	UOM	Price
H0784	Bergeon 30636.1, Watch Hands	EACH	£27.95

**Bergeon 30637.2, Cannon Pinions & Pocket Watch Hands**



Bergeon 30637.2 - "Presto" Tools

- For removing cannon pinions and hands of large watches
- Stronger
- Green handle

Code	Description	UOM	Price
H0783	Bergeon 30637.2, Cannon Pinions & Pocket Watch Hands	EACH	£35.95

**Wrist & Pocket Watch Hands**  
See Page 214

**Bergeon 30669.4, Alarm Clocks & Timers**



Bergeon 30669.4 - "Presto" Tools

- For alarm clocks, timers and other instruments
- Strong tool with different spokes diam. 0.70 - 0.90 - 1.20 - 1.40 mm
- Violet handle

Code	Description	UOM	Price
H0782	Bergeon 30669.4, Alarm Clocks & Timers	EACH	£38.95

**Bergeon 30670.6, Watch Seconds Hands**



Bergeon 30670.6 - "Presto" Tools

- Second hand remover
- Excellent for curved countersink dials
- White handle

Code	Description	UOM	Price
H0786	Bergeon 30670.6, Watch Seconds Hands	EACH	£33.50

**Bergeon 30671.7, Watch hands, No Touch**



Bergeon 30671.7 - "Presto" Tools

- Hand remover that removes hands without touching the dial
- For curved dials, stop watches & movements without dials
- Points: Ø0.20 - 0.65 - 0.90 - 1.15 mm

Code	Description	UOM	Price
H0785	Bergeon 30671.7, Watch hands, No Touch	EACH	£42.95

**Hand Removing Tools (Watch), Cousins**

**Hand Remover, Cousins**



- Hands, cannon pinions, sweep wheels and chronograph driving wheel remover
- Hand remover for wrist watches
- Tips will not damage the dial
- Black handle
- Made in China

Code	Description	UOM	Price
H37692	Hand Remover, Cousins	EACH	£9.50

**PRICE PROMISE GUARANTEE**

**Hand Removing Tools (Watch), Indian**

**Hand Remover, Indian**

- Hands lifting tool
- Hand remover for wrist watches
- Traditional style of removing hands
- Made in India



Code	Description	UOM	Price
H37864	Hand Remover, Indian	EACH	£3.50

**WATCH JEWELLING TOOLS (BERGEON, KIF, INCA, NOVODIAC & SEITZ)**

**Incabloc Punch & Stake Set**



Incabloc - Swiss Made

Set of 6 punches and 7 stakes. Specially adapted to the different dimensions of the Incabloc shock absorber. An illustrated table clearly indicates the procedure for each type of block. Suitable for use with any staking tool having a fitting of diameter 4.7mm.

Contents:

- 7 Stakes Ext Ø x Hole Ø: 1.65 x 1.20, 2.00 x 1.60, 2.30 x 1.90, 2.50 x 2.00, 3.00 x 2.50, 3.50 x 3.00, 4.00 x 3.50mm
- 6 Punches sizes Ext Ø x Hole Ø: 1.57 x 1.20, 1.87 x 1.40, 2.07 x 1.60, 2.47 x 1.90, 2.97 x 2.40, 3.47 x 2.80mm

Code	Description	UOM	Price
I19223	Incabloc Punch & Stake Set	EACH	£64.95

**Kif Watch Parts**

See Page 168

**Incabloc Watch Parts**

See Page 165

**Kif Shockspring Tool**



Set of 3 special vertical keys for turning Kif Trior shock springs to accurately remove or refit without loss or damage.

- Tool with or without shocksprings
- Tool with shocksprings contains 5 x KIF 1-2, 5 x KIF 1-3 & 5 x KIF 1-4 springs
- Small, medium and large (Ø1.60, Ø1.90 & Ø2.10mm)
- Sizes given correspond to Kif diameter
- Swiss
- Pack\*3

Code	Description	UOM	Price
K0888	Kif Shockspring Tool	PACK*3	£22.75
K48080	Kif Shockspring Tool with Kif Shocksprings	PACK*3	£28.95
K39893	Ø1.60 Kif Shockspring Tool	EACH	£5.95
K39894	Ø1.90 Kif Shockspring Tool	EACH	£5.95
K39895	Ø2.10 Kif Shockspring Tool	EACH	£5.95

**Novodiac Shockspring Tools**



Novodiac Swiss Made

For removing and fitting the springs in Novodiac shock devices.

Code	Description	UOM	Price
N48217	ETA 2801, 2824.2, 2834.2, 2836.2 Novodiac Tool, A*F Swiss	EACH	£38.95
N48236	ETA 2801, 2824.2, 2834.2, 2836.2 Novodiac Tool, Horotec Swiss	EACH	£17.95
N48218	ETA 2671, 2660, 2671, 2688 Novodiac Tool, A*F Swiss	EACH	£38.95
N48237	ETA 2671, 2660, 2671, 2688 Novodiac Tool, Horotec Swiss	EACH	£17.95

**SAME DAY DISPATCH**

**Watchmakers Hammers**

See Page 911

**Pallet Alignment Tool, Bergeon**



- Bergeon 2229.03

This precision instrument enables micrometric adjustment of pallet stone position for length, lift, angle etc. prior to fixing - no need to remove staff and greatly simplifies this very exacting task.

Code	Description	UOM	Price
E9511	Pallet Alignment Tool, Bergeon 2229.03	EACH	£650.00

**Pallet Fork Burnisher, Bergeon**



- Bergeon 4847
- Swiss Made
- Pallet fork burnisher double ended
- One end to polish the fork notch
- Other to polish inside the horns

Code	Description	UOM	Price
B21024	Pallet Fork Burnisher, Bergeon	EACH	£69.95

**Seitz Jewelling Complete Outfit**



Seitz Jewelling Outfit

- Bergeon 30300
- Complete Set

- 1 Jewelling too
  - 12 Flat (simple) pushers
  - 4 Stakes
  - 12 Pump pushers
  - 11 Concave pushers
  - 15 Reamers with spindle
  - 4 Tools for reducing holes in plates
  - 4 Tools for reducing hour hand holes
  - 3 Tools for setting levers
  - 1 Platform stake
  - 1 Micrometer needle with stake
  - 1 Bush for nut
  - 1 Pusher and stake for lanterning cannon pinions
  - 1 Bakelite base
- In wooden case

Code	Description	UOM	Price
J0885	Seitz Jewelling Complet Outfit	EACH	£895.00

**ORDER tracking**

**Seitz Jewelling Tool with Spindle**



- Bergeon30300.P
- See PDF for Full Operating Instructions

Code	Description	UOM	Price
J31073	Jewelling Tool with Spindle, Bergeon 30300P	EACH	£268.75
J31074	Spindle with Head for Jewelling Tool, Bergeon 31002	EACH	£45.85
J31075	Spring For Spindle, Bergeon 31002.1	EACH	£1.25

**Seitz Jewelling Concave Pushers**

- Seitz - Bergeon 30521.1 & Size
- Replacement Concave Pushers
- Seitz 30300 Jewelling Outfit (J0885)

For driving in endstones

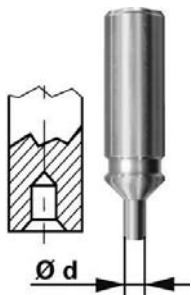

Code	Description	UOM	Price
J31078	Concave Pusher Set, Seitz	PACK*11	£45.50
J31056	Ø0.65mm Concave Pusher	EACH	£4.25
J31057	Ø0.75mm Concave Pusher	EACH	£4.25
J31058	Ø0.85mm Concave Pusher	EACH	£4.25
J30938	Ø0.95mm Concave Pusher	EACH	£4.25
J31061	Ø1.05mm Concave Pusher	EACH	£4.25
J30939	Ø1.15mm Concave Pusher	EACH	£4.25
J31059	Ø1.25mm Concave Pusher	EACH	£4.25
J31060	Ø1.35mm Concave Pusher	EACH	£4.25
J19448	Ø1.45mm Concave Pusher	EACH	£4.25
J31062	Ø1.55mm Concave Pusher	EACH	£4.25
J31063	Ø1.75mm Concave Pusher	EACH	£4.25

**Seitz Jewelling Pump Pushers**

- Seitz - Bergeon 30523-1 & Size
- Replacement Pump Pusher
- Seitz 30300 Jewelling Outfit (J0885)

For driving, for lowering balance jewels, flat jewels.

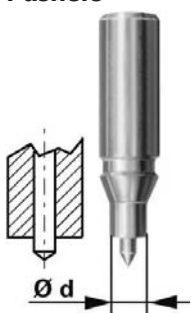

Code	Description	UOM	Price
J31079	Pump Pushers Set, Seitz	PACK*12	£220.00

J31064	Ø0.65mm Pump Pusher	EACH	£18.95
J31065	Ø0.75mm Pump Pusher	EACH	£18.95
J31066	Ø0.85mm Pump Pusher	EACH	£18.95
J30940	Ø0.95mm Pump Pusher	EACH	£18.95
J30941	Ø1.05mm Pump Pusher	EACH	£18.95
J30942	Ø1.15mm Pump Pusher	EACH	£18.95
J31067	Ø1.25mm Pump Pusher	EACH	£18.95
J31068	Ø1.45mm Pump Pusher	EACH	£18.95
J31069	Ø1.75mm Pump Pusher	EACH	£18.95
J31070	Ø1.95mm Pump Pusher	EACH	£18.95
J31071	Ø2.55mm Pump Pusher	EACH	£18.95
J31072	Ø2.95mm Pump Pusher	EACH	£18.95

**Seitz Jewelling Flat Pushers, (Simple)**

- Seitz - Bergeon 30520.A1 & Size
- Replacement Simple (Flat) Pusher
- Seitz 30300 Jewelling Outfit (J0885)

For driving, lowering flat jewels or endstones flush with tyre plate.



Code	Description	UOM	Price
J31077	Flat Pushers Set, Seitz	PACK*12	£84.65
J7531	Ø0.65mm Flat Pusher	EACH	£10.25
J30937	Ø0.75mm Flat Pusher	EACH	£10.25
J31051	Ø0.85mm Flat Pusher	EACH	£10.25
J18338	Ø0.95mm Flat Pusher	EACH	£10.25
J18339	Ø1.05mm Flat Pusher	EACH	£10.25
J31052	Ø1.15mm Flat Pusher	EACH	£10.25
J18340	Ø1.25mm Flat Pusher	EACH	£10.25
J18341	Ø1.45mm Flat Pusher	EACH	£10.25
J31053	Ø1.75mm Flat Pusher	EACH	£10.25
J31054	Ø1.95mm Flat Pusher	EACH	£10.25
J31055	Ø2.55mm Flat Pusher	EACH	£10.25
J18342	Ø2.95mm Flat Pusher	EACH	£10.25

**Seitz Jewelling Micrometer Needle and Stake**

- Seitz - Bergeon 30520.D
- Seitz Jewelling Outfit (J0885)

The jewellery tool can be used as a micrometer gauge. The hardened stake 30502.D2 (J31085) is fitted to the platform and the micrometer needle 30520.D1 (J31084) to the spindle.



Code	Description	UOM	Price
J31085	Micrometer Needle & Stake Set	PACK*2	£15.95
J31084	Micrometer Needle	EACH	£5.95
J30575	Stake Ø12mm for Micrometer Needle	EACH	£5.95
J30589	Stake Ø28mm, Bergeon 30520.C	EACH	£15.95

**Seitz Jewelling Pushers and Stake for Lanterning Cannon Pinions**

- Seitz - Bergeon 31001
- for use with Bergeon jewellery kit
- Cannon pinion tightening tool
- Items available as a set under item code: C4270



Fit the special punch to the spindle and the special stake to the platform of the jewellery tool. The blades must be exactly opposite each other and the micrometer screw must be set before the work is started.

Code	Description	UOM	Price
J30587	Pusher, Bergeon 31001.1	EACH	£11.85
J30588	Stake, Bergeon 31001-2	EACH	£6.50

**Seitz Jewelling Pushers and Stake for Levers**

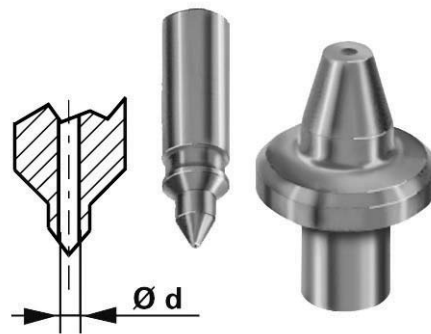

- Seitz - Bergeon 30525
- Replacement Pushers & Stakes
- Seitz 30300 Jewelling Outfit (J0885)

Lever's height on the pallet staff can be adjusted to within 0.005mm.

This is done by using the set of tools for setting levers.

Code	Description	UOM	Price
J31087	Lever Setting Set, Seitz	PACK*3	£22.95
J30584	Ø0.12mm Pusher for Setting Levers	EACH	£10.75
J30585	Ø0.18mm Pusher for Setting Levers	EACH	£10.75
J30586	Stake for Setting Levers	EACH	£4.50

**Seitz Jewelling Reamers**



- Seitz - Bergeon 30522A & Size
- Seitz - Bergeon 30522-B
- Reamer shank diameter Ø2.35mm
- Spindle for reamers
- Replacement reamers
- Seitz 30300 jewellery outfit (J0885)

For reaming holes for driving in larger jewels.

Code	Description	UOM	Price
J30573	Reamer Spindle	EACH	£15.25
J31076	Reamer Set, Seitz	PACK*15	£99.95
R7650A	Ø0.69mm Reamer	EACH	£6.85
R7650B	Ø0.79mm Reamer	EACH	£6.85
R19800	Ø0.89mm Reamer	EACH	£6.85
R7650C	Ø0.99mm Reamer	EACH	£6.85
R7650D	Ø1.09mm Reamer	EACH	£6.85
R7650E	Ø1.19mm Reamer	EACH	£6.85
R7650F	Ø1.29mm Reamer	EACH	£6.85
R7650G	Ø1.39mm Reamer	EACH	£6.85
R7650H	Ø1.49mm Reamer	EACH	£6.85
J31049	Ø1.59mm Reamer	EACH	£6.85
R7650I	Ø1.79mm Reamer	EACH	£6.85
R7650J	Ø1.99mm Reamer	EACH	£6.85
R7650K	Ø2.29mm Reamer	EACH	£6.85
R7650L	Ø2.59mm Reamer	EACH	£6.85
J31050	Ø2.99mm Reamer	EACH	£6.85



## Seitz Jewelling Reducing Hour Hand Hole Tools

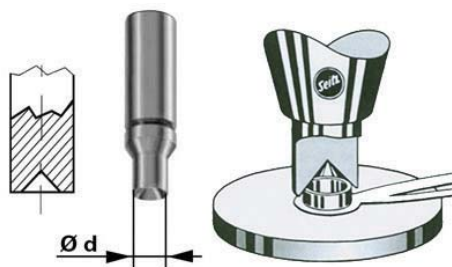

- Seitz - Bergeon 31000
- Set of 4 Tools
- Sizes: Ø1.25, 1.75, 2.25 & 2.75mm
- Seitz Jewelling Outfit (J0885)

Tools for reducing hour hand holes. These make it possible to reduce hand holes very accurately, to within 0.005mm. It is essential to use the micrometer screw for this work.

Code	Description	UOM	Price
J31086	Reducing Hour Hand Hole Tools Set	PACK*4	£19.85
J30580	Ø1.25mm Hour Hand Hole Reducing Tool	EACH	£7.50
J30581	Ø1.75mm Hour Hand Hole Reducing Tool	EACH	£7.50
J30582	Ø2.25mm Hour Hand Hole Reducing Tool	EACH	£7.50
J30583	Ø2.75mm Hour Hand Hole Reducing Tool	EACH	£7.50

## Seitz Jewelling Reducing Jewel Hole Tools

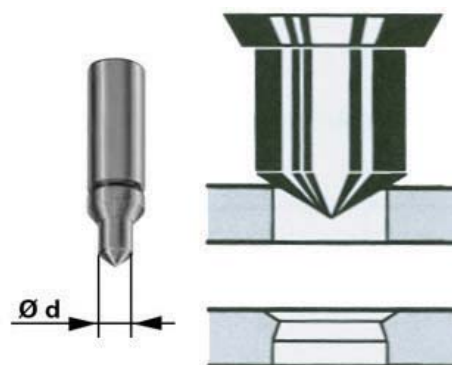

- Seitz - Bergeon 30524
- Set of 4 Tools
- Sizes: Ø1.00, 1.50, 2.00 & 2.50mm
- Seitz Jewelling Outfit (J0885)

Tools for reducing holes. These tools are useful when one wishes to avoid replacing a jewel that is still in good condition, but not held tightly enough in its hole.

Code	Description	UOM	Price
J31088	Reducing Hole Tools Set	PACK*4	£17.95
J30576	Ø1.00mm Reducing Jewel Hole Tool	EACH	£5.95
J30577	Ø1.50mm Reducing Jewel Hole Tool	EACH	£5.95
J30578	Ø2.00mm Reducing Jewel Hole Tool	EACH	£5.95
J30579	Ø2.50mm Reducing Jewel Hole Tool	EACH	£5.95

## Seitz Jewelling Stakes

- Seitz - Bergeon 30520-B
- Stakes for the platform
- Drill with hole & without hole
- Seitz Jewelling Outfit (J0885)



Code	Description	UOM	Price
J30574	Stakes Set, Seitz	PACK*4	£17.95
J31080	Ø1.50mm Stake, Non Perforated	EACH	£4.60
J31081	Ø2.00mm Stake, Perforated	EACH	£4.60
J31082	Ø4.00mm Stake, Perforated	EACH	£4.60
J31083	Ø5.00mm Stake, Perforated	EACH	£4.60

## WATCH PUSHER OR TUBE REMOVING AND FITTING TOOLS

### Multi Function Fitting & Removing Tools, Horotec

Horotec Swiss - Choice of 3 multi-function tools

Removing & fitting functions:

- Chronograph pusher external splines
- Pendant tube internal splines
- Oscillating rotor weight bolts
- Battery covers for Swatch, Fossil etc.
- See website "more info" for individual tool information
- Replacement tube, pusher & bolt keys are available and interchangeable

### 4 Multi Function Tool, Horotec MSA 03.621



- Horotec Swiss MSA 03.621
- 1, Chronograph Pushers
- 2, Pendant Tubes
- 3, Oscillating Rotor Weight Bolts
- 4, Battery Covers for Swatch, Fossil etc.

Consists of 17 interchangeable keys plus hand piece on stand (120 x 70 x 35mm)

Code	Description	UOM	Price
P19224	4 Multi Function Tool, Horotec MSA 03.621	EACH	£169.95

### 3 Multi Function Tool, Horotec MSA 03.623



- Horotec Swiss MSA 03.623
- 1, Chronograph Pushers
- 2, Pendant Tubes
- 3, Oscillating Rotor Weight Bolts

Consists of 14 interchangeable keys plus handpiece on stand (120 x 70 x 35mm)

Code	Description	UOM	Price
P19404	3 Multi Function Tool, Horotec MSA 03.623	EACH	£159.95

### 2 Multi Function Tool, Horotec MSA 03.622



- Horotec Swiss MSA 03.622
- 1, Chronograph Pushers
- 2, Pendant Tubes

Consists of 12 interchangeable Keys plus hand piece on stand (120 x 70 x 35mm)

Code	Description	UOM	Price
P19254	2 Multi Function Tool, Horotec MSA 03.622	EACH	£145.00

### Hand Piece, Horotec



Multi functional hand piece only for removing and fitting screw-on pushers or crown tubes, oscillating weight bolts and battery covers

- Horotec Swiss MSA 03.620-A

Code	Description	UOM	Price
P19255	Hand Piece, Horotec	EACH	£17.55

### Oscillating Weight Bolt Key for 2892

- Horotec Swiss MSA03.620.2892
- For calibres ETA 2892, 2893, 2894 & 2895



Code	Description	UOM	Price
P38795	Oscillating Weight Bolt Key for 2892	EACH	£23.95

### Oscillating Weight Bolt Key for 7750

- Horotec Swiss MSA03.620.7750
- For calibres Valjoux 7750 & ETA 2001.1



Code	Description	UOM	Price
P38796	Oscillating Weight Bolt Key for 7750	EACH	£25.50

**Pusher Key, Ø3.00mm**

- Horotec Swiss MSA03.620.P3



Code	Description	UOM	Price
P38792	Pusher Key, Ø3.00mm	EACH	£13.95

**Pusher Key, Ø3.50mm**

- Horotec Swiss MSA03.620.P27



Code	Description	UOM	Price
P38793	Pusher Key, Ø3.50mm	EACH	£13.85

**Pusher Key, Ø3.60mm**

- Horotec Swiss MSA03.620.P39



Code	Description	UOM	Price
P38794	Pusher Key, Ø3.60mm	EACH	£13.85

**Pusher Key, Ø4.35mm**

- Horotec Swiss MSA03.620.203



Code	Description	UOM	Price
P38790	Pusher Key, Ø4.35mm	EACH	£13.85

**Pusher Key, Ø4.80mm**

- Horotec Swiss MSA03.620.207



Code	Description	UOM	Price
P38791	Pusher Key, Ø4.80mm	EACH	£13.85

**Swatch Battery Cover Key, Gents**

- Horotec Swiss MSA03.620GENT
- Gents
- Ø14mm



Code	Description	UOM	Price
P38797	Swatch Battery Cover Key, Gents	EACH	£15.50

**Swatch Battery Cover Key, Ladies**

- Horotec Swiss MSA03.620LADY
- Ladies
- Ø10mm



Code	Description	UOM	Price
P38798	Swatch Battery Cover Key, Ladies	EACH	£15.50

**Swatch Battery Cover Key Medium**

- Horotec Swiss 03.620MED
- Medium
- Ø12mm



Code	Description	UOM	Price
P38799A	Swatch Battery Cover Key Medium	EACH	£15.50

**Tube Key, Ø1.50mm**

- Horotec Swiss MSA03.620.01



Code	Description	UOM	Price
P38783	Tube Key, Ø1.50mm	EACH	£12.95

**Ø1.80mm Tube Key**

- Horotec Swiss MSA03.620.02



Code	Description	UOM	Price
P38784	Ø1.80mm Tube Key	EACH	£13.95

**Tube Key, Ø2.65mm**

- Horotec Swiss MSA03.620.03



Code	Description	UOM	Price
P38785	Tube Key, Ø2.65mm	EACH	£14.50

**Tube Key, Ø2.75mm**

- Horotec Swiss MSA03.620.04



Code	Description	UOM	Price
P38786	Tube Key, Ø2.75mm	EACH	£14.50

**Tube Key, Ø2.95mm**

- Horotec Swiss MSA03.620.05



Code	Description	UOM	Price
P38787	Tube Key, Ø2.95mm	EACH	£13.70

**Tube Key, Ø3.00mm**

- Horotec Swiss MSA03.620.06



Code	Description	UOM	Price
P38788	Tube Key, Ø3.00mm	EACH	£13.85

**Tube Key, Ø3.00mm - Inverted**

- Horotec Swiss MSA03.620.07



Code	Description	UOM	Price
P38789	Tube Key, Ø3.00mm - Inverted	EACH	£12.95

**PRICE PROMISE GUARANTEE**



## Tube Key, Omega Seamaster

- 8 sided key for crown tube
- For Omega seamaster tubes
- Based on Omega tool 5100356
- Case Number 177.0519
- Necessary for the re-fitting of the threaded pendant tubes

A specific tube key is required for it's proper return without damage to the working surfaces.



Code	Description	UOM	Price
P47513	Tube Key, Omega Seamaster	EACH	£13.75

## Pendant Tube Fitting & Removing

Pendant Tube Fitting & Removing Tools

- For tubes with an internal spline
- Various external diameters
- Swiss Made & Other

## Multi Collet (internal) Spline Tool



Tool with Aluminium Handle & Multiple Collets  
4 Changeable Collets

- Smooth Ø3.00 to Ø3.25mm Tapered
- Smooth Ø2.70 to Ø2.90mm Tapered
- Spline Ø3.00mm Flute
- Spline Ø2.60mm Flute

Dimensions:

- Overall Length 110mm
- Handle Ø14mm

Weight 70g

Code	Description	UOM	Price
R33485	Multi Collet (internal) Spline Tool	EACH	£9.75

## Ø1.60mm (internal) Spline Tool

Horotec 03.665.01 - Swiss Made

- For tubes with an internal spline
- Rolex Generic pendant tube fitting and removing tool
- For screwdown crown pendant tubes with an internal spline Ø1.60mm
- Also suitable for Rolex generic tube C8359 ("Twin Lock" Ø5.3mm, 24.5300.0)
- Swiss made



Code	Description	UOM	Price
R8718	Ø1.60mm (internal) Spline Tool	EACH	£17.95

## Ø1.80mm (internal) Spline Tool

Horotec 03.665.02 - Swiss Made

- For tubes with an internal spline
- Rolex Generic pendant tube fitting and removing tool
- For screwdown crown pendant tubes with an internal spline Ø1.80mm
- Also suitable for Rolex generic tube C8360 ("Twin Lock" Ø6.0mm, 24.6000.0) and C8371 (old style oyster 3.00mm)
- Swiss made

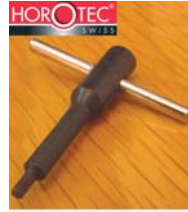

Code	Description	UOM	Price
R8719	Ø1.80mm (internal) Spline Tool	EACH	£17.95

## Ø2.70mm (internal) Spline Tool

COUSINSUK



- For tubes with an internal spline
- For screwdown crown pendant tubes with an internal spline Ø2.70mm
- Also suitable for Rolex generic tube C8367 (Ladies Oyster 24.5330.0) and C8368 (Ladies Oyster 24.5320.0)

Code	Description	UOM	Price
R12163	Ø2.70mm (internal) Spline Tool	EACH	£13.50

## Ø2.70mm (internal) Spline Tool

Horotec 03.665.04 - Swiss Made

- For tubes with an internal spline
- For Screwdown crown pendant tubes with an internal Spline Ø2.70mm
- Also suitable for Rolex Generic Tube C8367 (Ladies Oyster 24.5330.0) and C8368 (Ladies Oyster 24.5320.0)



Code	Description	UOM	Price
R19251	Ø2.70mm (internal) Spline Tool	EACH	£21.95

## Ø3.00mm (internal) Spline Tool

Horotec 03.665.06 - Swiss Made

- For tubes with an internal spline
- For screwdown crown pendant tubes with an internal spline Ø3.00mm
- Also suitable for Rolex Generic Tube C8363 (Daytona 24.7030.0) and C8370 (Gents Oyster 24.6020.0)
- Swiss made

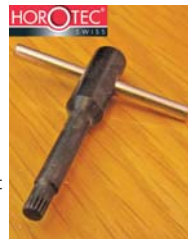

Code	Description	UOM	Price
R19252	Ø3.00mm (internal) Spline Tool	EACH	£21.95

## Ø3.00mm (internal) Spline Tool

COUSINSUK



- For tubes with an internal spline
- For screwdown crown pendant tubes with an internal spline Ø3.00mm

- Also suitable for Rolex Generic Tube C8363 (Daytona 24.7030.0) and C8370 (Gents Oyster 24.6020.0)

Code	Description	UOM	Price
R19259	Ø3.00mm (internal) Spline Tool	EACH	£13.50

## Chronograph Pusher Tube Fitting & Removing

Chronograph Pusher Tube Fitting & Removing Tools

- For tubes with an external spline
- Various external diameters
- Swiss Made
- High Quality

## Ø3.05mm (Internal) Spline Tool

Horotec 03.655 - Swiss Made

- For Screw In Chronograph Pusher Tubes
- For case tubes with an external spline
- Swiss Made



Code	Description	UOM	Price
P19253	Ø3.05mm (Internal) Spline Tool	EACH	£24.95

## Ø3.33mm (Internal) Spline Tool

BERGEON



- Bergeon 5901-P03
- For Screw In Chronograph Pusher Tubes
- For case tubes with an external spline
- Swiss Made
- Blue Handle

Code	Description	UOM	Price
P1431	Ø3.33mm (Internal) Spline Tool	EACH	£41.50

## Ø3.65mm (Internal) Spline Tool

BERGEON



- Bergeon 5901-P27
- For Screw In Chronograph Pusher Tubes
- For case tubes with an external spline
- Swiss Made

PRICE PROMISE  
GUARANTEE

• Red Handle

Code	Description	UOM	Price
P1432	Ø3.65mm (Internal) Spline Tool	EACH	£41.50

**Ø4.10mm (Internal) Spline Tool**



- Bergeon 5901-P39
- For Screw In Chronograph Pusher Tubes
- For case tubes with an external spline
- Swiss Made
- Yellow Handle

Code	Description	UOM	Price
P1433	Ø4.10mm (Internal) Spline Tool	EACH	£41.50

**Pusher and Corrector Fitting Pliers**



Pliers for fitting friction fitted watch pushers and correctors to watch cases. Cast aluminium frame with two adjustable pressure probes and slotted lower jaw Arms stop device to avoid over pressure.

- Bergeon 6161
- Length 145mm

Code	Description	UOM	Price
P1429	Pusher and Corrector Fitting Plier, Bergeon	EACH	£86.50

**Pusher and Corrector Removing Plier**



Pliers for removing friction fitted watch pushers and correctors to watch cases. Cast aluminium frame with three punches and centre arm stop device.

- Bergeon 6160
- Length 145mm

Code	Description	UOM	Price
P1430	Pusher and Corrector Removing Plier, Bergeon	EACH	£99.95
P7629	Ø5mm Spare Punch	EACH	£5.15
P7630	Ø8mm Spare Punch	EACH	£5.15
P7631	Ø12mm Spare Punch	EACH	£5.15

**Pusher & Pendant Tube Fitting & Removing Press**

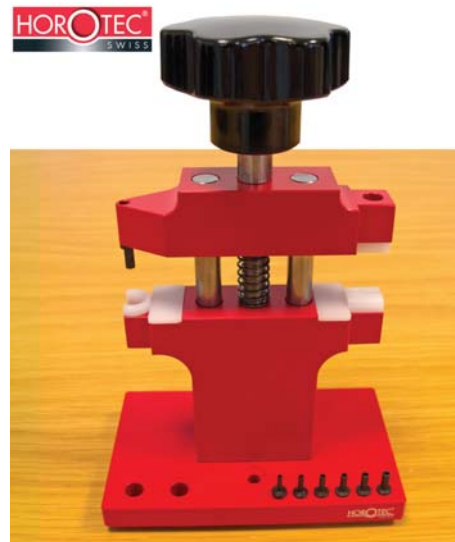

Horotec 03.657 - Swiss Made

- Press for fitting and removing pushers and pendant tubes with ease
- Minimizes the risk of damage to the pusher or tube
- Supplied 7 stakes
- 4 ridged rubber feet for extra stability
- Swiss made

Stake sizes (outside diameter x inside diameter):

- Ø1.55 x 1.05, 1.75 x 1.25, 1.95 x 1.45, 2.15 x 1.55, 2.45 x 1.55, 2.65 x 1.55 & 2.95 x 1.55mm

Code	Description	UOM	Price
P45772	Pusher & Tube Fitting & Removing Tool	EACH	£124.95

**WATCH STEM CUTTERS AND OILERS**

**Stem Cutters**



The specifically factory modified jaws (which give them an appearance of being out of alignment) actually ensure an even, perfect cut, when cutting watch stems from side on.

- High quality watch winding stem cutters
- A must for any manufacturer or repairer
- Provides a clean, flush cut
- Cut stems to required size
- Supplied with wooden box

Code	Description	UOM	Price
S41168	Stem Cutter	EACH	£72.50

**TODAY SAME DAY DISPATCH**

**Stem Cutter, Horotec Swiss**



Horotec 03.602 - Swiss Made

- Excellent tool for precisely cutting one or multiple watch stems
- Micrometric screw, graduated in 1/10mm allows exact setting of cut length
- Blocking screw so the length can be kept the same for batch work
- Extra ruler etched on base, 0-15mm
- Suitable for tap 9, 10 or 12 (Ø0.90, 1.00 or 1.20mm) stems
- Specific holding groove for each tap size

Code	Description	UOM	Price
C44218	Stem Cutting Tool, Horotec Swiss	EACH	£274.95

**Stem Cutting Gauge, Bergeon Swiss**



- Tool to measure stems precisely before cutting
- Excellent for batch work
- Rodin steel
- 33 x 23mm
- Bergeon 2002

Code	Description	UOM	Price
S46466	Stem Cutting Gauge, Bergeon 2002	EACH	£99.95

**Stem Oiler, Bergeon Swiss**



- Bergeon 2678 - Bergeon Swiss
- Tool specifically designed to ensure lubrication of the stem efficiently and easily
- Two (bottom and top) padded cushions
- Easy spring operation
- 80 x 40 x 60mm (L x W x H)

Code	Description	UOM	Price
O40218	Winding Stem Oiler, Bergeon 2678	EACH	£69.95

# WATCH STRAP CUTTING & HOLE MAKING TOOLS

## Hole Punching Plier

**VALUE**



Leather watch strap hole punching pliers. Box joint, plastic covered handles.

- Hole punching diameter: Ø1.80mm
- Spring loaded (double leaf springs)
- Sleeved arms
- Suitable for belt holes and other leather products
- Overall length 140mm

Code	Description	UOM	Price
S39497	Hole Punching Plier	EACH	£4.95

## Hole Punching Plier, Cousins Swiss Style

**COUSINSUK**



Leather watch strap hole punching pliers for Ø1.50mm holes.

- Cousins Swiss Style
- Superb Swiss quality
- Hole punching diameter: Ø2.00mm
- Box Joint
- Polished steel
- Suitable for belt holes and other leather products
- Length 130mm

Code	Description	UOM	Price
P47110	Ø2.00mm Hole Punch Pliers	EACH	£9.95

## Hole (Multi Size) Punching Plier, Maun

**MAUN**



Leather Watch Strap "Multi" Hole Punching Pliers.

Revolving drum system for cutting various diameter holes in leather. Top quality in nickel plated steel with easy grip handles. Drum locating spring ensures accurate positioning of the punches. Easy to use with six hardened steel punches.

- Maun 2230-200
- Hole punching diameters: Ø2.00, 2.50, 3.00, 3.50, 4.00 & 4.50mm
- Multi hole punches on a rotating wheel
- Overall length 200mm
- Suitable for Belts Holes and other Leather Products

Code	Description	UOM	Price
P4815	Multi Hole Punching Plier, Maun 2230-200	EACH	£12.25

## Hole (by Size) Punching Plier, Maun

**MAUN**



Maun Leather Watch Strap Single Size Hole Punching Pliers.

- Hole punching diameters: 1.0, 1.6, 2.0, 2.4, 2.8 & 3.2mm
- Overall length 125mm
- Suitable for belt holes and other leather products

Code	Description	UOM	Price
P31545	Ø1.00mm Single Hole Plier	EACH	£6.95
P4769	Ø1.60mm Single Hole Plier	EACH	£6.95
P31546	Ø2.00mm Single Hole Plier	EACH	£6.95
P31547	Ø2.40mm Single Hole Plier	EACH	£6.95
P31548	Ø2.80mm Single Hole Plier	EACH	£6.95
P31549	Ø3.20mm Single Hole Plier	EACH	£6.95

## Hole (by Size) Punching Plier, Bergeon

**BERGEON**



Bergeon 30225 - Swiss Made

- Leather Watch Strap Hole Making Plier
- Includes Ø1.00 & Ø1.50mm punches
- Length 160mm
- Pliers for punch
- Aluminium casting
- Pliers for punching holes in leather straps

Code	Description	UOM	Price
P1242	Bergeon Leather Watch Strap Hole Making Plier	EACH	£125.80

## Hole (by Size) Punching Tool, Bergeon Professional

**BERGEON**



Bergeon 31228 - Swiss Made

Industry professionals will appreciate this new Swiss made tool from Bergeon. The tool allows the professional to make holes in nearly any strap that are perfectly equidistant and perpendicular to the existing ones.

- Perfect for high end, expensive or branded straps
- Delivered with tools for holes with a diameter of Ø1.60mm and Ø2.00mm
- Can be used on leather, fabric & even rubber straps
- Aluminium structure, ergonomic design
- Stylish black wooden storage case
- Swiss made

Code	Description	UOM	Price
S44354	Strap Hole Punch Tool, Bergeon Swiss	EACH	£695.00

## Hole (Shaped) Punches

**VALUE**



Oval - Square - Rectangle

- For Leather Watch Straps without the traditional round punched holes
- 3 Punches in a set
- Oval 3x1.5mm
- Square 2x2mm
- Rectangle 3x1.5mm

Code	Description	UOM	Price
P19580	Special Shaped Hole Punch Set	PACK*3	£8.95

### Watch Strap Keepers

See Page 612



### Watch Strap Display Wallets

See Page 612



**Hole Cutter (Rotating)**



Watch Strap Hole Making Tool - Rotating Cutter

- 2 punches: Ø1.50mm & Ø2.00mm
- Leaves very clean cut holes
- Very different from the traditional punch style
- Supplied with acrylic base to avoid damage to the punches

Code	Description	UOM	Price
P39415	Hole Cutting Tool	EACH	£7.95

**Hole Cutter (Rotating), 6 Punches**



Watch Strap Hole Making Tool - Rotating Cutter - 6 Punches

- 6 Collets: 2x Ø2.50mm, 2x Ø2.00mm & 2x Ø1.50mm holes sizes
- Leaves very clean cut holes
- Very different from the traditional punch style

Code	Description	UOM	Price
S19579	Rotating Hole Cutting Tool	EACH	£15.25

**Notch Cutter Pliers, A\*F Swiss**



For producing notches in watch straps in leather or synthetic material. A heavy duty tool, beautifully finished in highly polished stainless steel with hardened jaws ensuring a clean cut.

- For watch cases which have threaded or pressure bars
- Length 130mm
- 1.5mm or 3mm width of cuts
- 8mm depth of cut

Code	Description	UOM	Price
P47112	1.5 x 8mm Notch Cutters	EACH	£19.95
P47111	3 x 8mm Notch Cutters	EACH	£19.95

**WORLDWIDE DELIVERY**

Most Popular Spring Bar Box Sets

See Page 635



**Notch Cutter Pliers, Cousins Swiss Style**



For producing notches in watch straps in leather or synthetic material. A heavy duty tool, beautifully finished in highly polished stainless steel with hardened jaws ensuring a clean cut.

- For watch cases which have threaded or pressure bars
- Length 130mm
- 1.5mm or 3mm width of cuts
- 8mm depth of cut
- Spring loaded (double leaf springs)
- Superb Swiss quality
- Cousins Swiss style

Code	Description	UOM	Price
P49171	1.5 x 8mm Notch Cutters	EACH	£9.95
P49172	3 x 8mm Notch Cutters	EACH	£9.95

**Notch Cutter Pliers, Indian**



For producing notches in watch straps in leather or synthetic material.

- Choice of 2 cut widths
- For watch cases which have threaded or pressure bars

Code	Description	UOM	Price
P44134	2mm Width Strap Notching Pliers	EACH	£4.95
P4915	3mm Width Strap Notching Pliers	EACH	£5.50

**Notch Cutter Tool, Bergeon**



Bergeon 6620 - Leather Watch Strap Notch Cutting Tool

- Pliers to cut multiple shapes into leather straps.
- Aluminium casting.
- Length 160 mm with adjustable strap guide.

Online Discounts

- Supplied with 1 die, 3 half round punches & 3 rectangular punches.

Code	Description	UOM	Price
P2965	Bergeon Leather Watch Strap Notch Cutting Tool	EACH	£215.00

**Notch Cutter Tool, Quick Release Spring Bars**



Notch Cutter Pliers - For Cutting Straps to Fit Quick Release Spring Bars

This pliers has been developed especially to cut a notch in a watch strap so that a quick release spring bar can be fitted.

- Be able to modify a watch strap so that you can fit quick release spring bars
- Takes seconds to use
- Modern top end watches already come with quick release spring bars
- Bergeon 30227
- Quick release spring bar set (for the latest European leather straps), our code S19187

Code	Description	UOM	Price
C32108	Bergeon Watch Strap Cutting Plier for Quick Release Spring Bars	EACH	£339.95
P35019	Center Pin For Bergeon Cutting Plier, Bergeon 30227-OE-06	EACH	£69.95

**Clamps for Open Ended Straps**



- Clamps the open ended straps in place to allow the adhesive to set
- Can be used with straps up to 28mm wide
- Protective felt pads wont damage the strap
- Felt pads: 22 x 28mm
- Overall size: 55 x 25 x 25 (L x W x H)
- An essential addition to your toolbox
- Pack\*2

Code	Description	UOM	Price
S45541	Clamps for Open Ended Straps	PACK*2	£3.95

Replacement Buckles

See Page 616



WATCH TOOL KITS

Battery Quickchange Kit



Battery Quickchange Kit

- 7 piece kit
- Everything you need for battery changes
- Supplied in plastic wallet
- Made in India

Kit contains:

- Case opener, twist action for screw on case backs
- Case opener, for snap on case backs
- Case knife with wooden handle (K39636)
- Dust off brush (S39290)
- Pliers (snipe nose) (P4780)
- Screwdriver, Ø2.00mm blade
- Tweezers (plastic) (T34701)
- Tweezers (brass) (T36486)

Code	Description	UOM	Price
K47430	Battery Quickchange Kit	EACH	£9.75

Bracelet Adjusting Kit



Bracelet Adjusting Kit

Kit contains:

- Wooden bracelet holding block (B36466)
- Bracelet pin removing punches: Ø0.80mm & Ø1.00mm
- 4 replacement pins: 2 x Ø0.80mm & 2 x Ø1.00mm
- Small ball pein hammer (H39469)

Code	Description	UOM	Price
K47062	Bracelet Adjusting Kit	EACH	£5.50

Bracelet Adjusting Kit



Bracelet Adjusting Kit - Split Pin Box Set

Kit contains:

- Box set of 180 watch bracelet split pins, sizes 5 to 22mm
- Bracelet holding block
- Bracelet pin removing set

- Watchmakers hammer
- Flat nose spring loaded pliers
- All supplied in plastic wallet

Code	Description	UOM	Price
B38760	Bracelet Adjusting Kit	EACH	£6.95

Watchmakers Quick Service Kit, Bergeon Swiss



Bergeon 7812 - Swiss Made

- 18 specialised tools & accessories
- Battery service
- Bracelet changing and shortening
- Case back opening and closing
- Supplied in plastic carry case, easy storage and transportation
- Sturdy protective foam inserts
- Handy kit for watchmakers
- All Bergeon Swiss tools

Kit contains:

- Jaxa mini (Bergeon 2819-MINI)
- 2.5 Screw rim eyeglass (Bergeon 2611-2.5)
- Plastic tweezers with counterweight (Bergeon 6460-P)
- 00 Anti-magnetic, stainless steel tweezers (Bergeon 7026-00)
- Ø1.00mm Stainless steel ergonomic screwdriver, with spare blade (Bergeon 30081-100)
- Ø1.60mm Stainless steel ergonomic screwdriver, with spare blade (Bergeon 30081-160)
- Case opening knife (Bergeon 7403)
- Flat nose pliers (Bergeon 2510-N)
- Bracelet pin removing tool, with two Ø0.80 pins (Bergeon 7230)
- Microfibre cloth, 220 x 220mm (Bergeon 7039)
- Flexible wrist measuring band (Bergeon 6789-N)
- Spring bar tool (Bergeon 6767-S)
- Spare pin & fork ends for spring bar tool (Bergeon 6767 A & B)

Code	Description	UOM	Price
K39010	Watchmakers Quick Service Kit, Bergeon Swiss	EACH	£125.95

Watchmakers Master Service Kit, Bergeon Swiss



Bergeon 7815 - Swiss Made

- 48 specialised tools & accessories
- Battery service
- Bracelet changing and shortening
- Case back opening and closing
- Supplied in plastic carry case, easy storage and transportation
- Sturdy protective foam inserts
- Extensive kit for watchmakers
- All Bergeon Swiss tools

Kit contains:

- Jaxa (Bergeon 2819-08)
- 3 x Flat, 3 x Notch, 3 x round hole & 3 x oyster tool bits (Bergeon 2819.A, 2819.B, 2819.C, 2819.D)
- Bracelet press with 6 pins, 10 blades & 2 adjustable bases (Bergeon 8745)
- Bracelet block (Bergeon 6744-P)
- 2.5 Screw rim eyeglass (Bergeon 2611-2.5)
- Plastic tweezers with counterweight (Bergeon 6460-P)
- 1 Anti-magnetic, stainless steel tweezers (Bergeon 7026-1)
- Ø1.00mm Stainless steel ergonomic screwdriver, with 2 spare blades (Bergeon 30081-100)
- Ø1.20mm Stainless steel ergonomic screwdriver, with 2 spare blades (Bergeon 30081-120)
- Ø1.40mm Stainless steel ergonomic screwdriver, with 2 spare blades (Bergeon 30081-140)
- Ø1.60mm Stainless steel ergonomic screwdriver, with 2 spare blades (Bergeon 30081-160)
- Ø2.00mm Stainless steel ergonomic screwdriver, with 2 spare blades (Bergeon 30081-200)
- Case opening knife (Bergeon 4932)
- Flat nose pliers (Bergeon 2510-N)
- Microfibre cloth, 220 x 220mm (Bergeon 7039)
- Flexible wrist measuring band (Bergeon 6789-N)
- Spring bar tool (Bergeon 3153-R)
- Spare pin & fork ends for spring bar tool (Bergeon 3153-R)
- Leather buff with buff protector (Bergeon 1282A & 4056-6)
- Steel Ruler (Bergeon 2819-08-C)
- Ø15 x 30mm plastic boxes x 6 (Bergeon2963-B)
- Dust blower (Bergeon 30540)

Code	Description	UOM	Price
T44217	Watchmakers Master Service Kit, Bergeon	EACH	£485.00

Watchmakers Basic Tool Kit



Watchmakers Professional Tool Kit

- 20 specialised tools & accessories
- Battery service
- Bracelet changing and shortening
- Case back opening and closing
- Supplied in varnished wooden box
- Made in India

Kit Includes:

- Adhesive, all purpose
- Bracelet pin remover with spare pins
- Bristle brush (B45713)
- Carborundum stone (S4746)
- Cutters (Side)
- Dust blower
- Eyeglass (x3 magnification)
- Oil for quartz watches

- Oil cup (O7983)
- Oiler
- Pegwood, Ø3mm (pack\*24) (P1111)
- Pin vice (double ended) (P5314)
- Pliers (Flat nose)
- Screwdriver set of 9
- Screwdriver Ø3.00mm (for clocks)
- Screwdriver Ø6.00mm (for clocks)
- Staking block (S47502)
- Tweezers, No.3
- Tweezers, No. AA
- Tweezers (cutting), No.D (T34700)

Code	Description	UOM	Price
K47428	Watchmakers Basic Kit	EACH	£33.95

**Watchmakers Professional Tool Kit**



**Watchmakers Professional Tool Kit**

- 26 specialised tools & accessories
- Battery service
- Bracelet changing and shortening
- Case back opening and closing
- Supplied in faux leather wallet
- Made in India

**Kit Includes:**

- Bracelet holding vice (B37143)
- Buff stick, black felt (B39032)
- Case cushion
- Case knife with wooden handle (K39636)
- Case opener (Twist action) (C32395)
- Dust blower
- Eyeglass, double lens (x10 magnification)
- Eyeglass, wooden (x5 magnification) (E37154)
- Hand fitting tools, set of 3 (H37241)
- Hand remover (H37692)
- Hand removing levers (H39643)
- Micro choc bracelet pin remover
- Movement holder (M38222)
- Oilers, set of 3
- Pin chuck with wooden handle (V39482)
- Polishing cloth
- Quartz watch oil (2ml)
- Rub off cleaning compound
- Reamers, set of 10 in plastic tube
- Scratch brush (fibreglass) (B0226)
- Sharpening stone (55 x 25 x 15mm) in wooden box
- Spring bar remover, aluminium (S42901)
- Tweezers, anti magnetic No.5
- Tweezers, anti magnetic No.3
- Tweezers, anti magnetic No.AA (T39593)
- Tweezers, plastic with stabiliser (T37828)

Code	Description	UOM	Price
K47429	Watchmakers Professional Kit	EACH	£49.95

**Watchmakers  
Portable Bench**  
See Page 648

**WATCH TOOLS SPECIFIC FOR ETACHRON**

**ETA Special Tools**

**Etachron Tool For Turning Studs, Bergeon**



Bergeon 6918  
Hand held tool for turning studs and balance spring buckles for ETACHRON

Code	Description	UOM	Price
E20150	Etachron Tool For Turning Studs, Bergeon	EACH	£25.95

**Etachron Tool For Removing Studs, Bergeon**



Bergeon 6919  
Hand held tool for removing the studs on ETACHRON

Code	Description	UOM	Price
E20151	Etachron Tool For Removing Studs, Bergeon	EACH	£24.50

**Etachron Tool For Removing Studs, Horotec**



Horotec 03.015  
Hand held tool for removing the studs on ETACHRON

Code	Description	UOM	Price
N48238	Etachron Tool For Removing Studs, Horotec	EACH	£16.95

**WATCH TOOLS SPECIFIC FOR OMEGA**

**Omega Tools**

- Omega Specific Specialist Tools
- Co-Axial Balance Regulating Tool
  - James Bond (1993) Helium Valve Pusher
  - Planet Ocean
  - Regatta
  - Seamaster
  - X-33

**Omega Genuine &  
Generic Parts**  
See Page 173

**Co-Axial Regulating (Square), Cousins**



CousinsUK - Non Swiss

For adjusting the balance wheel of Omega movements for co-axial calibres listed below that require a square timing key.

- Square timing key for all co-axial Omega movements
- For all co axial movements including calibres: 2300A, 2500A, 2500B, 2500C, 2610A, 2627A, 2628B, 3301A, 3303A, 3313B, 3603A, 3890A and similar

Code	Description	UOM	Price
X32818	Co-Axial Regulating (Square), Cousins	EACH	£44.95

**Co-Axial Regulating (Square), Omega Swiss**

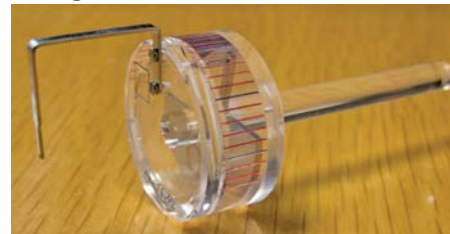

Omega - Swiss Made

For adjusting the balance wheel of Omega movements for co-axial calibres listed below that require a square timing key.

- Square timing key for all co-axial Omega movements
- For all co axial movements including calibres: 2300A, 2500A, 2500B, 2500C, 2610A, 2627A, 2628B, 3301A, 3303A, 3313B, 3603A, 3890A and similar

Code	Description	UOM	Price
X30550	Co-Axial Regulating (Square), Omega Swiss	EACH	£239.95

**Co-Axial Regulating (Tork), Cousins**



CousinsUK - Non Swiss

For adjusting the balance wheel of Omega movements for co-axial calibres listed below that require a torx timing key.

- Torx timing key for all co-axial Omega movements
- For all co axial movements including calibres: 8500 & 8501 and similar

Code	Description	UOM	Price
M44369	Co-Axial Regulating (Tork), Cousins	EACH	£44.95

**SAME DAY DISPATCH**



**Co-Axial Regulating (Tork), Omega Swiss**

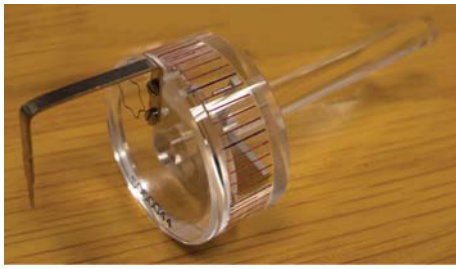

Omega - Swiss Made

For adjusting the balance wheel of Omega movements for co-axial calibres listed below that require a torx timing key.

- Torx timing key for all co-axial Omega movements
- For all co axial movements including calibres: 8500 & 8501 and similar

Code	Description	UOM	Price
X29133	Co-Axial Regulating (Tork), Omega Swiss	EACH	£299.95

**Die (Case Back) Planet Ocean Ø33.30mm, Omega Swiss**

Omega 508 0013



Code	Description	UOM	Price
X21126	Die (Case Back) Planet Ocean Ø33.30mm, Omega Swiss	EACH	£77.55

**Die (Case Back) Seamaster Ø20mm, Horotec**

Horotec 07.330.020  
• 5 Pin Metal Die

- Universal Fitting Dies for Tools:
- Bergeon Swiss
  - Horotec Swiss
  - Swiss Style

Fitting:  
• Universal = dies fit directly on to the tools

Code	Description	UOM	Price
M19220	Die (Case Back) Seamaster Ø20mm, Horotec	EACH	£24.95

**Die (Case Back) Seamaster Ø30mm, Horotec**

Horotec 07.330.030  
• 5 Pin Metal Die

- Universal Fitting Dies for Tools:
- Bergeon Swiss
  - Horotec Swiss
  - Swiss Style

Fitting:  
• Universal = dies fit directly on to the tools

Code	Description	UOM	Price
M19221	Die (Case Back) Seamaster Ø30mm, Horotec	EACH	£24.95

**Die (Case Back) Seamaster Ø20mm, Omega Swiss**

Omega 508 0012  
• For opening and closing Omega "Seamaster" case backs  
• Metal die



Code	Description	UOM	Price
X15210	Die (Case Back) Seamaster Ø20mm, Omega Swiss	EACH	£90.94

**Die (Case Back) Seamaster Ø30mm, Omega Swiss**

Omega 508 0011  
• For opening and closing Omega "Seamaster" case backs  
• Metal die



Code	Description	UOM	Price
X9550D	Die (Case Back) Seamaster Ø30mm, Omega Swiss	EACH	£90.94

**Die Holder (plus 2 Omega Seamaster Dies), Horotec**



Horotec Swiss 07.304 (M19219) is supplied with a Die Holder & 2 metal dies (5 pins) Ø20 & 30mm for Omega Seamaster ladies & Gents case backs. The dies will also fit any of our universal case back tools listed below.

- Universal Fitting Dies for Tools:
- Bergeon Swiss
  - Horotec Swiss
  - Swiss Style

Fitting:  
• Universal = dies fit directly on to the tools listed above

Code	Description	UOM	Price
M19219	Die Holder (plus 2 Omega Seamaster Dies), Horotec	EACH	£69.95

**Extractor Tube Set**



Omega 5100051  
• Used for Seamaster X-33 Crown & Pusher Tubes Helium Valve and De-Ville Co-Axial Tubes  
• Will also remove other helium valves (for fitting helium valves see tool X12513)

Instructions for Use:

- Take the Extractor in the hand wrench
- Insert the extractor inside the screwed Tube
- Force the extractor while turning Anti Clockwise
- With the help of the extractor
- Pull out the screwed tube in the direction it rotates
- Then screw out
- Once separated from the watch case
- Release the screwed tube from the extractor
- Block the body firmly with pliers and turn extractor clockwise
- Remove the titanium gasket
- Gasket can be released with small screwdriver
- By pressing from inside of it's seating
- Clean the residues of glue in the hole with a tap
- Burrs and remaining glue inside case clean with Mill Cutter
- Fit New Titanium gasket on the screw tube
- Cover the thread of the new screw tube with Loctite 243 ( Product Code C20803 )
- And screw it with specific key in the middle of case
- Allow to dry 24 hours

Code	Description	UOM	Price
X22225	Extractor Tube Set	EACH	£76.50

**WATCH TOOLS SPECIFIC FOR ROLEX**

**Microstella Regulating Tool for Rolex Balances**



Horotec 03.670

Micro-stella key used to adjust Rolex balance wheels. The tool fits the unique star head of the balance adjusting screws. Screwing in gives faster rate, screwing out slower rate.

- Calibres 2130, 3035, 3055, 3135, 3155 and similar
- Includes instructions

Code	Description	UOM	Price
R8717	Microstella Regulating Tool for Rolex Balances	EACH	£24.95

**Rolex Calibre Movement Holders**



Watch movement holders for specific Rolex calibres.

Horotec Swiss

Code	Description	UOM	Price
M9672	Movement Holder Cal. 1570	EACH	£10.95
M9673	Movement Holder Cal. 2135	EACH	£10.95
M9674	Movement Holder Cal. 3035	EACH	£12.95

**PRICE PROMISE GUARANTEE**

### Oscillating Rotor Weight Axle Punches



For Specific Rolex Calibres - Horotec Swiss

- For fitting & removing weight axles
- Improved version
- Swiss made
- Pack\*4
- Replacements available
- Horotec 03.666

Set contains:

- Calibre 1570 punch
- Calibre 2130 & 2135 punch
- Calibre 2235 punch
- Calibre 3035 & 3135 punch

Code	Description	UOM	Price
R44356	Axle Punch Set	PACK*4	£47.95
R15264	Calibre 1570 Axle Punch	EACH	£16.95
R15265	Calibre 2130 & 2135 Axle Punch	EACH	£16.95
R15266	Calibre 2235 Axle Punch	EACH	£16.95
R15267	Calibre 3035 & 3135 Axle Punch	EACH	£18.50

### Thread Cutting Tools



- Tool to easily cut the thread on Rolex cases
- Popular Rolex Oyster case sizes
- Ø5.30 or Ø6.00mm
- Stainless steel handles

Code	Description	UOM	Price
R44747	Ø5.30mm Thread Tapping Kit (For Rolex)	EACH	£39.95
R44748	Ø6.00mm Thread Tapping Kit (For Rolex)	EACH	£39.95

## WATCH TRAIN WHEEL REMOVING TOOLS

### 5 Spoke Wheel Remover, Bergeon

Bergeon 30638.3 - "Presto" Tools

- For removing wheels on third wheel arbors and for chronograph driving wheels with 5 spokes
- Blue handle



Code	Description	UOM	Price
W1850	Bergeon 5 Spoke Wheel Remover	EACH	£32.95

### 6 Spoke Wheel Remover, Bergeon

Bergeon 4079.3A - "Presto" Tools

- For removing wheels on third wheel arbors and for chronograph driving wheels with 6 spokes
- Red handle



Code	Description	UOM	Price
W1849	Bergeon 6 Spoke Wheel Remover	EACH	£31.95

### Wheel, Hand & Roller Remover, Bergeon



Bergeon 6016 - Swiss Made

- Fork shape
- Ø1.20 mm

The practical tool for removing:

- Intermediate wheels
- Minute and seconds hands
- Transmission wheels of chronographs
- The rollers

Code	Description	UOM	Price
W1851	Wheel Remover (Chrono Transmission) - Bergeon	EACH	£23.95

## WAX CARVING

The art of wax carving is the process of shaping wax using various tools & equipment.

- We have a wide selection of wax tools, all favourites within the industry
- To carve wax, you first need to choose the appropriate size and shape block or tube and in the preferred hardness of wax
- To smooth over the surface of your ready shaped wax, use some wire wool. Emery paper is likely to clog and not be as efficient
- After your wax mould is finished, excess wax that has been left over can be melted together and re-used to create other moulds in your casting processes

### 12 Piece Wax Carving Tool Kit



- Professional wax carvers/jewellers tool kit
- Supplied in a nylon pouch
- 12 different tools
- Great portable tool kit

Kit includes:

- Sliding brass vernier gauge (G31917)0
- 50mm square (S20127)
- Jewellers shears, straight end (P4796)

- Needle file set of 6
- Adjustable saw frame, 76mm deep (P4798)
- Ruler, 6 inch (R4911)
- Wax carver set of 5
- Wax file (W20148)
- Wax file set of 6 (W20147)

Code	Description	UOM	Price
K45710	12 Piece Wax Carving Tool Kit	EACH	£38.95

### Wax Burrs, Boring & Ball



A\*F Swiss

Great for boring and shaping holes in designing jewellery from wax carving and wood carving. The wide fluting on these wax burrs removes large amounts of material quickly and helps keep them clog-free for efficient, dependable cutting.

Six coarse-cut burrs that range in diameter from 1.6 to 5.0mm. Includes 4 round ball burrs and 2 boring burrs. Shaft Ø2.35mm (3/32"). Made in Switzerland.

Set Contains:

- Boring Burrs (A\*F 172.850): Ø1.60 - 2.30mm
- Ball Burrs (A\*F 172.851): Ø1.60 - 1.80 - 2.30 - 3.10 - 5.00mm

Code	Description	UOM	Price
B47263	Wax Burr Set, A*F Swiss	PACK*6	£36.95
B47266	Ball Burr Ø1.80mm, A*F Swiss	EACH	£4.50
B47267	Ball Burr Ø2.30mm, A*F Swiss	EACH	£4.50
B47268	Ball Burr Ø3.10mm, A*F Swiss	EACH	£6.95
B47269	Ball Burr Ø5.00mm, A*F Swiss	EACH	£8.75
B47264	Boring Burr Ø1.60mm, A*F Swiss	EACH	£3.70
B47265	Boring Burr Ø2.30mm, A*F Swiss	EACH	£3.70

### Wax Burrs, Hard Metal, Tungsten Carbide



A\*F Swiss

These coarse cut burrs are perfect not only for carving wax models but also good for wood working. Deep fluting and sharp teeth give a clean cut and fast result with no clogging.

Heads machined from tungsten carbide alloy for longer life. Ten different shapes mounted on industry standard Ø2.35mm (3/32") shanks.

Contains:

- Various shapes 12 to 14mm cutting length (ball Ø6mm)

Code	Description	UOM	Price
B47378	Hard Metal Wax Burr Set	PACK*10	£74.95



**Wax Carver - Foredom**



Foredom wax carver, excellent tools, produced by Foredom

- Precision heat control via a dial
- Temperature ranges from 35° Celsius (95° Fahrenheit) up to 294° Celsius (560° Fahrenheit)
- Suitable for delicate work or carving harder waxes
- Compact control box, taking hardly any desk space, only 64 x 51mm
- Detachable lightweight handpiece with cork insulation
- Brass tips are easy to clean and change
- Tips can be easily filed to desired shape
- Kit includes 3 tips (No.2, 3 & 4)
- Removable cords for easy storage when not in use
- Flashing LED shows heat intensity
- 230 Volt Transformer
- UK plug
- One year warranty
- CE marked
- Foredom USA

**Tip 2 (Straight Taper) Foredom**



- Tip 2
- Straight Taper
- For FDKWC2

Code	Description	UOM	Price
FDWT2	Tip 2 (Straight Taper) Foredom	EACH	£11.50

**Tip 3 (Knife) Foredom**



- Tip 3
- Knife
- For FDKWC2

Code	Description	UOM	Price
FDWT3	Tip 3 (Knife) Foredom	EACH	£11.50

**Tip 4 (Small Spoon) Foredom**



- Tip 4
- Small Spoon
- For FDKWC2

Code	Description	UOM	Price
FDWT4	Tip 4 (Small Spoon) Foredom	EACH	£11.50

**Tip 5 (Curved Taper) Foredom**



- Tip 5
- Curved Taper
- For FDKWC2

Code	Description	UOM	Price
FDWT5	Tip 5 (Curved Taper) Foredom	EACH	£11.50

**Tip 6 (Large Flat) Foredom**



- Tip 6
- Large Flat
- For FDKWC2

Code	Description	UOM	Price
FDWT6	Tip 6 (Large Flat) Foredom	EACH	£11.50

**Tip 7 (Large Spoon) Foredom**



- Tip 7
- Large Spoon
- For FDKWC2

Code	Description	UOM	Price
FDWT7	Tip 7 (Large Spoon) Foredom	EACH	£13.85

**Foredom Wax Carver Kit**



- Includes 3 tips (No.2, 3 & 4)
- 230 Volt Transformer
- UK plug
- One Year Warranty

Code	Description	UOM	Price
FDKWC2	Foredom Wax Carver Kit	EACH	£169.95

**Tip 1 (Small Flat) Foredom**



- Tip 1
- Small Flat
- For FDKWC2

Code	Description	UOM	Price
FDWT1	Tip 1 (Small Flat) Foredom	EACH	£11.50

**Handle Only, Foredom**



- Handle Only
- For FDKWC2

Code	Description	UOM	Price
FDWT82	Handle Only, Foredom	EACH	£75.95

**Handle Cord, Foredom**



- Handle Cord
- For FDKWC2

Code	Description	UOM	Price
FDWT86	Handle Cord, Foredom	EACH	£16.95

**Wax Carver Set of 4**



- Set of 4 wax carvers
- 4 distinct shapes
- Double ended tips
- For removing wax for wax modelling/sculpturing ready for casting
- Knurled handles
- Stainless steel
- Supplied in plastic wallet

Code	Description	UOM	Price
W39342	Wax Carver Set	PACK*4	£7.95

**Wax Carver Set of 7**

- Set of 7 wax carvers
- Double ended shaped tips
- For removing wax for wax modelling/sculpturing ready for casting
- Knurled handles
- Stainless steel
- Supplied with polished, hard wood stand
- Stand contains carborundum stone for sharpening
- Base: 105 x 65 x 40mm



Code	Description	UOM	Price
W39348	Wax Carvers Set on Wooden Stand	PACK*7	£12.95



### Wax Carver Set of 10

- Set of 10 wax carvers
- For removing wax for wax modelling/sculpturing ready for casting
- Plastic coated, comfy handles
- Stainless steel blades
- Supplied with in tidy storage and transportation box



Code	Description	UOM	Price
W42911	Wax Carver Set of 10	PACK*10	£11.95

### Wax Carver Set Of 12



- Set of 12 wax carvers
- Double ended shaped tips
- For removing wax for wax modelling/sculpturing ready for casting
- Knurled handles
- Stainless steel
- Supplied in plastic wallet

Code	Description	UOM	Price
C18356	Wax Carver Set	PACK*12	£5.25

### Wax Carver Set of 19



- Set of 19 wax carvers in easy use wallet
- Double ended shaped tips
- Superb for removing/shaping wax for modelling, sculpting and casting

Code	Description	UOM	Price
C36315	Wax Carver Set	PACK*19	£8.95



**SAME DAY DISPATCH**

Drill Bits

See Page 836



### Wax Carver Stand



Wax Carver Stand - Screwdriver Stand - With Sharpening Stone

- Polished hardwood base
- Stand contains carborundum stone for sharpening
- Great for wax carvers, screwdrivers or scribers
- Can hold 7 tools
- Ø6mm openings
- Base: 105 x 65 x 40mm

Code	Description	UOM	Price
W39349	Wax Carver & Screwdriver Stand	EACH	£7.95

### Wax Designing Ring Mandrel Kit



- Set of 19 Die Collets plus Stand
- Full size 4 - 13 with stand, the aluminium sleeves are clearly marked & finished smoothly so that wax models can slide off.

Design and produce your wax moulds with hands free ease

Code	Description	UOM	Price
M31886	Wax Designing Ring Mandrel Kit	EACH	£83.50

### Wax Files, Needle Set



Cousins UK - Invest in the Best

Excellent for shaping waxes and other materials, such as wood and plastic. Our files have a wide tooth style which prevents clogging as with conventional files.

Set Contains:

- Set of 6

- Length 140mm
- In plastic wallet
- Shapes: Pillar, Square, Triangle, Round, Half Round, Warding

Code	Description	UOM	Price
W20147	140mm Wax File Set	PACK*6	£3.65

### Wax Files, Swiss Style

VALUE

Cousins UK - Invest in the Best

A super economical double ended, half round file to be used with wax, wood, plastic. Excellent value, features two sides, medium and coarse. Has little or no clogging. A light knock is enough to loosen any clogging.



- Half round file
- Length 200mm (8")
- Double ended
- Medium & Coarse Cut

Code	Description	UOM	Price
W20148	Half Round (200mm) Medium & Coarse	EACH	£3.95

### Wax Files, Vul-Crylic, Vallorbe Swiss



Vallorbe Swiss - Invest in the Best

Swiss made double ended, half round file to be used with wax, wood, plastic. Excellent quality, features two sides, medium and coarse. Has little or no clogging. A light knock is enough to loosen any clogging.

- Vul-Crylic, Swiss Made
- Half round profile
- Length 150, 175 & 200mm (8")
- Double ended
- Medium & Coarse Cut
- Vallorbe 1540

Code	Description	UOM	Price
F47542	150mm (Ø12.50 x 3.50mm) File	EACH	£24.50
F47543	175mm (Ø12.50 x 3.50mm) File	EACH	£25.50
F47544	200mm (Ø12.50 x 3.50mm) File	EACH	£26.95

### Wax Lining Tools



- Set of 3
- A\*F Swiss
- Double ended
- Patterning tools for surface decoration on wax

Code	Description	UOM	Price
W19468	Wax Lining Tools	PACK*3	£51.95

### Wax Portable Pen



- Wax "Design Chief" Pen.
- Unique portable wax pen used for styling

and carving.

- Uses one AA battery.
- Wax Pen Supplied with regular straight Tip (W12257A)
- Made in USA

## Wax Portable Pen



- Wax "Design Chief" Pen.
- Unique portable wax pen used for styling and carving.
- Uses one AA battery.
- Wax Pen Supplied with regular straight Tip (W12257A)

Code	Description	UOM	Price
W12257	Wax Portable Pen	EACH	£22.95

## Tip (Regular Straight) Design Chief



- For Wax "Design Chief" Pen (W12257)

Code	Description	UOM	Price
W12257A	Tip (Regular Straight) Design Chief	EACH	£6.30

## Tip (Round) Design Chief



- For Wax "Design Chief" Pen (W12257)

Code	Description	UOM	Price
W12257B	Tip (Round) Design Chief	EACH	£6.30

## Tip (Elongated Straight) Design Chief



- For Wax "Design Chief" Pen (W12257)

Code	Description	UOM	Price
W12257C	Tip (Elongated Straight) Design Chief	EACH	£6.30

## Tips, Additional Shapes

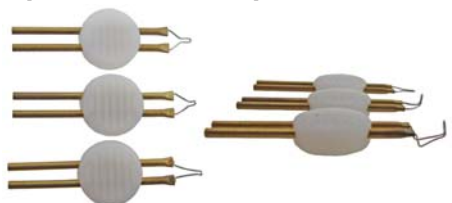

- For Wax "Design Chief" Pen (W12257)
- Pack of 3

• Additional shapes

Code	Description	UOM	Price
W32566	Tips, Additional Shapes	PACK*3	£14.85

## Wax Reamer & Detailer



- Essential tool for the wax carver jeweller, model maker and designer jewellery artist
- An excellent pinpoint to help with fine detailing whilst wax modelling.
- Carving to a filigree style
- With a spiral edge that will clean the area whilst your designing
- With wooden handle and over point cap

Length: 160mm

Weight: 10 grams

Code	Description	UOM	Price
R34929	Wax Reamer & Detailer	EACH	£4.50

## Wax Ring Stick

- Used for ensuring your wax is the correct size before you cut
- Metal with 6 or 4 blades for a professional finish
- Wooden for a lightweight, economical version

## Metal Wax Ring Stick



- All steel design
- Four cutting blades for professional finish
- Knurled handle for better grip
- Length 225mm
- Minimum diameter Ø11mm, maximum diameter Ø18mm

Code	Description	UOM	Price
W42899	Metal Wax Ring Stick	EACH	£19.95

## Metal Wax Ring Stick, A\*F Swiss



A\*F Swiss

- All steel design, black finish
- Six cutting blades for professional finish
- Knurled handle for better grip
- Length 225mm
- Minimum diameter Ø13.5mm, maximum diameter Ø20.0mm
- Weight: 350g

Code	Description	UOM	Price
C6260A	Metal Wax Ring Stick, A*F Swiss	EACH	£42.65

## Wooden Wax Ring Stick, ISO & European Sizes



- Hardwood mandrel
- Steel cutting blade
- One bladed giving you a smooth cutting action
- Lightweight
- European sizes 1 to 36
- ISO sizes 41 to 76
- Length 230mm

Code	Description	UOM	Price
R45723	Wooden Wax Ring Stick, ISO & European Sizes	EACH	£5.95

## Wooden Wax Ring Stick, US Sizes



- Hardwood mandrel
- Steel cutting blade
- One bladed giving you a smooth cutting action
- Lightweight
- Sizes: US sizes 2 to 14 or Ø14 to Ø23mm
- Length 230mm

Code	Description	UOM	Price
W36351	Wooden Wax Ring Stick, US Sizes	EACH	£4.95

## Wax Saw Blades, A\*F Swiss

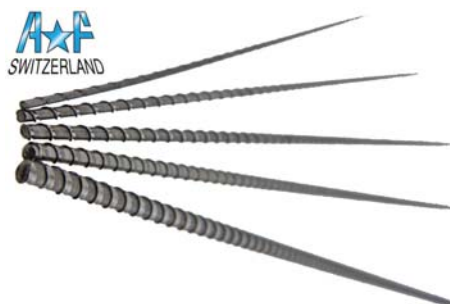

These round blades with a continuous spiral tooth are ideal for cutting thick pieces of wax. The spiral design allows straight cutting in any direction. They make cuts that are impossible with standard saw blades.

- A\*F Swiss
- Length 130mm
- Made from hardened steel
- Continuous spiral cutting edge
- Cuts many materials: wax, metal, plastic, rubber, bone etc.
- Any shape intricate curves, circles, squares
- Will not clog and can be easily cleaned
- Can be used in a saw frame or pin vice
- Safe will not cut human flesh
- Sold individually
- Fits onto Product Codes S19250, P4798, P4799, P4800 & P4801

Code	Description	UOM	Price
W18559	Ø0.70mm Wax Saw Blade	EACH	£3.25
W18560	Ø1.00mm Wax Saw Blade	EACH	£3.25
W18561	Ø1.30mm Wax Saw Blade	EACH	£3.25
W18562	Ø1.40mm Wax Saw Blade	EACH	£3.25
W18563	Ø1.90mm Wax Saw Blade	EACH	£3.25



Wax Saw Blades, German



A unique design for cutting wax, rubber, shell, plaster and more. The teeth spiral up the blade to permit cutting in all directions. They make cuts that are impossible with standard saw blades.

- Made in Germany
- Length 130mm
- Pack\*12
- Made from hardened steel
- Twist spiral cutting edge
- Cuts many materials: wax, metal, plastic, rubber, bone etc.
- Any shape, intricate curves, circles, squares
- Fits onto Product Codes S19250, P4798, P4799, P4800 & P4801

Code	Description	UOM	Price
W39897	Ø0.70mm Spiral Wax Saw Blades	Bund*12	£1.95
W39898	Ø0.77mm Spiral Wax Saw Blades	Bund*12	£1.95
W39899	Ø0.80mm Spiral Wax Saw Blades	Bund*12	£1.95
W39900	Ø0.94mm Spiral Wax Saw Blades	Bund*12	£1.95
W39901	Ø1.05mm Spiral Wax Saw Blades	Bund*12	£1.95
W39902	Ø1.07mm Spiral Wax Saw Blades	Bund*12	£1.95

Wax Scalpel Carving Kit



Scalpel - Carving Kit - Sharpening Stone

- Takes Universal Blades, Small Fitting
- Plastic Scalpel Handle (S36316)
- No. 10 Blade x 1 (Replacements S36354)
- No. 11 Blade x 1 (Replacements S36355)
- No. 12 Blade x 1 (Replacements S36356)
- Sharpening Stone, 100 x 10 x 10mm
- Supplied in plastic wallet

Caution: Blades are incredibly sharp

Code	Description	UOM	Price
S37635	Wax Scalpel Carving Kit	EACH	£2.50

WHEELS, MOPS, CONES & TRESS

Quick guide to polishing  
POLISHING METALS

IMPORTANT: The list below describes general polishing processes that are proved to work, there are other compound and mop combinations that work just as well. There are many factors involved regarding polishing some are listed below:

- Condition of the metal with determines where you start.
- Ideal speeds from 500 to 7000 rpm for your polishing motor
- Quality of the metal. This can vary depending on the quality of the cast or the condition of the second hand items you have obtained.

- Abrasives, get a good even surface with no deep scratches to ensure a deep mirror finish.
- Before you polish remove marks from the previous finish e.g. surface scratches / imperfections.
- Change direction where possible a few degrees in your polishing procedure.
- Try not to overload your mop with the compound you are using. You will place smear on your surface.
- Safety measures are important, use protective glasses, dust masks, finger protectors and aprons. With polishing you will always create dust in the atmosphere you are working in.
- Polishing is a process where you are removing a surface. Look at polishing motors with dust extractors and choose the size that handles your work load.
- If the mop becomes congested or filthy after use then use a mop dresser rake to bring new life into the mop. Never wash down mops in water or any other chemical.
- Always use one compound per grade of mop. Do not mix your compounds on your mop. If you do by accident use a Mop/Buf Dressing Rake
- Try not to do your polishing jobs if you feel tired and never remove any safety guards on your polishing units.
- Do not polish if you are wearing lose clothing for instance ties and long sleeved shirts etc.
- Good lighting is essential while you are polishing and after to inspect your work. See our range of lamps.
- Always ware protective Heath and Safety items.

Popular protective and safety accessories stocked:

- Denim Apron (A31282)
- Fingers protectors (P20862)
- Dust Masks (M6258)
- Eye protection goggles (G6257)
- Finger tape (F0667)

ALUMINIUM OXIDE WHEELS (FOR A MATT OR SATIN FINISH)

Composition of a spun polypropylene fibre in flap or lap format containing aluminium oxide greatly enhances its abrasive power to the extent that it will actually scratch glass.

Some uses for aluminium oxide wheels:

- Commonly used for light cleaning and rust removing work
- Obtaining a matt finish rings, bracelets, pendants, bangles and brooches
- Give contrasting effects on all surfaces, particularly watch graining, to create a matt finish to restore your old watch.
- Very good for the clock repairer and restorer to clean up oxidation/rust; fast effective way to remove old lacquer from aged clocks
- Using the 'fine' and 'very fine' grades gives you an effect similar to a frosted car windscreen

Ever wondered how they do the finish on gothic Celtic jewellery and models?

- Aluminium oxide wheels are used to create an antique finish using ageing ammonium hydrosulphide chemical, our code C6263, or metal ageing chemical CC60, our code C6264

- When you have blackened the item, use an aluminium oxide wheel to take off the silver ageing ammonium hydrosulphide chemical
- The areas the wheel can not reach will leave an aged effect on the piece
- In a time where antique jewellery is becoming more popular, this is a quick and easy way to obtain this look in a economical way

Flap



Aluminium Oxide - Flap Construction

- Ø100mm x 25mm
- Non woven mop, compressed material, best quality fibril
- Aluminium oxide for matt or satin finishing on most metals
- Also used for deburring and deoxidisation
- Wood centre bore easy winding on spindles
- Used dry and no compounds needed
- Used on a wide range of metals including brass, copper, gold, silver, platinum, palladium, titanium, pewter, tin, steel, iron and aluminium
- Each layer is in a flap circular radial blades formation making them last longer
- Aluminium oxide impregnated nylon

Grits available:

- Extra fine, grit 1000
- Fine, grit 320
- Medium, grit 240
- Coarse, grit 180

Code	Description	UOM	Price
P40243	Extra Fine (Grit 1000) Ø100 x 25mm	EACH	£5.50
P40242	Fine (Grit 320) Ø100 x 25mm	EACH	£5.50
P40241	Medium (Grit 240) Ø100 x 25mm	EACH	£5.50
P40240	Coarse (Grit 180) Ø100 x 25mm	EACH	£5.50

Price breaks available, see website

Flap, Bufflex



Bufflex Wheels - Aluminium Oxide - Flap Construction

- Bufflex brand
- Ø100mm x 25mm
- Non woven mop, compressed material, best quality fibril
- Aluminium oxide for matt or satin finishing on most metals
- Also used for deburring and deoxidisation
- Plastic centre bore easy winding on spindles
- Used dry and no compounds needed
- Used on a wide range of metals including brass, copper, gold, silver, platinum, palladium, titanium, pewter, tin, steel, iron and aluminium
- The Bufflex Wheels mops have very resilient and last longer when in use
- Each layer is in a flap circular radial blades formation making the Bufflex in use last longer

• Aluminium oxide impregnated nylon

Code	Description	UOM	Price
P8968	Very Fine (Ø100 x 25mm) Bufflex Wheel	EACH	£12.95
P8969	Fine (Ø100 x 25mm) Bufflex Wheel	EACH	£12.95
P8970	Medium (Ø100 x 25mm) Bufflex Wheel	EACH	£12.95
Price breaks available, see website			

## Lap



Satinwebb Wheels - Aluminium Oxide - Lap Construction

- 4" x 3" (Ø100 x 75mm)
- 3 lap
- Non woven mop, compressed material, best quality fibril
- Aluminium oxide for matt or satin finishing on most metals
- Also for deburring and de-oxidisation
- Leather and fibril centres
- Use dry, no compounds needed
- Used on a wide range of metals including brass, copper, gold, silver, platinum, palladium, titanium, pewter, tin, steel, iron and aluminium
- Very good to do large batch loads of work with economical spending
- Aluminium oxide impregnated nylon

Grits:

- Fine (grit 800)
- Medium (grit 400)
- Coarse (grit 240)

Code	Description	UOM	Price
P40236	Fine (Grit 800), 4" x 3" (3 Lap)	EACH	£2.25
P41039	Medium (Grit 400), 4" x 3" (3 Lap)	EACH	£2.25
P40237	Coarse (Grit 240), 4" x 3" (3 Lap)	EACH	£2.25
Price breaks available, see website			

## Lap, Sia Swiss



Satinwebb Wheels - Aluminium Oxide - Lap Construction - Sia Swiss

- Non woven mop, compressed material, best quality fibril
- Aluminium oxide for matt or satin finishing on most metals
- Also for deburring and de-oxidisation
- Leather and fibril centres
- Use dry, no compounds needed
- Used on a wide range of metals including brass, copper, gold, silver, platinum, palladium, titanium, pewter, tin, steel, iron and aluminium
- The Satin fibril mops has very good wear and last longer when in use
- Very good to do large batch loads of work with economical spending
- Multiple sizes, multiple laps
- One lap/layer is a ¼"/6.35mm
- Aluminium oxide impregnated nylon
- Sia Swiss

Grits:

- Very Fine - 280 grit
- Fine - 180 grit
- Medium - 120 grit
- Coarse - 80 grit

Code	Description	UOM	Price
P3567A	4" x 1" Very Fine (4 Lap)	EACH	£5.00

P3568A	4" x 1" Fine (4 Lap)	EACH	£5.00
P3569A	4" x 1" Medium (4 Lap)	EACH	£5.00
P3570A	4" x 1" Coarse (4 Lap)	EACH	£5.60
P3567B	4" x 1½" Very Fine (6 Lap)	EACH	£6.50
P3568B	4" x 1½" Fine (6 Lap)	EACH	£6.75
P3569B	4" x 1½" Medium (6 Lap)	EACH	£7.35
P3570B	4" x 1½" Coarse (6 Lap)	EACH	£7.75
P3567C	6" x ¾" Very Fine (3 Lap)	EACH	£5.15
P3568C	6" x ¾" Fine (3 Lap)	EACH	£5.25
P3569C	6" x ¾" Medium (3 Lap)	EACH	£5.80
P3567D	6" x 1" Very Fine (4 Lap)	EACH	£7.20
P3568D	6" x 1" Fine (4 Lap)	EACH	£7.50
P3569D	6" x 1" Medium (4 Lap)	EACH	£7.70
P3570D	6" x 1" Coarse (4 Lap)	EACH	£8.10
P3567E	6" x 1½" Very Fine (6 Lap)	EACH	£9.60
P3568E	6" x 1½" Fine (6 Lap)	EACH	£9.60
P3569E	6" x 1½" Medium (6 Lap)	EACH	£10.95
P3570E	6" x 1½" Coarse (6 Lap)	EACH	£11.75
P3567F	8" x 1" Very Fine (4 Lap)	EACH	£8.55
P3568F	8" x 1" Fine (4 Lap)	EACH	£8.55
P3569F	8" x 1" Medium (4 Lap)	EACH	£10.55
P3570F	8" x 1" Coarse (4 Lap)	EACH	£11.25
P3567G	8" x 1½" Very Fine (6 Lap)	EACH	£13.30
P3568G	8" x 1½" Fine (6 Lap)	EACH	£14.10
P3569G	8" x 1½" Medium (6 Lap)	EACH	£15.45
P3570G	8" x 1½" Coarse (6 Lap)	EACH	£16.55
Price breaks available, see website			

## ARTIFEX CONES

### Artifex Cones (Smoothing inside rings)



Artifex abrasive cones are made in Germany and guarantee some of the best results in the polishing industry.

Used for grinding, deburring, cleaning, descaling & polishing

- Used by jewellers, engineers, model makers and manufacturers
- Fantastic for inside rings
- The cones are comprised of silicon carbide with polyurethane bonding
- The foamed and open porous structure adjusts perfectly to the work piece and allows a cool grinding/polishing process
- Even under heavy usage, the cone does not need to be dressed with any polishing compound
- Artifex cones can be used on a whole range of metals including gold, silver, platinum, titanium, palladium, copper, brass, aluminium, cast iron and steel (including heat treated carbon steel)
- Due to their soft open porous structure, they are easy to shape to your required configuration
- Variety of grits and softnesses available, from deburring and grinding to final finishing
- MP = Medium hardness
- Grit (Hardness) x Smallest Diameter x Largest Diameter x Length
- Made in Germany

Grits available:

- 80 (Coarse) White
- 150 (Medium) Red
- 250 (Fine) Blue
- 400 (Very fine) Yellow

Code	Description	UOM	Price
P43078	80 Grit (MP) Ø15 x Ø22 x 65mm	EACH	£15.25

P4589	150 Grit (MP) Ø15 x Ø22 x 65mm	EACH	£15.95
P4590	250 Grit (MP) Ø15 x Ø22 x 65mm	EACH	£15.95
P43079	400 Grit (MP) Ø15 x Ø22 x 65mm	EACH	£18.25
Price breaks available, see website			

## ARTIFEX WHEELS

### Artifex wheels (Deburring/Grinding/Polishing/Final Finishing)



Artifex abrasive wheels are made in Germany and guarantee some of the best results in the polishing industry.

Used for grinding, deburring, cleaning, descaling & polishing

- Used by jewellers, engineers, model makers and manufacturers
- The wheels are comprised of silicon carbide with polyurethane bonding
- The foamed and open porous structure adjusts perfectly to the work piece and allows a cool grinding/polishing process
- Even under heavy usage, the wheel does not need to be dressed with any polishing compound
- Artifex wheels can be used on a whole range of metals including gold, silver, platinum, titanium, palladium, copper, brass, aluminium, cast iron and steel (including heat treated carbon steel)
- Due to their soft open porous structure, they are easy to shape to your required configuration
- Variety of grits and softnesses available, from deburring and grinding to final finishing
- Grit (Hardness) x Diameter x Thickness x Bore Size
- Made in Germany

Grits available:

- 46 (Very coarse)
- 80 (Coarse)
- 150 (Medium)
- 250 (Fine)
- 400 (Very fine)

Hardness (the harder the grain, the quicker the work. The softer the grain, the smoother the finish) :

- WP = Soft
- MP = Medium
- HP = Hard

Code	Description	UOM	Price
P43068	46 Grit (MP) Ø100 x 25 x 13mm	EACH	£25.95
P43069	46 Grit (MP) Ø150 x 25 x 13mm	EACH	£39.50
P43070	46 Grit (WP) Ø100 x 25 x 13mm	EACH	£23.50
P43071	46 Grit (WP) Ø150 x 25 x 13mm	EACH	£37.95
P43072	80 Grit (MP) Ø100 x 25 x 13mm	EACH	£23.65
P43073	80 Grit (MP) Ø150 x 25 x 13mm	EACH	£38.95
P43074	80 Grit (WP) Ø100 x 25 x 13mm	EACH	£21.75
P43075	80 Grit (WP) Ø150 x 25 x 13mm	EACH	£37.95
P4582	150 Grit (HP) Ø100 x 25 x 13mm	EACH	£23.90
P4586	150 Grit (HP) Ø150 x 25 x 13mm	EACH	£36.95
P4581	150 Grit (MP) Ø100 x 25 x 13mm	EACH	£22.95
P4585	150 Grit (MP) Ø150 x 25 x 13mm	EACH	£38.25
P4584	250 Grit (HP) Ø100 x 25 x 13mm	EACH	£26.95
P4588	250 Grit (HP) Ø150 x 25 x 13mm	EACH	£39.85

<b>P4583</b>	250 Grit (MP) Ø100 x 25 x 13mm	EACH	<b>£27.85</b>
<b>P4587</b>	250 Grit (MP) Ø150 x 25 x 13mm	EACH	<b>£39.40</b>
<b>P43076</b>	400 Grit (MP) Ø100 x 25 x 13mm	EACH	<b>£28.65</b>
<b>P43077</b>	400 Grit (MP) Ø150 x 25 x 13mm	EACH	<b>£42.50</b>
Price breaks available, see website			

## BRASS WHEELS

### Brass Wheels (Metal cleaning / texturing)



Brass Brush Wheels:

- Are very popular for Jewellers, Silversmiths, Clock Makers/Repairers, Light Engineers, Model Makers and for arts and crafts
  - Brass brushes are recommended for soft metals such as gold, silver, brass and bronze
  - Very economical and efficient method for batch work
  - Chains can be cleaned safely, easily for getting into awkward areas
  - Perfect for antique silverware and medal renovation
- Cousins Brass Wheels' wires are made from 100% brass. They are very popular and used to clean up or for texturing various types of metals.

The fine grade of wire gives a smooth shiny finish.

When using these fine brass wire brushes you should use soap or a detergent with water as a lubricant otherwise a dull layer of brass will be deposited on your metal particularly on silver.

The bristles of the wheel can penetrate deep recesses still giving an equal finish to a flat surface, without disrupting the shape of the piece; producing a brilliant finish with very little effort.

Brass brushes will not damage your pieces.

Cousins supply a perfect Scratch Brush machine, (S8597) to use with these brushes.

Code	Description	UOM	Price
<b>P40238</b>	Ø48mm, Fine	EACH	<b>£1.25</b>
<b>S32209</b>	Ø51mm Fine, Hatho Germany	EACH	<b>£2.95</b>
<b>P33351</b>	Ø65mm Fine, Metal Hub	EACH	<b>£2.75</b>
<b>P40239</b>	Ø90mm, Fine	EACH	<b>£4.50</b>
<b>P19591</b>	Ø100mm Fine	EACH	<b>£3.35</b>
<b>P19592</b>	Ø125mm Fine	EACH	<b>£3.40</b>
Price breaks available, see website			

## BRISTLE WHEELS



Examples of Converging and Straight Bristles

- Black Bristle
- White Bristle
- Black Bristle with Calico Interleave
- White Bristle with Scotch Brite interleave

- Grey / White Horse Hair
- White Goat Hair

Bristle Wheels are very popular in the polishing industry some of the usages are:

- excellent for polishing/brightening over stone setting like fine pave work, channel settings, rub over/bezel settings etc
- you will find that the bristles will get in-between the stone setting hence added brightness to the setting
- use before rhodium finishing; you will notice an enhanced brighter finish
- very good to get into grooves and shapes
- available in various grades to handle delicate or harsher work for finishing
- bristle wheels can be used on gold, silver, platinum, palladium, copper, brass, plastics, aluminium, pewter, tin, steel, and wood
- Max 2,000 - 2,800 r.p.m.
- Made in UK

The Bristle Wheels have very good wear and last longer when in use, very economical for batch work; used with the right bar of compounds you can get a high standard, bright finish.

Recommended compounds:

- P1388 Dialux Rouge
- P7809 Platinum Final Finish Polinum Polishing Compound
- P19467 Titanium & Stainless Steel Specialist Polinox Polishing Compound
- P1390 Steelbrite Final Finish Compound

The stiffness of each brush is determined by the number of rows (the more the stiffer), bristle length (the shorter the stiffer), and style (converging will be stiffer than straight).

### Hard (Extra Stiff) Reducing



- Coarse (extra stiff)
- Also Super Stiff for a harder stiffer bristle than extra stiff
- Plastic hubs (wooden where stated)
- High reducing
- Various diameters
- Straight or tapered bristles
- Rhino Brushes incorporate calico
- Made in UK

Code	Description	UOM	Price
<b>P31491</b>	Ø48mm (2 Row) Converging	EACH	<b>£0.85</b>
<b>P31492</b>	Ø50mm (1 Row) Straight	EACH	<b>£0.95</b>
<b>P31483</b>	Ø50mm (2 Row) Converging	EACH	<b>£0.95</b>
<b>P4845</b>	Ø57mm (3 Row) Converging	EACH	<b>£1.25</b>
<b>P5347</b>	Ø57mm (4 Row) Converging	EACH	<b>£2.40</b>
<b>P31484</b>	Ø63mm (2 Row) Converging	EACH	<b>£0.95</b>
<b>P31482</b>	Ø63mm (3 Row) Converging	EACH	<b>£1.40</b>
<b>P31487</b>	Ø70mm (2 Row) Converging	EACH	<b>£1.15</b>
<b>P31495</b>	Ø70mm (2 Row) Converging, Wooden Hub	EACH	<b>£1.20</b>
<b>P31490</b>	Ø80mm (3 Row) Converging	EACH	<b>£1.75</b>
<b>P31488</b>	Ø80mm (4 Row) Converging	EACH	<b>£2.20</b>
<b>P31485</b>	Ø80mm (4 Row) Converging, Super Stiff	EACH	<b>£3.00</b>
<b>P31493</b>	Ø80mm (4 Row) Converging, Wooden Hub	EACH	<b>£1.65</b>
<b>P31489</b>	Ø80mm (4 Row) Straight	EACH	<b>£2.20</b>

<b>P31486</b>	Ø80mm (4 Row) Straight, Super Stiff	EACH	<b>£3.00</b>
<b>P31494</b>	Ø80mm (4 Row) Straight, Wooden Hub	EACH	<b>£1.65</b>
Price breaks available, see website			

## Polishing Machine

Ref: P40516 See Page: 709

## FOREDOM® Polishing Machine

Ref: BL2CE See Page: 710

## Polishing Machine

Ref: P44755 See Page: 708

## DURSTON Online Tutorials



## Hard (Extra Stiff) Reducing, Rhino



Excellent for Platinum, Palladium and 18ct White Gold.

The Rhino Brush is an lathe brush combining rows of best pure bristle interleaved with super stiffened calico rows for durable general purpose polishing of platinum and chrome cobalt.

The Rhino Brushes are very popular in the polishing industry:

- they have a brass disc centre bores on both sides to strengthen the centre bore for added durability and a sturdy mount
- they have a straight bore that allows the hub to be turned and used on both sides for even wear and longer service life
- they are excellent for polishing/brightening over stone setting like fine pave work, channel settings, rub over/bezel settings etc
- they have bristles and calico material to get in-between the stone setting hence added brightness to the setting
- to be used before rhodium finishing; you will notice an enhanced brighter finish
- very good to get into grooves and shapes
- Rhino Brushes are used on gold, silver, platinum, palladium, copper, brass, plastics, aluminium, pewter, tin, steel and wood
- Made in UK

The Rhino Brushes have very good wear and last longer when in use, very economical for batch work; used with the right bar of compounds you can get a high standard, bright finish.

Recommended compounds:

- P1388 Dialux Rouge
- P7809 Platinum Final Finish Polinum Polishing Compound
- P19467 Titanium & Stainless Steel Specialist Polinox Polishing Compound
- P1390 Steelbrite Final Finish Compound

Code	Description	UOM	Price
P31497	Ø80mm (5 Row with Calico interleave) Tapered	EACH	£2.05
P30560	Ø80mm (5 Row with Stiffened Calico interleave) Tapered	EACH	£1.90
P31496	Ø80mm (7 Row with Calico interleave) Tapered	EACH	£2.80

Price breaks available, see website

## Medium (Stiff) Reducing



- Medium (stiff)
- Plastic, wooden or aluminium hubs
- Reducing
- Various diameters

- Straight or tapered bristles
- Black & White Bristles
- Made in UK

Code	Description	UOM	Price
P4822	Ø48mm (slimline) UK	EACH	£1.30
P31498	Ø48mm (slimline) UK, with Calico	EACH	£1.75
P4821	Ø48mm (slimline) UK, Aluminium Hub	EACH	£1.30
P41067	Ø65mm (2 Row) Converging	EACH	£1.25
P1283	Ø70mm (3 Row) Converging, Bergeon Swiss	EACH	£6.50
P1282	Ø70mm (3 Row) Straight, Bergeon Swiss	EACH	£6.25
P1285	Ø70mm (4 Row) Converging, Bergeon Swiss	EACH	£8.75
P1284	Ø70mm (4 Row) Straight, Bergeon Swiss	EACH	£8.75
P41063	Ø80mm (4 Row) Converging	EACH	£1.75
P31503	Ø80mm (4 Row) Converging, UK, White Bristle	EACH	£1.13
P41065	Ø80mm (4 Row) Converging, Wooden Hub	EACH	£1.75
P41064	Ø80mm (4 Row) Straight	EACH	£1.75
P31504	Ø80mm (4 Row) Straight, UK, White Bristle	EACH	£2.25

Price breaks available, see website

## Medium (Soft) Pre-Polish



- Medium (soft)
- Plastic hubs
- Pre-Polish
- Straight or tapered bristles
- Grey / White Horse Hair Bristles
- Made in UK

Code	Description	UOM	Price
P31500	Ø80mm (4 Row) Converging	EACH	£3.40
P31501	Ø80mm (4 Row) Straight	EACH	£3.40

Price breaks available, see website

## Fine (Soft) High Lustre



- Fine (soft)
- Plastic hubs
- High Lustre
- Straight
- Made in UK

2 rows of white best bristle with a plastic hub and an interleave of grit-free, soft scotch-brite for retention of pumice.

Provides exceptional polishing results and long life. Idea for wet and dry polishing. High shine finishing.

Code	Description	UOM	Price
P5102	Ø48mm (slimline) Aluminium Hub	EACH	£1.25
P31505	Ø55mm (Scotch Brite interleave) Straight	EACH	£2.58
P31506	Ø80mm (Scotch Brite interleave) Straight	EACH	£3.15
P41066	Ø80mm (4 row) Converging Wooden Hub	EACH	£2.95

Price breaks available, see website

## Extra Fine (Soft) Super High Lustre



- Extra Soft
- Plastic Hub
- Straight
- Super High Lustre
- Made in UK

Code	Description	UOM	Price
P31499	Ø48mm (slimline) Plastic Hub	EACH	£1.65
P31502	Ø80mm (4 Row) Straight	EACH	£2.06

Price breaks available, see website

## COTTON CONES

### Cotton Cones, Mounted



Cones - 100% Pure Cotton - Inside Ring Buffing

Excellent for the final, high mirror finishing.

Cotton Ring Buff Cones are final finishing inside mops. Use this mop after as the last stage mop to brighten your final finish. So you can get a very high grade of mirror finishing.

- Are very popular for Jewellers, Silversmiths, Light Engineers, Model Makers and in Arts and Crafts.
- Cotton Ring Cones can be used on a whole range of metals such as gold, silver, platinum, titanium, palladium, copper, brass, aluminium and steel.
- Cotton Ring Cones are very useful for getting into spherical awkward circular areas for example, inside rings and bangles.
- Wooden centre with metal core strengthening ring
- One of the most popular final finishing inside ring and bangles mops in the polishing industry
- Also known in the trade as a mirroring quality inside mop
- When you use Cotton Ring Cones mops it holds its shape very well and you can push up your pieces to get into those awkward areas.
- You will find the Cotton Ring Cones maintains durability whilst still offering a quality high final mirror finish.
- An ideal mop get the expert finishing mirror shine on your work.

The Cotton Ring Cones mops are resilient when in use. Cotton Ring Cones are ideal for large quantities of work with economical spending. Used with the right bar of compounds you can get a very high standard mirror finish.

Recommend compounds

- P1388 Dialux Rouge
- P1397 A A rouge
- P3659 Britelea ff9
- P7809A Platinum Superior Final Finish Polishing Compound

Cousins' supplies polishing equipment, we recommend the following best sellers to use with our extensive range of polishing accessories:

- Polishing Motor Twin With Extractor Fan (Ventura 2) - P8760
- Polishing Motor Variable Speed, Foredom - BL2CE
- Polishing Motor Twin On Base With Extractor Fan (Polimax 1) - P8670

Code	Description	UOM	Price
P3530A	65mm x 110mm Cotton Ring Buff	EACH	£7.40
P3530C	70mm x 110mm Cotton Ring Buff	EACH	£7.50
P3530D	70mm x 110mm Cotton Ring Buff - Slim	EACH	£7.80
P3530B	75mm x 115mm Cotton Ring Buff	EACH	£7.80

Price breaks available, see website

## COTTON WHEELS

### Cotton Wheels



100% Pure Cotton - Excellent for Final, High Mirror Finishing

Cotton Wheel are final finishing mops. Use this mop after as the last stage mop to brighten your final finish. So you can get a very high grade of mirror finishing.

- Are very popular for Jewellers, Silversmiths, Light Engineers, Model Makers and in Arts and Crafts.
- Cotton Wheel can be used on a whole range of metals such as gold, silver, platinum, titanium, palladium, copper, brass, aluminium and steel.
- Cotton Wheel are very useful for getting into spherical awkward circular areas for example, inside bangles.
- Wooden centre easy wind on
- One of the most popular final finishing mops in the polishing industry
- Also known in the trade as a mirroring quality mop
- When you use Cotton Wheel mops it holds its shape very well, and you can push up your pieces to get into those awkward areas.
- You will find the Cotton Wheel maintains durability whilst still offering a quality high final mirror finish.
- An ideal mop get the expert finishing mirror shine on your work.
- Max rev 3200

The Cotton Wheel mops are resilient when in use. Cotton Wheel are ideal for large quantities of work with economical spending. Used with the right bar of compounds you can get a very high standard mirror finish.

Recommend compounds

- P1388 Dialux Rouge
- P1397 A A rouge
- P3659 Britelea ff9
- P7809A Platinum Superior Final Finish Polishing Compound

Cousins' supplies polishing equipment, we recommend the following best sellers to use with our extensive range of polishing accessories:

- Polishing Motor Twin With Extractor Fan (Ventura 2) - P8760
- Polishing Motor Variable Speed, Foredom - BL2CE
- Polishing Motor Twin On Base With Extractor Fan (Polimax 1) - P8670

Code	Description	UOM	Price
P1286	Ø60mm x 20mm, Bergeon Swiss	EACH	£18.15
P5168	Ø60mm x 30mm, E.U	EACH	£4.95
P40235	Ø80mm x 30mm	EACH	£3.75
P5169	Ø80mm x 40mm, E.U	EACH	£5.75

P5170	Ø100mm x 50mm, E.U	EACH	£7.20
-------	--------------------	------	-------

Price breaks available, see website

## DE-OXIDATION WHEELS (ALSO FOR A MATT OR SATIN FINISH)

### De-Oxidation Wheels



Bergeon De-Oxidation Wheel:

- is a non woven mop hosting compressed material, a best quality fibril
- is a silicon carbide for matt or satin finishing on most metals
- is also used for deburring and deoxidisation
- has a plastic centre hub easy for winding onto spindles
- are used dry, no compounds needed
- are used on a wide range of metals including brass, copper, gold, silver, platinum, palladium, titanium, pewter, tin, steel, iron, and aluminium
- has an excellent robust durability.
- each layer consists of a flap which sits horizontally on the hub so a larger surface area of the flap comes into contact with the work area, whilst insuring durability of the wheel also.

Some of the usages Bergeon De-Oxidation Wheels:

- commonly used for light cleaning and rust removing work.
- gives a satin/matt finish on rings, bracelets, pendants, bangles, and brooches.
- adds a contrast texture to jewellery finishing.
- use for watch graining; create a matt finish to restore your old watch (bracelets, clasps etc...). Often used in combination with Polyimide Protection Tape (references start from T19961 and T31384) to texture bracelets, designs which are highly fashionable on many branded watches, including Rolex, Omega and others.
- superb for the clock repairer and restorer, as a fast, effective way to remove old lacquer, oxidation and rust from aged clocks.

Have you ever wondered how the finish on Gothic and Celtic jewellery and models is achieved?

- to create an antique finish: First use Ageing Ammonium Hydrosulphide Chemical our code (C6263) or Metal Ageing Chemical CC60 (C6264). When you have blackened the piece use Bergeon Wheel to take off the Silver Ageing Ammonium Hydrosulphide Chemical, the areas in which the mop doesn't reach will remain partly blackened hence giving an aged effect.
- Using the fine and very fine grades it gives the effect of a frosted car windscreen.
- In a time when retro/antique jewellery is coming back into fashion, this is a quick and easy way to obtain this effect in an economical way.

Specification:

- Ø100mm
- 20mm Wide
- 6mm bore
- Suggested 2800rpm
- Max 5500rpm

Code	Description	UOM	Price
P2539	Ultra Fine (Ø100mm) Bergeon 6085.E4	EACH	£19.95
P2538	Very Fine (Ø100mm) Bergeon 6085.E3	EACH	£19.95
P2537	Fine (Ø100mm) Bergeon 6085.E2	EACH	£19.95

P2536	Medium (Ø100mm) Bergeon 6085.E1	EACH	£19.95
-------	---------------------------------	------	--------

Price breaks available, see website

## DIAMOND IMPREGNATED WHEELS

### Diamond Impregnated Wheel



Cousins diamond impregnated wheels, impressive tooling at a value price.

Electroplated diamond particles are the ultimate material for all metal cutting, removing, and texturing.

- Ø100mm
- 1mm thick edge
- Ø20mm bore
- Max RPM 12000

Diamond texturing/cutting/sanding:

- Add a fine fantastic texturing effect on jewellery. When texturing with these wheels the unique diamond particles will transfer the effect onto the piece leaving the same glittering finish on the metals as it looks on the wheel itself. I.e. The finish looks like glitter has been sprinkled onto the piece
- Ideal to create the perfect channel mounts with fast cutting properties ready for stone setting
- Most popular texturing effects in Asian Jewellery before the diamond milling process known as the Shubernum effect
- Grinds/smooths away excess metal such as solder
- Used in the glass, engraving and sculpture industry puts a misty / frosty effect on glass and grind/shape ceramics with ease
- Very popular with jewellers, silversmiths, watch makers/repairers, light engineers, model makers plastic fabricators and in arts and crafts
- Can be used on a whole range of materials such as gold, silver, platinum, copper, brass, pewter, bronze, glass aluminium, and ceramics
- Precious metal testing grind/remove surface if plated before testing with Acid testing Bottles
- Finest quality for reliability, long life and satisfaction guaranteed
- For glass engraving / texturing & reaming stones and beads, always use water as a lubricant with diamond tools / instruments
- No lubrication required for texturing on metal

Code	Description	UOM	Price
D46589	Ø100 x 20mm Diamond Wheel	EACH	£4.95

## EMERY FLAP WHEELS

Flap Wheels are used in a number of different ways some uses include removing oxidation, marks, scratches, rust, paints and lacquers on metals; cleans and smooths metals simultaneously for a universal finish.

A favourite amongst engineers, antique car restorers, clock restorers, iron fabricators, sculptors and model makers; they are also used in arts and crafts.

Have you ever had an Iron Gate or fence which needs a new look? Flap wheels:

- are commonly used on a hand held electrical drill, however with the appropriate apparatus they can be used with a number of different drills
- do not need compounds and are to be used dry.
- can be used on a wide range of metals including brass, copper, pewter, tin, steel, iron, and aluminium
- sit horizontally on the hub so a larger surface area of the flap comes into contact with the work area, whilst insuring durability of the wheel also.

## Emery Flap Wheels



Cleaning - Reducing - Smoothin

Garryson is a UK manufacturer of speciality flap wheel abrasives, designed and engineered to suit virtually every power tool in the market.

Garryson flap wheels are widely used in a variety of industries and in many different applications, including the removal off all types of metal, blending, finishing or polishing on a vast range of materials; including irons, steels, aluminium, alloys or non ferrous metals.

Garryson flap wheels are specially engineered to combine operations therefore resulting in reduced downtime and substantial cost savings.

Flap wheels are modern, cost effective surface finishing tools suitable for grinding and polishing on flat and contoured surfaces when working on metals, wood, rubber and plastics. The flap wheel designs are such that as they wear, a new abrasive is exposed.

This prevents clogging and gives a uniform, constant finish throughout the wheels life. They are easy to use and control and will not dig into the work piece. The high quality abrasive cloth is secured to the centre with epoxy resin giving durability.

- We supply an excellent Einhell Hand Drill (code D33521) with additional flex drive shaft (code S33155) a perfect combination piece to use with these flap wheels.
- Mounted on a 6mm diameter shank.
- Large range of grades and sizes are available.

Code	Description	UOM	Price
P34138	Ø30 x 15mm (Grit 60) Flap Wheel	EACH	£2.30
P34139	Ø30 x 15mm (Grit 80) Flap Wheel	EACH	£2.30
P34140	Ø30 x 15mm (Grit 120) Flap Wheel	EACH	£2.30
P34141	Ø40 x 30mm (Grit 60) Flap Wheel	EACH	£2.55
P34142	Ø40 x 30mm (Grit 80) Flap Wheel	EACH	£2.55
P34143	Ø40 x 30mm (Grit 120) Flap Wheel	EACH	£2.55
P34144	Ø50 x 30mm (Grit 60) Flap Wheel	EACH	£2.85
P34145	Ø50 x 30mm (Grit 80) Flap Wheel	EACH	£2.85
P34146	Ø50 x 30mm (Grit 120) Flap Wheel	EACH	£2.85
P9484A	Ø60 x 30mm (Grit 60) Flap Wheel	EACH	£3.50
P34148	Ø60 x 30mm (Grit 80) Flap Wheel	EACH	£3.50
P34149	Ø60 x 30mm (Grit 120) Flap Wheel	EACH	£3.50
P34150	Ø80 x 30mm (Grit 40) Flap Wheel	EACH	£6.10
P34151	Ø80 x 30mm (Grit 60) Flap Wheel	EACH	£6.10
P34152	Ø80 x 30mm (Grit 80) Flap Wheel	EACH	£6.10
P9484B	Ø80 x 50mm (Grit 80) Flap Wheel	EACH	£6.25

## FELT CONES



Felt cones have excellent resilience and last longer when in use. Used with the appropriate compounds you can get a high standard, semi-bright mirror finish for inside rings & any type of cylindrical object.

Felt Cones:

- Are very popular for jewellers, silversmiths, light engineers, model makers and in arts and crafts.
- Can be used on a whole range of metals such as gold, silver, platinum, titanium, palladium, copper, brass, aluminium and steel.
- Are very useful for getting into spherical awkward circular areas for example, inside rings and bangles
- Can be mounted onto pendant drill spindles in order to reach awkward areas, with felt (code P3542) mounted on a mandrel (P1345M).
- Are superb to get an expert polish inside rings and bangles.
- Are a very economical and efficient method for batch work.
- P3534 and P3535 codes have a metal support ring on the base strengthens the cone when winding onto the spindle.

Recommend compounds

- P1388 Dialux Rouge
- P7809 Platinum Final Finish Polinum Polishing Compound
- P1394 Hyfin Final Finish Compound
- P1410 Tripoli General Purpose Polishing Compound

## Bullnose Cone



Excellent for getting into domed shapes, cups, vases etc.

- Dimensions Length 45mm x Ø22mm
- White Hard Felt

Code	Description	UOM	Price
P3540	Bullnose Ø22mm x 45mm	EACH	£1.95

Price breaks available, see website

## Bullnose Cone, Mounted



Excellent for getting into domed shapes, cups, vases etc

- White felt
- Mounted on wooden hub

Dimensions:

- Felt Length x Width

Code	Description	UOM	Price
P39313	Bullnose Mounted 75 x Ø20mm	EACH	£2.50
P39314	Bullnose Mounted 100 x Ø20mm	EACH	£2.75
P39315	Bullnose Mounted 125 x Ø25mm	EACH	£3.45
P39316	Bullnose Mounted 150 x Ø30mm	EACH	£4.75

## Conical Cone



Popular for inside rings, kids or adults sizes are catered for. Rings are easy for the polisher to mount on and off this shape as it comes to a point.

- Multiple sizes
- Made in UK, Bergeon Swiss or far east
- Diameter x length

Code	Description	UOM	Price
P31650	Ø15mm x 25mm, Made in UK	EACH	£1.25
P3542	Ø16mm x 45mm, Made in UK	EACH	£1.55
P31651	Ø19mm x 44mm, Made in UK	EACH	£1.70
P40234	Ø25mm x 50mm	EACH	£1.25
P31652	Ø25mm x 50mm, Made in UK	EACH	£2.35
P1280A	Ø25mm x 50mm, Bergeon Swiss	EACH	£7.95
P3541	Ø25mm x 75mm Conical Felt Cone	EACH	£3.95

Price breaks available, see website

## Cylinder 50 x Ø50mm



- Ø50mm (approx)
- 50mm length
- 90mm overall length
- Wooden mount

Code	Description	UOM	Price
B39299	Cylinder 50 x Ø50mm	EACH	£5.95

WORLDWIDE DELIVERY



ORDER tracking

www. Online Discounts

### Cylinder, Non Mounted

Felt cylinders have excellent resilience and last longer when in use. Used with the appropriate compounds you can get a high standard, semi-bright mirror finish for inside rings & any type of cylindrical object.



**Felt Cylinders:**

- Are very popular for jewellers, silversmiths, light engineers, model makers and in arts and crafts.
- Can be used on a whole range of metals such as gold, silver, platinum, titanium, palladium, copper, brass, aluminium and steel.
- Are very useful for getting into spherical awkward circular areas for example, inside rings and bangles
- Can be mounted onto pendant drill spindles in order to reach awkward areas
- Are superb to get an expert polish inside rings and bangles.
- Are a very economical and efficient method for batch work.

**Recommend compounds**

- P1388 Dialux Rouge
- P7809 Platinum Final Finish Polinum Polishing Compound
- P1394 Hyfin Final Finish Compound
- P1410 Tripoli General Purpose Polishing Compound

Code	Description	UOM	Price
P40230	Ø25 x 25mm Cylinder	EACH	£0.60
P40231	Ø40 x 40mm Cylinder	EACH	£1.75
Price breaks available, see website			

### Tapered Cone



Tapered gives you the ability to polish many sizes.

Code	Description	UOM	Price
P1281	Ø22 x 90 x Ø15mm, A*F Swiss	EACH	£8.10
P3539	Ø25 x 50 x Ø12mm, UK Made	EACH	£3.30
P3537	Ø25 x 56 x Ø12mm, UK Made	EACH	£3.85
P3538	Ø25 x 100 x Ø12mm, UK Made	EACH	£7.95
Price breaks available, see website			

### Tapered Cone, Mounted



Mounted with Wooden Centre

Favourite for wedding ring inside polishing.

Both P3534 and P3535 have a metal support ring on the base strengthens the cone when winding onto the spindle. Due to this reinforced centre, one can appreciate this type of inside felt is long lasting.

Code	Description	UOM	Price
P3534	Ø25mm x 55mm x Ø12mm Mounted Felt Cone	EACH	£4.70
P3535	Ø25mm x 80mm x Ø12mm Mounted Felt Cone	EACH	£4.95
Price breaks available, see website			

### Tapered Cone & Wheel



With Wooden Centre for the fast and speedy jobber or repairer jeweller. These are excellent 2 in 1 felt, inside & outside ring polishing buffs.

- Simply just wind on to your tapered polishing spindle
- Mounted on a wooden hub
- White felt
- Dimensions: Felt cone length x wheel diameter

**P35539:**

- 75mm taper felt cone, from Ø25 to Ø12mm
- Felt wheel secured on wooden back, Ø60 x 12mm thick
- Made in UK

**P39317:**

- 75mm taper felt cone, from Ø20 to Ø15mm
- Felt wheel secured on wooden back, Ø50 x 12mm thick
- Made in India

**P39316**

- 100mm taper felt cone, from Ø22 to Ø16mm
- Felt wheel secured on wooden back, Ø50 x 12mm thick
- Made in India

Code	Description	UOM	Price
P39317	75mm x Ø50mm Combination Felt	EACH	£3.95
P35539	75mm x Ø60mm Combination Felt, UK Made	EACH	£6.50
P39318	100mm x Ø50mm Combination Felt	EACH	£4.95

## FELT WHEELS



Felt wheels have excellent resilience and last longer when in use. Used with the appropriate compounds you can get a high standard, semi-bright, and mirror finish.

**Felt Wheels:**

- are very popular for jewellers, silversmiths, light engineers, model makers and those in arts and crafts.
- can be used on a whole range of metals such as gold, silver, platinum, titanium, palladium, copper, brass, aluminium and steel.
- Smaller size felt wheels are very useful for getting into spherical awkward circular areas for example, inside bangles.
- Larger felts are commonly used to polish flat

plain items (on the side of the mop) such as signet rings, cufflinks and tie pins.

- are a very economical and efficient method for batch work.
- hold their shape very well, pushing hard against the piece(s) applying pressure gives a fast and effective polish.
- are ideal for levelling metal such as smoothing out scratches, pit holes, file and casting flash marks.

**Recommend compounds**

- P1388 Dialux Rouge
- P7809 Platinum Final Finish Polinum Polishing Compound
- P1394 Hyfin Final Finish Compound
- P1410 Tripoli General Purpose Polishing Compound

### Felt Wheels



- White Felt
- High mirror finish
- Various diameters & thickness
- Lead hole
- Made in India

Code	Description	UOM	Price
P39311	Ø50 x 10mm Felt Wheel	EACH	£1.75
P39312	Ø100 x 15mm Felt Wheel	EACH	£3.95

### Felt Wheels, Made in UK



High Mirror Finish - Flat Lapping or Ring Shanks etc.

- White Felt
- Grades: Soft, Medium & Hard Felt
- Various diameters & thickness
- Lead hole
- Made in UK

Code	Description	UOM	Price
P3545	Ø50 x 12mm Hard Felt Wheel	EACH	£1.95
P3544	Ø75 x 12mm Hard Felt Wheel	EACH	£4.10
P3543	Ø75 x 25mm Hard Felt Wheel	EACH	£6.95
P4615	Ø100 x 12mm Medium Felt Wheel	EACH	£5.75
P4614	Ø100 x 25mm Medium Felt Wheel	EACH	£8.50
P1279	Ø120 x 25mm Hard Felt Wheel, Bergeon 2267	EACH	£36.35
P3575A	Ø150 x 12mm Soft Felt Wheel	EACH	£9.50
P4616	Ø150 x 12mm Medium Felt Wheel	EACH	£10.85
P4613	Ø150 x 25mm Medium Felt Wheel	EACH	£15.95
P3576C	Ø150 x 25mm Hard Felt Wheel	EACH	£17.95
Price breaks available, see website			



**SAME DAY DISPATCH**

## Felt Wheels with Wooden Hub

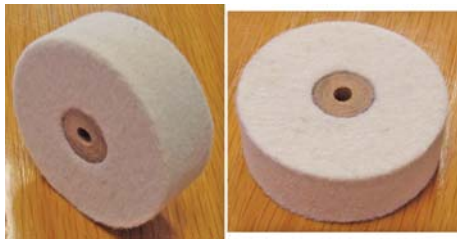

- Bergeon 1197
- Dimensions Ø60 x 20 x 5mm (lead hole)
- White hard Felt
- Wooden Centre

Code	Description	UOM	Price
<b>P1278</b>	Wooden Hub Felt Wheel	EACH	<b>£17.85</b>
Price breaks available, see website			

## Knife Edge Felt Wheels



Tapered edges which are idea for polishing joins, seams & crevices

- Various Dimensions
- Pin Hole Centres
- White Felt
- "Nick bob" Knife Edge Felt
- Made in India

Code	Description	UOM	Price
<b>P39301</b>	Ø35mm Felt Wheel - Knife edge	EACH	<b>£1.65</b>
<b>P39302</b>	Ø50mm Felt Wheel - Knife edge	EACH	<b>£2.20</b>
<b>P39303</b>	Ø65mm Felt Wheel - Knife edge	EACH	<b>£2.95</b>
<b>P39304</b>	Ø75mm Felt Wheel - Knife edge	EACH	<b>£3.80</b>
<b>P39305</b>	Ø100mm Felt Wheel - Knife edge	EACH	<b>£5.55</b>
<b>P39306</b>	Ø125mm Felt Wheel - Knife edge	EACH	<b>£7.50</b>
<b>P39307</b>	Ø150mm Felt Wheel - Knife edge	EACH	<b>£13.95</b>

## Knife Edge Felt Wheels, Superior

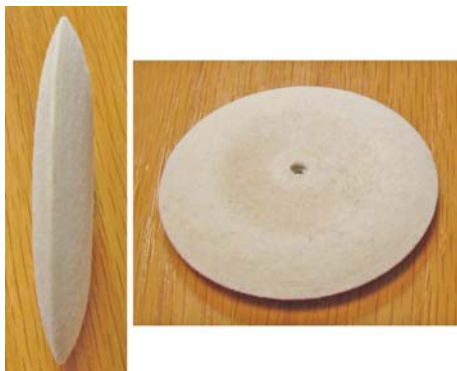

- Dimensions Ø75 x 10mm
- White hard Felt
- "nick bob" Knife Edge Felt

Code	Description	UOM	Price
<b>P3536</b>	Ø75mm Felt Wheel - Knife Edge	EACH	<b>£4.60</b>
Price breaks available, see website			

## Bevelled Edge Felt Wheels

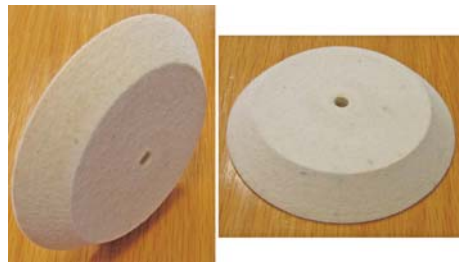

For greater precision polishing

- Dimensions Ø100 x 15mm
- White Hard Felt

Code	Description	UOM	Price
<b>P3546</b>	100 x 15mm Bevelled Hard Felt Wheel	EACH	<b>£7.95</b>
Price breaks available, see website			

## STONE WHEELS

### Wheels - Grinding Wheel Ø75mm



On many occasions, as watch repairers we face the challenge of changing a watch glass into a shape which is not available as a standard glass. We have a particular abrasive grinding wheel to combat this problem made from Norton, the world market leader for abrasives.

Simply mark your glass with a permanent or china graph marker to the desired shape, dunk it in some water, come up to the stone and start trimming. Repeat the process until you see your mineral glass forming to the shape you desire.

Please note to play it safe with grinding wheels:

1. Do not wind on to your polishing taper spindle
2. Do not exceed the operating speed 33/m5
3. Mount on to a guard protected grinding machine
4. Wear necessary safety equipment

Dimensions:

- S34923: 150 x 13mm, with 31.75mm spindle hole without nylon bushes, 19mm with nylon bushes fitted
- S39027: 100 x 13mm, with 31.75mm spindle hole without nylon bushes, 12.75mm with nylon bushes fitted

Code	Description	UOM	Price
<b>S39027</b>	Ø100 x 13mm Grinding Wheel	EACH	<b>£5.95</b>
<b>S34923</b>	Ø150 x 13mm Grinding Wheel	EACH	<b>£9.95</b>

### Wheel Mandrels & Taper Spindles

See Page 713



### Kronoglass Glass Cutting Machine

See Page 671



## MANHATTAN WHEELS

### Manhattan Wheels



Reducing - Graining - Polishing - especially watch bracelets

MANHATTAN has been reliably supplying the manufacturing industry with rubber-bonded products for graining and polishing since 1963.

For four decades Manhattan has been a world favourite for incomparable precise speed and flexibility. CousinsUK are pleased to offer Manhattan Wheels as used by "The Top Swiss Watch Houses" to refinish cases.

- Comprising excellent cutting ability for stainless steel
- Leaves a light satin finish ready for graining or polishing
- Reshape with ease: while rotating push against the wheel with a Flat Scraper (code S33507) and reshape and contour to manipulate the preferred surface
- To get the best results for watch work use at speed 1400rpm

Weights:

P33577 - 115g  
P33576 - 225g

Note: These wheels cut stainless steel with ease so use with care on all metals.

Code	Description	UOM	Price
<b>P33577</b>	Grit 180, Ø75mm x 10mm Manhattan Wheel	EACH	<b>£12.95</b>
<b>P33576</b>	Grit 240, Ø100mm x 12mm Manhattan Wheel	EACH	<b>£25.95</b>

## MOPS - COTTON END

### Cotton End Mops



1st stage: scratches of metal brighten to mirror finish  
Riva Bottom End Mop (M5614)

This mop has a fine tight cloth weave

- Mill treated, hard 100% pure cotton, similar to 'g' quality.

- Enhances cut without loss of head retention
- Leather and fibril centres
- The most Popular starting mop in the polishing industry
- A medium grade of loose fold mop
- Also known in the trade as a grease buffing mop
- When you use Riva Bottom End mops it holds its shape very well, and you can push up your pieces to get into those awkward areas.
- An ideal mop to level your metal such as scratches, pit holes, file and casting flash marks.
- A very popular end mop used to get into tankards, vases, trophies, silver/gold boxes and spoons.
- Manufactured in Great Britain

The Riva Bottom End Mop mops has very good wear and last longer when in use.

Very good to do large batch loads of work with economical spending.

Used with the right bar of compounds you can get a high standard semi bright finish.

Code	Description	UOM	Price
M5614	Polishing Bottom Mop	EACH	£21.55
Price breaks available, see website			

## MOPS - DOLLY



Cousins UK - UK Made

Dolly mops are very useful to get into spherical awkward circular areas including internal polishing of tankards, bangles etc.

Stage 1:

Sisal, starting mops for cutting & removing Coarse Scratch Marks with the following recommended compounds:

- P1393 Steelcut Coarse Cutting
- P1392 Carbrax Coarse Cutting
- P3666 Ferrobrite 3050 Coarse Cutting
- P3667 Ferrobrite 4040 Coarse Cutting
- P3668 Ferrobrite 2464 Coarse Cutting

Stage 2:

Aurelia & Riva, medium mops for cleaning & removing scratch marks with the following recommended compounds:

- P1410 Tripoli General Purpose
- P1384 Dialux blue
- P1394 Hyfin

Stage 3:

Swansdown, fine finishing mops for buffing to a mirror finish with the following recommended compounds:

- P1388 Dialux Rouge
- P1397 A A rouge
- P3659 Britelea ff9
- P7809 Polinum
- P7809A Platinum Superior Final Finish

Sizes:

½" = 12.7mm, 1" = 25.4mm, 1½" = 38.1mm  
2" = 50.8mm, 2½" = 63.5mm

## 1st Stage Polishing (Sisal)



Cousins UK - UK Made - Sisal Dolly Mops

For course cutting semi bright finishing - 1st Stage

- The Sisal dolly mops are a made form natural material.
- Sisal comes from a plant grown in far east and South America
- Speedy fast cutting beginning stage polishing mop.
- Removing deep pit holes casting flash marks.
- Every Sisal Dolly section is manufactured with averagely 5 layers of best quality material.
- Every section is separated by a layer of calico cotton.
- You will not find alternative materials used to fill these mops.
- Chemical treated for hardest and compound retention (lasts longer).
- Sisal Dolly mops are used on non precious metals.
- Some popular metals sisals can be used on are brass, copper, cast iron, steel, and pewter.

If you would like to see what sort of finish sisal mops do look at your domestic tool box.

Notice spanners hammers and grip pliers how they are shiny and even on their finish.

These are finished with sisal mops.

The Sisal mops has very good wear and last longer when in use.

Very good to do large batch loads of work with economical spending.

Used with the right bar of compounds you can get a high standard semi bright finish.

Sizes :

4mm Bore

Material thickness .34mm

Sisal layers size 2.25mm

Six stitches per 1" inch

Code	Description	UOM	Price
P3571A	Ø1" x ½" Sisal	EACH	£2.65
P3571C	Ø1½" x 1" Sisal	EACH	£3.05
P3571D	Ø2" x ½" Sisal	EACH	£2.95
P3571E	Ø2" x 1" Sisal	EACH	£3.65
P3571F	Ø2½" x ½" Sisal	EACH	£3.50
P3571G	Ø2½" x 1" Sisal	EACH	£4.05
Price breaks available, see website			

## 2nd Stage Polishing (Aurelia)



Cousins UK - UK Made - Aurelia (B Calico) Dolly Mop

For cleaning & removing medium/course scratch marks - 2nd Stage

This mop has a normal cloth weave

- Mill treated, hard 100% pure cotton, similar to 'b' quality.

- Enhances cut without loss of head retention
- Two centre rows of stitching around centre strengthens centre
- Popular starting mop
- A medium grade of loose fold mop
- Also known in the trade as a buffing mop
- When you use Aurelia (B Calico) Dolly Mop mops it holds its shape very well, and you can push up your pieces to get into those awkward areas.
- An ideal mop to level your metal such as scratches, pit holes, file and casting flash marks.
- Most popular with getting inside polishing bangles, and bracelets.

The Aurelia mops has very good wear and last longer when in use.

Very good to do large batch loads of work with economical spending.

Used with the right bar of compounds you can get a high standard semi bright finish.

Size:

- Material thickness .38mm (per fold)
- Centre bore size 4mm

Code	Description	UOM	Price
P3573A	Ø1" x ½" Aurelia	EACH	£2.30
P3573B	Ø1" x 1" Aurelia	EACH	£2.30
P3573C	Ø1½" x ½" Aurelia	EACH	£2.30
P3573D	Ø1½" x 1" Aurelia	EACH	£2.30
P3573E	Ø2" x ½" Aurelia	EACH	£2.75
P3573F	Ø2" x 1" Aurelia	EACH	£3.00
P3573G	Ø2½" x ½" Aurelia	EACH	£3.90
P3573H	Ø2½" x 1" Aurelia	EACH	£3.90
Price breaks available, see website			

## 2nd Stage Polishing (Riva)



Cousins UK - UK Made - Riva (G Quality) Dolly Mop

For cleaning & removing medium scratch marks - 2nd Stage

This mop has a fine tight cloth weave

- Mill treated, hard 100% pure cotton, similar to 'g' quality.

- Enhances cut without loss of head retention
- The most Popular starting mop in the polishing industry

- A medium grade of loose fold mop
- Two centre rows of stitching around centre strengthens centre
- Also known in the trade as a grease buffing mop
- When you use Riva Dolly Mops it holds its shape very well, and you can push up your pieces to get into those awkward areas.
- An ideal mop to level your metal such as scratches, pit holes, file and casting flash marks.
- Most popular with getting inside polishing bangles, and bracelets.

The Riva Dolly Mops has very good wear and last longer when in use.

Very good to do large batch loads of work with economical spending.

Used with the right bar of compounds you can get a high standard semi bright finish.

Size:

- Material thickness .24mm (per fold)
- Centre bore size 4m

Code	Description	UOM	Price
P3572A	Ø1" x ½" Riva	EACH	£2.25

PRICE PROMISE  
GUARANTEE



P3572B	Ø1" x 1" Riva	EACH	£2.30
P3572C	Ø1½" x ½" Riva	EACH	£2.30
P3572D	Ø1½" x 1" Riva	EACH	£2.30
P3572E	Ø2" x ½" Riva	EACH	£2.55
P3572F	Ø2" x 1" Riva	EACH	£2.85
P3572G	Ø2½" x ½" Riva	EACH	£3.75
P3572H	Ø2½" x 1" Riva	EACH	£4.85

Price breaks available, see website

## 3rd Stage Polishing (Swansdown)



Cousins UK - UK Made - Swansdown Dolly Mops

For buffing/mirror final finish - 3rd Stage

Swansdown Dolly Mops (Similar to both Felpato and 'S' quality, 100% pure cotton for final finishing).

- Medium cloth weave for a final finishing mop
- Mill treated, hard 100% pure cotton, similar to 'r' quality.
- Enhances a fine mirror finish without loss of head retention
- Two centre rows of stitching around centre strengthens centre
- One of the most popular finishing mops in the polishing industry
- A fine grade of loose fold mop
- Also known in the trade as a mirroring quality mop
- An ideal mop get the expert finishing mirror shine on your work.
- Most popular with getting inside polishing bangles, and bracelets.

When you use Swansdown Dolly mops it holds its shape very well, and you can push up your pieces to get into those awkward areas.

You will find the mop maintains durability whilst still offering a quality high final finish.

The Swansdown mops are resilient when in use. Swansdown is ideal for large quantities of work with economical spending.

Used with the right bar of compounds you can get a high standard mirror finish.

Size:

- Material thickness .32mm (per fold)
- Centre bore size 4mm

Code	Description	UOM	Price
P3574A	Ø1" x ½" Swansdown	EACH	£2.65
P3574B	Ø1" x 1" Swansdown	EACH	£2.65
P3574C	Ø1½" x ½" Swansdown	EACH	£2.65
P3574D	Ø1½" x 1" Swansdown	EACH	£2.65
P3574E	Ø2" x ½" Swansdown	EACH	£2.95
P3574F	Ø2" x 1" Swansdown	EACH	£3.50
P3574G	Ø2½" x ½" Swansdown	EACH	£3.80
P3574H	Ø2½" x 1" Swansdown	EACH	£4.80

Price breaks available, see website

## MOPS - LOOSE FOLD

Cousins UK - UK Made

Stage 1:

*Gialla Mops (F), starting mops for cutting & removing coarse scratch marks with the following recommended compounds:*

- P1394 hyfin

- P1392 carbrax
- P3668 ferrobrite 2464
- P3666 ferrobrite 3050

Stage 2:

*Aurelia Mops (B) & Riva Mops (G), medium mops for cleaning & removing scratch marks with the following recommended compounds:*

- P1410 Tripoli General Purpose Polishing Compound
- P1384 Dialux blue
- P1394 Hyfin

Stage 3:

*Madapolam Mops (R) & Swansdown Mops (S), fine finishing mops for buffing to a mirror finish with the following recommended compounds:*

- P1388 Dialux Rouge
- P1397 A A rouge
- P3659 Britelea ff9
- P7809 Polinum
- P7809A Platinum Superior Final Finish Polishing Compound

Stage 4:

*Felpato Mops (S) & Chamois Mops, extra fine finishing for buffing to a super mirror final finish with the following recommended compounds:*

*Recommend compounds*

- P1388 Dialux Rouge\*
- P1397 A A rouge
- P3659 Britelea ff9
- P7809 Polinum\*
- P7809A Platinum Superior Final Finish
- P1395 Vonax\*

Sizes:

½"(12.7mm) - 1"(25.4mm) - 1½"(38.1mm)  
2"(50.8mm) - 4"(101.6mm) - 6"(152.4mm)  
8"(203.2mm) - 10"(254mm)

## Gialla Mops (1st stage)



Cousins UK - UK Made - For cutting & removing course scratch marks - 1st stage

The Gialla ("F" Quality) mops has very good wear and last longer when in use. Very good to do large batch loads of work with economical spending. Used with the right bar of compounds you can get a high standard semi bright finish.

- Gialla is similar to 'F' quality
- Mill treated, hard 100% pure cotton
- Enhances cut without loss of head retention
- Leather and fibril centres
- Popular fast cutting starting mop
- A hard grade of loose fold mop
- Also known in the trade as a flap mop
- When you use Gialla mops it holds its shape very well
- An ideal mop to level your metal such as scratches, pit holes, file and casting flash marks
- Manufactured in Great Britain

Size:

- Material thickness .38mm (per fold)

- Centre bore size 9mm

Dimension: Outside Ø x Width x Folds (70 folds per inch face)

Code	Description	UOM	Price
P3625A	4" x ½" Gialla, 35 fold	EACH	£5.30
P3625B	4" x 1" Gialla, 70 fold	EACH	£8.40
P3625C	4" x 1½" Gialla, 105 fold	EACH	£11.55
P3625D	4" x 2" Gialla, fold 140	EACH	£14.35
P3625E	6" x ½" Gialla, 35 fold	EACH	£7.15
P3625F	6" x 1" Gialla, 70 fold	EACH	£12.35
P3625G	6" x 1½" Gialla, 105 fold	EACH	£17.90
P3625H	6" x 2" Gialla, 140 fold	EACH	£22.74
P3625I	8" x ½" Gialla, 35 fold	EACH	£13.40
P3625J	8" x 1" Gialla, 70 fold	EACH	£21.50
P3625K	8" x 1½" Gialla, 105 fold	EACH	£29.55
P3625L	8" x 2" Gialla, 140 fold	EACH	£37.60
P3625M	10" x ½" Gialla, 35 fold	EACH	£20.54
P3625N	10" x 1" Gialla, 70 fold	EACH	£32.90
P3625O	10" x 1½" Gialla, 105 fold	EACH	£45.25
P3625P	10" x 2" Gialla, 140 fold	EACH	£57.60

Price breaks available, see website

## Aurelia Mops (2nd stage)



Cousins UK - UK Made - For cleaning & removing scratch marks - 2nd stage

The Aurelia (Calico) mops has very good wear and last longer when in use. Very good to do large batch loads of work with economical spending. Used with the right bar of compounds you can get a high standard semi bright finish.

- Aurelia (Calico) is similar to 'B' quality
- This mop has a normal cloth weave
- Mill treated, hard 100% pure cotton
- Enhances cut without loss of head retention
- Leather and fibril centres
- Popular starting mop
- A medium grade of loose fold mop
- Also known in the trade as a buffing mop
- When you use Aurelia mops it holds its shape very well
- You can push up your pieces to get into those awkward areas
- An ideal mop to level your metal such as scratches, pit holes, file and casting flash marks
- Manufactured in Great Britain

Size:

- Material thickness .38mm (per fold)
- Centre bore size 9mm

Dimension: Outside Ø x Width x Folds (56 folds per inch face).

Code	Description	UOM	Price
P3626A	4" x ½" Aurelia (Calico) 28 fold	EACH	£4.30
P3626B	4" x 1" Aurelia (Calico) 56 fold	EACH	£6.25
P3626C	4" x 1½" Aurelia (Calico) 84 fold	EACH	£7.55
P3626D	4" x 2" Aurelia (Calico) 112 fold	EACH	£9.85
P3626E	6" x ½" Aurelia (Calico) 28 fold	EACH	£6.25
P3626F	6" x 1" Aurelia (Calico) 56 fold	EACH	£7.75
P3626G	6" x 1½" Aurelia (Calico) 84 fold	EACH	£13.50
P3626H	6" x 2" Aurelia (Calico) 112 fold	EACH	£15.65
P3626I	8" x ½" Aurelia (Calico) 28 fold	EACH	£7.55
P3626J	8" x 1" Aurelia (Calico) 56 fold	EACH	£12.75

<b>P3626K</b>	8" x 1½" Aurelia (Calico) 84 fold	EACH	<b>£17.95</b>
<b>P3626L</b>	8" x 2" Aurelia (Calico) 112 fold	EACH	<b>£23.15</b>
<b>P3626M</b>	10" x ½" Aurelia (Calico) 28 fold	EACH	<b>£12.70</b>
<b>P3626N</b>	10" x 1" Aurelia (Calico) 56 fold	EACH	<b>£19.25</b>
<b>P3626O</b>	10" x 1½" Aurelia (Calico) 84 fold	EACH	<b>£26.10</b>
Price breaks available, see website			

**Riva Mops (2nd stage)**



Cousins UK - UK Made - For cleaning & removing scratch marks - 2nd stage

The Riva (Calico) mops has very good wear and last longer when in use. Very good to do large batch loads of work with economical spending. Used with the right bar of compounds you can get a high standard semi bright finish.

- Riva (Calico) is similar to 'G' quality
- This mop has a fine tight cloth weave
- Mill treated, hard 100% pure cotton
- Enhances cut without loss of head retention
- Leather and fibril centres
- The most popular starting mop in the polishing industry
- A medium grade of loose fold mop
- Also known in the trade as a grease buffing mop
- When you use Riva mops it holds its shape very well
- You can push up your pieces to get into those awkward areas
- An ideal mop to level your metal such as scratches, pit holes, file and casting flash marks
- Manufactured in Great Britain

Size:

- Material thickness .24mm (per fold)
- Centre bore size 9mm

Dimension: Outside Ø x Width x Folds (70 folds per inch face).

Code	Description	UOM	Price
<b>P3627A</b>	4" x ½" Riva (Calico) 35 fold	EACH	<b>£4.20</b>
<b>P3627B</b>	4" x 1" Riva (Calico) 70 fold	EACH	<b>£6.60</b>
<b>P3627C</b>	4" x 1½" Riva (Calico) 105 fold	EACH	<b>£7.85</b>
<b>P3627E</b>	6" x ½" Riva (Calico) 35 fold	EACH	<b>£6.00</b>
<b>P3627F</b>	6" x 1" Riva (Calico) 70 fold	EACH	<b>£10.10</b>
<b>P3627G</b>	6" x 1½" Riva (Calico) 105 fold	EACH	<b>£12.65</b>
<b>P3627H</b>	6" x 2" Riva (Calico) 140 fold	EACH	<b>£13.50</b>
<b>P3627I</b>	8" x ½" Riva (Calico) 35 fold	EACH	<b>£6.50</b>
<b>P3627J</b>	8" x 1" Riva (Calico) 70 fold	EACH	<b>£13.75</b>
<b>P3627K</b>	8" x 1½" Riva (Calico) 105 fold	EACH	<b>£19.45</b>
<b>P3627L</b>	8" x 2" Riva (Calico) 140 fold	EACH	<b>£25.15</b>
<b>P3627M</b>	10" x ½" Riva (Calico) 35 fold	EACH	<b>£10.15</b>
<b>P3627N</b>	10" x 1" Riva (Calico) 70 fold	EACH	<b>£20.30</b>
<b>P3627O</b>	10" x 1½" Riva (Calico) 105 fold	EACH	<b>£29.30</b>
<b>P3627P</b>	10" x 2" Riva (Calico) 140 fold	EACH	<b>£38.30</b>
Price breaks available, see website			

**PRICE PROMISE GUARANTEE** ✓

**Madapolam Mops (3rd stage)**



Cousins UK - UK Made - For buffing to a mirror finish - 3rd stage

The Madapolam mops are resilient when in use. Madapolam is ideal for large quantities of work with economical spending. Used with the right bar of compounds you can get a high standard bright finish.

- Madapolam is similar to 'R' quality
- This mop has a fine tight cloth weave
- Madapolam Mop, an intermediate grade between Calico and Swansdown
- Mill treated, hard 100% pure cotton
- Enhances a fine mirror finish without loss of head retention
- Leather and fibril centres
- One of the most popular finishing mops in the polishing industry
- A fine grade of loose fold mop
- Also known in the trade as a Reflex quality mop
- When you use Madapolam mops it holds its shape very well
- You can push up your pieces to get into those awkward areas
- An ideal mop get the expert finishing mirror shine on your work
- Manufactured in Great Britain

Size:

- Material thickness .32mm (per fold)
- Centre bore size 9mm. Similar to "R" quality.

Dimension: Outside Ø x Width x Folds (60 folds per inch face).

Code	Description	UOM	Price
<b>P3630A</b>	4" x ½" Madapolam, 30 fold	EACH	<b>£5.30</b>
<b>P3630B</b>	4" x 1" Madapolam, 60 fold	EACH	<b>£6.45</b>
<b>P3630C</b>	4" x 1½" Madapolam, 90 fold	EACH	<b>£9.15</b>
<b>P3630D</b>	4" x 2" Madapolam, 120 fold	EACH	<b>£11.25</b>
<b>P3630E</b>	5" x ½" Madapolam, 30 fold	EACH	<b>£5.85</b>
<b>P3630F</b>	5" x 1" Madapolam, 60 fold	EACH	<b>£8.25</b>
<b>P3630G</b>	5" x 1½" Madapolam, 90 fold	EACH	<b>£10.40</b>
<b>P3630H</b>	5" x 2" Madapolam, 120 fold	EACH	<b>£16.25</b>
<b>P3630I</b>	6" x ½" Madapolam, 30 fold	EACH	<b>£6.75</b>
<b>P3630J</b>	6" x 1" Madapolam, 60 fold	EACH	<b>£13.65</b>
<b>P3630K</b>	6" x 1½" Madapolam, 90 fold	EACH	<b>£15.95</b>
<b>P3630L</b>	6" x 2" Madapolam, 120 fold	EACH	<b>£16.95</b>
<b>P3630M</b>	8" x ½" Madapolam, 30 fold	EACH	<b>£7.50</b>
<b>P3630N</b>	8" x 1" Madapolam, 60 fold	EACH	<b>£15.30</b>
<b>P3630O</b>	8" x 1½" Madapolam, 90 fold	EACH	<b>£21.30</b>
<b>P3630P</b>	8" x 2" Madapolam, 120 fold	EACH	<b>£37.50</b>
Price breaks available, see website			

**TODAY SAME DAY DISPATCH**

**Bergeon Polishing Motors**



See Page 708

**Swansdown Mops (3rd stage)**



Cousins UK - UK Made - For buffing to a mirror finish - 3rd stage

The Swansdown mops are resilient when in use. Swansdown is ideal for large quantities of work with economical spending. Used with the right bar of compounds you can get a high standard mirror finish.

- Swansdown is similar to both Felpato and 'S' quality
- 100% pure cotton for final finishing
- This mop has a medium cloth weave
- Swansdown is a final finishing mop
- Mill treated, hard 100% pure cotton
- Enhances a fine mirror finish without loss of head retention
- Leather and fibril centres
- One of the most popular finishing mops in the polishing industry
- A fine grade of loose fold mop
- Also known in the trade as a mirroring quality mop
- An ideal mop get the expert finishing mirror shine on your work
- Manufactured in Great Britain

Size:

- Material thickness .32mm (per fold)
- Centre bore size 9mm

Dimension: Outside Ø x Width x Folds (44 folds per inch face).

Code	Description	UOM	Price
<b>P3628A</b>	4" x ½" Swansdown, 22 fold	EACH	<b>£3.75</b>
<b>P3628B</b>	4" x 1" Swansdown, 44 fold	EACH	<b>£6.35</b>
<b>P3628C</b>	4" x 1½" Swansdown, 66 fold	EACH	<b>£9.30</b>
<b>P3628D</b>	4" x 2" Swansdown, 88 fold	EACH	<b>£12.75</b>
<b>P3628E</b>	5" x ½" Swansdown, 22 fold	EACH	<b>£4.40</b>
<b>P3628F</b>	5" x 1" Swansdown, 44 fold	EACH	<b>£7.85</b>
<b>P3628G</b>	5" x 1½" Swansdown, 66 fold	EACH	<b>£11.65</b>
<b>P3628H</b>	5" x 2" Swansdown, 88 fold	EACH	<b>£13.65</b>
<b>P3628I</b>	6" x ½" Swansdown, 22 fold	EACH	<b>£5.25</b>
<b>P3628J</b>	6" x 1" Swansdown, 44 fold	EACH	<b>£8.95</b>
<b>P3628K</b>	6" x 1½" Swansdown, 66 fold	EACH	<b>£12.25</b>
<b>P3628L</b>	6" x 2" Swansdown, 88 fold	EACH	<b>£11.70</b>
<b>P19135</b>	6" x 3" Swansdown, 132 fold	EACH	<b>£19.55</b>
<b>P3628M</b>	8" x ½" Swansdown, 22 fold	EACH	<b>£7.10</b>
<b>P3628N</b>	8" x 1" Swansdown, 44 fold	EACH	<b>£12.55</b>
<b>P3628O</b>	8" x 1½" Swansdown, 66 fold	EACH	<b>£17.45</b>
<b>P3628P</b>	8" x 2" Swansdown, 88 fold	EACH	<b>£22.85</b>
Price breaks available, see website			

**OVER 130,000 DIFFERENT ITEMS**

**Menzerna, Final Finish Polish**



See Page 1174



Felpato Mops (4th stage)



Cousins UK - UK Made - For buffing to a super mirror final finish - 4th stage

The Felpato mops are resilient when in use. Felpato is ideal for large quantities of work with economical spending. Used with the right bar of compounds you can get a very high standard mirror finish.

- Felpato is similar to 'S' quality
- 100% pure cotton, excellent for finishing
- This mop has a medium cloth weave
- Felpato is a final finishing mop
- Use this mop after a Swansdown or a Madapolam mop to brighten your final finish
- Obtain a very high grade of mirror finishing
- Mill treated, hard 100% pure cotton
- Enhances a fine mirror finish without loss of head retention
- Leather and fibril centres
- One of the most popular final finishing mops in the polishing industry
- A fine grade of loose fold mop
- Also known in the trade as a mirroring quality mop
- An ideal mop get the expert finishing mirror shine on your work
- Manufactured in Great Britain

Size:

- Material thickness .48mm (per fold)
- Centre bore size 9mm

Dimension: Outside Ø x Width x Folds (30 folds per inch face).

Code	Description	UOM	Price
P3629A	4" x ½" Felpato, 15 fold	EACH	£5.10
P3629B	4" x 1" Felpato, 30 fold	EACH	£6.95
P3629C	4" x 1½" Felpato, 45 fold	EACH	£8.40
P3629D	4" x 2" Felpato, 60 fold	EACH	£11.35
P3629E	5" x ½" Felpato, 15 fold	EACH	£4.95
P3629F	5" x 1" Felpato, 30 fold	EACH	£8.75
P3629G	5" x 1½" Felpato, 45 fold	EACH	£8.80
P3629H	5" x 2" Felpato, 60 fold	EACH	£12.10
P3629I	6" x ½" Felpato, 15 fold	EACH	£6.85
P3629J	6" x 1" Felpato, 30 fold	EACH	£7.75
P3629K	6" x 1½" Felpato, 45 fold	EACH	£11.95
P3629L	6" x 2" Felpato, 60 fold	EACH	£14.50
P3629M	8" x ½" Felpato, 15 fold	EACH	£7.65
P3629N	8" x 1" Felpato, 30 fold	EACH	£9.95
P3629O	8" x 1½" Felpato, 45 fold	EACH	£13.95
P3629P	8" x 2" Felpato, 60 fold	EACH	£19.95
P3629Q	10" x ½" Felpato, 15 fold	EACH	£11.08
P3629R	10" x 1" Felpato, 30 fold	EACH	£22.15
P3629S	10" x 1½" Felpato, 45 fold	EACH	£24.95
P3629T	10" x 2" Felpato, 60 fold	EACH	£34.95

Price breaks available, see website

Chamois Mops (4th stage)



Cousins UK - UK Made - For buffing to a super mirror final finish - 4th stage

The chamois leather mops have excellent durability and are ideal for batch work, economically. Furthermore, using these mops with the below compounds you can achieve a high standard mirror finish. Gives a very traditional superior mirror finish to the contemporary mop, use the mop wet with rouge powder (P8984) for gold and silver!

- 100% best grade buffalo hide leather
- Very popular finishing mop in the polishing industry
- These mops hold their shape well
- Also known in the trade as a mirroring quality mop
- Very popular for jewellers, silversmiths, clock makers/repairers & plastic fabricators etc.
- Can used on a whole range of materials such as gold, silver, copper, brass, pewter, prosthetic plastics and steel
- Max R.P.M 2,500 - 3,000
- Manufactured in Great Britain

Code	Description	UOM	Price
M41196	Ø75mm Chamois Mop	EACH	£4.75

Price breaks available, see website

MOPS - STITCHED

Cousins UK - UK Made

Stage 1:

Sisal (AA), starting mops for cutting & removing coarse scratch marks with the following recommended compounds:

- P1393 Steelcut Coarse Cutting
- P1392 Carbrax Coarse Cutting
- P3666 Ferrobrite 3050 Coarse Cutting
- P3667 Ferrobrite 4040 Coarse Cutting
- P3668 Ferrobrite 2464 Coarse Cutting

Stage 2:

Calico & Coloured Stitch, medium mops for cutting & removing coarse marks with the following recommended compounds:

- P1394 hyfin
- P1392 carbrax
- P3668 ferrobrite 2464
- P1386 Dialux Grey Final Finish

Stage 3:

White Calico, fine finishing mops for buffing to a mirror finish with the following recommended compounds:

- P1394 Hyfin
- P1410 Tripoli General Purpose
- P1396 Radio Rouge Final Finish
- P1396 AA Rouge Final Finish

Sizes:

½"(12.7mm) - 1"(25.4mm) - 1½"(38.1mm)  
2"(50.8mm) - 4"(101.6mm) - 6"(152.4mm)  
8"(203.2mm) - 10"(254mm)

Sisal AA Dry (1st stage)



Cousins UK - UK Made - For cutting & removing coarse scratch marks - 1st stage

The Sisal mops has very good wear and last longer when in use. Very good to do large batch loads of work with economical spending. Used with the right bar of compounds you can get a high standard semi bright finish.

If you would like to see what sort of finish sisal mops do look at your domestic tool box. Notice spanners large hammers and grip pliers how they are shiny and even on their finish. These are finished with sisal mops.

- Made from natural material
- Sisal comes from a plant grown in far east and South America
- Speedy fast cutting beginning stage polishing mop
- Removes deep pit holes casting flash marks
- Every sisal section is manufactured with five layers of best quality material
- Every section is separated by a layer of calico cotton
- You will not find alternative materials used to fill these mops
- Chemical treated for hardest and compound retention (lasting longer)
- Sisal mops are used on non precious metals
- Some popular metals sisals can be used on are brass, copper, cast iron, steel, and pewter
- Manufactured in Great Britain

Sizes:

- Bore 9mm
- Material thickness 0.34mm
- Sisal layers size 2.25mm
- Six stitches per 1" inch

Dimension: outside Ø x Width (12mm per section).

Code	Description	UOM	Price
P3565A	4" x ½" Dry Sisal Mop	EACH	£3.50
P3565B	4" x 1" Dry Sisal Mop	EACH	£5.30
P3565C	4" x 1½" Dry Sisal Mop	EACH	£6.95
P3565D	4" x 2" Dry Sisal Mop	EACH	£8.75
P3565E	6" x ½" Dry Sisal Mop	EACH	£3.65
P3565F	6" x 1" Dry Sisal Mop	EACH	£5.85
P3565G	6" x 1½" Dry Sisal Mop	EACH	£7.65
P3565H	6" x 2" Dry Sisal Mop	EACH	£9.75
P3565I	8" x ½" Dry Sisal Mop	EACH	£4.10
P3565J	8" x 1" Dry Sisal Mop	EACH	£6.70
P3565K	8" x 1½" Dry Sisal Mop	EACH	£9.20
P3565L	8" x 2" Dry Sisal Mop	EACH	£11.70
P3565M	10" x ½" Dry Sisal Mop	EACH	£6.00
P3565N	10" x 1" Dry Sisal Mop	EACH	£9.15
P3565O	10" x 1½" Dry Sisal Mop	EACH	£13.50
P3565P	10" x 2" Dry Sisal Mop	EACH	£14.95
P3565Q	12" x ½" Dry Sisal Mop	EACH	£8.15
P3565R	12" x 1" Dry Sisal Mop	EACH	£12.35
P3565S	12" x 1½" Dry Sisal Mop	EACH	£14.95
P3565T	12" x 2" Dry Sisal Mop	EACH	£18.45

Price breaks available, see website



ONLINE ORDER STATUS

PRICE PROMISE GUARANTEE

**Calico Open Stitch (2nd stage)**



Cousins UK - Made in U.S.A. - For cutting & removing scratch marks - 2nd stage

The Calico stitched mops has very good wear and last longer when in use. Very good to do large batch loads of work with economical spending. Used with the right bar of compounds you can get a high standard semi bright finish. Very popular in the U.S.A.

- Mill treated, hard 100% pure cotton, similar to 'F' quality
- Enhances cut without loss of head retention
- Stitched with shellac and leather centre
- Popular fast cutting starting mop
- A hard grade of stitch fold mop
- Also known in the trade as a stitch flap mop
- When you use this stitched mop holds its shape very well
- An ideal mop to level your metal such as scratches, pit holes, file and casting flash marks
- Made in the U.S.A.

Size:

- Material thickness 0.32mm (per fold)
- Centre bore size 4mm
- 2 stitches per 1"

Code	Description	UOM	Price
P38458	3" x 30 Fold Calico	EACH	£1.30
P9571A	4" x 40 Fold Calico	EACH	£2.35
P38459	4" x 50 Fold Calico	EACH	£2.25
P38460	4" x 60 Fold Calico	EACH	£2.45
P38461	5" x 30 Fold Calico	EACH	£2.15
P9571B	5" x 40 Fold Calico	EACH	£2.50
P38462	5" x 50 Fold Calico	EACH	£2.55
P38463	5" x 60 Fold Calico	EACH	£2.75
P38467	6" x 12 Calico, Knife Edge	EACH	£1.95
P38464	6" x 30 Fold Calico	EACH	£2.35
P38465	6" x 40 Fold Calico	EACH	£2.65
P9571C	6" x 50 Fold Calico	EACH	£3.25
P38466	6" x 60 Fold Calico	EACH	£3.95

Price breaks available, see website

**Coloured Stitch Mop (2nd stage)**



Cousins UK - UK Made - For cutting & removing scratch marks - 2nd stage

Multipurpose cutting mops for a wide-range of first stage polishing to get the satisfactory semi-bright finish. They are used on metals such as copper, brass, pewter, bronze, and steel. If you would like to see what sort of finish coloured mops do look at your domestic every day items such as door handles fire places, old car bumpers and fixtures.

- Coloured mops are made from 100% recycled material
- They consist of denim and cotton compressed and put together by fine stitching
- In the image you will notice that the coloured mops have a flower pattern
- It might have been someone's curtain in a previous life; making it our greenest mop
- They have been used for generations in the polishing trade
- These mops have been primed and have leathers centres
- No staples have been used when manufacturing these mops, which makes them very robust
- The coloured mops have very good wear and last longer
- They are ideal for doing large batch loads of work with economical spending
- Used with the right bar of compounds you can get a high standard semi bright finish
- Stitch mops are flexible so you can push up against the piece to get into awkward areas
- The mop you will find will keep its shape well because of the close stitching
- Manufactured in Great Britain

Sizes:

- Bore 9mm Material
- Material thickness 0.30mm to 0.40mm
- Coloured layers 25 to 35 per 1" approx
- Very Close = 8 stitches per 1" inch
- Close = Six stitches per 1" inch
- Open = Two stitches per 1" inch

Dimension: outside Ø x Width (12 mm per section).

Code	Description	UOM	Price
P3636A	Very Close 4" x ½" Coloured Stitch	EACH	£2.75
P3636F	Very Close 6" x 1" Coloured Stitch	EACH	£5.75
P3636G	Very Close 6" x 1½" Coloured Stitch	EACH	£7.85
P3635B	Close 4" x 1" Coloured Stitch	EACH	£4.70
P3635E	Close 6" x ½" Coloured Stitch	EACH	£3.45
P3634A	Open 4" x ½" Coloured Stitch	EACH	£2.60
P3634B	Open 4" x 1" Coloured Stitch	EACH	£4.10
P3634J	Open 8" x 1" Coloured Stitch	EACH	£6.50

Price breaks available, see website

**White Calico, Close Stitch (3rd stage)**



Cousins UK - UK Made - For buffing & mirror final finish - 3rd stage

This is a mixture of Swansdown and Riva cotton layers. Which makes this mop a bit of a all-rounder (starting and finishing). If you flick the mop layers with your fingers you will notice white and brown cotton layers.

- White Close Stitch Calico Mop are made from 100% finest cotton
- They consist of finest grades of cotton compressed and put together by fine stitching
- They have been used for generations in the polishing trade
- They are used on metals such as gold, silver, copper, brass, pewter, bronze, and steel
- These mops have been primed and have leathers centres
- No staples have been used when manufacturing these mops, which makes them very robust
- The Close Stitch Calico Mop mops have very good wear and last longer
- The open stitch version is medium flexible so you can push up against the piece to get into awkward areas
- The mop you will find will keep its shape well because of the Close stitching
- Manufactured in Great Britain

Sizes:

- Bore 9mm Material
- Material thickness 0.3mm to 0.5mm
- Close Stitch Calico Mop layers 25 to 35 per 1" approx.
- Five stitches per 1" inch

Dimension: outside Ø x Width (12 mm section).

Code	Description	UOM	Price
P3632A	4" x ½" Close Stitch	EACH	£2.85
P3632B	4" x 1" Close Stitch	EACH	£4.30
P3632C	4" x 1½" Close Stitch	EACH	£6.50
P3632D	4" x 2" Close Stitch	EACH	£9.55
P3632E	6" x ½" Close Stitch	EACH	£3.45
P3632F	6" x 1" Close Stitch	EACH	£6.00
P3632G	6" x 1½" Close Stitch	EACH	£8.75
P3632H	6" x 2" Close Stitch	EACH	£10.45
P3632I	8" x ½" Close Stitch	EACH	£5.65
P3632J	8" x 1" Close Stitch	EACH	£10.15
P3632K	8" x 1½" Close Stitch	EACH	£14.75
P3632O	10" x 1½" Close Stitch	EACH	£16.15

Price breaks available, see website



**Mop Dressing Rake**

See Page 715



**Carlo De Georgi Polishing Motors**

See Page 708



**White Calico, Open Stitch (3rd stage)**



Cousins UK - UK Made - For buffing & mirror final finish - 3rd stage

This is a mixture of Swansdown and Riva cotton layers. Which makes this mop a bit of an all-rounder (starting and finishing). If you flick the mop layers with your fingers you will notice white and brown cotton layers.

- White Close Stitch Calico Mop are made from 100% finest cotton
- They consist of finest grades of cotton compressed and put together by fine stitching
- They have been used for generations in the polishing trade
- They are used on metals such as gold, silver, copper, brass, pewter, bronze, and steel
- These mops have been primed and have leathers centres
- No staples have been used when manufacturing these mops, which makes them very robust
- The Close Stitch Calico Mop mops have very good wear and last longer
- The Open stitch version is medium flexible so you can push up against the piece to get into awkward areas
- The mop you will find will keep its shape well because of the Close stitching
- Manufactured in Great Britain

Sizes:

- Bore 9mm Material
- Material thickness 0.3mm to 0.5mm
- Close Stitch Calico Mop layers 25 to 35 per 1" approx.
- Five stitches per 1" inch

Dimension: outside Ø x Width (12 mm section).

Code	Description	UOM	Price
P3631A	4" x ½" Open Stitch	EACH	£3.00
P3631B	4" x 1" Open Stitch	EACH	£4.60
P3631C	4" x 1½" Open Stitch	EACH	£5.95
P3631I	6" x ½" Open Stitch	EACH	£3.25
P3631J	6" x 1" Open Stitch	EACH	£6.20
P3631K	6" x 1½" Open Stitch	EACH	£8.65
P3631L	6" x 2" Open Stitch	EACH	£10.40
P3631M	8" x ½" Open Stitch	EACH	£5.30
P3631N	8" x 1" Open Stitch	EACH	£9.65
P3631O	8" x 1½" Open Stitch	EACH	£13.75
P3631S	10" x 1½" Open Stitch	EACH	£14.95

Price breaks available, see website

**White Calico, Very Close Stitch (3rd stage)**



Cousins UK - UK Made - For buffing & mirror final finish - 3rd stage

This is a mixture of Swansdown and Riva cotton layers. Which makes this mop a bit of an all-rounder (starting and finishing). If you flick the mop layers with your fingers you will notice white and brown cotton layers.

- White Close Stitch Calico Mop are made from 100% finest cotton
- They consist of finest grades of cotton compressed and put together by fine stitching
- They have been used for generations in the polishing trade
- They are used on metals such as gold, silver, copper, brass, pewter, bronze, and steel
- These mops have been primed and have leathers centres
- No staples have been used when manufacturing these mops, which makes them very robust
- The Close Stitch Calico Mop mops have very good wear and last longer
- The Close stitch version is medium flexible so you can push up against the piece to get into awkward areas
- The mop you will find will keep its shape well because of the Close stitching
- Manufactured in Great Britain

Sizes:

- Bore 9mm Material
- Material thickness 0.3mm to 0.5mm
- Close Stitch Calico Mop layers 25 to 35 per 1" approx.
- Five stitches per 1" inch

Dimension: outside Ø x Width (12 mm section).

Code	Description	UOM	Price
P3633B	4" x 1" Very Close Stitch	EACH	£4.65
P3633D	4" x 2" Very Close Stitch	EACH	£8.95
P3633E	6" x ½" Very Close Stitch	EACH	£3.65
P3633F	6" x 1" Very Close Stitch	EACH	£6.50
P3633H	6" x 2" Very Close Stitch	EACH	£11.25

Price breaks available, see website

**RUBBER (SYNTHETIC) AIRFLEX WHEELS**

**Rubber Air Wheel**



Eve rubber air wheels polish with an open porous structure allowing greater airflow during operation, reducing the friction heat

Great for:

- Precious metals (including alloys), including gold and silver
- Non precious metals (including alloys)
- Titanium
- Stainless steel
- Nickel
- Zirconium oxide

Grits:

- Fine Smoothing (Light Brown)
- Medium (Greenish Grey)
- Coarse Reducing (Light Blue)

Features:

- Ø100 x 15 x Ø6mm bore
- Composition: Synthetic rubber
- Recommended RPM: 3000RPM
- Open pore structure, allowing greater airflow during operation, reducing the friction heat
- Polishing wheels must always be flanged
- Long lasting
- They are easily profiled using conventional dressing tools
- No compounds needed, to be used dry

Mandrels:

- Screw on mandrels see code P1343M
- Threaded mandrels see code M4817

Code	Description	UOM	Price
P5086	Fine Smoothing (Light Brown)	EACH	£22.50
P5085	Medium (Greenish Grey)	EACH	£22.50
P5084	Coarse Reducing (Light Blue)	EACH	£22.50

Price breaks available, see website

**SILICON CARBIDE WHEEL (FOR A GRAINING EFFECT)**

**Silicon Carbide Graining Wheels**



Bergeon Swiss - Silicon Carbide Graining Wheels  
There are available in two types of rigidity, medium and soft.

- has a porous bonding giving the abrasive form great flexibility, guarantees cool (low heat) grinding effect, which prevents clogging of the piece under difficult working conditions.
- are very popular for watch makers/repairers, jewellers, silversmiths, light engineers, model makers and those in arts and crafts.
- can be used on a whole range of metals such as gold, silver, platinum, titanium, palladium, copper, brass, aluminium and steel.
- are fast cutting abrasive wheels prior to polishing/finishing.
- Removing deep pit holes, casting/flash marks.
- Very economical and efficient method for batch work.
- for graining, grinding, polishing, to satin, on all precious metal without polishing compounds.
- very popular for graining finish on watch cases and bracelets etc....

Specifications:

- Size Ø100 x 20 x 6mm bore
- Medium = 3900rpm
- Soft = 1900rpm
- Grain 150 or 240, higher the number the finer the grain

Code	Description	UOM	Price
P1271	150 Grain (Medium) Bergeon 6723.150.LP	EACH	£29.95
P1273	150 Grain (Soft) Bergeon 6723.150.GP	EACH	£29.95
P1272	240 Grain (Medium) Bergeon 6723.240.LP	EACH	£35.50
P1274	240 Grain (Soft) Bergeon 6723.240.GP	EACH	£35.50

Price breaks available, see website

**PRICE PROMISE GUARANTEE**



**Acid Free Tissue Wrapping Paper**

**See Page 1187**



**SILICON WHEELS (FOR REDUCING, SMOOTHING & POLISHING)**

**Silicon Rubber Wheels (Eve)**



Eve Silicon Wheel Finishers Leaders through innovation, quality, and precision. These silicone-bonded general-purpose polishers work quickly and efficiently on many materials.

Specifications:

- White - Reducing
- Black - Smoothing
- Blue - High Lustre Polishing
- Pink - Super High Lustre Polishing
- Grey - Platinum & Titanium Smoothing
- Lavender - Platinum & Titanium High Lustre Polishing
- Size: Ø100 x 15mm
- Lead Hole: Ø12.7mm
- Take a wheel mandrel

Eve silicon wheels can be used in a wide variety of manufacturing applications and are used in many industries. They are very flexible and adapt to contours very well. No additional compounds are required. These silicone polishers offer palpable advantages for reducing and smoothing.

Jewellery manufacture & other trades / industries: For coarse reducing and smoothing of gold, silver platinum, palladium, high-grade steel, titanium and other materials for the removal of the casting skin, and excellent mirror-finish lustre on fine items of jewellery.

Code	Description	UOM	Price
P1315L	White - Reducing (Coarse)	EACH	£23.95
P1316L	Black - Smoothing (Medium)	EACH	£23.95
P1317L	Blue - High Lustre Polishing	EACH	£23.95
P1318L	Pink - Super High Lustre Polishing	EACH	£23.95
P6508H	Grey - Smoothing (Platinum)	EACH	£23.95
P6511H	Lavender - High Lustre Polishing (Platinum)	EACH	£23.95

Price breaks available, see website

**SILICON WHEELS WITH PUMICE (FOR JEWELLERY WITH STONES)**

**Silicon Wheels with Pumice**



Eve Silicon wheels infused with pumice.

For use on any jewellery already containing set precious, non precious & synthetic stones. The special composition of these polishers ensure no damage to the stone, as well as providing a light buffer.

- Medium – Pre-polishing & smoothing
- Fine – Final finish polishing
- Size: Ø100 x 15mm
- Lead Hole: Ø12.7mm

Great for:

- Jewellery containing stones
- Precious metals (including alloys), including gold and silver
- Non precious metals (including alloys)
- Precious and synthetic stones

Pumice is a natural product therefore the colours/shades can vary

Code	Description	UOM	Price
P42376	Green - Medium	EACH	£22.50
P42377	Green - Medium	EACH	£22.50

Price breaks available, see website

**STEEL WHEELS**

**Steel Wheels**



Steel Wheels:

- Are very popular for jewellers, silversmiths, clock makers/repairers, light engineers, model makers and for arts and crafts
- Steel brushes are recommended for hard metals such as aluminium, carbon steel, gilding metals and stainless steel
- Are very economical and an efficient method for batch work
- Can clean chains safely and get into awkward areas easily
- Are perfect for antique silverware and medal renovation

Cousins' Steel Wheels' wires are made from 100% best grade steel. They are used to clean up or for texturing various types of metals (please see second bullet point).

The fine grade of wire gives a smooth and shiny finish; these lines have proven to be very popular, due to their low cost and efficiency.

The bristles of the wheel can penetrate deep recesses, but still give an equal finish to a flat surface, without disrupting the shape of the piece; producing a brilliant shiny finish with very little effort.

Steel wheel brushes will not damage the piece(s).

Cousins' supplies polishing equipment, we recommend the following best sellers to use with our extensive range of polishing accessories

- Polishing Motor Twin With Extractor Fan (Ventura 2) - P8760
- Polishing Motor Variable Speed, Foredom - BL2CE
- Polishing Motor Twin On Base With Extractor Fan (Polimax 1) - P8670

Code	Description	UOM	Price
P40233	Ø48mm Steel Crimp Wire	EACH	£1.25
S32208	Ø51mm Steel Crimp Wire, Hatho	EACH	£2.95
S32207	Ø51mm Stainless Steel, Straight Wire, Hatho	EACH	£12.25
P1287	Ø51mm Stainless Steel, Straight Wire, Bergeon	EACH	£29.95

Price breaks available, see website

**Ø40mm Texturing Wheels, Hatho**



New and improved Hatho Mini Mat Wire Wheels Made in Germany.

The Finest Results

Jewellery keeps in step with current tastes. The design of rings, brooches, necklaces, bangles, watches and tie tacks evolves with the fashion of clothing, cars and interior design. But in every change, one thing remains constant: adding highly textured surfaces are, and always will be, number one when it comes to jewellery finishing. Hatho's high quality Mini Mat Wire Wheels are perfectly suited to the attainment of such surfaces.

These wheels are available now with replacement wires, heads and spindles (sold separately), an excellent idea to save money as well as prolonging the life of the tool.

Add some texture with texturing wheels. Create a beautiful textured finish-quickly and easily.

These wheels can easily be mounted onto pendant drills, micro motors and polishing machines.

The Hatho Mini Mat wheels give the effect similar to the bark of a tree; however when applying different grades the wheel gives a completely unique look, this is due to the thickness of the wire, the thicker the wire the deeper the texture.

- Excellent wear and tear properties as the wires are made from best grade steel.
- Each wire end tip has a slight 45 degree backward angle integrated on the spoke, to reduce wire breakage and to give a uniform textured finish.
- Use dry, no compounds needed.
- Can be used on a wide range of metals including brass, copper, gold, silver, platinum, palladium, titanium, pewter, tin, steel, iron and aluminium.
- A very economical and efficient method of batch work.
- More wires per head giving a more even finish.
- Most popular way of using Hatho Mini Mat wheels is to use in the Cousins Precious Metals Collecting Box (B32963) which protects injury if a wire detaches during use, while also collecting lemel created from this process. A full range of safety equipment is available, please see links below.
- Leaves a contrasting finish on jewellery.

Dimensions:

- Ø40mm
- Wire Ø0.30, 0.45 & 0.60mm
- Overall length 60mm
- Top head plastic hub width 12mm
- Mounted on Ø2.35mm (3/32" Inch) shank

Specification:

- Fine - 8 sections, 16 wires on each row (P33539)
- Medium - 8 sections, 12 wires on each row (P33540)
- Coarse - 8 sections, 8 wires on each row (P33541)

Cousins' supplies a range of rotary equipment, we recommend the following best sellers to use with our extensive range of rotary attachments.

- Foredom Micro motor - K1070CE
- Jewellers Kit & No30 Hand piece - K2230CE



- Einhell Germany Rotary kit including flexi shaft with 217 accessories - G33522

Code	Description	UOM	Price
P33539	Complete Wheel, Ø0.30mm (Fine) Hatho	EACH	£20.95
P33540	Complete Wheel, Ø0.45mm (Medium) Hatho	EACH	£20.95
P33541	Complete Wheel, Ø0.60mm (Coarse) Hatho	EACH	£20.95
P33545	Centre Boss Hub, Hatho	EACH	£12.85
P33546	Mandrel, Hatho	EACH	£3.95
P33542	Wires Ø0.30mm, Hatho	PACK*64	£9.95
P33543	Wires Ø0.45mm, Hatho	PACK*48	£9.95
P33544	Wires Ø0.60mm, Hatho	PACK*32	£9.95

## Ø80mm Texturing Wheels, A\*F Swiss



Add some texture with texturing wheels. Create a beautiful textured finish-quickly and easily.

These wheels can easily be mounted onto polishing motors

The wheels give the effect similar to the bark of a tree; however when applying different grades the wheel gives a completely unique look, this is due to the thickness of the wire, the thicker the wire the deeper the texture.

- Use dry, no compounds needed.
- Used on a wide range of metals including brass, copper, gold, silver, platinum, palladium, titanium, pewter, tin, steel, iron and aluminium
- These texturing wheels have excellent wear and tear
- Very economical and an efficient method for batch work
- Gives a textured finish on rings, bracelets, pendants, bangles, brooches, cufflinks and tie pins
- Leaves a contrasting finish on jewellery
- A\*F Swiss

Sizes:

- Diameter of wheel Ø80mm
- Length of each steel wire 30mm
- Centre plastic hub width diameter Ø50mm
- Width of plastic centre holding steel wires Ø22mm

Cousins' supplies polishing equipment, we recommend the following best sellers to use with our extensive range of polishing accessories

- Polishing Motor Twin With Extractor Fan (Ventura 2) - P8760
- Polishing Motor Variable Speed, Foredom - BL2CE
- Polishing Motor Twin On Base With Extractor Fan (Polimax 1) - P8670

Code	Description	UOM	Price
P5087	Ø0.20mm (Fine) Wheel	EACH	£30.95
P5088	Ø0.45mm (Medium) Wheel	EACH	£30.95
P5089	Ø0.63mm (Coarse) Wheel	EACH	£30.95

Price breaks available, see website

### Cotton Polishing Gloves

See Page 817



## Ø85mm Texturing Wheels, Non EU



Easily add some texture and pattern with steel texturing wheels. Create a beautiful textured finish-quickly and easily.

The wheels give the effect similar to the bark of a tree; however when applying different grades the wheel gives a completely unique look, this is due to the thickness of the wire, the thicker the wire the deeper the texture.

- Extra coarse, coarse, medium & fine
- Use dry, no compounds needed
- Used on a wide range of metals including brass, copper, gold, silver, platinum, palladium, titanium, pewter, tin, steel, iron and aluminium
- Plastic hub, can easily screw onto mandrel
- These texturing wheels have excellent wear and tear
- Very economical and an efficient method for batch work
- Gives a textured finish on rings, bracelets, pendants, bangles & brooches
- Leaves a contrasting finish on jewellery
- Max 6000RPM

Sizes (approx.):

- Overall diameter of wheel Ø85mm
- Length of each steel wire 30mm
- Centre plastic hub bore diameter Ø8 to 15mm

Dimension Stated: Wire Diameter

Code	Description	UOM	Price
P40213	Ø0.20mm Steel (Fine)	EACH	£6.50
P40214	Ø0.30mm Steel (Medium)	EACH	£6.50
P40215	Ø0.45mm Steel (Coarse)	EACH	£6.50
P40216	Ø0.60mm Steel (Extra Coarse)	EACH	£6.50

Price breaks available, see website

## TRESS

### Tress (Polishing)



Hatho Cotton Thread Tress - Made in Germany - Fine Polishing Thread - Ultra Mirror Finish

We all agree a highly polished item is essential to

catch the eye of a potential customer leading to a purchase. Polishing cotton thread tress is the perfect way of adding an expert final touch to rings, bracelets, earrings, pendants, watches, etc.

Get into any area where a polishing mop or abrasive wheel can not reach.

How to use:

- Tap a household nail into the side of your bench, or a bench vice (please see link below)
- Undo the polishing tress and ties or clamp a few strands onto the nail or vice.
- Hold the thread from the other end and pull until tight.
- By holding the polishing thread tight run a polishing composition bar over the thread impregnating it with the composition.
- Run the piece up and down to the unpolished area and achieve the expert final finish.

Applications:

- Polish between filigree jewellery, particularly Asian styles.
- Excellent for polishing peg cluster claws, settings, the background of settings, thus gemstones especially diamonds look sparkling.
- Use when refurbishing gold, silver, stainless steel, titanium metal watch bracelets gives added credibility to a finished piece when in-between links, etc are highly polished.

We supply a large range of polishing compounds to polish all kinds of metals, please see links below.

Code	Description	UOM	Price
C33538	Cotton Thread Tress	EACH	£6.80

## WHEELS, MOPS, CONES & MANDRELS - MINI

### ALUMINIUM OXIDE WHEELS (FOR A MATT OR SATIN FINISH) MOUNTED



Composition of a spun polypropylene fibre containing aluminium oxide greatly enhances its abrasive power to the extent that it will actually scratch glass.

Hand finishing using abrasive paper such as wet and dry or emery paper can at times be time consuming and laborious. Instead, use an abrasive, a scotchbrite or unitized mounted wheel to achieve that first stage polish quickly and effectively.

Aluminium oxide:

- Aluminium oxide for matt or satin finishing on most metals
- Create a unique finish on your jewellery or watch cases
- Also for deburring and de-oxidisation
- Use dry, no compounds needed
- Used on a wide range of metals including brass, copper, gold, silver, platinum,

palladium, titanium, pewter, tin, steel, iron and aluminium

- Commonly used for light cleaning and rust removing work
- Fast effective way to remove old lacquers from aged clocks

Ageing/antique finishing:

Midget abrasive buffs/brushes can be used to create a antique finish using a ageing ammonium hydro sulphide chemical (our code C6263) or a metal ageing chemical CC60 (our code C6264).

When you have blackened your item use midget abrasive buff/brush to take off the silver ageing ammonium hydro sulphide chemical. Where the midget abrasive buff/brush can't reach in those hard to reach areas it will give you the effect of an aged piece.

Ever wondered how they do the finish on Gothic Celtic jewellery and models?

- Aluminium oxide wheels are used to create an antique finish using ageing ammonium hydro sulphide chemical, our code C6263, or metal ageing chemical CC60, our code C6264
- When you have blackened the item, use an aluminium oxide wheel to take off the silver ageing ammonium hydro sulphide chemical
- The areas the wheel can not reach will leave an aged effect on the piece
- In a time were antique & Gothic jewellery is becoming more popular, this is a quick and easy way to obtain this look in a professional yet economical fashion

### Mounted Fibril

VALUE



The midget abrasive buff/brush are ideal for satin finishing

Specifications:

- Head Ø22mm
- Thickness 12mm
- Ø3/32" or 2.35mm shank mount
- Colours may vary
- Max 3000 RPM

Aluminium oxide:

- Non woven mini mop, compressed material, best quality fibril
- Aluminium oxide for matt or satin finishing on most metals
- Create a unique finish on your jewellery or watch cases
- Also for deburring and de-oxidisation
- Use dry, no compounds needed
- Used on a wide range of metals including brass, copper, gold, silver, platinum, palladium, titanium, pewter, tin, steel, iron and aluminium
- Commonly used for light cleaning and rust removing work
- Fast effective way to remove old lacquers from aged clocks
- Very good to do large batch loads of work with economical spending

- The lower the grit number, the coarser the material

Code	Description	UOM	Price
P40212	240 Grit Abrasive Wheel	EACH	£0.25
P40217	400 Grit (Medium) Abrasive Wheel	EACH	£0.35
Price breaks available, see website			

### Mounted Fibril, Scotch-Brite



Manufactured by 3M - The midget abrasive buff/brush are ideal for satin finishing.

Specifications:

- Ø19, 22 or 25mm
- Materials by 3M
- Ø3/32" or 2.35mm shank mount
- 150, 400 or 800 grit
- Colours may vary
- Max 3000 RPM

Aluminium oxide:

- Non woven mini mop, compressed material, best quality fibril
- Aluminium oxide for matt or satin finishing on most metals
- Create a unique finish on your jewellery or watch cases
- Also for deburring and de-oxidisation
- Use dry, no compounds needed
- Used on a wide range of metals including brass, copper, gold, silver, platinum, palladium, titanium, pewter, tin, steel, iron and aluminium
- Commonly used for light cleaning and rust removing work
- Fast effective way to remove old lacquers from aged clocks
- Very good to do large batch loads of work with economical spending
- The lower the grit number, the coarser the material

Code	Description	UOM	Price
P40220	150 Grit, Ø19mm	EACH	£0.75
P40221	150 Grit, Ø22mm	EACH	£0.75
P40222	150 Grit, Ø25mm	EACH	£0.75
P40223	400 Grit, Ø19mm	EACH	£0.75
P40224	400 Grit, Ø22mm	EACH	£0.75
P40225	400 Grit, Ø25mm	EACH	£0.75
P40226	800 Grit, Ø19mm	EACH	£0.75
P40227	800 Grit, Ø22mm	EACH	£0.75
P40228	800 Grit, Ø25mm	EACH	£0.75
Price breaks available, see website			

### Polisher Bracelet Holder

See Page 772



### Pen Plating Solution Gold 18ct

See Page 1190



### Mounted Fibril, SIA

SIA



Manufactured by SIA - The midget abrasive buff/brush are ideal for satin finishing.

Specifications:

- Head Ø25mm
- Thickness 15mm
- Ø3/32" or 2.35mm shank mount

Aluminium oxide:

- Non woven mini mop, compressed material, best quality fibril
- Aluminium oxide for matt or satin finishing on most metals
- Create a unique finish on your jewellery or watch cases
- Also for deburring and de-oxidisation
- Use dry, no compounds needed
- Used on a wide range of metals including brass, copper, gold, silver, platinum, palladium, titanium, pewter, tin, steel, iron and aluminium
- Commonly used for light cleaning and rust removing work
- Fast effective way to remove old lacquers from aged clocks
- Very good to do large batch loads of work with economical spending
- The lower the grit number, the coarser the material

Code	Description	UOM	Price
P4189	60 Grit Abrasive Brush	EACH	£0.99
P4188	180 Grit Abrasive Brush	EACH	£0.99
P4187	400 Grit Abrasive Brush	EACH	£1.50
Price breaks available, see website			

### Mounted Fibril with Wet & Dry Paper, Scotch-Brite

3M



Manufactured by 3M - Fibril with Wet & Dry Paper

- Combination aluminium oxide with wet and dry paper inter layered between
- Less aggressive than aluminium oxide wheels on their own
- Flap wheel, allows greater and easier cooling
- High removal rates with a cool grinding action
- Gives a uniform grain finish
- Scotchbrite material with Hermes wet and dry paper
- The lower the grit number, the coarser the material

Specifications:

- Ø15 or Ø26mm
- Materials by Scotchbrite & Hermes
- Ø3/32" or 2.35mm shank mount
- 180, 320, 400 or 600 grit
- Colours may vary

### Aluminium oxide:

- Non woven mini mop, compressed material, best quality fibril
- Aluminium oxide for matt or satin finishing on most metals
- Create a unique finish on your jewellery or watch cases
- Also for deburring and de-oxidisation
- Use dry, no compounds needed
- Used on a wide range of metals including brass, copper, gold, silver, platinum, palladium, titanium, pewter, tin, steel, iron and aluminium
- Commonly used for light cleaning and rust removing work
- Fast effective way to remove old lacquers from aged clocks
- Very good to do large batch loads of work with economical spending
- The lower the grit number, the coarser the material

Code	Description	UOM	Price
M44292	180 Grit, Ø15mm	EACH	£2.40
M44296	180 Grit, Ø26mm	EACH	£4.20
M44293	320 Grit, Ø15mm	EACH	£2.40
M44297	320 Grit, Ø26mm	EACH	£4.20
M44294	400 Grit, Ø15mm	EACH	£2.40
M44298	400 Grit, Ø26mm	EACH	£4.20
M44295	600 Grit, Ø15mm	EACH	£2.40
M44299	600 Grit, Ø26mm	EACH	£4.20

## Mounted Fibril, Unitized (Compressed)

COUSINSUK



Cousins UK - UK Made

Unitized Wheels are a majority favourite material used in the finishing industry.

- Compressed nylon abrasive that can be used on all metals
- Compressed nylon leaves uniform results whilst creating little fibrous mess
- If used on ferrous metals it can clean up light marks and stains in one hit also leaving a good finish
- For none ferrous metals it is good for file line removal, light and heavy burr marks
- Popular for texturing precious metals; gold, silver, platinum etc
- Long lasting allowing large batch work without constant replacement of the wheel
- Notice whilst in use, unitized wheels will give less abrasive residue, giving you a cleaner working environment

### Specification:

- Wheel size: Ø22mm
- Thickness: 3.80mm
- 3/32" or 2.35mm shank
- Made in UK

### Aluminium oxide:

- Aluminium oxide for matt or satin finishing on most metals
- Create a unique finish on your jewellery or watch cases
- Also for deburring and de-oxidisation
- Use dry, no compounds needed
- Used on a wide range of metals including brass, copper, gold, silver, platinum, palladium, titanium, pewter, tin, steel, iron and aluminium

- Commonly used for light cleaning and rust removing work
- Fast effective way to remove old lacquers from aged clocks

Useful ways Unitized wheels can do for your production work:

- P35552 - Reducing your metal removing deep file marks, casting flashes, starches etc.
- P35553 - Smoothing your metal ready for first stage polishing
- P35554 - Giving impressive matting finish adding contrast to your jewellery work

Code	Description	UOM	Price
P35554	240 Grit (Fine), Unitized Wheel	EACH	£2.25
P35553	120 Grit (Medium), Unitized Wheel	EACH	£2.25
P35552	80 Grit (Coarse), Unitized Wheel	EACH	£2.25

Price breaks available, see website

## CUP & PENCIL BRUSHES (BRISTLE, BRASS & STEEL) MOUNTED



A wide range of application are used with Mounted Pencil, Cup Brushes and are used in many industries.

Mounted Pencil and Cup Brushes have excellent resilience and last longer when in use.

Used with the appropriate compounds you can get a high standard, semi-bright mirror finish.

Mounted Pencil, Cup Brushes:

- are very popular for jewellers, silversmiths, light engineers, model makers and in arts and crafts.
- can be used on a whole range of metals such as gold, silver, platinum, titanium, palladium, copper, brass, aluminium and steel.
- are very useful getting into grooves, uneven surfaces, and cup/dish style shapes
- can be mounted onto rotary headpieces spindles in order to reach awkward areas (see below for recommended rotary machines)
- popular to polish jewellery stone setting mounts, inside silver/gold boxes, and inside holes
- are a very economical and efficient method for batch work.
- used as a forward rotary action makes you will find there will be not metal centre marking your items just pure bristles

### Size:

- mounted on 3/32" shank or 2.35mm
- overall length 50mm

### Recommend compounds

- P1388 Dialux Rouge
- P7809 Platinum Final Finish Polinum Polishing Compound
- P1394 Hyfin Final Finish Compound
- P1410 Tripoli General Purpose Polishing Compound

### Recommended rotary machines:

Foredom Grinder Micromotor Kit: FDK1020  
Jewellers Kit & No20 "Quick Release"  
Handpiece: K2220CE

Rotary Drill & Tool Kit, Variable Speed: D9821

## Bristle Cup Brushes, Mini

COUSINSUK



Cousins UK - UK Made

Traditional cup bristle brushes have been the ideal manufacturers' choice for many generations.

- Cup bristle brushes are recommended for many types of metals; gold, silver, platinum, copper, brass etc.
- Perfect to reach into any crevice or bowl shape
- Bristles are excellent to get into grooves, slits or uneven surfaces
- Precision made excellent quality
- Ø13mm x 10mm
- Made in Britain

### Uses:

- P31638 - Final finish, use with compound P34668
- P31639 - Semi finish, use with compound P3655
- P1294M - Semi finish, use with P1388
- P1293M - Semi finish, use with compound P1394

Code	Description	UOM	Price
P31638	Soft (White) Goat Hair Cup	EACH	£0.78
P31639	Medium (White) Nylon Cup	EACH	£0.78
P1294M	Medium (Black) Bristle Cup	EACH	£0.63
P1293M	Stiff (White) Bristle Cup	EACH	£0.78

Price breaks available, see website

## Bristle Pencil Brushes, Mini

COUSINSUK



Cousins UK - UK Made

Traditional pencil bristle brushes have been an ideal manufacturers' choice for many generations.

- Pencil bristle brushes are recommended for many types of metals; gold, silver, platinum, copper, brass etc.
- Perfect to reach into any deep crevice or hole
- Bristles are excellent to get into grooves, slits or uneven surfaces
- Precision made excellent quality
- Ø5mm x 12mm
- Made in Britain

### Uses:

- P1298M - Semi finish, use with P1388
- P1297M - Semi finish, use with compound P1394

Code	Description	UOM	Price
P1298M	Medium (Black) Bristle	EACH	£0.60
P1297M	Stiff (White) Bristle	EACH	£0.60

Price breaks available, see website

www.

Online Discounts

Wire Cup Brushes, Mini



Cousins UK - UK Made

Brass Cups (Ø13mm x 10mm):

- Brass brushes are recommended for soft metals such as gold, silver, brass and bronze
- Chains can be cleaned safely, easily for getting into awkward areas
- Perfect for antique silverware and medal renovation

Made from 100% brass. They are very popular and used to clean up or for texturing various types of metals. The fine grade of wire gives a smooth shiny finish. When using these fine brass wire brushes you should use soap or a detergent with water as a lubricant otherwise a dull layer of brass will be deposited on your metal particularly on silver. Brass Cup Brushes will not damage your pieces.

Code	Description	UOM	Price
P1296M	Cup (Ø13mm x 10mm), Coarse	EACH	£0.82
P1300M	Pencil (Ø5mm x 12mm), Coarse	EACH	£0.80
Price breaks available, see website			

Steel Wire Brushes, Mini



Cousins UK - UK Made

Steel Pencils (Ø5mm x 12mm):

- Very popular with jewellers, silversmiths, clock makers/repairers, light engineers, model makers and for arts and crafts
- Steel brushes are recommended for hard metals such as aluminium, carbon steel, gilding metals and stainless steel
- Can clean chains safely and get into awkward areas easily
- Are perfect for antique silverware and medal renovation

Made from 100% best grade steel. They are used to clean up or for texturing various types of metals. The fine grade of wire gives a smooth and shiny finish, these lines have proven to be very popular, due to their low cost and efficiency.

Code	Description	UOM	Price
P1295M	Cup (Ø13mm x 10mm), Coarse	EACH	£0.82
P1299M	Pencil (Ø5mm x 12mm), Coarse	EACH	£0.78
Price breaks available, see website			

Acid Free Tissue Wrapping Paper

See Page 1187



CUTTING DISCS

Glass Fibre Cutting Discs



Cousins UK - MAXCUT Cutting Discs

Glass fibre reinforced grinding wheels for cutting and slitting. The grinding wheels can be mounted on low powered motors or stationary grinders.

The production uses the most advanced technology and superior quality materials.

- Diamond impregnated & glass fibre reinforced
- Ultra thin
- High cutting efficiency
- No vibration
- Low dust development
- Unbreakable
- Use dry, no compounds needed
- Used on a wide range of metals including brass, copper, gold, silver, platinum, palladium, titanium, pewter, tin, steel, iron, porcelain, aluminium, ceramic and steel alloys
- The max cut cutting discs has very good wear and last longer when in use
- Very good to do large batch loads of work with economical spending
- Very popular for Jewellers, Silversmiths, Light Engineers, Model Makers and in Arts and Craft
- Made in UK

Ideal in Jewellery making or repairing for cutting Jump rings, wire and slitting for hinges etc.

Texturing grooves on items e.g. rings bracelets & earrings.

Very good for cutting thicker items than sawing or saw piecing

Watch Bracelet end cutting or applications within clock part making / adapting Watch Bracelet end cutting or applications within clock part making / adapting.

- use mandrel product Code P1343M for Max Cutting Discs C30565, C30566, and C30567
- use mandrel product Code M20875 for Max Cutting Discs C30568
- Ø20mm = 20,000 - 25,000 r.p.m.
- Ø26mm = 15,000 - 20,000 r.p.m.
- Ø40mm = 15,000 - 20,000 r.p.m.
- Diamond Impregnated for Longer Lasting

Code	Description	UOM	Price
C30565	Ø20mm (Thick Ø0.20mm) Diamond Impregnated	EACH	£2.80
C30566	Ø20mm (Thick Ø0.30mm) Diamond Impregnated	EACH	£2.70
C30567	Ø26mm (Thick Ø0.30mm)	EACH	£1.15
C30568	Ø40mm (Thick Ø0.50mm)	EACH	£1.50
Price breaks available, see website			

PRICE PROMISE GUARANTEE

Steel Cutting Discs



Cousins UK - Save time and money by cutting straight and precisely with our Circular Mini Mounted Saws.

Just some of their many uses:

- After making jump rings on a mandrel use these tools to cut free you links.
- Cut a slit for screw heads
- Use with a joint cutting tool to cut tube/wire fast, accurately and with ease. Put a circular saw into the cutting slit instead of a saw blade (code C32967/ C32968)
- Texture designs on to items to add distinction.
- When testing precious metal use these saws to cut away suspected plate, much quicker than the traditional saw piercing method.
- Circular Mini mounted Saws come mounted with screw on mandrels (M32971) with shank size are 2.35mm (3/32).
- Thickness of mini saws Blades 0.1mm
- Length 45mm
- Weight: 9grms

Code	Description	UOM	Price
C32964	Ø13mm Mounted Steel Saw	EACH	£3.95
C32965	Ø16mm Mounted Steel Saw	EACH	£3.95
C32966	Ø19mm Mounted Steel Saw	EACH	£3.95
C32967	Ø22mm Mounted Steel Saw	EACH	£3.95
C32968	Ø25mm Mounted Steel Saw	EACH	£4.95
Price breaks available, see website			

DIAMOND IMPREGNATED WHEELS

Diamond Impregnated Wheels



Cousins UK - Diamond impregnated wheels, impressive tooling at a value price.

Electroplated diamond particles are the ultimate material for all metal cutting, removing, and texturing.

- Ø25mm
- 0.60mm thick edge
- Pack\*12
- Comes with two mandrels (Ø3.10mm)
- Supplied in plastic wallet
- Great value

Diamond texturing/cutting/sanding:

- Add a fine fantastic texturing effect on jewellery. When texturing with these wheels the unique diamond particles will transfer the effect onto the piece leaving the same glittering finish on the metals as it looks on the wheel itself. I.e. The finish looks like glitter has been sprinkled onto the piece



- Ideal to create the perfect channel mounts with fast cutting properties ready for stone setting
- Most popular texturing effects in Asian Jewellery before the diamond milling process known as the Shubernum effect
- Grinds/smoothes away excess metal such as solder
- Used in the glass, engraving and sculpture industry puts a misty / frosty effect on glass and grind/shape ceramics with ease
- Very popular with jewellers, silversmiths, watch makers/repairers, light engineers, model makers plastic fabricators and in arts and crafts
- Can be used on a whole range of materials such as gold, silver, platinum, copper, brass, pewter, bronze, glass aluminium, and ceramics
- Precious metal testing grind/remove surface if plated before testing with Acid testing Bottles
- Finest quality for reliability, long life and satisfaction guaranteed
- For glass engraving / texturing & reaming stones and beads, always use water as a lubricant with diamond tools / instruments
- No lubrication required for texturing on metal

Code	Description	UOM	Price
D38763	Diamond Impregnated Wheels	PACK*12	£9.95

## Diamond Impregnated Wheels, Mounted



Cousins UK - Diamond impregnated wheels mounted  
Electroplated diamond particles are the ultimate material for all metal cutting, removing, and texturing.

- Add a fine fantastic texturing effect on jewellery. When texturing with these wheels the unique diamond particles will transfer the effect onto the piece leaving the same glittering finish on the metals as it looks on the wheel itself. I.e. The finish looks like glitter has been sprinkled onto the piece.
- Ideal to create the perfect channel mounts with fast cutting properties ready for stone setting
- Most popular texturing effects in Asian Jewellery before the diamond milling process known as the Shubernum effect.
- Grinds/smoothes away excess metal such as solder
- Used in the glass, engraving and sculpture industry puts a misty / frosty effect on glass and grind/shape ceramics with ease.
- 140/170 grits
- Shank body size Ø2.35mm or 3/32", which can be used in micro motors and standard quick release hand pieces, (making it easy to change burrs quickly and easily) as well as conventional chuck hand pieces
- Very popular with jewellers, silversmiths, watch makers/repairers, light engineers, model makers plastic fabricators and in arts and crafts
- Can be used on a whole range of materials such as gold, silver, platinum, copper, brass, pewter, bronze, glass aluminium, and ceramics
- Precious metal testing grind/remove surface if plated before testing with Acid testing Bottles
- Finest quality for reliability, long life and satisfaction guaranteed
- For glass engraving / texturing & reaming stones and beads, always use water as a lubricant with diamond tools / instruments.
- No lubrication required for texturing on metal.

Sizes:  
D33892 – Ø13mm x 0.7mm  
D33893 – Ø19mm x 1.25mm

Weights: 15 grams

Code	Description	UOM	Price
D33892	Ø13mm Diamond Wheel, Mounted	EACH	£2.95
D33893	Ø19mm Diamond Wheel, Mounted	EACH	£2.95

## DRUM SANDERS & ROLL SANDERS

### Drum Sanders



Cousins UK - Drum Sander Arbors and Abrasive Bands  
Mini roll sanders have a wide range of applications and are used in a wide variety of industries. Used with the appropriate grade you can get a high standard, semi-bright mirror finish.

Glue bonded, silicon carbide for fast cutting. Provides chatter free operation for grinding, blending, deburring, smoothing, finishing and polishing flat and contoured surfaces.

- Using the quick expand spindles, you will find it will save time when changing the drum sander bands
- Very popular for jewellers, silversmiths, light engineers, model makers and in arts and crafts
- Drum sanders are very useful to use for levelling off metals
- Used on a wide range of metals including brass, copper, gold, silver, platinum, bronze, palladium, titanium, pewter, tin, steel, iron and aluminium
- Using various grades you can level metals off as well as smoothing scratches, pit holes, file and casting flash marks
- You will find because of the rubber centre the abrasive surface will hold its shape well meaning you can apply pressure to the item
- Fast and easy to use in production, no need to use a split mandrel
- An economical way to do large batch work
- Very useful for getting into spherical awkward circular areas for example, inside rings and bangles
- Used dry no compounds needed

Specifications:

- Rubber heads
- Ø2.35mm Shafts.
- 2 diameters available, Ø9.50mm & Ø12mm
- All bands are 12.7mm (½") long
- Choice of 3 grit textures (coarse = 120, medium = 240, fine = 320)

Recommended rotary machines:

- Foredom Grinder Micromotor Kit: FDK1020
- Jewellers Kit & No20 "Quick Release" Handpiece: K2220CE
- Rotary Drill & Tool Kit, Variable Speed: D9821

Code	Description	UOM	Price
D32163	Ø9.5mm Mandrel Arbor	EACH	£2.50
FDASD326	Ø9.5mm Mandrel Arbor, Foredom	EACH	£4.95
D32163A	Ø9.5mm (120 grit) Bands	PACK*10	£0.80
D32163B	Ø9.5mm (240 grit) Bands	PACK*10	£0.80
D32163C	Ø9.5mm (320 grit) Bands	PACK*10	£0.80
D32164	Ø12mm Mandrel Arbor	EACH	£2.95
FDASD328	Ø12mm Mandrel Arbor, Foredom	EACH	£5.50
D32164A	Ø12mm (Grit 120) Bands	PACK*10	£1.20
D32164B	Ø12mm (Grit 240) Bands	PACK*10	£1.20
D32164C	Ø12mm (Grit 320) Bands	PACK*10	£1.20

Price breaks available, see website



Online Discounts

### Roll Sanders



Cousins UK - Mini roll sanders have a wide range of applications and are used in a wide variety of industries. Used with the appropriate grade you can get a high standard, semi-bright mirror finish.

- Are very popular for jewellers, silversmiths, light engineers, model makers and in arts and crafts
- Mini roll sanders are very useful to use for levelling off metals
- A wide variety of grades available
- Used on a wide range of metals including brass, copper, gold, silver, platinum, bronze, palladium, titanium, pewter, tin, steel, iron and aluminium.
- Using various grades you can level metals off, smoothing scratches, pit holes, file and casting flash marks
- You will find as you are using the paper, the used parts peel off to give you a new layer of abrasive
- Fast and easy to use in production, already mounted
- An economical way to do large batch work
- Are very useful for getting into spherical awkward circular areas for example, inside rings and bangles
- Used dry, no compounds needed
- Replacement mandrel, code M9476

Dimensions:

- Mounted on 3/32" shank or 2.35mm
- Overall length 50mm
- Mini roll sanders head size Ø13mm x 30mm

Recommended rotary machines:

- Foredom Grinder Micromotor Kit: FDK1020
- Jewellers Kit & No20 "Quick Release" Handpiece: K2220CE
- Rotary Drill & Tool Kit, Variable Speed: D9821

Code	Description	UOM	Price
P9576A	Grit 240 (Coarse) Mounted	EACH	£0.85
P9576B	Grit 320 (Semi Coarse) Mounted	EACH	£0.85
P9576C	Grit 400 (Medium) Mounted	EACH	£0.85
P9576D	Grit 600 (Semi Medium) Mounted	EACH	£0.85
P9576E	Grit 800 (Fine) Mounted	EACH	£0.85
P9576F	Grit 1000 (Extra Fine) Mounted	EACH	£0.85

Price breaks available, see website

## EVE POLISERS - ALUMINIUM OXIDE IMPREGNATED

### Aluminium Oxide Impregnated



Mini Polishers - Aluminium Oxide Impregnated - EVE

- Mini mops that are impregnated with aluminium oxide
- Soft, flexible material
- Give a high lustre finish on acrylics, ceramic and metals
- Longer lasting
- Wheel shape
- Ø22 x 3.5mm (diameter x thickness)
- Manufactured by EVE

Grades:

- Extra fine: Green
- Fine: Pink
- Medium: Orange

Features:

- Recommended RPM: 5000 to 7000 (Max 10,000 RPM)

Code	Description	UOM	Price
P47164	Extra Fine Aluminium Oxide Wheel	EACH	£2.25
P47163	Fine Aluminium Oxide Wheel	EACH	£2.25
P47162	Medium Aluminium Oxide Wheel	EACH	£2.25
Price breaks available, see website			

## EVE POLISHERS - DIAMOND IMPREGNATED

### Diamond Impregnated, Mounted



Mini Polishers - Diamond Impregnated - EVE Diapol

Using diamond impregnated polishers is the most efficient way to achieve better results in less time. Especially when working with hard materials such as platinum and titanium

Due to the special diamond mineral bond, these polishers are very long lasting and keep their shape particularly well whilst in use. Available in a 3 grades, as a set or individually.

Grades:

- Reducing: Green
- Smoothing: Grey
- High Lustre: Pink

Shapes:

- Pear: Ø4mm x 13mm Long
- Wheel: Ø11mm x 2mm Thick
- Wheel: Ø11mm x 4mm Thick

Features:

- Recommended RPM: 7000 to 10,000 (Max 20,000 RPM)
- Ø2.35mm shank

Code	Description	UOM	Price
P6500	Diamond Impregnated Mounted Silicon Polishers Set	PACK*9	£59.95
P6500A	Reducing Pear Ø4 x 13mm	EACH	£7.50
P6500B	Reducing Wheel Ø11 x 2mm	EACH	£7.50
P6500C	Reducing Wheel Ø11 x 4mm	EACH	£11.65
P6500D	Smoothing Pear Ø4 x 13mm	EACH	£7.50
P6500E	Smoothing Wheel Ø11 x 2mm	EACH	£7.50
P6500F	Smoothing Wheel Ø11 x 4mm	EACH	£10.75
P6500G	High Lustre Pear Ø4 x 13mm	EACH	£6.95
P6500H	High Lustre Wheel Ø11 x 2mm	EACH	£7.35
P6500I	High Lustre Wheel Ø11 x 4mm	EACH	£10.35
Price breaks available, see website			

## EVE POLISHERS - RUBBER (SYNTHETIC)

Synthetic rubber polishers are harder and therefore better for removing greater amounts of material. They are more durable and last longer than their softer silicone counterparts.

- Airflex - Have a special porous structure, providing a higher airflow during use which reduces the friction heat. These are especially good for polishing silver as the friction heat can cause the silver to blacken during polishing

- PT - Specifically designed for use on hard metals such as platinum, titanium and stainless steel

- Technik - For use on a variety of non precious metal alloys. They are long lasting and durable

Stages:

- Heavy Duty Removing
- Removing & Shaping
- Stage 1: Coarse Reducing
- Stage 2: Pre-Polish & Smoothing
- Stage 3: Final Finish (including matt & satin finish)
- Stage 4: Super High Lustre Finish

EVE silicone finishers are leaders through innovation, quality, and precision.

These silicone-bonded general-purpose polishers, work quickly and efficiently on many materials, ensuring sparkling results all round! These silicone polishers offer palpable advantages for reducing and smoothing.

Pforzheim, a town of nearly 119,000 inhabitants in southwest Germany, at the gate to the Black Forest, is world-famous for its jewellery and watch-making industry. A German equivalent to London's Hatton Garden or Birmingham's Jewellery Quarter. As early as 50 years ago, when the very first polishers started being produced, Pforzheim goldsmiths were being supplied with silicone polishers. Now, all types of specialised polishers are being made to meet the ever increasing standard and demand of jewellery manufacturers.

Today EVE is used in a wide ranging spectrum of industries including jewellers, watchmakers, dentistry, lab work and engineers. We have a wide range of EVE finishers to suit your high demand production needs. See our full listings below and don't forget our special bulk purchase price reductions!

### Airflex Stage 1 (Blue)



Coarse - Reducing - EVE Airflex - Synthetic Rubber Mini Polishers - Stage 1

Metal reducing polishers with an open porous structure reducing the friction heat

Great for:

- Precious metals (including alloys), including gold and silver
- Non precious metals (including alloys)

- Titanium
- Stainless steel
- Nickel

Features:

- Grit: Coarse
- Colour: Blue
- Composition: Synthetic rubber
- Recommended RPM: 7000 to 10,000 (Max 20,000 RPM)
- Open pore structure, allowing greater airflow during operation, reducing the friction heat

Mandrels:

- Screw on mandrels see code P1343M
- Threaded mandrels see code M4817

Code	Description	UOM	Price
P42023	Ø17 x 4mm	EACH	£0.75
P42022	Ø22 x 3mm	EACH	£0.75
Price breaks available, see website			

### Airflex Stage 2 (Green)



Pre-Polish - Smoothing - EVE Airflex - Synthetic Rubber Mini Polishers - Stage 2

Polishers with an open porous structure

Great for:

- Precious metals (including alloys), including gold and silver
- Non precious metals (including alloys)
- Titanium
- Stainless steel
- Nickel

Features:

- Grit: Medium
- Colour: Green
- Composition: Synthetic rubber
- Recommended RPM: 7000 to 10,000 (Max 20,000 RPM)
- Open pore structure, allowing greater airflow during operation, reducing the friction heat

Mandrels:

- Screw on mandrels see code P1343M
- Threaded mandrels see code M4817

Code	Description	UOM	Price
P42025	Ø17 x 4mm	EACH	£0.75
P42024	Ø22 x 3mm	EACH	£0.75
Price breaks available, see website			

### Airflex Stage 3 (Red)



Final Finish - EVE Airflex - Synthetic Rubber Mini Polishers - Stage 3

Final finish polishers with an open porous structure, reducing the friction heat

Great for:

- Precious metals (including alloys), including gold and silver
- Non precious metals (including alloys)

- Titanium
- Stainless steel
- Nickel

**Features:**

- Grit: Fine
- Colour: Red
- Composition: Synthetic rubber
- Recommended RPM: 7000 to 10,000 (Max 20,000 RPM)
- Open pore structure, allowing greater airflow during operation, reducing the friction heat

**Mandrels:**

- Screw on mandrels see code P1343M
- Threaded mandrels see code M4817

Code	Description	UOM	Price
P42027	Ø17 x 4mm	EACH	£0.75
P42026	Ø22 x 3mm	EACH	£0.75

Price breaks available, see website

## PT Stage 2 (Grey)



Pre-Polish - Smoothing - EVE PT- Synthetic Rubber Mini Polishers - Stage 2

Smoothing polishers specifically designed for use on hard metals such as platinum, titanium and stainless steel

**Great for:**

- Non precious metals (including alloys)
- Titanium
- Platinum
- Stainless steel

**Features:**

- Grit: Medium
- Colour: Grey
- Composition: Synthetic rubber
- Recommended RPM: 7000 to 10,000 (Max 20,000 RPM)
- Ø2.35mm shank

**Mandrels:**

- Screw on mandrels see code P1343M
- Threaded mandrels see code M4817

Code	Description	UOM	Price
P6508A	(1) Wheel Ø22 x 3mm	EACH	£0.42
P6508B	(3) Knife Ø22mm x 4mm	EACH	£0.42
P6508C	(4) Cylinder Ø7 x 20mm	EACH	£0.30
P6508D	(5) Bullet Ø5 x 16mm, Mounted	EACH	£0.95
P6508E	(6) Cylinder Ø14 x 12mm, Mounted	EACH	£1.75
P6508F	(7) Wheel Mounted Ø14.5mm x 2mm Smoothing Grey Mini Silicon	EACH	£1.25
P6508G	(8) Knife Ø14.5 x 2.5mm, Mounted	EACH	£1.20

Price breaks available, see website

## PT Stage 4 (Lavender)



Super High Lustre Finish - EVE PT - Synthetic Rubber Mini Polishers - Stage 4

High lustre polishers specifically designed for use on hard metals such as platinum, titanium and stainless steel

**Great for:**

- Non precious metals (including alloys)
- Titanium
- Platinum
- Stainless steel

**Features:**

- Grit: Extra fine
- Colour: Lavender
- Composition: Synthetic rubber
- Recommended RPM: 7000 to 10,000 (Max 20,000 RPM)
- Ø2.35mm shank

**Mandrels:**

- Screw on mandrels see code P1343M
- Threaded mandrels see code M4817

Code	Description	UOM	Price
P6511A	(1) Wheel Ø22 x 3mm	EACH	£0.42
P6511B	(3) Knife Ø22 x 4mm	EACH	£0.40
P6511C	(4) Cylinder Ø7 x 20mm	EACH	£0.42
P6511D	(5) Bullet Ø5 x 16mm, Mounted	EACH	£0.95
P6511E	(6) Cylinder Ø14 x 12mm, Mounted	EACH	£1.75
P6511F	(7) Wheel Ø14.5 x 2mm, Mounted	EACH	£1.25
P6511G	(8) Knife Ø14.5 x 2.5mm, Mounted	EACH	£1.20

Price breaks available, see website

## Technik Heavy Duty Removing (Dark Brown)

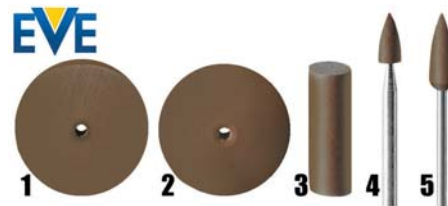

Metal Reducing - EVE Technik - Synthetic Rubber Mini Polishers - EVE 400 Series

Longer lasting, for casting skin removal polisher

**Great for:**

- Non precious metals (including alloys)
- Titanium
- Stainless steel
- Nickel

**Features:**

- Grit: Extra coarse
- Colour: Dark brown
- Composition: Synthetic rubber
- Recommended RPM: 7000 to 12,000 (Max 20,000 RPM)
- Ø2.35mm shank

**Mandrels:**

- Screw on mandrels see code P1343M

- Threaded mandrels see code M4817

Code	Description	UOM	Price
P42442	(1) Wheel Ø22 x 3mm	EACH	£0.38
P42445	(1) Wheel Ø26 x 1.2mm	EACH	£0.45
P42443	(2) Knife Ø22 x 4mm	EACH	£0.40
P42444	(3) Cylinder Ø7 x 20mm	EACH	£0.40
P42447	(4) Cone Ø3 x 7.5mm, mounted	EACH	£0.94
P42446	(5) Pear Ø5.5 x 18mm, mounted	EACH	£0.95

Price breaks available, see website

## Technik Removing & Shaping (Blue)



Metal Reducing - EVE Technik - Synthetic Rubber Mini Polishers - EVE 500 Series

Longer lasting, for metal reducing and shaping

**Great for:**

- Precious metals (including alloys), including gold and silver
- Non precious metals (including alloys)
- Stainless steel
- Nickel

**Features:**

- Grit: Very coarse
- Colour: Blue
- Composition: Synthetic rubber
- Recommended RPM: 7000 to 12,000 (Max 20,000 RPM)
- Ø2.35mm shank

**Mandrels:**

- Screw on mandrels see code P1343M
- Threaded mandrels see code M4817

Code	Description	UOM	Price
P42416	(1) Wheel Ø22 x 1mm	EACH	£0.36
P42417	(1) Wheel Ø22 x 3mm	EACH	£0.40
P42418	(2) Knife Ø22 x 4mm	EACH	£0.38
P42419	(3) Cylinder Ø6 x 22mm	EACH	£0.36
P42420	(3) Cylinder Ø7 x 20mm	EACH	£0.36
P42421	(4) Bullet Ø5 x 16mm, Mounted	EACH	£0.86
P42422	(5) Cylinder Ø14 x 12mm, Mounted	EACH	£1.50
P42423	(6) Wheel Ø14.5 x 2mm, Mounted	EACH	£0.90
P42424	(7) Knife Ø14.5 x 2.5mm, Mounted	EACH	£0.94
P42425	(8) Cone Ø3 x 7.5mm, Mounted	EACH	£0.94
P42426	(9) Cone Ø4.3 x 12mm, Mounted	EACH	£0.85
P42427	(10) Pear Ø5.5 x 18mm, Mounted	EACH	£0.95
P42428	(11) Wheel Ø19 x 0.5mm, Mounted	EACH	£0.95
P47152	(12) Radial Bristle Wheel Ø14mm	EACH	£1.75
P47153	(12) Radial Bristle Wheel Ø17mm	EACH	£1.75

Price breaks available, see website

## Freedom Micromotors

See Page: 684



PRICE PROMISE GUARANTEE

**Technik Stage 1 (Grey)**



Pre Polish - EVE Technik - Synthetic Rubber Mini Polishers - Stage 1 - EVE 600 Series

Longer lasting, metal pre-polishing & smoothing polisher

Great for:

- Precious metals (including alloys), including gold and silver
- Non precious metals (including alloys)
- Stainless steel
- Nickel

Features:

- Grit: Coarse
- Colour: Grey
- Composition: Synthetic rubber
- Recommended RPM: 7000 to 12,000 (Max 20,000 RPM)
- Ø2.35mm shank

Mandrels:

- Screw on mandrels see code P1343M
- Threaded mandrels see code M4817

Code	Description	UOM	Price
P42429	(1) Wheel Ø22 x 1mm	EACH	£0.36
P42430	(1) Wheel Ø22 x 3mm	EACH	£0.42
P42431	(2) Knife Ø22 x 4mm	EACH	£0.40
P42432	(3) Cylinder Ø6 x 22mm	EACH	£0.40
P42433	(3) Cylinder Ø7 x 20mm	EACH	£0.40
P42434	(4) Bullet Ø5 x 16mm, Mounted	EACH	£0.86
P42435	(5) Cylinder Ø14 x 12mm, Mounted	EACH	£1.40
P42436	(6) Wheel Ø14.5 x 2mm, Mounted	EACH	£0.90
P42441	(7) Wheel Ø19 x 0.5mm, Mounted	EACH	£0.95
P42438	(8) Cone Ø3 x 7.5mm, Mounted	EACH	£0.75
P42439	(9) Cone Ø4.3 x 12mm, Mounted	EACH	£0.94
P42440	(10) Pear Ø5.5 x 18mm, Mounted	EACH	£0.95
P42437	(11) Knife Ø14.5 x 2.5mm, Mounted	EACH	£0.97
P47154	(12) Radial Bristle Wheel Ø14mm	EACH	£1.75
P47155	(12) Radial Bristle Wheel Ø17mm	EACH	£1.75

Price breaks available, see website

**Technik Stage 2 (Brown)**

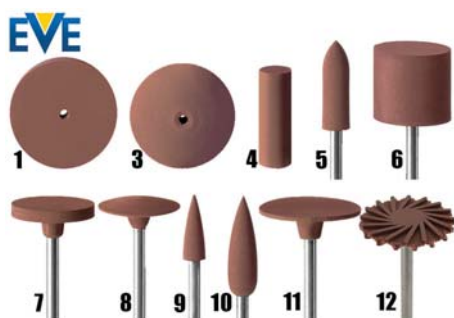

Pre Polishing & Matt or Satin Final Finish - EVE Technik - Synthetic Rubber Mini Polishers - Stage 2 - EVE 700 Series

Longer lasting, pre polishing or matt finish polishing

Great for:

- Non precious metals (including alloys)
- Titanium
- Stainless steel
- Nickel

Features:

- Grit: Medium
- Colour: Brown
- Composition: Synthetic rubber
- Recommended RPM: 7000 to 12,000 (Max 20,000 RPM)
- Ø2.35mm shank

Mandrels:

- Screw on mandrels see code P1343M
- Threaded mandrels see code M4817

Code	Description	UOM	Price
P5152B	(1) Wheel Ø22 x 1mm	EACH	£0.40
P5152A	(1) Wheel Ø22 x 3mm	EACH	£0.44
P5152C	(3) Knife Ø22 x 4mm	EACH	£0.40
P5152E	(4) Cylinder Ø6 x 22mm	EACH	£0.38
P5152D	(4) Cylinder Ø7 x 20mm	EACH	£0.36
P5152I	(5) Bullet Ø5 x 16mm, Mounted	EACH	£0.86
P5152F	(6) Cylinder Ø14 x 12mm, Mounted	EACH	£1.50
P5152K	(7) Wheel Ø14.5 x 2mm, Mounted	EACH	£0.98
P5152L	(8) Knife Ø14.5 x 2.5mm, Mounted	EACH	£1.00
P5152G	(9) Cone 3.3 x 7.5mm, Mounted	EACH	£0.94
P5152H	(9) Cone 4.3 x 12mm, Mounted	EACH	£0.94
P5152J	(10) Pear 5.5 x 18mm, Mounted	EACH	£0.90
P5152M	(11) Wheel Ø19 x 0.5mm, Mounted	EACH	£1.04
P47156	(12) Radial Bristle Wheel Ø14mm	EACH	£1.75
P47157	(12) Radial Bristle Wheel Ø17mm	EACH	£1.75

Price breaks available, see website

**Technik Stage 3 (Green)**



Final Finish - EVE Technik - Synthetic Rubber Mini Polishers - Stage 3 - EVE 800 Series

Longer lasting, high lustre polisher

Great for:

- Precious metals (including alloys), including gold and silver
- Non precious metals (including alloys)
- Stainless steel
- Nickel

Features:

- Grit: Fine
- Colour: Green
- Composition: Synthetic rubber
- Recommended RPM: 7000 to 12,000 (Max 20,000 RPM)
- Ø2.35mm shank

Mandrels:

- Screw on mandrels see code P1343M
- Threaded mandrels see code M4817

Code	Description	UOM	Price
P5153B	(1) Wheel Ø22 x 1mm	EACH	£0.38
P5153A	(1) Wheel Ø22 x 3.5mm	EACH	£0.43
P5153C	(3) Knife Ø22 x 1mm	EACH	£0.45
P5153E	(4) Cylinder Ø6 x 22mm	EACH	£0.40
P5153D	(4) Cylinder Ø7 x 20mm	EACH	£0.40
P5153I	(5) Bullet Ø5 x 16mm, Mounted	EACH	£0.95
P5153F	(6) Cylinder Ø14 x 12mm, Mounted	EACH	£1.75
P5153K	(7) Wheel Ø14.5 x 2mm, Mounted	EACH	£1.25
P5153L	(8) Knife Ø14.5 x 2.5mm, Mounted	EACH	£1.20
P5153G	(9) Cone 3.3 x 7.5mm, Mounted	EACH	£0.95
P5153H	(9) Cone 4.3 x 12.5mm, Mounted	EACH	£0.95
P5153J	(10) Pear Ø5.5 x 18mm, Mounted	EACH	£0.95
P5153M	(11) Wheel Ø19 x 0.5mm, Mounted	EACH	£1.10
P47158	(12) Radial Bristle Wheel Ø14mm	EACH	£1.75

P47159	(12) Radial Bristle Wheel Ø17mm	EACH	£1.75
--------	---------------------------------	------	-------

Price breaks available, see website

**Technik Stage 4 (Light Green)**



Super Final Finish - EVE Technik - Synthetic Rubber Mini Polishers - Stage 4 - EVE 900 Series

Longer lasting, super high lustre polisher

Great for:

- Precious metals (including alloys), including gold and silver
- Non precious metals (including alloys)
- Stainless steel
- Nickel

Features:

- Grit: Extra Fine
- Colour: Light green
- Composition: Synthetic rubber
- Recommended RPM: 7000 to 12,000 (Max 20,000 RPM)
- Ø2.35mm shank

Mandrels:

- Screw on mandrels see code P1343M
- Threaded mandrels see code M4817

Code	Description	UOM	Price
P42378	(1) Wheel Ø22 x 1mm	EACH	£0.36
P42379	(1) Wheel Ø22 x 3mm	EACH	£0.38
P42380	(3) Knife Ø22 x 4mm	EACH	£0.40
P42381	(4) Cylinder Ø6 x 22mm	EACH	£0.36
P42382	(4) Cylinder Ø7 x 20mm	EACH	£0.36
P42383	(5) Bullet Ø5 x 16mm, mounted	EACH	£0.86
P42384	(6) Cylinder Ø14 x 12mm, mounted	EACH	£1.60
P42385	(7) Wheel Ø14.5 x 2mm, mounted	EACH	£0.90
P42386	(8) Knife Ø14.5 x 2.5mm, mounted	EACH	£0.94
P42387	(9) Cone Ø3 x 7.5mm, mounted	EACH	£0.94
P42388	(9) Cone Ø4.3 x 12mm, mounted	EACH	£0.94
P42389	(10) Pear Ø5.5 x 18mm, mounted	EACH	£0.95
P42390	(11) Wheel Ø19 x 0.5mm, mounted	EACH	£0.95
P47160	(12) Radial Bristle Wheel Ø14mm	EACH	£1.75
P47161	(12) Radial Bristle Wheel Ø17mm	EACH	£1.75

Price breaks available, see website

**Foredom Pendant Motor**

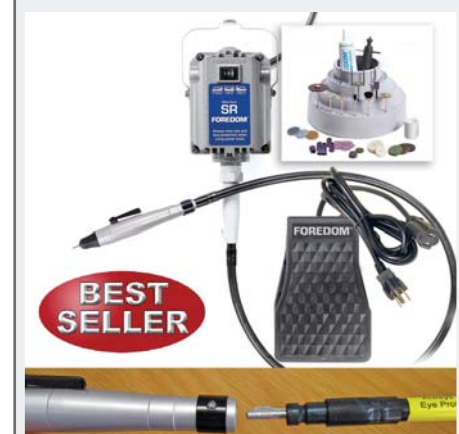

Ref: K2220CE See Page: 692

**Pin Polishers (EVEFLEX)**



Synthetic Rubber Mini Polishers - Pin Polishers (EVEFLEX)

Polishers ideal for areas with difficult access

Great for:

- Precious metals (including alloys), including gold and silver
- Non precious metals (including alloys)
- Stainless steel
- Nickel

Features:

- Grits: Coarse, medium, fine, extra fine, super extra fine
- Size: Ø3mm x 23mm
- Composition: Synthetic rubber
- Recommended RPM: 10000 to 15,000 (Max 30,000 RPM)

Mandrels:

- Screw on mandrels see code P19812

Code	Description	UOM	Price
P19813	Extra Hard Bond (medium grit)	EACH	£0.35
P19814	Hard Bond (coarse grit)	EACH	£0.35
P19815	Medium Bond (medium grit)	EACH	£0.35
P19816	Medium Bond (fine grit)	EACH	£0.35
P19817	Medium Bond (x - fine grit)	EACH	£0.35
P19818	Medium Bond (xx - fine grit)	EACH	£0.35
Price breaks available, see website			

many materials, ensuring sparkling results all round! These silicone polishers offer palpable advantages for reducing and smoothing.

Pforzheim, a town of nearly 119,000 inhabitants in southwest Germany, at the gate to the Black Forest, is world-famous for its jewellery and watch-making industry. A German equivalent to London's Hatton Garden or Birmingham's Jewellery Quarter. As early as 50 years ago, when the very first polishers started being produced, Pforzheim goldsmiths were being supplied with silicone polishers. Now, all types of specialised polishers are being made to meet the ever increasing standard and demand of jewellery manufacturers.

Today EVE is used in a wide ranging spectrum of industries including jewellers, watchmakers, dentistry, lab work and engineers. We have a wide range of EVE finishers to suit your high demand production needs. See our full listings below and don't forget our special bulk purchase price reductions!

**Stage 1 (White) Universal**



Coarse - Reducing - EVE Universal - Silicone Mini Polishers - Stage 1

Metal reducing polishers

Great for:

- Precious metals (including alloys), including gold and silver
- Non precious metals (including alloys)
- Titanium
- Platinum
- Stainless steel
- Porcelain
- Acrylics
- Enamel
- Ceramics

Features:

- Grit: coarse
- Colour: White
- Composition: Silicone
- Recommended RPM: 7000 to 10,000 (Max 20,000 RPM)
- Ø2.35mm shank

Mandrels:

- Screw on mandrels see code P1343M
- Threaded mandrels see code M4817

Code	Description	UOM	Price
P1315C	(1) Wheel Ø17 x 2.5mm	EACH	£0.35
P1315D	(1) Wheel Ø17 x 6mm	EACH	£0.50
P1315A	(1) Wheel Ø22 x 3mm	EACH	£0.36
P1315B	(1) Wheel Ø22 x 6mm	EACH	£0.65
P1315E	(2) Bullet Ø6 x 21mm	EACH	£0.36
P1315G	(3) Knife Ø18 x 4mm	EACH	£0.40
P1315F	(3) Knife Ø22 x 4mm	EACH	£0.40
P1315H	(4) Cylinder Ø7 x 21mm	EACH	£0.40
P1315I	(4) Cylinder Ø9 x 21mm	EACH	£0.45
P1315J	(4) Cylinder Ø12 x 21mm	EACH	£0.56
P1315K	(4) Cylinder Ø14 x 25mm (5mm hole)	EACH	£0.84
Price breaks available, see website			

**Stage 2 (Black) Universal**

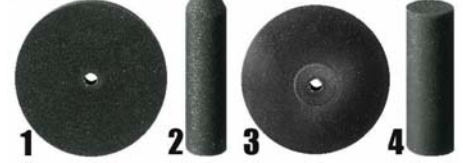

Pre-Polish - Smoothing - EVE Universal - Silicone Mini Polishers - Stage 2

Metal pre-polishing & smoothing polishers

Great for:

- Precious metals (including alloys), including gold and silver
- Non precious metals (including alloys)
- Titanium
- Platinum
- Stainless steel
- Acrylics

Features:

- Grit: Medium
- Colour: Black
- Composition: Silicone
- Recommended RPM: 7000 to 10,000 (Max 20,000 RPM)
- Ø2.35mm shank

Mandrels:

- Screw on mandrels see code P1343M
- Threaded mandrels see code M4817

Code	Description	UOM	Price
P1316C	(1) Wheel Ø17 x 3.5mm	EACH	£0.35
P1316D	(1) Wheel Ø17 x 6mm	EACH	£0.50
P1316A	(1) Wheel Ø22 x 3.5mm	EACH	£0.36
P1316B	(1) Wheel Ø22 x 6mm	EACH	£0.65
P1316E	(2) Bullet Ø6 x 21mm	EACH	£0.36
P1316G	(3) Knife Ø18 x 4mm	EACH	£0.36
P1316F	(3) Knife Ø22 x 4mm	EACH	£0.36
P1316H	(4) Cylinder Ø7 x 21mm	EACH	£0.40
P1316I	(4) Cylinder Ø9 x 21mm	EACH	£0.45
P1316J	(4) Cylinder Ø12 x 21mm	EACH	£0.56
P1316K	(4) Cylinder Ø14 x 25mm (5mm hole)	EACH	£0.84
Price breaks available, see website			

**Stage 3 (Light Blue) Universal**

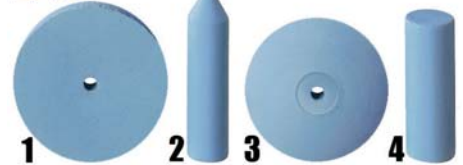

Final Finish - EVE Universal - Silicone Mini Polishers - Stage 3

Final finish, high lustre polishers

Great for:

- Precious metals (including alloys), including gold and silver
- Non precious metals (including alloys)
- Acrylics

Features:

- Grit: Fine
- Colour: Light blue
- Composition: Silicone
- Recommended RPM: 7000 to 10,000 (Max 20,000 RPM)
- Ø2.35mm shank

Mandrels:

- Screw on mandrels see code P1343M
- Threaded mandrels see code M4817

Code	Description	UOM	Price
P1317C	(1) Wheel Ø17 x 3.5mm	EACH	£0.35

**EVE POLISHERS - SILICON**

Silicon polishers are very soft so they adapt better to the surface you are working on better than other polishers. They are easier to handle and provide an all over even finish.

- Universal - For use on a variety of precious metal alloys. The white stage 1 polishers can also be used on ceramics, acrylic and other metals
- Pumice - For use on any jewellery already containing set precious, non precious & synthetic stones. The special composition of these polishers ensure no damage to the stone, as well as providing a light buffer

Stages:

- Stage 1: Coarse Reducing
- Stage 2: Pre-Polish & Smoothing
- Stage 3: Final Finish (including matt & satin finish)
- Stage 4: Super High Lustre Finish

EVE silicone finishers are leaders through innovation, quality, and precision.

These silicone-bonded general-purpose polishers, work quickly and efficiently on



Online Discounts

<b>P1317D</b>	(1) Wheel Ø17 x 6mm	EACH	<b>£0.50</b>
<b>P1317A</b>	(1) Wheel Ø22 x 3.5mm	EACH	<b>£0.36</b>
<b>P1317B</b>	(1) Wheel Ø22 x 6mm	EACH	<b>£0.65</b>
<b>P1317E</b>	(2) Bullet Ø6 x 21mm	EACH	<b>£0.40</b>
<b>P1317G</b>	(3) Knife Ø18 x 4mm	EACH	<b>£0.40</b>
<b>P1317F</b>	(3) Knife Ø22 x 4mm	EACH	<b>£0.40</b>
<b>P1317H</b>	(4) Cylinder Ø7 x 21mm	EACH	<b>£0.40</b>
<b>P1317I</b>	(4) Cylinder Ø9 x 21mm	EACH	<b>£0.45</b>
<b>P1317J</b>	(4) Cylinder Ø12 x 21mm	EACH	<b>£0.56</b>
<b>P1317K</b>	(4) Cylinder Ø14 x 25mm (5mm hole)	EACH	<b>£0.84</b>
Price breaks available, see website			

### Universal Stage 3 (Blue) Matt

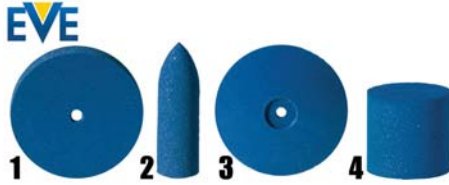

Matt Final Finish - EVE Universal - Silicone Mini Polishers - Stage 3

Matt final finish, high lustre polishers

Great for:

- Precious metals (including alloys), including gold and silver
- Non precious metals (including alloys)
- Titanium
- Platinum
- Stainless steel
- Porcelain
- Acrylics
- Enamel
- Ceramics

Features:

- Grit: Fine
- Colour: Blue
- Composition: Silicone
- Recommended RPM: 7000 to 10,000 (Max 20,000 RPM)
- Ø2.35mm shank

Mandrels:

- Screw on mandrels see code P1343M
- Threaded mandrels see code M4817

Code	Description	UOM	Price
<b>P42351</b>	(1) Wheel Ø17 x 2.5mm	EACH	<b>£0.35</b>
<b>P42352</b>	(1) Wheel Ø17 x 6mm	EACH	<b>£0.50</b>
<b>P42353</b>	(1) Wheel Ø22 x 3mm	EACH	<b>£0.35</b>
<b>P42354</b>	(1) Wheel Ø22 x 6mm	EACH	<b>£0.65</b>
<b>P42355</b>	(2) Bullet Ø6 x 24mm	EACH	<b>£0.35</b>
<b>P42356</b>	(3) Knife Ø22 x 4mm	EACH	<b>£0.35</b>
<b>P42357</b>	(4) Cylinder Ø7 x 20mm	EACH	<b>£0.35</b>
<b>P42358</b>	(4) Cylinder Ø7 x 20mm	EACH	<b>£0.45</b>
<b>P42359</b>	(4) Cylinder Ø14 x 20mm	EACH	<b>£0.55</b>
<b>P42360</b>	(4) Cylinder Ø14 x 25mm (5mm Hole)	EACH	<b>£0.85</b>
Price breaks available, see website			

### Stage 4 (Pink) Universal



Super High Lustre Finish - EVE Universal - Silicone Mini Polishers - Stage 4

Super high lustre polishers

Great for:

- Precious metals (including alloys), including gold and silver
- Non precious metals (including alloys)

• Acrylics

Features:

- Grit: Extra fine
- Colour: Pink
- Composition: Silicone
- Recommended RPM: 7000 to 10,000 (Max 20,000 RPM)
- Ø2.35mm shank

Mandrels:

- Screw on mandrels see code P1343M
- Threaded mandrels see code M4817

Code	Description	UOM	Price
<b>P1318C</b>	(1) Wheel Ø17 x 2.5mm	EACH	<b>£0.35</b>
<b>P1318D</b>	(1) Wheel Ø17 x 6mm	EACH	<b>£0.50</b>
<b>P1318A</b>	(1) Wheel Ø22 x 3mm	EACH	<b>£0.35</b>
<b>P1318B</b>	(1) Wheel Ø22 x 6mm	EACH	<b>£0.62</b>
<b>P1318E</b>	(2) Bullet Ø6 x 21mm	EACH	<b>£0.40</b>
<b>P1318G</b>	(3) Knife Ø18 x 4mm	EACH	<b>£0.40</b>
<b>P1318F</b>	(3) Knife Ø22 x 4mm	EACH	<b>£0.40</b>
<b>P1318H</b>	(4) Cylinder Ø7 x 21mm	EACH	<b>£0.40</b>
<b>P1318I</b>	(4) Cylinder Ø9 x 21mm	EACH	<b>£0.45</b>
<b>P1318J</b>	(4) Cylinder Ø12 x 21mm	EACH	<b>£0.56</b>
<b>P1318K</b>	(4) Cylinder Ø14 x 25mm (5mm hole)	EACH	<b>£0.84</b>
Price breaks available, see website			

### Pumice Stage 2 (Honey)



Pre-Polish - Smoothing - EVE Pumice - Silicone Mini Polishers - Stage 2

Metal pre-polishing & smoothing polishers for jewellery containing stones

Great for:

- Jewellery containing stones
- Precious metals (including alloys), including gold and silver
- Non precious metals (including alloys)
- Precious and synthetic stones

Features:

- Grit: Medium
- Colour: Honey
- Composition: Silicone
- Recommended RPM: 7000 to 10,000 (Max 20,000 RPM)
- Ø2.35mm shank

Mandrels:

- Screw on mandrels see code P1343M
- Threaded mandrels see code M4817

Pumice is a natural product therefore the colours/shades can vary

Code	Description	UOM	Price
<b>P42361</b>	(1) Wheel Ø12 x 2mm	EACH	<b>£0.55</b>
<b>P42362</b>	(1) Wheel Ø22 x 3mm	EACH	<b>£0.55</b>
<b>P42363</b>	(2) Knife Ø15 x 2.5mm	EACH	<b>£0.55</b>
<b>P42364</b>	(2) Knife Ø22 x 4mm	EACH	<b>£0.55</b>
<b>P42365</b>	(3) Bullet Ø5 x 16mm, mounted	EACH	<b>£0.90</b>
<b>P42366</b>	(4) Wheel Ø14.5 x 2mm, Mounted	EACH	<b>£0.95</b>
<b>P42367</b>	(5) Knife Ø14.5 x 2mm, mounted	EACH	<b>£1.00</b>
Price breaks available, see website			

### Pumice Stage 3 (Grey)



Pre-Polish - Smoothing - EVE Pumice - Silicone Mini Polishers - Stage 3

Final finish, high lustre polishers for jewellery containing stones

Great for:

- Jewellery containing stones
- Precious metals (including alloys), including gold and silver
- Non precious metals (including alloys)
- Precious and synthetic stones

Features:

- Grit: Fine
- Colour: Grey
- Composition: Silicone
- Recommended RPM: 7000 to 10,000 (Max 20,000 RPM)
- Ø2.35mm shank

Mandrels:

- Screw on mandrels see code P1343M
- Threaded mandrels see code M4817

Pumice is a natural product therefore the colours/shades can vary

Code	Description	UOM	Price
<b>P42368</b>	(1) Wheel Ø12 x 2mm	EACH	<b>£0.55</b>
<b>P42369</b>	(1) Wheel Ø22 x 3mm	EACH	<b>£0.55</b>
<b>P42370</b>	(2) Knife Ø15 x 2.5mm	EACH	<b>£0.55</b>
<b>P42371</b>	(2) Knife Ø22 x 4mm	EACH	<b>£0.55</b>
<b>P42372</b>	(3) Bullet Ø5 x 16mm, mounted	EACH	<b>£0.85</b>
<b>P42373</b>	(4) Wheel Ø14.5 x 2mm, mounted	EACH	<b>£0.95</b>
<b>P42374</b>	(5) Knife Ø14.5 x 2mm, Mounted	EACH	<b>£0.95</b>
Price breaks available, see website			

## FELTS, MOUNTED & NON MOUNTED

COUSINSUK



Cousins UK - UK Made

Felts, mounted and non-mounted, have a wide range of application are used in many industries. They have an excellent resilience and last longer when in use.

Used with the appropriate compounds you can get a high standard, semi-bright mirror finish.

- Felts are very popular for jewellers, silversmiths, light engineers, model makers and in arts and crafts
- They can be used on a whole range of metals such as gold, silver, platinum, titanium, palladium, copper, brass, aluminium and steel
- They are very useful for getting into spherical awkward circular areas, inside rings and bangles for example
- They can be mounted onto rotary headpieces or spindles in order to reach awkward areas (see below for recommended rotary machines)
- Are a very economical and extremely efficient method for batch work

## Felts (Mini), Mounted

Cousins UK - UK Made

Best quality, traditional soft felt. Soft felt wheels can be used on a vast array metals and other surfaces; gold, silver, platinum, copper, brass etc. Provides an all round, even finish, precision made, excellent quality

Size :

- Mounted on 3/32" or 2.35mm shank
- Overall length 50mm

Recommend compounds

- P1388 Dialux Rouge
- P7809 Platinum Final Finish Polinum Polishing Compound
- P1394 Hyfin Final Finish Compound
- P1410 Tripoli General Purpose Polishing Compound

Recommended rotary machines:

- Foredom Grinder Micromotor Kit: FDK1020
- Jewellers Kit & No20 "Quick Release" Handpiece: K2220CE
- Rotary Drill & Tool Kit, Variable Speed: D9821

- Ø11mm
- Length 20mm

Code	Description	UOM	Price
P1310M	Cone (Ø11mm) Mounted	EACH	£0.78

## Knife (Ø21mm) Mounted

COUSINSUK



- Felt
- Ø21mm

Code	Description	UOM	Price
P1306M	Knife (Ø21mm) Mounted	EACH	£0.82

## 3 Fold (Ø21mm) Mounted

COUSINSUK



- Soft Felt
- 3 Folds
- Ø21mm

Code	Description	UOM	Price
P1304M	3 Fold (Ø21mm) Mounted	EACH	£0.95

## 3 Fold (Ø22mm) Mounted, Non UK Made

VALUE



- Soft Felt
- 3 Folds
- Ø22mm

Code	Description	UOM	Price
P40211	3 Fold (Ø22mm) Mounted, Non UK Made	EACH	£0.25
Price breaks available, see website			

## Barrel (Ø10mm) Mounted

COUSINSUK



- Felt
- Ø10mm
- Length 14mm

Code	Description	UOM	Price
P31657	Barrel (Ø10mm) Mounted	EACH	£0.78

## Inverted Cone (Ø14mm) Mounted

COUSINSUK



- Felt
- Ø14mm
- Length 15mm

Code	Description	UOM	Price
P1309M	Inverted Cone (Ø14mm) Mounted	EACH	£0.78

## Bud (Ø9mm) Mounted

COUSINSUK



- Felt
- Ø9mm
- Length 12mm

Code	Description	UOM	Price
P1307M	Bud (Ø9mm) Mounted	EACH	£0.65

## Pear (Ø10mm) Mounted

COUSINSUK



- Felt
- Ø10mm
- Length 15mm

Code	Description	UOM	Price
P31656	Pear (Ø10mm) Mounted	EACH	£0.78

## Felts (Mini), Non Mounted

COUSINSUK



Unmounted felts are even more economical and cost effective for your manufacturing needs.

- Hard White Felt
- Various diameters and thickness's
- Mount onto tapered spindle, code P1343M
- Made in India / UK

Recommend compounds

- P1388 Dialux Rouge
- P7809 Platinum Final Finish Polinum Polishing Compound
- P1394 Hyfin Final Finish Compound
- P1410 Tripoli General Purpose Polishing Compound

Recommended rotary machines:

- Foredom Grinder Micromotor Kit: FDK1020
- Jewellers Kit & No20 "Quick Release" Handpiece: K2220CE
- Rotary Drill & Tool Kit, Variable Speed: D9821

Code	Description	UOM	Price
P31653	Knife (Ø22mm) UK Made	EACH	£0.62
P39300	Knife (Ø25mm)	EACH	£0.50
P39308	Wheel (Ø15 x 3mm)	EACH	£0.45

## Bullet (8mm) Mounted

COUSINSUK



- Felt
- Ø8mm
- Length 16mm

Code	Description	UOM	Price
P1308M	Bullet (8mm) Mounted	EACH	£0.78

## Cone (Ø11mm) Mounted

COUSINSUK



- Felt

## Wheel (Ø21mm) Mounted

COUSINSUK



- Felt
- Ø21mm
- Thick 4.5mm

Code	Description	UOM	Price
P1305M	Wheel (Ø21mm) Mounted	EACH	£0.80

<b>P31654</b>	Wheel (Ø22 x 6mm) UK Made	EACH	<b>£0.78</b>
<b>P39309</b>	Wheel (Ø25 x 3mm)	EACH	<b>£0.50</b>
<b>P39310</b>	Wheel (Ø25 x 6mm)	EACH	<b>£0.60</b>
Price breaks available, see website			

## MANDRELS



We supply a large range of mini mandrels all of which are mounted on a Ø3/32" or Ø2.35mm shank. Additionally please see our comprehensive selection of none mounted attachments which fit these. It is always advisable to stock extra Mini Mandrels; changing attachments can be time consuming during demanding periods.

Please note: always wear safety glasses and when mounting a mini mandrel onto a rotary hand piece it is undesirable to allow the mandrel to protrude too far from the collet, as heavier weighted items can bend the mandrel. Ideally leave a minimum of 15mm of mandrel from the collet to the mounted bit for the ultimate rotary performance.

### Pin Collet Mandrels



- To take Ø3.00mm Eve pin polishers
- Also will tighten to hold Ø2.35mm or 3/32" mounts
- Easy wind on thread attachment

- For use with EVE pin polishers:
- X-hard bond, medium grit (P19813)
  - Hard bond, coarse grit (P19814)
  - Medium bond, medium grit (P19815)
  - Medium bond, fine grit (P19816)
  - Medium bond, x-fine grit (P19817)
  - Medium bond, xx-fine grit (P19818)

Code	Description	UOM	Price
<b>P39477</b>	Pin Polisher Mandrel, Cousins	EACH	<b>£1.50</b>
<b>P19812</b>	Pin Polisher Mandrel, EVEFLEX	EACH	<b>£4.25</b>
Price breaks available, see website			

[www.cousinsuk.com](http://www.cousinsuk.com) Online Discounts

### Screw On Mandrels

Mandrel Screw on type

- Used with a wide variety of disc abrasive polishing attachments
- Screw on with ease for removal and fixing the abrasive polishing attachment of your choice
- Ø2.35mm Shank
- Ø3.00mm Shank (M32972 & M47015)
- M20875 & M47015 - Ø8mm diameter head, useful for thin & brittle disks

Suitable for a wide variety of consumables including:

- Paper Polishing Wheels
- Cutting Disks
- Silicon Polishers (Wheels and Knife edges)
- Radial Bristle Wheel

#### Ø2.35mm Shank (Parallel), Ø5mm Screw



- Mounted on a Ø2.35mm (3/32") Shank

Code	Description	UOM	Price
<b>P1343M</b>	Ø2.35mm Shank (Parallel), Ø5mm Screw	EACH	<b>£0.75</b>

#### Ø2.35mm Shank (Stepped), Ø5mm Screw



- Mounted on a Ø2.35mm (3/32") Shank

Code	Description	UOM	Price
<b>M32971</b>	Ø2.35mm Shank (Stepped), Ø5mm Screw	EACH	<b>£0.95</b>

#### Ø2.35mm Shank (Stepped), Ø8mm Screw



- Ø8mm diameter head, useful for thin & brittle disks
- Mounted on a Ø2.35mm (3/32") Shank

Code	Description	UOM	Price
<b>M20875</b>	Ø2.35mm Shank (Stepped), Ø8mm Screw	EACH	<b>£0.75</b>

#### Ø3.00mm Shank (Parallel), Ø5mm Screw



- Mounted on a Ø3.00mm Shank

Code	Description	UOM	Price
<b>M32972</b>	Ø3.00mm Shank (Parallel), Ø5mm Screw	EACH	<b>£0.95</b>

#### Ø3.00mm Shank (Stepped), Ø8mm Screw



Code	Description	UOM	Price
<b>M47015</b>	Ø3.00mm Shank (Stepped), Ø8mm Screw	EACH	<b>£0.95</b>
Price breaks available, see website			

### Screw On Mandrels, Mounted



Mandrel Screw on type - Mounted

- Used with a wide variety of disc abrasive polishing attachments
- Screw on with ease for removal and fixing the abrasive polishing attachment of your choice
- Mounted on wooden hub
- Can screw onto polishing machine mandrels
- Ø5mm bore diameter (approx.)
- Hub diameter Ø15mm

Suitable for a wide variety of consumables including:

- Paper Polishing Wheels
- Cutting Disks
- Silicon Polishers (Wheels and Knife edges)
- Radial Bristle Wheel

Code	Description	UOM	Price
<b>D39356</b>	Ø5mm Screw, Parallel Shank, Mounted	EACH	<b>£1.50</b>

### Snap On Mandrels



Snap on Paper Disc Mandrel

- Easy snap on filament for mounting and removing paper discs
- reduces time changing your paper polishing disc

Size:

- Length 45mm
- Mounted on a Ø3/32" or 2.35mm

Used with Paper Disks:

- Fine - P12615
- Medium - P12616
- Coarse - P12617

Code	Description	UOM	Price
<b>P12618</b>	Snap On Mini Disk Mandrel	EACH	<b>£2.95</b>
Price breaks available, see website			

### Split Mandrels

Split parallel & tapered mandrels, slotted for holding strips of abrasive paper or cloth.

- Split Mandrels are very useful to use for levelling off metals
- Any type of paper can be used with these mandrels, from course to fine
- Used on a wide range of metals including brass, copper, gold, silver, platinum, palladium, titanium, pewter, tin, steel, iron and aluminium.
- Using various paper grades you can level off the piece, smoothing scratches, pit holes, file and casting flash marks.
- Cut chosen abrasive paper into strips, feed into the split and wrap around the mandrel



ready for use.

- A high polishing finish is also achievable with your split mandrel by using very fine abrasive paper
- An economical way to do large batch work

## Parallel Split, Ø3.5mm



- Sizes:
- Ø3.5mm Cylinder
  - Length 50mm
  - 25mm Cylinder Body Length
  - 16mm Long Split
  - 0.50mm Split Gap
  - Mounted on a Ø3/32" or 2.35mm

Code	Description	UOM	Price
M32974	Parallel Split, Ø3.5mm	EACH	£0.95

## Parallel Split, Ø5mm



- Sizes:
- Ø5mm Cylinder
  - Length 60mm
  - 30mm Cylinder Body Length
  - 20mm Long Split
  - 0.65mm Split Gap
  - Mounted on a Ø3/32" or 2.35mm

Code	Description	UOM	Price
M9476	Parallel Split, Ø5mm	EACH	£0.75

## Tapered Split, Ø2.6 to Ø4.8mm



- Sizes:
- Ø2.6 to Ø4.8mm Cylinder
  - Length 65mm
  - 30mm Cylinder Body Length
  - 20mm Long Split
  - 0.60mm Split Gap
  - Mounted on a Ø3/32" or 2.35mm

Code	Description	UOM	Price
M32970	Tapered Split, Ø2.6 to Ø4.8mm	EACH	£0.95

## Tapered Split, Ø3.0 to Ø4.5mm



- Sizes:
- Ø3.0 to Ø4.5mm Cylinder
  - Length 65mm
  - 30mm Cylinder Body Length
  - 20mm Long Split
  - 0.75mm Split Gap
  - Mounted on a Ø3/32" or 2.35mm

Code	Description	UOM	Price
M4816	Tapered Split, Ø3.0 to Ø4.5mm	EACH	£1.50

Price breaks available, see website

## Threaded Taper Mandrel

Tapered Mandrels

- Easy wind on
- Used with a wide variety of dolly mops and felt cones
- Available in left and right taper, allowing correct direction rotation so your surface removal residue goes where you want it
- Large selection of dolly mops and felt cones available to fit
- for a conventional polishing motor use Taper Spindle Mounting Pin Vice D20130
- Size: Ø3/32" or 2.35mm shank mount
- M12605 large mandrel suitable for larger mini silicone polishers (e.g. P1316K, P1317K, P1318K)

Our selection of dolly mops and felt cones fitting these mandrels:

- P3571A & P3571B - Sisal Dolly Mop
- P3573A to P3573D - Aurelia (B Calico) Dolly Mop
- P3572A to P3572D - Riva (G Calico) Dolly Mop
- P3574A to P3574D - Swansdown Dolly Mop
- P3539 - 50 x 25mm Tapered Felt Cone
- P3540 - 45 x 22mm Bullnose Felt Cone
- P3542 - 45 x 16mm Conical Felt Cone

## Ø1.85mm Thread (Parallel) Right



- Sizes:
- With Tightening Nut
  - Mounted on a Ø3/32" or 2.35mm
  - Length 45mm
  - 15mm Threaded Length
  - Thread Ø1.85mm

Code	Description	UOM	Price
M32969	Ø1.85mm Thread (Parallel) Right	EACH	£0.95

Pin Chuck  
Adaptor & Collets

See Page 938



## Ø1.70mm to Ø3.00mm Thread, Right



- Sizes:
- Mounted on a Ø3/32" or 2.35mm
  - Length 45mm
  - 11mm Threaded Length
  - Thread Ø1.70mm up to Ø3.00mm

Code	Description	UOM	Price
M4817	Ø1.70mm to Ø3.00mm Thread, Right	EACH	£0.85

## Ø2.50mm to Ø5.00mm Thread, Left



- Sizes:
- Mounted on a Ø3/32" or 2.35mm
  - Length 63mm
  - 19mm Threaded Length
  - Thread Ø2.50mm up to Ø5.00mm

Code	Description	UOM	Price
P1344M	Ø2.50mm to Ø5.00mm Thread, Left	EACH	£2.00

## Ø2.50mm to Ø5.00mm Thread, Right



- Sizes:
- Mounted on a Ø3/32" or 2.35mm
  - Length 63mm
  - 19mm Threaded Length
  - Thread Ø2.50mm up to Ø5.00mm

Code	Description	UOM	Price
P1345M	Ø2.50mm to Ø5.00mm Thread, Right	EACH	£2.45

## Ø4.00mm to Ø6.00mm Thread, Right



- Sizes:
- Mounted on a Ø3/32" or 2.35mm
  - Length 58mm
  - 18mm Threaded Length
  - Thread Ø4.00mm up to Ø6.00mm
  - Suitable for larger mini silicone polishers (e.g. P1316K, P1317K, P1318K)

Code	Description	UOM	Price
M12605	Ø4.00mm to Ø6.00mm Thread, Right	EACH	£4.50

Price breaks available, see website

PRICE PROMISE  GUARANTEE

 TODAY SAME DAY DISPATCH

## PAPER DISCS, KEMDENT

### Paper Polishing Discs



Kemdent Paper Discs Made in United Kingdom

- can be used in wet and dry conditions
- a jewellery silversmith favourite mounting rotary abrasive
- very flexible as you are using them you will notice they will flex into your position of your desire
- suitable for grinding and polishing a wide range of materials gold, silver, copper, brass, platinum, palladium, bronze, pewter, aluminium and steel
- are very popular for jewellers, silversmiths, light engineers, model makers and in arts and crafts
- are a very economical and efficient method for batch work
- can be mounted onto rotary headpieces spindles in order to reach awkward areas (see below for recommended rotary machines)
- put a silicon disc on bottom (code P1316A) of your mandrel with the pin hole centre type (P1343M) and you will find you can push up and apply pressure to remove those awkward marks on the piece

Recommended rotary machines:

- Foredom Grinder Micromotor Kit: FDK1020
- Jewellers Kit & No20 "Quick Release" Handpiece: K2220CE
- Rotary Drill & Tool Kit, Variable Speed: D9821

For cleaning out and finishing into crevices and inaccessible areas of workpiece.

Pin Hole: Takes standard mandrel see our product code P1343M.

Hub Fitting: Takes snap on mandrel see our product code P12618.

- Paper polishing disks with pin hole or hub
- Ø22mm diameter
- Fine, Medium or Coarse
- Packs of 50 or 100
- Hub fitting disc use mandrel P12618
- Pin hole disc uses mandrel P1343M

Code	Description	UOM	Price
P12615	Fine (hub fitting) Paper Disc	PACK*50	£6.25
P12619	Fine (pin hole) Paper Disc	PACK*100	£7.95
P12616	Medium (hub fitting) Paper Disc	PACK*50	£6.25
P12620	Medium (pin hole) Paper Disc	PACK*100	£7.95
P12617	Coarse (hub fitting) Paper Disc	PACK*50	£6.25
P12621	Coarse (pin hole) Paper Disc	PACK*100	£7.95

Price breaks available, see website

Online Order Tracking

Rotary (Low Voltage) Drills

See Page 661



## RADIAL BRISTLE BRUSHES



### Radial Bristle Wheels

- Can be used for cleaning, finishing, polishing, pre polishing, texturing blending and fire scale removal
- Easily glide through small grooves, fine details and any awkward areas
- Available in various grades to handle delicate or harsher work for finishing
- Radial bristle wheels can be used on gold, silver, platinum, palladium, copper, brass, aluminium, pewter, tin, steel, and bronze
- Are very popular for jewellers, silversmiths, light engineers, model makers and in arts and crafts.
- Are very useful for getting into spherical awkward circular areas for example, inside bangles and certain sizes of rings
- Can be mounted onto rotary headpieces spindles in order to reach awkward areas (see below for recommended rotary machines)
- Mount up to 6 pieces of radial wheels on your mandrel, code P1343m. It not advised to mix the grades on one mandrel

### Why Bristle?

- Long life and consistent performance
- Conformability - Unlike conventional abrasives, bristle products are highly flexible and will penetrate and conform to irregular surfaces. You can be confident of a consistent uniform finish on even the most complex of pieces, saving you time and money

Recommended rotary machines:

- Foredom Grinder Micromotor Kit: FDK1020
- Jewellers Kit & No20 "Quick Release" Handpiece: K2220CE
- Rotary Drill & Tool Kit, Variable Speed: D9821

### Radial Bristle Brushes



### Cousins UK - Radial Bristle Wheels

- Can be used for cleaning, finishing, polishing, pre polishing, texturing blending and fire scale removal
- Easily glide through small grooves, fine details and any awkward areas
- Available in various grades to handle delicate or harsher work for finishing
- Radial bristle wheels can be used on gold, silver, platinum, palladium, copper, brass, aluminium, pewter, tin, steel, and bronze
- Ø16, 20 & 25mm available
- Can be used with standard screw mandrel, code P1343M

Radial bristle wheels contain no wire filaments, helping you to meet increasingly demanding safety standards. When used in place of compounds, they eliminate the issue of harmful chemical vapours, and significantly reduce clean-up time and effort.

Radial bristle thickness:

- Ø16mm has 0.40mm thick bristles
- Ø20mm has 0.60mm thick bristles
- Ø25mm has 0.90mm thick bristles

Recommended rotary machines:

- Foredom Grinder Micromotor Kit: FDK1020
- Jewellers Kit & No20 "Quick Release" Handpiece: K2220CE
- Rotary Drill & Tool Kit, Variable Speed: D9821

Code	Description	UOM	Price
P40189	Ø16mm (Grit 80) Dark Green	EACH	£0.50
P40192	Ø16mm (Grit 120) Blue	EACH	£0.50
P40195	Ø16mm (Grit 220) Brown	EACH	£0.50
P40198	Ø16mm (Grit 320) Chestnut	EACH	£0.50
P40201	Ø16mm (Grit 600) Purple	EACH	£0.50
P40204	Ø16mm (Grit 1000) Light Green	EACH	£0.50
P40190	Ø20mm (Grit 80) Dark Green	EACH	£0.50
P40193	Ø20mm (Grit 120) Blue	EACH	£0.50
P40196	Ø20mm (Grit 220) Brown	EACH	£0.50
P40199	Ø20mm (Grit 320) Chestnut	EACH	£0.50
P40202	Ø20mm (Grit 600) Purple	EACH	£0.50
P40205	Ø20mm (Grit 1000) Light Green	EACH	£0.50
P40191	Ø25mm (Grit 80) Dark Green	EACH	£0.50
P40194	Ø25mm (Grit 120) Blue	EACH	£0.50
P40197	Ø25mm (Grit 220) Brown	EACH	£0.50
P40200	Ø25mm (Grit 320) Chestnut	EACH	£0.50
P40203	Ø25mm (Grit 600) Purple	EACH	£0.50
P40206	Ø25mm (Grit 1000) Light Green	EACH	£0.50

Price breaks available, see website

### Radial Bristle Brushes, Scotch-Brite™



Manufactured by 3M - Scotch-Brite™ Radial Bristle Wheels

Scotch-Brite radial bristle discs replace alternative abrasives, wire brushes, chemicals and compounds for deburring, cleaning, finishing and polishing detailed parts or small areas. The 14mm and 19mm discs have exceptionally flexible bristles for improved conformability.

- Scotch-Brite 3M technology
- Can be used for cleaning, finishing, polishing, pre polishing, texturing blending and fire scale removal
- Easily glide through small grooves, fine details and any awkward areas
- Available in various grades to handle delicate or harsher work for finishing
- Radial bristle wheels can be used on gold, silver, platinum, palladium, copper, brass, aluminium, pewter, tin, steel, and bronze
- Ø14 & 19mm available
- Can be used with standard screw mandrel, code P1343M

Scotch-Brite bristle abrasives contain no wire filaments, helping you to meet increasingly demanding safety standards. When used in place of compounds, they eliminate the issue of harmful chemical vapours, and significantly reduce clean-up time and effort.

Radial bristle dimensions:

- Each radial bristle thickness 0.4mm
- Thickness of wheel 0.5mm

Recommended rotary machines:

- Foredom Grinder Micromotor Kit: FDK1020
- Jewellers Kit & No20 "Quick Release" Handpiece: K2220CE
- Rotary Drill & Tool Kit, Variable Speed: D9821

Code	Description	UOM	Price
P9608	Ø14mm (Grit 120) White	EACH	£0.80
P9609	Ø14mm (Grit 220) Red	EACH	£0.80
P9610	Ø14mm (Grit 400) Blue	EACH	£0.80
P9612	Ø19mm (Grit 80) Yellow	EACH	£0.80

<b>P9613</b>	Ø19mm (Grit 220) Red	EACH	<b>£0.80</b>
<b>P9614</b>	Ø19mm (Grit 400) Blue	EACH	<b>£0.80</b>
<b>P9615</b>	Ø19mm (Pumice) Pink	EACH	<b>£0.80</b>
Price breaks available, see website			

**STEEL WHEELS, TEXTURING**

**Steel Wheels, Texturing**

**VALUE**



Easily add some texture and pattern with steel texturing wheels. Create a beautiful textured finish-quickly and easily.

The wheels give the effect similar to the bark of a tree; however when applying different grades the wheel gives a completely unique look, this is due to the thickness of the wire, the thicker the wire the deeper the texture.

- Coarse, medium & fine
- Use dry, no compounds needed
- Used on a wide range of metals including brass, copper, gold, silver, platinum, palladium, titanium, pewter, tin, steel, iron and aluminium
- These texturing wheels have excellent wear and tear
- Very economical and an efficient method for batch work
- Gives a textured finish on rings, bracelets, pendants, bangles, brooches, cufflinks and tie pins
- Leaves a contrasting finish on jewellery.

Sizes (approx.):

- Overall diameter of wheel Ø17mm
- Length of each steel wire 5mm
- Centre plastic hub diameter Ø10mm
- Ø2.35mm shank

Code	Description	UOM	Price
<b>P40186</b>	Ø0.20mm Steel (Fine)	EACH	<b>£3.50</b>
<b>P40187</b>	Ø0.30mm Steel (Medium)	EACH	<b>£3.50</b>
<b>P40188</b>	Ø0.45mm Steel (Coarse)	EACH	<b>£3.50</b>
Price breaks available, see website			

**STONE GRINDERS & ABRASIVES, MOUNTED**

**Set of 12 Stone Grinders**



The Rotary 12 piece stone grinder set is an exceptional choice to smooth, shape/grind precious or non precious metals, glass and ceramics.

Impressive tooling at a value price

Some usages are...

- Remove excess solder
- Grind smooth deep file marks
- Casting surface flash imperfections
- Triblet indentations
- Precious metal testing, removing plating before testing
- Texturing metals
- Metal and glass engraving

Features:

Aluminium Oxide points mounted on 2.25mm (3/32") shanks and including storage box

8 x Pink grit 330 will refine to detail and smooth away in perfections

- 1 x taper cone size (4.4mm x 2.5mm x 13mm)
- 1 x long large parallel drum (6.3mm x 13mm)
- 1 x bud shape (6.3mm x 10mm)
- 1 x inverted cone (12mm x 5.5mm)
- 1 x knife edge (12.7mm x .8mm)
- 1 x disc wheel (12.8mm x 2.85mm)
- 1 x small parallel (3.5mm x 6.3mm)
- 1 x medium parallel (4.30mm x 7.4mm)

4 x Green grit 230 these specially designed points are ideal for grinding/shaping

- 1 x large bullet (18mm x 5mm)
- 2 x ball Shape (5mm)
- 1 x inverted cone (7mm x 4.4mm)

Code	Description	UOM	Price
<b>S33859</b>	12 Stone Grinders/Abrasives	PACK*12	<b>£5.95</b>

**Set of 36 Stone Grinders**



The Rotary 36 piece stone grinder set is an exceptional choice to smooth, shape/grind precious or non precious metals, glass and ceramics.

Impressive tooling at a value price

Some usages are...

- Remove excess solder
- Grind smooth deep file marks
- Casting surface flash imperfections
- Triblet indentations
- Precious metal testing, removing plating before testing
- Texturing metals
- Metal and glass engraving

Specifications:

- Aluminium oxide points
- Mounted on 2.25mm (3/32") shank
- Includes storage box
- Pack\*36
- Shapes include cylinder, ball, knife edge, bud, large disc wheel & small disc wheel
- Multiple grits

Code	Description	UOM	Price
<b>B39025</b>	36 Stone Grinders/Abrasives	PACK*36	<b>£14.95</b>

**Set of 100 Stone Grinders**



The Rotary 100 piece stone grinder set is an exceptional choice to smooth, shape/grind precious or non precious metals, glass and ceramics.

Impressive tooling at a value price

Some usages are...

- Remove excess solder
- Grind smooth deep file marks
- Casting surface flash imperfections
- Triblet indentations

# +

## Contact & Services

# Your direct line to our Management Team

*All correspondence is time stamped and answered within 1 hour of receipt*

## Instant Message Service

- Triblet indentations
- Precious metal testing, removing plating before testing
- Texturing metals
- Metal and glass engraving

Specifications:

- Aluminium oxide points
- Mounted on 2.25mm (3/32") shank
- Includes storage box
- Pack\*100
- Shapes include cylinder, ball, knife edge, bud, inverted cone, bullet, large disc wheel & small disc wheel
- Multiple grits

Code	Description	UOM	Price
B39026	100 Stone Grinders/Abrasives	PACK*100	£25.95

**WHEELS (BRISTLE, CALICO, CHAMOIS, COTTON NYLON) MOUNTED**



Bristle Wheels are very popular in the polishing industry some of the usages are:

- excellent for polishing / brightening over stone setting like fine pave work, channel settings, rub over / bezel settings etc
- you will find that the bristles will get in-between the stone setting hence added brightness to the setting
- use before rhodium finishing; you will notice an enhanced brighter finish
- very good to get into grooves and shapes
- available in various grades to handle delicate or harsher work for finishing
- bristle wheels can be used on gold, silver, platinum, palladium, copper, brass, plastics, aluminium, pewter, tin, steel, wood and bronze
- are very popular for jewellers, silversmiths, light engineers, model makers and in arts and crafts.
- are very useful for getting into spherical awkward circular areas for example, inside bangles
- can be mounted onto rotary headpieces spindles in order to reach awkward areas (see below for recommended rotary machines)

The Bristle Wheels have very good wear and last longer when in use, very economical for batch work; used with the right bar of compounds you can get a high standard, bright and semi bright finish.

Recommended compounds:

- P1388 Dialux Rouge
- P7809 Platinum Final Finish Polinum Polishing Compound
- P19467 Titanium & Stainless Steel Specialist Polinox Polishing Compound
- P1390 Steelbrite Final Finish Compound

Recommended rotary machines:

- Freedom Grinder Micromotor Kit: FDK1020
- Jewellers Kit & No20 "Quick Release" Handpiece: K2220CE
- Rotary Drill & Tool Kit, Variable Speed: D9821

**Bristle Wheels**



Cousins UK - UK Made

Traditional wheel bristle brushes have been the ideal manufactures' choice for many generations.

- Wheel bristle brushes are recommended for many types of metals; gold, silver, platinum, copper, brass etc.
- Perfect to reach around grooves, indentations or over flat surfaces
- Bristles are excellent to get into grooves, slits or uneven surfaces
- Precision made excellent quality
- Ø13mm x 10mm
- Max 10,000rpm
- Made in Britain

P1290M- Semi Finish, use P1394

P1289M-Smoothing, use P3664

Code	Description	UOM	Price
P1290M	Ø21mm (Black) Medium	EACH	£0.48
P1289M	Ø21mm (White) Stiff	EACH	£0.60

Price breaks available, see website

**Bristle Wheels, Alpine**



Cousins UK - UK Made

Bristle "Alpine" wheels a new selection of miniature wheel brushes with HP shanks.

For all kinds of polishing of precious metal alloys, acrylic teeth, non precious metal alloys, hard alloys, composite, ceramics, etc. Superior quality than conventional wheel brushes which sometimes can fall apart

- Excellent for polishing / brightening over stone setting like fine pave work, channel settings, rub over / bezel settings etc
- You will find that the Alpine Wheel bristles will get in-between the stone setting hence added brightness to the setting
- Use before rhodium finishing; you will notice an enhanced brighter finish
- Very good to get into grooves and shapes
- Available in various grades to handle delicate or harsher work for finishing
- Bristle wheels can be used on gold, silver, platinum,

palladium, copper, brass, plastics, aluminium, pewter, tin, steel, wood and bronze

- Are very popular for jewellers, silversmiths, light engineers, model makers and in arts and crafts.
- Are very useful for getting into spherical awkward circular areas for example, inside bangles
- Can be mounted onto rotary headpieces spindles in order to reach awkward areas (see below for recommended rotary machines)
- Max 8,000rpm
- Made in UK

The Bristle Wheels have very good wear and last longer when in use, very economical for batch work; used with the right bar of compounds you can get a high standard, bright and semi bright finish.

Recommended compounds:

- P1388 Dialux Rouge
- P7809 Platinum Final Finish Polinum Polishing Compound
- P19467 Titanium & Stainless Steel Specialist Polinox Polishing Compound
- P1390 Steelbrite Final Finish Compound

Recommended rotary machines:

- Freedom Grinder Micromotor Kit: FDK1020
- Jewellers Kit & No20 "Quick Release" Handpiece: K2220CE
- Rotary Drill & Tool Kit, Variable Speed: D9821

Code	Description	UOM	Price
P30564	Ø19mm (Grey) Extra Soft	EACH	£0.60
P30563	Ø19mm (White) Soft	EACH	£0.60
P30562	Ø19mm (Brown) Medium	EACH	£0.60
P30561	Ø19mm (Black) Hard	EACH	£0.60

Price breaks available, see website

**Calico Wheels**



Cousins UK - UK Made

Calico Wheels Mounted have a fine tight cloth weave.

- Mill treated, hard 100% pure cotton, similar to 'g' quality. Enhances cut without loss of head retention.
- The most popular starting mini mop in the polishing industry.
- A medium grade of loose fold mini mop.
- Also known in the trade as a grease buffing mini mop.
- When you use a calico wheel they hold their shape very well and you can push up your pieces to get into those awkward areas.
- An ideal mini mop to level your metal such as scratches, pit holes, file and casting flash marks.
- Mounted on a Ø2.35mm shank.
- Max 10,000rpm

The Calico Wheel Ø21mm Mounted has very good wear and last longer when in use.

Very good to do large batch loads of work with economical spending.

Used with the right bar of compounds you can get a high standard semi bright finish.

Recommended compounds

- P1410 Tripoli General Purpose Polishing Compound
- P1384 Dialux blue
- P3664 Tripolea 2468
- P1394 Hyfin

Code	Description	UOM	Price
P1303M	Ø21mm (Calico) Mounted	EACH	£0.85

Price breaks available, see website



## Chamois Wheels



Cousins UK - UK Made

Mini Chamois Wheel Mounted:

- 100% best grade buffalo hide leather
- Gives a very traditional superior mirror finish to the contemporary mop; use the Chamois Wheel wet with rouge powder (P8984) for gold and silver!
- Very popular finishing mini mop in the polishing industry.
- A fine grade of loose fold mini mop.
- These Chamois Wheel mini mops hold their shape well; you can push up your pieces to get into difficult to reach areas with effective results.
- Also known in the trade as a mirroring quality mini mop
- are very popular for jewellers, silversmiths, clock makers / repairers, light engineers, model makers plastic fabricators and for arts and crafts
- can be used on a whole range of materials such as gold, silver, copper, brass, pewter, prosthetic plastics, bronze and steel
- 4 layers of fine leather held with a strong metal press mount
- Mounted on a Ø2.35mm shank
- Max 10,000rpm

The chamois leather mini mops have excellent durability and ideal for batch work and economical. Furthermore, using these mops with the below compounds you can achieve a high standard mirror finish.

Recommended compounds:

- P1388 Dialux Rouge
- P7809 Platinum Final Finish Polinum Polishing Compound
- P19467 Titanium & Stainless Steel Specialist Polinox Polishing Compound
- P1390 Steelbrite Final Finish Compound

Code	Description	UOM	Price
P1302M	Ø21mm (Chamois) Mounted	EACH	£0.94
Price breaks available, see website			

## Cotton Wheels



Cotton Wheels Mounted 100% pure cotton, excellent for final mirror finishing.

Cotton wheels mounted are final finishing mops. Use this mop as the last stage mini mop to brighten your final finish to a high lustre. Also known for a very high grade of mirror finishing.

- Extremely popular for jewellers, silversmiths, light engineers, model makers and in arts and crafts
- Cotton wheels can be used on a whole range of metals such as gold, silver, platinum, titanium, palladium, copper, brass, aluminium and steel
- Very useful for getting into spherical awkward circular areas for example, inside rings and bangles
- One of the most popular final finishing mini mops in the polishing industry

- Also known in the trade as a mirroring quality mini mops
- Will hold shape well even under pressure and in tight spaces
- You will find the our cotton wheels will maintain durability whilst still offering a quality high final mirror finish
- An ideal mini mop get the expert finishing mirror shine on your work
- Mounted on a Ø2.35mm shank
- Max 10,000rpm

Used with the right compound, you can get a very high standard mirror finish.

Recommend compounds:

- P1388 Dialux rouge
- P1397 AA rouge
- P3659 Britelea FF9
- P7809A Platinum superior final finish polishing compound

Code	Description	UOM	Price
P40229	Ø24mm (Cotton) Mounted	EACH	£0.45
P1301M	Ø24mm (Cotton) Mounted, Made in UK	EACH	£0.68
M44291	Ø24mm (Cotton) Mounted, Double Thick	EACH	£0.60
Price breaks available, see website			

## Goat/Horse Hair (Mix) Wheels



Cousins UK - UK Made

Goat and horse hair bristle brushes are mainly used for polishing up metal in between stone settings. The natural composition of the brushes ensure no damage to the stone and a high polish finish.

- Mounted on a Ø2.35mm shank
- Max 10,000rpm
- Made in UK

Recommended compounds:

- P31645 - Final finish, use P1388
- P31646 - Ultra finish, use p7809

Natural products so colours may vary

Code	Description	UOM	Price
P31645	Ø21mm (Goat/Horse Mix) Bristle	EACH	£0.57
P31646	Ø21mm (Horse) Bristle	EACH	£0.57
Price breaks available, see website			

## Goat/Horse/Hog Hair Stars



Goat, horse & hog hair star brushes are mainly used for polishing up metal in between stone settings. The natural composition of the brushes ensure no damage to the stone and a high polish finish. The star shape allows excessively easy access to grooves and slits, ensuring all areas of your work reaches the quality your customers expect

- Mounted on a Ø2.35mm shank
- Goat, horse or chungking (hog) hair
- Star shaped

- Great for use in jewellery making, modelling and dentistry

Natural products so colours may vary

Code	Description	UOM	Price
P40209	Ø22mm (Goat Hair) Star, Extra Soft	EACH	£0.30
P40208	Ø22mm (Horse Hair) Star, Medium	EACH	£0.30
P40207	Ø22mm (Hog Hair) Star, Stiff	EACH	£0.30
Price breaks available, see website			

## Muslin Wheels

Traditional muslin polishing wheel



- Muslin wheels can be used on a vast array metals and other surfaces; gold, silver, platinum, copper, brass etc.
- To be used for the final polish
- Yellow muslin
- Provides an all round, even finish
- Precision made, excellent quality
- Ø22mm x 4.5mm
- Ø2.35mm shank

Recommend compounds:

- P1388 Dialux rouge
- P1397 AA rouge
- P3659 Britelea FF9
- P7809A Platinum superior final finish polishing compound

Code	Description	UOM	Price
P40210	Ø22mm (Muslin) Mounted	EACH	£0.25
Price breaks available, see website			

## Nylon Wheels

Cousins UK - UK Made



Traditional wheel nylon brushes are perfect for cleaning plastics and prosthetics.

- Perfect to reach around grooves, indentations or over flat surfaces
- Bristles are excellent to get into grooves, slits or uneven surfaces
- Precision made excellent quality
- Ø21mm
- Mounted on a Ø2.35mm shank
- Max 10,000rpm
- Use with compound P3659 for a final finish
- Made in Britain

Code	Description	UOM	Price
P31644	Ø21mm (White Nylon) Mounted	EACH	£0.55
Price breaks available, see website			

## Wire (Brass or Steel) Wheels



Cousins UK - UK Made  
Brass Wire Wheels...

- Brass brushes are recommended for soft metals such as gold, silver, brass and bronze
- Chains can be cleaned safely, easily for getting into awkward areas
- Perfect for antique silverware and medal renovation
- Mounted on a Ø2.35mm shank
- Max 10,000rpm
- Made in Britain

Cousins Brass Wire Wheels are made from 100% brass. They are very popular and used to clean up or for texturing various types of metals. The fine grade of wire gives a smooth shiny finish.

When using these fine brass wire wheels you should use soap or a detergent with water as a lubricant otherwise a dull layer of brass will be deposited on your metal particularly on silver.

The brass wires of the brush can penetrate deep recesses still giving an equal finish to a flat surface, without disrupting the shape of the piece; producing a brilliant finish with very little effort.

Brass brushes will not damage your pieces.

Steel Wire Wheels...

- Are very popular for jewellers, silversmiths, clock makers/repairers, light engineers, model makers and for arts and crafts
- Steel brushes are recommended for hard metals such as aluminium, carbon steel, gilding metals and stainless steel
- Are very economical and an efficient method for batch work
- Can clean chains safely and get into awkward areas easily
- Are perfect for antique silverware and medal renovation

Cousins Steel Wheel are made from 100% best grade steel. They are used to clean up or for texturing various types of metals.

The fine grade of wire gives a smooth and shiny finish; these lines have proven to be very popular, due to their low cost and efficiency.

The bristles of the wheel can penetrate deep recesses, but still give an equal finish to a flat surface, without disrupting the shape of the piece; producing a brilliant shiny finish with very little effort.

Steel wheel brushes will not damage the piece(s).

Code	Description	UOM	Price
P1292M	Ø21mm (Brass) Coarse	EACH	£0.65
P1291M	Ø21mm (Steel) Coarse	EACH	£0.65

Price breaks available, see website

 **OVER 130,000 DIFFERENT ITEMS**

**Drill & Tool Kit**

See Page 661



**Flexible Drive Shaft**

See Page 660



**Cousins Popular "Euro" Burrs**

See Page 811

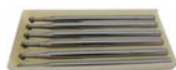

**Greiner Poseidon LT-100 Water Testing Machine**  
• Pressure & Vacuum To 10 Bar



Ref: W9680 See Page: 756

**ROXER Natator 40 Water Testing Machine**  
• Wet Test To 40 Bars



Ref: W12350 See Page: 757

**witschi Chronoproof Pro Water Testing Machine**  
• Intergrated Compressor To 3 Bars



Ref: W36030 See Page: 757

**Elma Solvex VA Cleaning Machine**



Ref: R37628 See Page: 739

**Elma Solvex RM Cleaning Machine**



Ref: R37629 See Page: 742

**Elma Solvex SE Cleaning Machine**



Ref: R37630 See Page: 742